

\$3.50

PROFILES

September 1985
Magazine for Kaypro Users

Discovering Treasures

CP/M educational
software

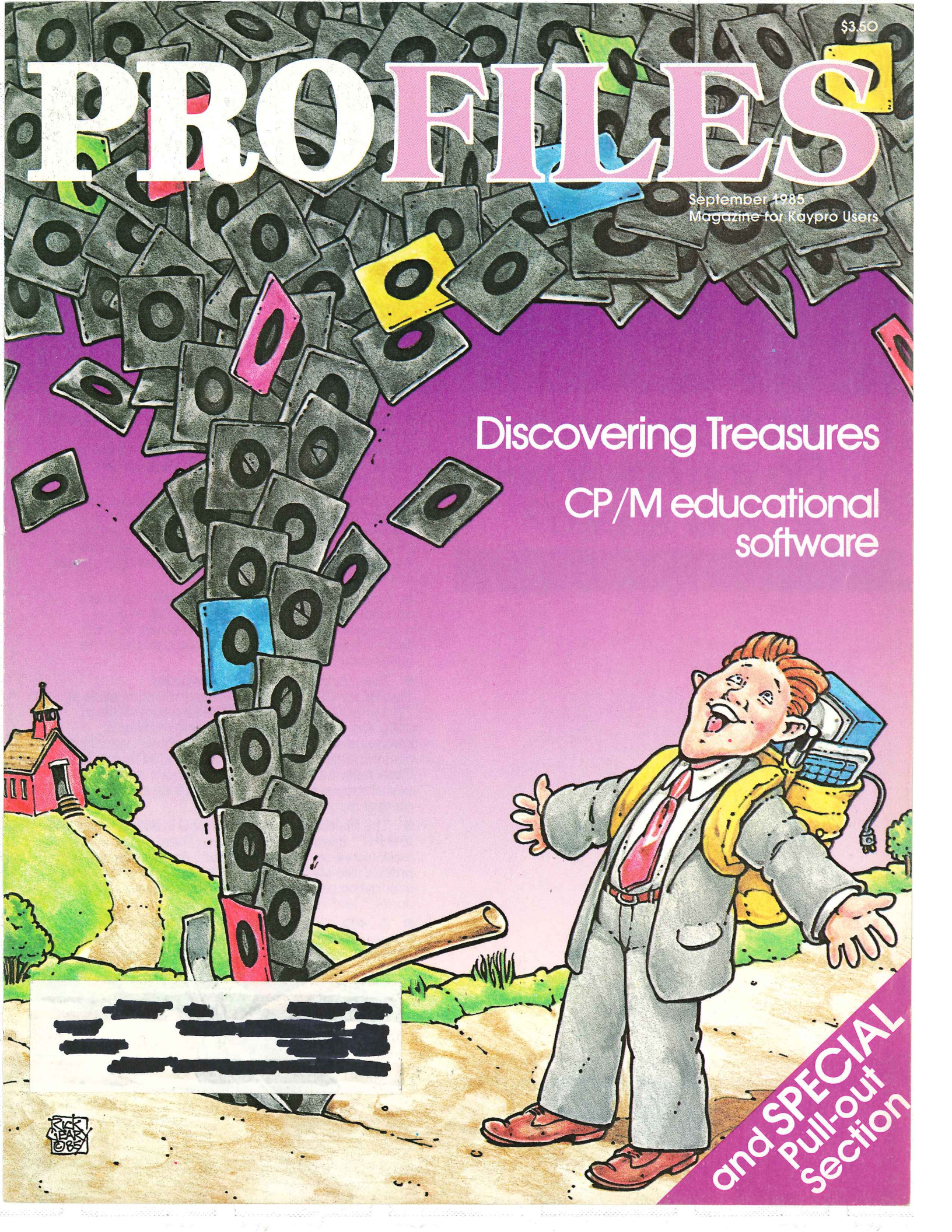

[Redacted text]



and SPECIAL
Pull-out
section

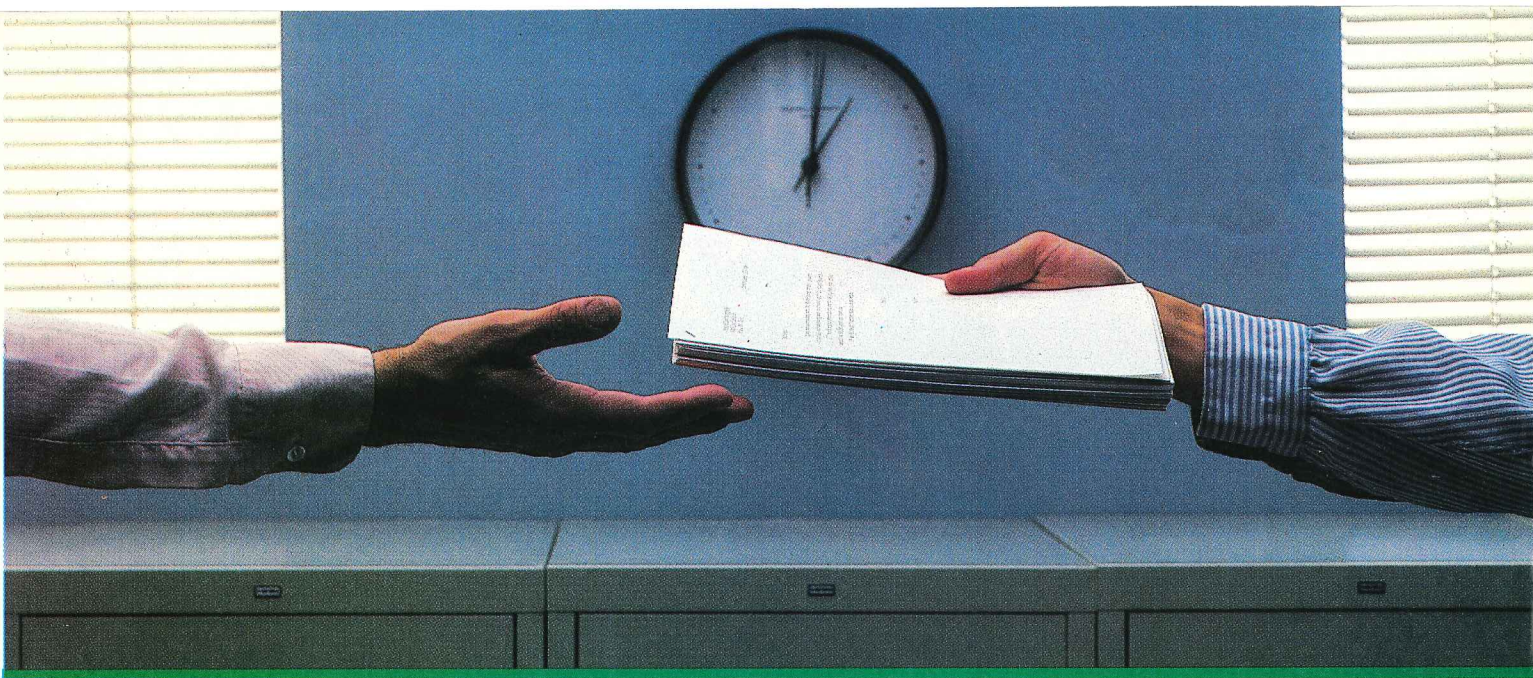

2400 bps modems: Do you Really need another speed?

- Is the shift from 300 to 1200 bps going to repeat itself at 2400 bps? The answer is both yes and no. There certainly are applications for 2400 bps asynch dial-up modems, but we shouldn't expect 1200 bps to die overnight.
- 2400 bps modems can improve throughput, thereby getting tasks done quicker and more economically. However, 1200 bps has become the virtual standard for professional dial-up communications, and most users are satisfied with it. So why consider a 2400 bps modem at all?
- One reason is flexibility. If the modem you select operates at all three speeds (300, 1200 & 2400) in accordance with accepted industry standards, it will serve virtually all dial-up applications now and in the foreseeable future.
- The modem you select should be the MultiModem224. It is Bell 212A and 103 compatible at 1200 and 300 bps, and CCITT V.22bis compatible at 2400. It is also 100% compatible with the Hayes command set, meaning that it will work with virtually all communications software packages, at all three speeds. Other features include both synchronous and asynchronous operation, full intelligence and a phone number memory.
- The MultiModem224 is available in both desktop and IBM PC™ internal card versions. (There is also a rack-mounted version for central sites.) And as a bonus, we provide free offers from ten of the most popular on-line information services, including CompuServe™, Dow Jones™ and The Source™.
- A 2400/1200/300 bps modem is just a plain good investment. Why not let the MultiModem224 provide your communications for both today and tomorrow?

MultiTech
Systems 

The right answer every time.

82 Second Ave. S.E., New Brighton, MN 55112 (612) 631-3550, TWX: 910-563-3610

MultiTech
Systems 

MultiModem 224
2400/1200/300 BPS Intelligent Modem



IS YOUR PRINTER'S RHAPSODY MAKING YOU BLUE?

NEW PRODUCT

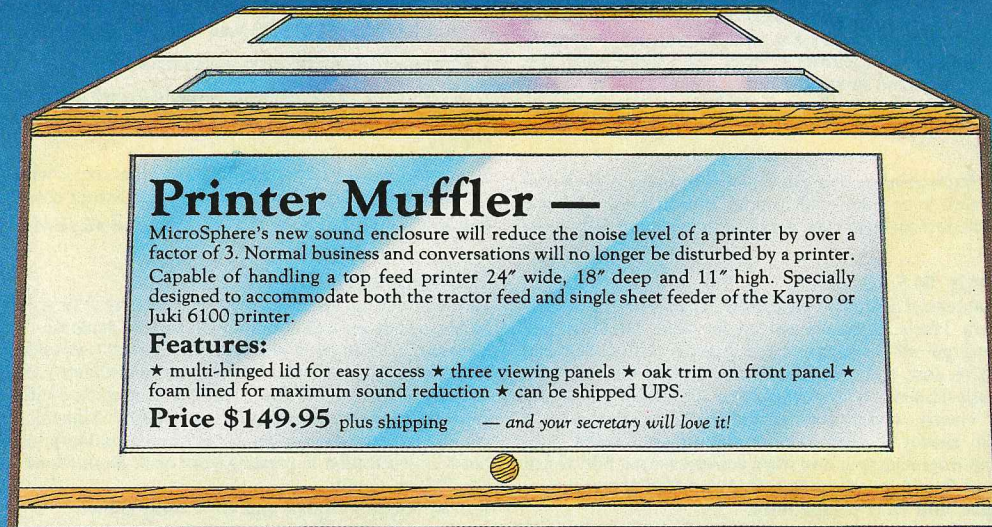

Printer Muffler —

MicroSphere's new sound enclosure will reduce the noise level of a printer by over a factor of 3. Normal business and conversations will no longer be disturbed by a printer. Capable of handling a top feed printer 24" wide, 18" deep and 11" high. Specially designed to accommodate both the tractor feed and single sheet feeder of the Kaypro or Juki 6100 printer.

Features:

★ multi-hinged lid for easy access ★ three viewing panels ★ oak trim on front panel ★ foam lined for maximum sound reduction ★ can be shipped UPS.

Price \$149.95 plus shipping — and your secretary will love it!

KAYPRO 16

256 to 512 Memory Upgrade Kit	\$69.95
512 to 640 Memory Upgrade Kit	CALL
Improved Character ROM: Clear, easy to read new Character Set	\$29.95
TLC Lisp — with turtle graphics	\$250.00

Kaypro 1, 2X, 2-84, 4-84, 10

IBM-PC type external monitor adapter, simultaneous dual screen operation, just as sharp and clear as internal screen	\$49.95
--	---------

Electronic RAM Disk and Printer Buffer Combination—the ultimate add-on for Kaypro I, II, 4-84, 2-84 and 2X Computers.

Unprecedented speed and efficiency are offered using MicroSphere's dual operation Electronic RAM disk and printer buffer. No longer will you need to wait for your Kaypro to slowly finish mundane tasks such as running a printer or waiting for floppy drives to turn when you have better things to do.

Features:

Can be powered externally ★ 255 directory entries ★ 10 MHz microprocessor speed
Compatible with Pro 8 and Plu-Perfect or 5 MHz speed up kits ★ Choice of drive A or E
RAM disk memory not lost on cold boot or reset of Kaypro
Printer buffer runs independently of RAM disk operation
Printer buffer sizes available: 4K, 32K, 64K

Any RAM Disk listed below can be expanded to 1mb by adding memory chips.

Standard RAM Disk without RAM Chips	\$295.00
56K RAM Disk	\$395.00
12K RAM Disk	\$495.00
58K RAM Disk	\$595.00
1MB RAM Disk	\$695.00

When ordering, specify computer model and printer buffer size.

	4MHz	Kaypro
	Floppy	RAM
Perfect Calc 14K Perfect Calc	9:31.25	1:17.78
Load LADDER.COM	9.38*	2.12*
Load Printer Buffer		
WK file, 11 pages, 2586 words		
Printing PIP to the LST device		24.61*
Time in seconds		
Modulator		\$25.00

Monitors

Description	Model	Price
Composite 12" Amber	122	\$119
Composite 12" Green	123	\$114
Quadram 12" Amber Chrome		
IBM/PC Type		\$195

CATALOG & COMPLETE DESCRIPTIONS AVAILABLE!

9-5 Pacific Time
Dealer inquiries invited.

MicroSphere, Inc.
P.O. Box 1221
Bend, Oregon 97709
503-388-1194



Kaypro is a registered trademark of the Kaypro Corporation TLC® LOGO is a trademark of LISP Company

TLC LOGO FOR BACK TO SCHOOL

Easy and exciting language for all ages. TLC LOGO is an exceptionally complete logo with vectors, multiple turtles, full floating point decimals and extremely fast program execution.

TWO VERSIONS OFFERED:

STANDARD version using only internal graphics of Kaypro I, 2-84, 4-84, 2X and 10; no hardware additions or modifications required; 16,000 pixel resolution. \$99.95

DELUXE version for all Kaypro Computers that have the MicroSphere Color Graphics board. Features 16 colors, 32 sprites, 49,000 pixel resolution and utilities such as screen dump to printer or disk. \$129.95

Special: Color Board & Deluxe TLC Logo \$199.95

Infocom ADVENTURE Games/ Kaypro or PC Format

2 Zork 1	\$34.95	2 Enchanter	44.95
3 Zork 2	39.95	3 Infidel	39.95
3 Zork 3	39.95	3 Sorcerer	39.95
4 Deadline	44.95	1 Seastalker	34.95
4 Starcross	44.95	2 Cutthroats	34.95
4 Suspended	44.95	2 Hitchhikers	34.95
2 Witness	44.95	3 Suspect	39.95
2 Planetfall	44.95		

LEVELS: 1=Jr., 2=Standard, 3=Advanced, 4=Expert
INVISICLUES available at \$7.95 each for all above games.

VIDEO GENERATOR FOR KAYPRO

Note: Dual Screen means internal Kaypro screen and external monitor work at the same time.
1. Kaypro I, 2-84, 2X, 4-84, 10 standard composite video \$89.95
2. New Kaypro 1, 2-84, 4-84, 2X, 10 IBM type external monitor, dual screen operation \$49.95
3. Older Kaypro 2 & 4, standard composite video, dual screen operation \$49.95

A NEW DIMENSION FOR KAYPRO COMPUTERS Color Graphics Board. Features 16 colors, 32 sprites, 256x192 bit mapped graphics. Software includes 3 editors, drivers and routines to access graphics system. Utilities include screen dump to disk and printer. Dual screen operation.

Color Board for Kaypro I, II, 4, 2-84, 2X, 4-84, 10 and Robie \$145.00

INSTANT GRAPHER 2.0 (For use with Color Graphics Board) Creates bar charts, stacked bar charts, hi/low, line graphs from keyboard, Perfect Calc, CalcStar or text files. \$40.00

Professional software for your Kaypro at low, low prices.

Proportional Spacing. Now in Version 3.0. Only \$22.95

A program that automatically installs your WordStar to print in proportional spacing *and* right justified margin. This means such letters as "i" and "l" will occupy much less space than letters like "m" and "w," and the space between words will be evenly spread out. As a result, every document you print, every letter you send out from your office will be dramatically improved in printout appearance and look almost *typeset!* Moreover, you can continue to print in right justification, boldface, shadow print, underscore, superscript, subscript, and a combination of these features while in proportional spacing mode. Best results are achieved when you use a PS printwheel, but fine even if you use the ordinary non-PS 10, 12, or 15-pitch printwheels. No crowded characters, even on one-word short lines. Comes with a disk and a manual plus a variety of printing tricks. Requires Kaypro, Juki, Brother, Silver-Reed, Star PowerType or any other letter-quality printers. Simply the best of its kind on the market at any price!

Extra Bonus for Juki 6100 printer: Our Proportional Spacing program will also automatically install your Juki 6100 to print French cedilla (ç) and German umlaut (ü), two foreign characters not on your keyboard. Now your

Mailing List. Only \$15.95

Just load it and start data entry! Extremely easy to use. Then print 1, 2, 3, or 4 across standard Avery labels. Specially set up for your DataStar and MailMerge, so you will get all the sophisticated features of DataStar and MailMerge: Add, delete, sort, and update your list anytime. Can sort *any* field. Number of records limited only by your disk capacity. Many tricks and tips included in our clearly written manual. Originally developed for a magazine subscription agency to keep track of more than 100,000 subscribers. Why waste time creating your own when you can use our fully tested and debugged program? *Requires at least DataStar and MailMerge to run.* For all Kaypro models and IBM compatibles.

Juki 6100 can print all the diacritical marks needed for French and German. Detailed instructions on how to print the other four special characters (¢ § — £) on Juki printwheels are included in our manual.

Now, Version 3.0 with more features added:

1. Allows you to install up to four different kinds of printwheels, including the new Juki Standard PS and the 15-pitch Mini Majestic (sold below).
2. Can print your NEW WORD files in proportional spacing and right justified margin.
3. Detailed instructions on how to customize our program, if necessary, to produce a printout that suits your own personal taste.
4. Professionally printed and bound manual.
5. More printing tricks explained in plain English (not computerese) by our in-house printer specialist for you to take full advantages of your letter-quality printers.

Note: The Kaypro Letter-quality printer that comes with your Kaypro 2X is the same as the Juki 6100 in every aspect except color.

For Kaypro II, 2, 2X, 4, 10, 16, 286i, and all IBM compatibles.

Bibliography. Only \$15.95

An electronic marvel for modern scholars and writers! Just call it up and start building your own electronic bibliography database. Then print in MLA, Chicago, Traban, or any other styles. Specially set up for your DataStar and MailMerge, so you can add, delete, sort, and update your bibliographic items anytime. Can sort *any* field. Number of records limited only by your disk capacity. Many tricks and tips discussed in our Manual. Used by the author in his Ph.D. dissertation on medieval Chinese military institutions. Saves you hours of frustration in creating your own. *Requires at least DataStar and MailMerge to run.*

For all Kaypro models and IBM compatibles.

Genuine Juki 6100 printwheels (100 characters). Only \$22.95 each.

Roman PS	The Quick Brown Fox Jumps Right Over The Lazy Dog. [\] ^ ` { } ~
Standard PS	The Quick Brown Fox Jumps Right Over The Lazy Dog. [Ω] Δ ° ½ ¶ ¼ ²
Caroll OCR 12	The Quick Brown Fox Jumps Right Over The Lazy Dog. [Ω] Δ ° ½ ¶ ¼ ²
Mini Standard 12/15	The Quick Brown Fox Jumps Right Over The Lazy Dog. [Ω] Δ ° ½ ¶ ¼ ²
Mini Majestic 12/15	The Quick Brown Fox Jumps Right Over The Lazy Dog. [Ω] Δ ° ½ ¶ ¼ ²
Joan Italic 10/12	The Quick Brown Fox Jumps Right Over The Lazy Dog. [Ω] Δ ° ½ ¶ ¼ ²

Note: Only Courier 10, Prestige Elite 12, and Roman PS are in the Juki Sequence and only these three can produce diacritical marks for French and German. The rest are in the Special Sequence and capable of printing other substitute characters as shown above. We now carry a full line of 18 genuine Juki-brand printwheels. You can order any Juki printwheel not listed here. Printwheel catalog will be sent free with any order.

Public Domain Disk. Only \$9.95

Our software engineer has fully tested and assembled a disk full (191K) of the finest CP/M programs now in the public domain. Saves you time and money to collect these on your own. Includes KSTROKES (a SmartKey-like program), SCREEN DUMP, NEW SWEEP, KMODEM, UNERASE, and much more.

Absolutely a must. **For Kaypro CP/M models only.**

Juki 6300 printer. List price \$995.00. Our price Only \$749.00

Our in-house printer specialist fell in love with this latest baby from Juki. Highly recommended to those looking for a high-speed letter-quality printer. Prints at 40 characters per second, in 10, 12, 15 pitch and proportional spacing! Uses 96-character Diablo printwheels and ribbon. 16-inch wide platen. Fully compatible with all Kaypro models, including Kaypro 16 and 286i, and our Proportional Spacing program. One-year manufacturer's warranty. FREE UPS shipping. No sales tax when shipped out of New Jersey.

CHAUCER SOFTWARE

16 Greenbrier Row
P.O. Box 2308
Princeton, NJ 08540
Telephone (609) 734-9016

CHAUCER SOFTWARE

P.O. Box 2308 Princeton, NJ 08540

Dear Chaucer, please *rush* me the following in 24 hours:

Description	Price
<input type="checkbox"/> Proportional Spacing	_____
<input type="checkbox"/> Mailing List	_____
<input type="checkbox"/> Bibliography	_____
<input type="checkbox"/> Printwheel	_____
<input type="checkbox"/> Public Domain Disk	_____
<input type="checkbox"/> Juki 6300 printer	_____

Subtotal _____

NJ residents only, add 6% sales tax _____

First Class Postage **\$2.00** _____

Foreign orders add \$10 for Air Mail _____

TOTAL _____

Check Enclosed VISA MasterCard

Card # _____

Exp. Date _____ Signature _____

Name _____

Address _____

City _____ State _____ Zip _____

Kaypro Model _____ Printer _____

PROFILES

Volume 3, Number 2
September 1985
The Magazine for Kaypro Users



No More Books 26

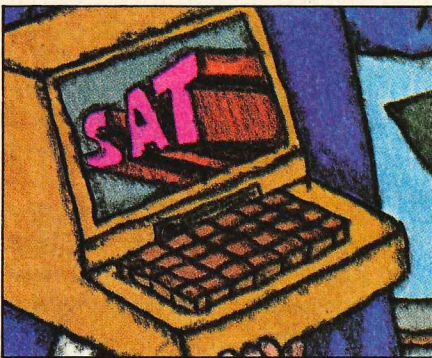

Acing SAT 34



Ultimate Speed-Up 52

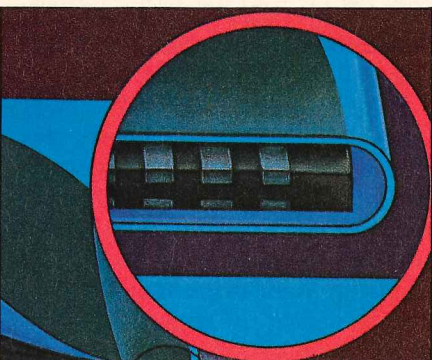

DU 59

Cover illustration by Rick Geary

DEPARTMENTS

About PROFILES	4
Letters	6
Q & A	10
Technical Forum	84
New Products	86
Advertisers' Index	89

FEATURES

No More Pencils, No More Books	26
<i>by Jim Spickard</i> Sampling CP/M educational software	
Acing the SAT	34
<i>by Benson Wong and Mary DeDanan</i> Practice offers competitive edge	
The Ultimate Computer Speed-Up	52
<i>by Sarah Wernick</i> Learn to touch type	
DU to the Rescue	59
<i>by Ted Silveira</i> Part 1: Into the jungle	
Disk Drive Diagnostics	68
<i>by Pieter Burggraaf</i> Anticipating diskaster	

COLUMNS

Editor's Notes	14
<i>by Tom Foote</i>	
Life at 300 Baud	16
<i>by Brock Meeks</i>	
Flea Market	20
<i>by Ted Silveira</i>	

Educational Software

Exercise for the mind

- over 40 packages
- English, Math, SAT, Geometry Chemistry Calculus, etc.
- For all popular micros
- Proven over 10 years



Resource Software International

800-526-2396
in NJ (201)738-8500

Free Catalogue



330 New Brunswick Ave.
Fords, NJ 08863

About PROFILES

PUBLISHER

Geoffrey W. Soule

EDITOR

Tom Foote

SENIOR EDITOR

Terian Tyre

MANAGING EDITOR

Diane Ingalls

TECHNICAL EDITOR

Tom Enright

CONTRIBUTING EDITORS

Ted Silveira

Dick Lutz

Brock Meeks

ART DIRECTOR

Doug Powell

ART ASSISTANT

Lorraine Leung

ASSISTANT PUBLISHER

Gwyn Price

CIRCULATION

Mary Boggy

CIRCULATION/EDITORIAL OFFICES

533 Stevens Avenue

Solana Beach, CA 92075

619/481-4353

ADVERTISING

Nancy Donabedian

249 S. Highway 101, Suite 321

Solana Beach, CA 92075

619/436-6112

PROFILES (ISSN 8775-464X) is published ten times a year by Kaypro Corporation, Solana Beach, California. Registered owners of Kaypro computers, within the United States, are entitled to a six-issue introductory subscription. Subscriptions within the United States are available for \$25.00 per year to people who are not registered Kaypro computer owners and for introductory subscription renewals.

Copyright © 1985 by Kaypro Corporation. All rights reserved. Reproduction without express written consent of the publisher is strictly prohibited. Second Class postage pending at Solana Beach, CA, and at additional mailing offices.

POSTMASTER: PLEASE SEND ALL CHANGES OF ADDRESS (FORM 3579) TO PROFILES, P.O. BOX 2889, DEL MAR, CALIFORNIA 92014.

Subscriptions

General subscription information can be found on page 15. If your subscription is due to expire, we'll notify you by mail. No subscription will be cancelled until you are given a chance to renew. Our basic one-year rate is \$25 (for ten issues).

If your first issue does not arrive within eight weeks *after* you've sent in your warranty card, or you miss an issue, please write to: *PROFILES*, Circulation Dept., P.O. Box 2889, Del Mar, CA 92014. We'll extend your subscription or send the issue.

To direct *PROFILES* to a new address, attach a recent mailing label plus both your old and new addresses. Allow six to eight weeks for processing.

If you have any other problem with your subscription or billing, *please* let us know at the above (Circulation) address so we can solve it promptly.

Disclaimer

Reviews, editorial references, and advertisements should not be taken as endorsements of any products not specifically manufactured by Kaypro Corporation. Opinions expressed are those of individuals and do not represent any form of corporate certification. Nor do they necessarily reflect intensive technical analysis as would be provided by a professional testing firm.

Responsibility for advertised products lies with the advertisers. Though we will not knowingly publish fraudulent materials, we are not liable for any damages arising from the purchase or use of any products. Should there be any consumer complaints regarding goods or services purchased from our advertisers, we would appreciate written notification to that effect to aid our own screening.

ACCOUNTING FOR MICROS

\$395 Set of Four
\$325 Set of Three
\$465 Set of Five

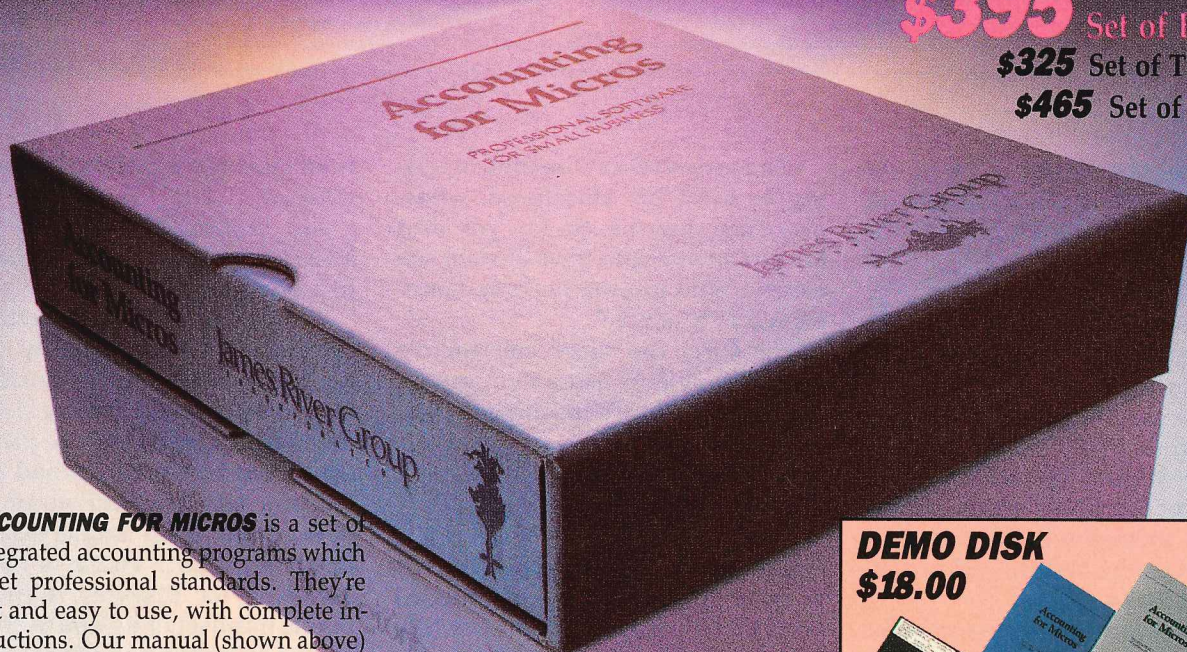

ACCOUNTING FOR MICROS is a set of integrated accounting programs which meet professional standards. They're fast and easy to use, with complete instructions. Our manual (shown above) also includes helpful information on bookkeeping and computers.

GENERAL LEDGER \$125
 Allows up to 1,000 accounts & 1,000 transactions/month. Retains mo/end balances for Last year, This Year and Forecast. Includes Cash Disbursements, Cash Receipts and General Journals. Reports include Balance Sheet, Income Statement, Annual Summaries and Journal Reports.

ACCOUNTS RECEIVABLE \$125
 Allows up to 2,500 customers and 1,000 invoices per month. Invoicing can access Inventory Module. Keeps customer names and addresses. Invoice prints on plain paper or any pre-printed form. Statements can be printed at any time.

INVENTORY \$125
 Allows up to 4,000 parts. Keeps 3 month history of unit sales as well as year to date. With AR, can be used as point of sale system (prints invoices, handles cash). Reports include Inventory Value and Stock Report, Internal and Customer Price List.

ACCOUNTS PAYABLE \$125
 Allows up to 500 vendors and 600 invoices/mo. Records invoices and handwritten checks. Prints computer checks on any pre-printed form. Keeps vendor names and addresses.

PAYROLL \$125
 Will handle up to 100 employees with eight deductions per employee. Deductions may be determined as fixed dollar amounts or percentages, or referred to a table for automatic look-up. Tax tables are easily entered, or purchased separately. Prints checks and W2's.

SET OF FIVE \$465
SET OF FOUR \$395
SET OF THREE \$325

RUN ON MOST CPM AND MSDOS

Apple CPM	IBM PC,XT,PC jr,AT	Sanyo (all)
Columbia	Kaypro (all)	Tandy (all)
Compaq	Morrow (all)	TeleVideo
Corona	Osborne (all)	Zenith 100 & 150
Eagle (all)	Panasonic	8" CPM
Epson QX-10	Radio Shack CPM	Other compatibles

DEMO DISK \$18.00



Try all 5 programs above (GL, AR, AP, IN, PR). Order our DEMO DISK for \$18.00 (includes shipping). Condensed versions of the programs give you the "feel" of data entry and access. Includes sample reports and instructions. Specify machine.

TMAN \$125
 The "Catch-All" program. Files any type of information for quick access. Name or subject oriented with 15 lines of notes per name. Use TMAN as a mailing list, filing system, notebook, etc. Can be used alone or with data from our other programs.
 Try **TMAN DEMO \$16**

HOW TO ORDER: Please specify machine and disk format. You can pay by check, by VISA or MasterCard (we need your expiration date and card number), or by UPS COD (add \$2.50 COD charge). Our price includes shipping. Minnesota residents, add 6% sales tax). We ship most orders the same day.
 or **ORDER BY PHONE: 612-339-2521**

James River Group
 I N C O R P O R A T E D



(612) 339-2521

125 North First Street
 Minneapolis, MN 55401

Letters

Letters to the editor should be mailed to PROFILES, 533 Stevens Avenue, Solana Beach, CA 92075.

Corrections

In the June 1985 introduction to "Life at 300 Baud" (page 24), the phone number for the Kaypro National Users' Group BBS should have been (516) 747-8308. And in the July/August introduction to the table of WordStar patch points (page 41), we meant the number for Wayne Master's Potpourri to be (408) 378-7474.

We regret any inconvenience the incorrect phone numbers may have caused.

Yahoos vs. byteheads?

William Fankboner's polemic (in Letters, June 1985) against the "yahoos" who do not share his enthusiasm for electronic esoterica was edifying. I didn't realize that my "pernicious herd insecurity" was showing! Indeed, without the programs that came in the box with my Kaypro, I can't even spell pernicious.

He typifies the deep division between "yahoos" (I prefer to be called a user) and "byteheads" (if he apologizes for yahoo, I'll call him a hobbyist). To me, as a user, my computer is no more interesting than my circular saw. What interests me is that it, like the saw, is an effective tool. What it does for me is far more important than how it does it.

Stephanie Goble
Glendale, Arizona

If I'd had any real doubts about the value of *PROFILES*, your June issue resolved them: you received the Fankboner Stamp of Disapproval, which is *my* stamp of approval.

Please don't ever consider changing to meet his standards, whatever they may be. So far, you and *Micro Cornucopia* have earned the award. Who knows, he may honor even *BYTE* next! ^

For sure, the more worthwhile the magazine to users as a group, the more certain is his disapproval.

Jim Roley
Hemet, California

You've gotten guff recently in this column for pandering to yahoos instead of passing on worthwhile technical information. This suggests a corollary to McHolm's Law: "Every owner of computer equipment thinks his is the center of the universe."

As a writer, the CP/M WordStar 3.3 is at the center of mine, and I appreciate the collection of WordStar patches and DDT instruction by Ted Silveira and Tom Enright in your July/August issue. I look forward to future trailblazing.

Yahoo! Yahoo! Yahoo!

Jim Polson
Wilmington, North Carolina

What's wrong with this picture?

My children, ages 7 and 9, enjoy the "How Many Things Can You Find Wrong in This Picture?" game. I played it with them using the July/August cover of *PROFILES*.

They found:

- diskettes not in their protective covers
- no labels on the diskettes
- no master, backup and working copy color dots (a local custom)
- diskettes too close to magnetic sources (telephone, keyboard)
- a cold cup that could sweat and ruin the neighboring diskette
- potential heat/cold damage

from storing diskettes too close to a window

—a keyboard sitting on a diskette (or at least it looked that way to a 7-year-old).

I added that the diskettes are probably contaminated by graphite, paper dust, eraser crumbs, ink for the listing, and tractor feed hold cutouts, and that they're probably scratched by the steno pad spring binding and deteriorated by ultraviolet light from being stored in direct sunlight. There is also the potential for disaster if the telephone handset or a book is dropped on the diskettes or coffee is spilled.

For the new computer user, this cover was a subliminal invitation to disaster.

Ron Hale
North Little Rock, Arkansas

Though we intended that cover to be far more aesthetic than instructional, the solid instruction your letter provides is most important and much appreciated. Thank you. (We can't wait for the letters about this month's image of hitting diskettes with a pick-axe.)

The Third World: who cares?

Nobody gives a damn about micros in the Third World or the "Disappeared Ones" in Argentina. How about more service pieces for using the Kaypro here in the U.S.A.? How about "What Makes a Kaypro Work" for the layman?

Dave Richieh
Los Angeles, California

Computer technology will only serve mankind adequately when computer use becomes a means to an end, rather than an end in itself. The last two issues of *PROFILES*

contained articles that illustrate future possibilities and thus serve a useful purpose far beyond that of helping the hacker/hobbyist.

The interview with Alvin Toffler and the article on telecommuting by Gil Gordon in the May issue and those in the June issue on micro-computer use in the third world and in tracking the "Disappeared Ones" in Argentina represent the type of writing that expands the reader's understanding so that more applications of computer technology become possible.

Herbert C. McKee
Houston, Texas

Like, totally awesome

Your July/August 1985 issue was "killer"; great articles. I hope someone's saved a special place in heaven for Ted Silveira and the others he mentioned. His "WordStar Deluxe" resurrected my RX-80 from its dreary, pica-only doldrums. His WordStar patches worked like a charm.

Kudos also to William Hogan for his article on SUBMIT and to Tom Enright for his nifty little WordStar patch to zap that tiresome first graphic screen.

Richard Muzinich
Sacramento, California

Your article on customizing WordStar was dynamite. I had already ordered a printer buffer, but after testing the patch you suggested for MORPAT, I cancelled that order today. Saved \$300!

George E. Delury
New York, New York

Although I've been a Kaypro user for some time now, my subscription to *PROFILES* was just started with

the July/August issue, and I must let you know that the one article by Ted Silveira on customizing WordStar has been the most helpful of any I've read in the past year of

studying. His work alone would justify the existence of the magazine.

Steven Goldblatt
Philadelphia, Pennsylvania

Open the door to diskette compatibility with UniForm!

Just \$69.95 turns one of your floppy drives into a "look-alike" of most popular CP/M* computers.

UniForm is the easy and inexpensive way to enable your CP/M computer to *directly* read, write and format diskettes from the most popular CP/M micros. This innovative program actually emulates the desired foreign drive. Files that were previously incompatible work flawlessly with your own software tools, such as word processors, database managers and spreadsheets. In addition, you can transfer files to or from MS-DOS.**

Menu-driven UniForm is mastered in just minutes—simply load, select the proper diskette format and go! Operation of your software is unchanged. At just \$69.95, compatibility never cost so little!



UniForm is available from your local computer dealer or Micro Solutions.

For users of IBM PC, PC-XT, PC-AT or compatibles, UniForm-PC provides direct access to CP/M data diskettes. Also just \$69.95.

Trademarks:
*Digital Research
**Microsoft Corporation



MicroSolutions

125 South Fourth St.
DeKalb, IL 60115
815/756-3411

KAYPRO SOFTWARE

MBACOUNT/\$89.00: Small business double entry accounting. Up to 40 asset, 40 liabilities, 40 income, 80 expense & 20 capital accounts user assignable. Prints checks, P & L, balance sheet, chart of accounts, single account details, check ledger, etc. Generates a printable detail journal for audit trail.

A/R, A/P, PAYROLL INVENTORY: These programs are available as either stand alone software or MBACOUNT integrated modules. Stand alone **\$79.00 ea.** Integrated **\$50.00 ea.**

PROFBILL/\$149.00: Time keeping and billing for all professional people who bill at various hourly rates. Handles 400 clients, 10 partners/employees. Prints billings, statements, aged billings, partner/employee hours, etc. May be used stand alone or integrated with MBACOUNT.

SBACOUNT/\$79.00: Small business single entry system. Up to 99 income and 99 expense categories, user assignable. Prints checks, P & L (month, quarter, YTD), single account details, check ledger. Generates a printable income/expense journal for audit trail.

MAILLIST/\$89.00: Mailing list/filing program. 10 fields per record and up to 900 records per file, files limited only by disk space. Sort/print all or partial list by most fields on 1, 2, or 3 across labels on 80 col. printer. Search, add to, delete or edit by most fields.

MBADATA/\$89.00: A data/base-filing system usable without learning any special language or control codes. Up to 253 characters, 24 fields, 900 records per file. Sort, print, display any fields in any location in any order desired. Menu driven with step by step prompts!

STANFORM/\$79.00: Need to fill out pre-printed forms? Then this program was made for you! Generates programs for printing data in the proper location on any pre-printed form that will fit into your printer. Each form need be generated only once as it is saved on disk.

\$FINANCE/\$79.00: Personal finance, prints checks, posts to as many as 120 user assignable expense categories, posts checks & deposits, reconciles multiple checking accounts, etc. Similar program for up to 9 charge cards. Extracts/prints listings for various categories.

TOUCHTYP/\$49.00: Parallels high school/college level touchtyping course. Displays typos, final score. Timed speed drill mode. Electronic typewriter mode converts your printer to a one line memory electronic typewriter with settable margins, tabs, line spacing, etc.

MSBCHART/\$49.00: Prints alphabetized list of all variables & line numbers referenced in any program written in basic cross referenced to the line number where used. A godsend when writing or modifying basic programs.

Place your order or request **FREE** catalog by mail or if using COD or credit card, telephone anytime of the night or day. Add \$3.00 shipping & \$3.00 additional for COD. Shipment will be no later than next working day by 1st class mail. Californians must add 6% tax to prices.



Micro-Art Programmers

173 Birch Avenue, Cayucos, California 93430 Phone: (805) 995-2329

Letters

Ted Silveira's article, "WordStar Deluxe," was great. I encourage you to have more such articles in the future. The article by William Hogan, "The Best-Kept Secret in CP/M: Why Didn't Anybody Tell Me About SUBMIT?," will save me a lot of time in the future.

T. Crawford Honeycutt
Arlington, Virginia

The new Perfect software, pro and con

I appreciated the articles on the new Perfect software in your June issue. I am a confirmed user of Perfect Writer and, for some months now, I have been using version 2.0. I generally agree with the evaluation of PW 2.0 by Joseph Comanda and Michael Harney. I am happy I purchased the upgrade and find that it makes a good word processor even better. Though I find the slowness of the program and the copy protection real drawbacks, the new features, like the menus and the thesaurus, are really great improvements.

The article referred to the menus favorably, but did say that one drawback was the use of more keystrokes to execute commands. I have found that the Kaypro option for reconfiguring the keypad makes the execution of the PW 2.0 commands very easy.

Jim Hentges
New Rochelle, New York

The new Perfect Software is so slow and cumbersome that within two weeks of "playing" with it, I wrote to Thorn EMI to get my money back. It is not an "upgrade" from the old (to use their word). It is a "travesty" to sell this to anyone with a Kaypro II who is used to the old Perfect Software, which, with its few problems, is still a pretty

NEW WORD[®]

VERSION 2

\$100!

HERE ARE SOME OF THE FEATURES YOU GET:

- 30 day money back guarantee
- WordStar/MailMerge compatible — file, keystroke, command
- Mergeprint is standard — including conditionals (if, then, else)
- Displays underline, bold, & inverse on the screen*
- Unerase — delete a line by accident? Unerase it!
- Works from any user area
- Microjustified printing on dot-matrix printers

VISIT OR CALL YOUR KAYPRO DEALER TODAY

or

ORDER NOW!

(800) 932-2526 • (415) 932-2526 (CA only)

OR SEND CHECK OR MONEY ORDER TO:

Newstar Software, Inc.
1601 Oak Park Blvd.
Pleasant Hill, CA 94523

- send \$100 for Newword
- \$3.00 shipping & handling
- CA residents add sales tax
- VISA/MC accepted

*not supported on '83 or earlier Models 2 & 4
offer applies to Kaypro CP/M™ versions only
Newword, CP/M, WordStar, MailMerge are trademarks of
Newstar Software, Digital Research, and MicroPro



good bundle of software.

Clarency P. Cameron
Madison, Wisconsin

Appalled

While reading the July/August 1985 issue of *PROFILES* I was appalled to find such a libelous statement by William Hogan: "And what David Gerrold didn't tell you in April is that *Checks* is SLOW. It takes 97 seconds to close a file, exit to the system, and load *Checks & Balances* again."

That statement is clearly telling everyone that *Checks & Balances* is a very slow program—an outright lie . . . I suggest you and Mr. Hogan do timing tests on each and every program and SUBMIT file mentioned in his article. You will soon find that the time to exit *Checks & Balances* and re-enter it is average.

Patrick Lajko
President, CDE Software

Hogan responds

I regret Pat Lajko's irritation. As was clear from the article, I use *Checks & Balances* regularly. I found it easy to figure out, and hard to screw up.

"Slow" is a relative term and a personal one. The interest in customizing and patching WordStar is an example of user frustration with and desire for improvements in programs they regularly use and basically like.

"Fast" is also a relative term. Pat Lajko says in his ads that *Checks & Balances* is fast. Fast in comparison to what? On what machine? With what size of data file? He doesn't say. His statement, as was mine, is an expression of personal opinion . . .

Pat Lajko created a product which he sells. I bought it. I use it. I

have a personal opinion about it. I wish it worked faster than it does for me on my machine.

William Hogan
Burbank, California

We intend for the benchmark timings in our roundup of home accounting packages (scheduled for November) to better detail speed differences across several major competitors in this product class. □



Dot Matrix Made Beautiful

All the type in this ad was printed on an inexpensive dot matrix printer with Fancy Font, the program that works with almost any word processor to produce high resolution, proportionally spaced, letter quality printing.

No special hardware or installation is required, so you'll be using Fancy Font as soon as you get it.

Fonts, including Roman, Sans Serif, Bold, Italic, Script, Old English and more, from 8 to 24 points come standard with Fancy Font.

FLEXIBLE. Fancy Font comes with a complete set of over 1500 mathematical, foreign language and other special symbols.

Hundreds of additional fonts in sizes from 6 to 72 points are available, at a nominal additional charge, from our growing font library.

You can edit any character and also create your own characters or logos, up to 1 inch by 1 inch.

Powerful formatting features let you center, justify, wordwrap and type flush left or right, with or without running headers and footers—even with different fonts and sizes on the same line.

COST EFFECTIVE. You buy Fancy Font from your local dealer or direct from us, the software developers, for only \$180.

You get near typeset quality at a small fraction of the time and cost of using art or typesetting services.

Fancy Font runs on PC DOS, MSDOS and CP/M systems with Epson, Toshiba and compatible dot matrix printers.

You'll be turning out great looking reports, newsletters, presentations, letters, mathematical texts, overheads or invitations after getting your copy of Fancy Font. The applications are limited only by your imagination.

Call or write now to order Fancy Font or ask for additional information including actual samples and independent reviews.

CALL TODAY 1-800-351-0500 MasterCharge and Visa Accepted

SoftCraft, Inc.

222 State Street, Madison, WI 53703 (608) 257-3300

Fancy Font is a registered trademark of SoftCraft, Inc.

Q & A

by Tom Enright

We welcome and read all your letters. Some letters of general interest are printed in the Letters column; others are pleas for technical help. Questions that lend themselves to simple, concise answers are dealt with here, while more advanced topics develop into articles or discussions in the Technical Forum.

Due to the volume, we simply can't respond personally to requests for assistance. For questions requiring an immediate reply, you should contact your dealer. Kaypro Technical Support now gives priority to dealer calls. This means it may be difficult to get them on the phone. They are still at (619) 481-3920, or you can write to Kaypro Software Technical Support, P.O. Box N, Del Mar, CA 92014. Please include your daytime phone number in all correspondence.

Standard language

Somewhere I read that the Army, government, or whoever had developed a language versatile enough for use on everything from mainframes to minis. I got the impression that this was "the language of the future"; i.e., that it would become a standard. Do you know the name of this language?

Richard Hilliard
Pahoa, Hawaii

It sounds like you're talking about ADA. The Department of Defense felt that having everything written in the same language would be advantageous to the government. The result was that ADA was designed by a committee to do everything from accounting to real-time weapons control.

The language itself resembles PASCAL somewhat and is unbelievably complex—so complex

that a complete implementation for microsystems is unlikely. ADA compilers for micros are available, but all of them are subsets of the complete language.

As far as being "the" language of the future, I don't think so. Being a committee-designed language, ADA is very hard to program in—it's just too bloody complicated.

If you are looking for an ADA compiler, check a few issues of BYTE. You should find a couple of them advertised there.

Microwave computers

I recently heard through a colleague and fellow Kaypro user that research on the radiation emission of microcomputer screens has indicated that a typical user receives the equivalent of dozens of chest X-rays each year. This is an alarming number, given that doctors recommend having no more than one chest X-ray per year.

This colleague also had heard that, because of their awareness of this issue, Japanese computer manufacturers install protective shields on their screens.

This would seem to be an important issue for *PROFILES* to address. In particular, the public should be informed about the findings of reputable and independent research on screen radiation. Also, what are the most effective and least expensive modifications users can obtain to reduce the hazard?

Douglas D. Perkins
Philadelphia, Pennsylvania

The X-ray emissions of all CRTs are tightly controlled by federal regulations. The emissions in all frequency bands from a CRT are proportional to the applied cathode voltage. Monochrome (green)

CRTs used in Kaypro computers are specified to emit .0005 R/H (Roentgens per hour) maximum. In actual use emissions are much lower (.00012 R/H). This is because the maximum emission levels are measured at a much higher cathode voltage than a Kaypro uses.

We say emissions in actual use are closer to .00012 R/H because emissions this low are very difficult to measure. Background radiation in many parts of the country is higher than this and masks the emissions of the CRT. For example, background radiation in both Denver, Colorado, and in Washington, D. C., is normally above this level.

Color CRTs emit more X-rays than monochrome CRTs because higher voltages are used. But even these are significantly less than the emissions from a color television.

This subject of dangerous radiation from CRTs comes up every couple of years. Each time, it turns out that the procedures used in the so-called research are questionable. The bottom line is that spending money on modifications such as leaded glass shields is a waste of money.

Eyestrain caused by improper lighting conditions in the work area is a more pertinent problem to be concerned about. Glare and reflections on the CRT are a more serious threat than X-ray emissions ever were or will be.

Technical frustration

In reference to your Technical Forum of June 1985: Man, have you hit on a sore point!

Where in the bloody-blue-blazes does Kaypro indicate just where "Ports is Ports?" I have a Kaypro 2'84. I would really like to do some assembly language programming

on this machine. Without the correct port addresses, I'm lost.

How can I possibly get the information you take for granted in this column?

Please beef up this kind of hacking information in your future columns. You'll be doing the readership and the circulation director a tremendous favor.

William Mohr
Benton Harbor, Michigan

The Technical Forum column of November 1984 contained a listing of port addresses for Kaypro computers. Another excellent source of technical information is Micro Cornucopia, one of our regular advertisers. Their schematic package, with its theory of operation, is an excellent value. If you're really into assembly language and Kaypros, I would recommend subscribing to Micro Cornucopia as well as PROFILES.

In addition to port addresses you'll need the data sheets for individual chips. Your best bet here is to get the "data books" put together by the chip manufacturers. These can usually be found at electronic parts stores or ham radio stores. For some reason, not many computer dealers handle these books unless they cater to the "hacker" trade.

I agree that more technical information should be made available in the user guides. I hope that this situation can be corrected in the future.

BASIC code conversion

I have been having a good deal of trouble converting some programs written in other dialects of BASIC into code that runs on my Kaypro. The lines that are giving me the most trouble have either a "LO-CATE" or "PRINT@" command

Get the Proportional Printing Program which **REALLY WORKS!**

PropStar gives type-set quality true proportional spaced printing from unmodified NewWord and WordStar document files. Prints on most daisy-wheel printers with p.s. type-wheels, including Diablo, Qume, NEC, Brother, C-Itoh, Juki, Silver-Reed.

PropStar is a stand-alone program, not a patch to your w.p. program, gives higher quality print than modified WordStar. **PropStar** follows the rules for typesetting, it maintains correct spacing between letters, and never crowds text in short lines or lines with many caps. **PropStar** increases spacing between letters when in "bold" text to avoid run-together letters. **PropStar** doesn't move text from one line to another, you get what you see on your screen.

PropStar supports most WordStar and NewWord print features. New version 2 adds automatic page breaks and many other features not available in version 1.

CP/M-80 version available on 8" and more than 40 5.25" formats including Kaypro and Morrow formats. MS-DOS version comes on 5.25" PC media. Only \$ 49.95, Visa & M/C accepted, or send check with order and we pay postage. **PropStar** is fully pre-configured so please specify your computer and printer models.

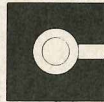

CIVIL
COMPUTING
CORPORATION

2111 Research Drive, Suite 1
Livermore, California 94550

(415) 455-8086



CHECKS & BALANCES \$49.95

Incredibly Low Price
We Will Beat Any Price In This Magazine
For This Program — Money Back Guarantee
(Offer Exp. Oct. 31)

Home Inventory (+) \$39.95

Home Inventory (+) is a complete personal inventory storage & retrieval system. All math is done within the program. Printouts are clear & complete & give you designated sub-totals & totals. Allows for unlimited data files. Change data disks while the program is running. Multiple searches. Perfect for insurance needs, home or office.

PRO-Mail \$29.95

PRO-Mail prints out your lists or label in any order you designate. (8 sorts provided.) Duplicate removal function, change disks inside the program, automatic backup feature. Allows for two comments fields, multiple label printing, Search any field, other features included.

Recipe Index \$29.95

Recipe Index will put any recipe in any cookbook at your fingertips. Printout alphabetical by category, ingredient or in any keyword order (dessert, low-cal etc.) Automatic backup, change data disk while running program, other features included.

Trivia Supreme — NEW — \$24.95

A computer trivia game with over 2400 questions. Fun for all.

Super "C" — NEW — \$19.95

Does 24 popular conversions. Included are metric, temperature, microwave time conversions, & others.

★ ★ ★ SPECIAL ★ ★ ★

Buy any two programs and get Super "C" for FREE

Send for catalogue



SPECIFY COMPUTER MODEL

Add \$3.00 S & H, \$4.00 UPS 2nd Day Air, outside U.S. \$7.00

★ **HURD COMPUTER SYSTEMS** ★

6330 Lincoln Avenue • Cypress, CA 90630 • (714) 220-2729



ALPINE DATA

THE KAYPRO SOFTWARE INNOVATORS

- **REAL/PACK** For Appraisers, Real Estate Sales or Banking Institutions. Maintains a data base of subject and comparable properties for sales analysis, property listings & profitable completion of FNMA form 1004. Menu driven, full support. CPM/MSDOS **\$495**
- **OIL/PACK** Inventory, Invoicing and Accounts management for the small to mid sized Oil Marketeer. Tracks inventory purchases or transfers, prints A/R statements, computes fuel taxes automatically plus other report features. Formats available for Petroleum Distributors or LP Gas Distributors. CPM/MSDOS **\$1395**
- **UTILITY BILLING** Account management, billing, statements for any flat or variable rate billed business; storage rentals, trash haulers, truck routing, municipalities, water, sewage, gas, broad application, customizing available. CPM/MSDOS **\$1395**
- **TAX/PACK** For Tax Practitioner. Completes IRS 1040 form and 24 most used schedules and forms. Depreciation, Mortgage schedules, client billing and client worksheet. Batch printing-client proforma available. CPM/MSDOS **\$395**
- **RETAIL BILLING & INVENTORY** Available soon.

635 MAIN STREET MONTROSE, COLORADO 81401 (303) 249-1400



1-800-336-1414 ORDERS ONLY



FINANCIAL FILER CHECK/LEDGER \$69.95 Track expenses for budgets and taxes and balance your checkbooks. Menu driven, fast, powerful, and a pleasure to use.

- Up to 99 Expense Categories, 9 Bank Accounts/Credit Cards per file, 25 Cash Codes.
- Full range of editing features to make entries fast and easy.
- Check Register, Clear Checks, Running Balance/Bank Balance, Category totals, much more.
- Unique Search program finds and totals items you've never had time to look at before.
- Built in tape printing calculator.

PROMAILER \$69.95 A mailing system easy enough for a Christmas Card list, and powerful enough for a small business.

- Unlimited searching choices in any part of entry with no set up required.
- Sorts in order alphabetically, by zip, state, address.
- Prints 1 or 3 across labels, lists, and envelopes.

PROMAIL III 99.95 The built in Type II program and Form Letter function combine to make this a mailing system you won't outgrow.

- Print any size label or envelope as well as letter headings, form letters, etc.
- Fill in pre-printed forms with ease.

TYPE-WRITE \$44.50 The solution for the typing jobs "word processors" can't handle and with a built in tape printing calculator.

- Forms, letters, envelopes, are easy with Type-Write's full range of editing functions.
- Line justify, word wrap, line center, flush right, adjustable margins, printer codes.

TYPE-WRITE II \$59.95 The addition of a Form Letter Function makes this Type program handle the toughest jobs. Print letter headings, form letters, even fill out pre-printed forms automatically. A great time saver.

PRINTER CHARACTER SET \$44.50 Ten new print styles for your dot matrix printer without giving up the features you're used to. Very easy to use.

- Italics, Script, Small, Correspondence, Brush, Roman and Gothic variations.
- Menu selections include style, pitch, line spacing, with the push of a key.
- Russian, Greek, Hebrew and Scientific available (\$20.00) each.*

CHARACTER DESIGN KIT \$59.95 Design your own printer characters on your computer screen. Perfect for special print styles, foreign languages, graphic characters, etc.

- Includes Roman, Gothic and graphics sets.*
- *Okidata (R) 92, 93, 2410, [Gemini 10X, 15X, Delta, Radix (R)], Epson, FX-80, FX-100.
Please specify printer brand and model.

Kaypro (R) / PC compatibles. Add \$2.00 shipping.

Indiana orders add 5% tax. MC/VISA Program updates at minimal cost.

Call or write for more information (no collect calls).

WOODSMITH SOFTWARE

Rt. 3, Box 550A — Nashville, IN 47448 — (812)988-2137

TRADEMARKS—Okidata (Okidata Corp.) Star Micronics, Inc. Kaypro (Kaypro Corp.)

Q & A

somewhere in the statement.

These commands are used heavily in game programs. Can you help me out?

Rob Miller
Union, Oregon

The commands you refer to, "LOCATE" in IBM BASICA and "PRINT@" in Radio Shack BASIC, are for cursor positioning. These commands exist to make cursor positioning easy in a BASIC dialect designed for a specific computer. The BASIC that comes with Kaypro computers is Microsoft BASIC-80, a generic BASIC with no such built-in commands.

You can do the same thing in BASIC-80 by sending Kaypros' cursor positioning string, ESC = ROW COL, to the screen in a print statement. ROW and COL need to have an offset of 32 added to them before being sent to the screen. The easiest way is to assign the row and column numbers you want to move to in the variables ROW and COL. Then insert the following statement: PRINT CHR\$(27) + CHR\$(61) + CHR\$(ROW+32) + CHR\$(COL+32).

The PRINT@ statement in TANDY BASIC is a little harder to convert into row and column numbers. This is because this BASIC dialect looks at the screen as a sequential list of positions. After column 65 on each row the next number simply wraps to column 1 of the next line. (PRINT@ 1 means row 1 column 1 and PRINT@ 66 is row 2 column 1.) There may be some deviation from this formula, depending on just which Radio Shack model the code was intended for. A little experimentation with the code may be needed, but the basic idea is correct.

Cooked Kaypro

I have a Kaypro 10 that became overheated because I let 1/4 inch of dirt accumulate on the fan. Now it works for about an hour and a half and then crashes. In two hours it cools off enough to go for another hour and a half.

I believe the problem is heat damage, but no one has been able to fix it. It was in the shop for a full month with no solution. Is there a troubleshooting book available? Self-help seems to be the only solution.

Nick Borst
Warrenton, Virginia

I'm sure you've learned a lesson about cleaning the fan filter.

Given the conditions that you describe, there's a good chance of massive heat damage in your machine. This kind of damage could affect more than one component. The most heat-sensitive one in a Kaypro 10 is the hard-disk controller board. It's difficult to accept that your dealer could not fix the damage. I'd start patronizing another dealer.

Kaypro sells its dealers repair kits that allow them to replace every single component in the computer. With this parts kit, a dealer can keep replacing modules until the computer works.

The only troubleshooting book devoted to Kaypro that I know of is the Dealers Reference Manual from Kaypro. Many dealers sell them to customers looking for technical information about their computers. I'd sincerely advise you to try another dealer instead of doing it yourself. Without technical training, you could do more damage than good, and, more importantly, you could get hurt. □

NEW

BANNERS & SIGNS

8" or 11" LETTERS



Randy HAPPY BIRTHDAY!

50% OFF SALE

HI MOM

NOW YOU CAN GET YOUR MESSAGE ACROSS IN BANNER STYLE LETTERING.

The Banner Program prints 8" or 11" upper and/or lower case characters in regular and inverse. Letters are composed of any characters you choose. This easy to use program works on any CP/M or MS-DOS system with 64K memory and any printer. The Banner Program is run like any other .COM or .EXE file and includes A to Z instructions. Whether you are operating a business or having fun at home, this program has many applications — BANNER.

ORDERING INFORMATION To order the Banner Program send \$18.95 plus \$2.00 shipping (California residents add 6% sales tax.) to Custom Program House, P.O. Box 4710, Berkeley, CA 94704. Please specify format and quantity.

PC/MS-DOS _____, 8" CP/M _____, 5 1/4" CP/M _____

ONLY 1895
plus shipping.

VISA & MASTERCARD Accepted.

CPH CUSTOMPROGRAMHOUSE
P.O. Box 4710, Berkeley, CA 94704, (415) 652-8222/24 Hr. Service



Can You Use More Space?

Get ProMaster!



Available in clear or bronze
1-800-223-5369 Ext. 221

only **\$39.95**
add \$5.00 for bronze

Free shipping on orders before 9/21/85
Visa, MC or C.O.D. welcome
Az. residents add 6% sales tax

Another Arizona Plastics Masterpiece

A handsome acrylic stand that . . .

- ★ Provides convenient storage
- ★ Frees up valuable desk space
- ★ Enhances your work environment
- ★ Reduces eye and back strain
- ★ Fits most Kaypros 1, 2, 4, 10, & 16
- ★ Supports your Kaypro solidly

Arizona Plastics



Computer Products Division
790 South Park Avenue
Tucson, Az. 85719

Dealer inquiries welcome



Editor's Notes

PROFILES and bandwagons

by Tom Foote

Picture this: Excited buyers tearing into the boxes of their new IBM-compatible Kaypros (16, 16-2, 2000, 286i, or even other models yet to come). There it is: the latest issue of "*PROFILES*, The Magazine for Kaypro Users."

"Super," they think, "a magazine written just for me!"

Super—until they start reading.

Sure, we've covered more of the IBM world than most might think: "CP/M vs. MS-DOS", December/January 1985; MS-DOS upgrade in "Q & A", April 1985; "WordStar Deluxe", July/August 1985; and separate stories on the Kaypro 16, 2000, and 286i in our 1985 February, May, June, and July issues. But, so far, buyers of Kaypro 16-bit machines do have reason to ask: "Will this predominantly CP/M magazine offer *me* enough to justify paying for it?"

A fate worse than "The New Coke?"

Oh, please, you say, let the already-privileged IBMers savor the wealth of publications that speak to them exclusively. (Anyone notice how some ads in even *Byte* and *InfoWorld* no longer bother to specify operating systems? Is this a subliminal directive to get on the PC/MS-DOS bandwagon before it rolls over you?)

I can hear you now, exclaiming: "Don't you dare IBM-ize *PROFILES*!" You are that last great vestige of microcomputing's beginnings. You're all we CP/Mers have got." (We've received other urgings just as strong.)

What the numbers say

I share your passion to hype the case for CP/M, and, of course, for *PROFILES*. But I thought we'd all be better off arguing from objective estimates rather than emotion—estimates, however rough, that hint at the numbers of potential readers using either system.

Since *PROFILES* is the largest predominantly CP/M magazine still alive (95,000 copies printed each month), I wondered just how big the whole CP/M market is—irrespective of machine type. InfoCorp estimates that, as of last December 31st (1984), CP/M machines comprised 37 percent of the installed base of CP/M, IBM, and IBM-compatibles. That is, they estimate 1.7 million CP/M machines sold versus 2.85 million IBM and IBM-compatibles. (Yes, the data are old. Moreover, the CP/M count excludes the number of CP/M Apples—widely thought to be the largest share of the CP/M pie. But it's the best that InfoCorp and I could do at press time.)

This huge CP/M installed base represents a tempting market, to be sure, but this is the magazine for *Kaypro* users.

So what are the corresponding Kaypro proportions? Roughly speaking, sales through June 30,

1985, show that CP/M machines still comprise the vast majority of all Kaypros sold. However, the IBM-compatible proportion is growing rapidly.

PROFILES' plans

We want to continue serving our large majority of CP/M users. But to ignore the growing proportion of Kaypro MS-DOS users makes packing this magazine with Kaypro's newest machines a little silly.

What we *can* do is cover more MS-DOS, but in ways that will genuinely benefit and please the CP/M users too.

Our plans: The January 1986 issue will mark the launching of a new *PROFILES*. It will appear twelve, not ten, times a year. It will offer a different look, a column on MS-DOS, and generally more appeal to MS-DOS Kaypro users. But, completely unlike those so-called "exclusive" magazines—it will continue to offer much productivity-boosting CP/M material, while making MS-DOS articles appeal to CP/M users too.

How to do the latter? By having those experienced in both CP/M and MS-DOS write the MS-DOS articles, and by stressing just how MS-DOS hardware, software, and technique compare to known entities on the CP/M side.

We already feel challenged by serving broad ranges of age, interest, and expertise—now add two different operating systems?

Relax. We're excited about the new challenges. And we think you'll be pleased with the results. □

Introducing

PROFILES

The Magazine For Kaypro Users

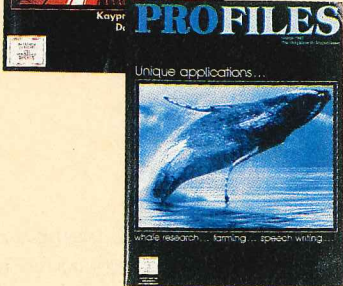
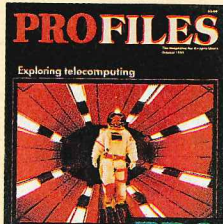

If you own a Kaypro, six issues of *PROFILES* won't cost you a penny.

There's Gold in Those Programs

By George Skelton

As the computer age grows, so does the number of programs available. Some are excellent, some are mediocre, and some are downright terrible. But one thing is true: there is a gold mine of programs out there waiting to be discovered. In this issue, we explore some of the best programs available for the Kaypro. From word processing to spreadsheets, we have it all. So if you're looking for a new program to try, look no further than this issue.



If you've purchased a Kaypro computer, the cost of a six-issue *PROFILES* subscription was included in the purchase price. If you sent in your warranty card, you should be on the mailing list. If you haven't received an issue in the mail, please fill out the form below and send it in. We must have accurate serial numbers and zip codes for subscriptions to go through, so be thorough. Please allow 10-12 weeks for delivery. Note: the

Speaking Through Your Kaypro

How to use your computer to plan and write a speech

By Linda Pyle

Writing a speech can be a daunting task. But with the help of your Kaypro, it can be a breeze. This issue features a special program that allows you to plan and write your speech using your computer. It's a great tool for anyone who needs to give a speech, whether it's for work or school. So if you're looking for a way to make writing a speech easier, look no further than this issue.



introductory subscription begins with the first issue you receive in the mail and has no relationship to the complimentary issue packed in your machine.

If you don't have the luck to own a Kaypro, you can still subscribe (use the lower form). Or you can pick up a copy at any authorized Kaypro dealer. Call Toll Free Nationwide 1-800-4KAYPRO / In Calif. 1-800-9KAYPRO for the dealer nearest you.

**Yes,
I own
a
Kaypro.**

Please Begin My Introductory Six-issue Subscription.

Name: _____ (LAST) _____ (FIRST) _____ (M.I.)

Address: _____
*(U.S. Only)

City: _____

State: _____ Zip: _____

Kaypro model: _____

Date purchased: _____

Serial number: _____ Check here if used
(No introductory subscriptions without serial number)

Send to: *PROFILES* Subscriptions, P.O. Box 2889, Del Mar, CA 92014.

Please allow 10-12 weeks for delivery.

*Owners outside of U.S.A. should consult their Kaypro dealers, or write to: Kaypro International, P.O. Box N, Del Mar, CA 92014. Additional postage rates will apply.

RENEWALS ONLY

Please attach current mailing label.

SUBSCRIPTION RENEWAL

I enclosed \$21 for one-year subscription (10 issues) plus 11th issue bonus. SAVE \$4 OFF REGULAR RATE.

Please bill me \$21 for 10 issues.

4BBZZ

**No,
I don't
own a
Kaypro.**

I'd like to receive ten issues of *PROFILES*, and I've enclosed a \$25.00 check or money order made payable to Kaypro Corporation.
(No cash, please)

Name: _____ (LAST) _____ (FIRST) _____ (M.I.)

Address: _____

City: _____

State: _____ Zip: _____

*Subscribers outside of U.S.A. should write to: Kaypro International, P.O. Box N, Del Mar, CA 92014.

Send to: *PROFILES* Subscriptions, P.O. Box 2889, Del Mar, CA 92014.

Please allow 10-12 weeks for delivery.

4BBZZ

Life at 300 Baud

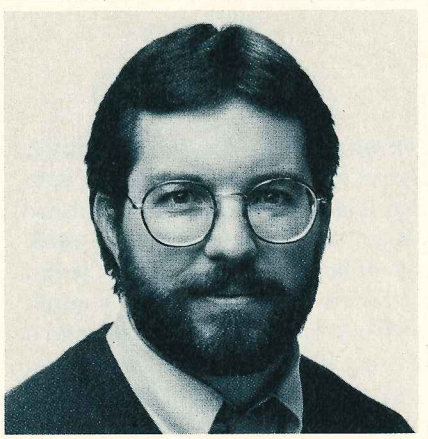

by Brock Meeks

Education in the Information Age is a quantum leap from the days of the one-room schoolhouse. Interactive videotex, modems and online databases are the high-tech counterparts of chalkboards, lecture halls and libraries.

Terms like "electronic classroom," "online education," and "telelearning" put new meaning in the Madison Avenue hype phrase "back to school." Buzzwords aside, it all boils down to getting an education without setting foot inside a classroom.

Online universities

Telelearning Systems of San Francisco is now in its third year of providing an online education. Founded by Ron Gordon (former chief executive officer of Atari), Telelearning Systems offers hundreds of online courses via its "Electronic University."

Connecting with the Electronic University is easy. All you need is a modem (300/1200 baud) and the communications software provided by Telelearning when you enroll. (Enrollment is handled through an 800 number voice line—see listing at end of this article). Courses cover subjects from computer skills to parenting, accounting to law.

Currently 200 colleges and uni-

The electronic schoolhouse

versities across the nation participate in the network that forms the Electronic University.

For example, you have a choice of three different Master of Business Administration programs offered by City University of Bellevue, Washington. Edison State College in New Jersey offers four undergraduate degrees. These degree programs, and more than 170 individual courses, are all part of the Electronic University's extensive curriculum.

Each school develops its own courses and forwards them to Telelearning, which incorporates them into the general program.

Gordon stresses that online courses are developed solely by the originating institution, and not by Telelearning. The credits a student receives and that an employer or other institution will evaluate will not be credits from Telelearning, but from the school that originally developed the course. And on students' transcripts, there's no difference between courses taken on campus or through the Electronic University.

Costs range from \$90 to \$150 per class, depending on the course you enroll in.

All the Electronic University's courses meet or exceed standard College Level Examination Program (CLEP) levels. According to Telelearning, you can transfer your credits to more than 1,700 schools that currently accept CLEP level courses.

All "class work" is done via modem. When you finish an assignment, you upload it to the

Telelearning network. A professor then grades and comments on your work. If at any time an assignment has you stumped, you can arrange to "talk" with your professor via an online real-time conference.

Executive education

The Western Behavioral Sciences Institute (WBSI) of La Jolla, California, offers online courses designed to help executives and government officials improve their management and communications skills. A 27-year-old "think tank" researching human communication, governmental policy, and education, WBSI developed its online educational program to "alert today's decision makers to the new requirements of leadership," says its president Dr. Richard Farsen.

The online structure of WBSI affords people in leadership the opportunity to learn from each other, according to Farsen.

Participants go through a two-year program consisting of four modules. Each module lasts six months, and each one of those six months is devoted to a separate course. Subjects include "The Private Sector and The State," "Technological Evolution and Its Effect on Society," "Management of Scarcity and Abundance," "International Economics and Trade" (a cross-cultural economics study program), and "Global Access and Interdependence."

The advantage of WBSI's program is that it doesn't take students away from the work environment (as do some of the high-powered management schools, such as Har-

vard's, where participants must leave their jobs for a long time).

Using computer conferencing, participants discuss areas of concern, hold debates, and critique each other's papers (and hash out their frustration with the medium).

Participants include college presidents, corporate CEOs, and national and foreign government officials.

There is a small catch: the price tag. A two-year stint online with WBSI costs \$25,000 (yes, that's a comma there, not a decimal point).

Current enrollment consists of participants from Westinghouse, TRW, the Central Intelligence Agency, Hewlett Packard, DEC, AT&T, Phillip Morris, Chase Manhattan Bank, the Government Accounting Office, Pacific Gas and Electric, Southern California Gas, Textronics, Saleina A. B. (the largest shipping firm in Sweden) and Marathon Oil (of Caracas, Venezuela)—to name a few.

A recent review of the nation's top business management programs by the *Harvard Business Review* placed WBSI's program in the top five and suggested that other management programs emulate WBSI's form and content.

International electronic learning

The Intercultural Network is an experimental research program designed to promote a better understanding of different cultures among high school students.

The network is the collective effort of six professors from the University of California at San Diego, Hebrew University in Israel and Tokyo University in Japan.

Dr. Margaret Riel, one of the developers at UCSD, says the intention of the network is to "give the kids involved a global perspective of the world."

Using the electronic mail and computer conferencing functions of a commercial information utility, students in Japan, Israel, Mexico and the United States take part in an online electronic network that draws them into each other's lives.

One way of helping students develop this global perspective is

by a "news analysis" project.

"We had each of the different sites collect headlines from their major newspapers and compare them," said Riel. "This way the kids gained an understanding of how the media in different cultures reports the news. What's important in San Diego hardly makes a difference in Israel—which is some-

tion Corporation (NEC) of Newport Beach, California, has offered in-home independent study courses. NEC hopes its new online National Education Network will encourage students to study at home using microcomputers.

NEC currently offers 60 independent study courses, and early this fall it will announce an agree-

200 colleges and universities across the nation form the Electronic University.

thing they hadn't been aware of before."

Since the medium allows multiple input, all participants can see and comment on what the others observe. This stimulates further conversation and encourages exploration of different cultures.

In-home goes online

For 30 years the National Educa-

tion Corporation giant AT&T that will allow NEC to take advantage of expanded videotex technology. Enrollment is not limited in any way and is accomplished with a simple phone call.

NEC will supply communications software to support any modem type. Online students will be able to communicate with NEC's online instructors and take tests at

STOCKCHIP



OWN STOCK? PLAN TO OWN STOCK? OWN AN IRA?



- ✓ Record all transactions
- ✓ Analyze performance
- ✓ Prepare complicated tax form entries even with difficult utility shares
- ✓ Project long/short term gain and loss
- ✓ Compute hypothetical buys and sells
- ✓ Maintain complete records
- ✓ Check bottom line profit and loss in a matter of seconds
- ✓ Generates 8 different reports
- ✓ Accepts up to 300 stocks
- ✓ Plus many other features
- ✓ Available on PC/MS-DOS and CP/M-80

For those who now own and for those who plan to own STOCK INVESTMENTS... Stanton Software offers a complete, comprehensive, and most of all... EASY TO USE, Stock Portfolio Management Program.

Quality Assured, thorough documentation, menu-driven
Reasonably priced at \$149 with potential tax benefits (add \$3.00 shipping).
TO ORDER Call 314-576-7482 or write to:
STANTON SOFTWARE • Box 28762 • St. Louis, Mo. 63146

MASTER CARD*VISA*MONEY ORDER*SATISFACTION GUARANTEED



αβγδεζηθικλμνξοπρστυφχψωΓΔΘΛΞΠΕΤΦΨΩΘ◊◻▲≤≥∇°†‡Γ]

CHARTECH turns WORDSTAR™ into a great TECHNICAL WORD PROCESSOR

$$\Lambda = \sum [\Gamma_{\alpha\beta} + \Omega_{\gamma\nu}] \quad \tau = \int_a^b dx \theta_{nn'} \phi(x) \frac{\partial \Psi}{\partial x}$$

CHARTECH software (\$95 for Kaypros™) allows you to print 94 special characters on most dot-matrix printers and some daisys, design your own characters, and fully control your **PRINTER**. With our ROM (\$40), special characters are displayed on screen of Kaypros with graphics. This entire ad was created with CHARTECH. CHARTECH is used at top government and private agencies and universities.

Order Now! We Accept Visa and Master Charge! Call: **(503) 484-0520**. Ask about our new **FOREIGN LANGUAGE** products. CHARTECH runs on most systems that run WordStar.

TECHWARE

P. O. Box 10545, Eugene, OR 97440

ΔΘΩΓΔΘΛΞΠΕΤΦΨΩΧ ς √ ≤ ≥ ∇ ° † ‡ Γ] [] → ∇ √ / \ ½ - ∞ ± 4 » « ≡ ≈

300 BAUD

home with their computers.

NEC offers 12 two-year associate degree programs. Most of these are in vocational/technical areas such as auto mechanics and basic electronics. Although NEC is accredited in California, transfer of NEC credits is at the discretion of the receiving institution.

All NEC courses are developed by in-house staff, and fees are \$500 to \$1,200 per course. The curriculum is extensive—you can study everything from fashion merchandising to civil engineering.

University to the world

"We want to be a university to the world," says Connected Education's director Paul Levinson. "Our philosophy is that education shouldn't be tied to a classroom or geographic region."

In conjunction with the New York-based New School of Social Research, Connect Ed is pushing the traditional views of education into a new perspective.

Connect Ed's first semester starts in September, and its curriculum is small. Levinson (who uses a Kaypro 10 to conduct his classes) explains the scarcity of courses. "We wanted to be sure we had a solid base of courses and a group of dependable online instructors. Once established, we plan to expand rapidly."

Courses offered this semester are "Teleworld," an analysis of the social impacts of new media; "Artificial Intelligence and Real Life," which asks questions such as "Is protein necessary for intelligence?"; plus "Propaganda: The Literary Science." All three courses are offered for credit through the New School of Social Research. Levinson says transfer of Connect Ed credits to other institutions is possible at the discretion of the receiving school.

There are definite plans to expand the curriculum for the next semester. Future subjects include "Telelaw," "Nuclear Peril" and "Science Fiction."

(continued on page 78)

Our latest software package

ModemMail

... the next generation in CP/M communications



Now you can set up your own bulletin board system, transfer files, and operate a store and forward mail network that spans the globe—all with one CP/M program **ModemMail.**

FEATURES

- The ModemMail Bulletin Board System
- The ModemMail Store and Forward Electronic Mail Network
- Automatic File Transfer ... including XMODEM
- Data Encryption
- Full Programmable, Unattended Operation
- Terminal Communications
- Switchable Modem Ports
- and a Comprehensive User's Manual, featuring a Step-By-Step tutorial for new users 249.00

ORDERS & INQUIRIES CALL 415 / 658-2881 MASTERCARD AND VISA ACCEPTED



INCORPORATED
VISION...INTEGRITY...SERVICE

166 SANTA CLARA AVENUE OAKLAND, CA 94610

Reach for the height of your craft...



As an idea craftsman, you use your mind like a skilled pair of hands. You take hold of concepts, then manipulate them to discover, refine, convey dynamic new thoughts.

Now, the tool that can strengthen your creative grasp is well within your reach.

KAMAS™ a revolutionary outline processor from KAMASOFT*, supports your thinking process and keeps you in touch with your ideas. That's because KAMAS is designed to work the way your mind works—naturally.

Begin by brainstorming. KAMAS enables you to jot down ideas quickly, as you think of them. If you want to elaborate, you can add text with full screen editing. Then develop your ideas using a familiar outline format. Change the structure as easily as you change your mind. Move an idea and all attached text moves with it.

KAMAS puts full control at your fingertips. You can keep track of your main line of thought by collapsing the details from view. Then, expand the outline to develop the specifics when you need to. By collapsing and expanding portions of the outline, you can maintain an overview and literally see how your ideas fit together.

And KAMAS is fast. Your ideas remain at your fingertips. KAMAS can locate and retrieve by keyword—even a misspelled one—in less than a second per topic file.

Use as much of the power as you feel comfortable with. KAMAS is menu-driven with over 100 on-line help screens. But you can also open the hood to find a high performance programming environment with the additional horsepower you may need to get the job done. An active user community and the KAMAS Report newsletter keep you in touch with the latest KAMAS applications.

Achieve a commanding vantage point...

KAMAS, Z80, & CP/M are trademarks of KAMASOFT*, Zilog, & Digital Research respectively. * formerly Compusophic Systems.

Get your hands on KAMAS now. Send \$147 plus \$4 for S/H. Or call (503) 649-3765 for VISA or MasterCard orders. KAMAS is available for many Z80, CP/M computers. Ask about your system.

KAMASOFT*
2525 SW 224th Ave., Dept. 101
Aloha, OR 97006

...with **KAMAS**™

CHUCK ATKINSON makes money and inventory management easy with *new* **QUICK CHECK PLUS**® and **QUICK REGISTER**®



...the greatest programs on earth for small businesses and professional people!

"It is fabulous... the best software I've ever had."

Dr. George Yama,
Pulaski, Virginia

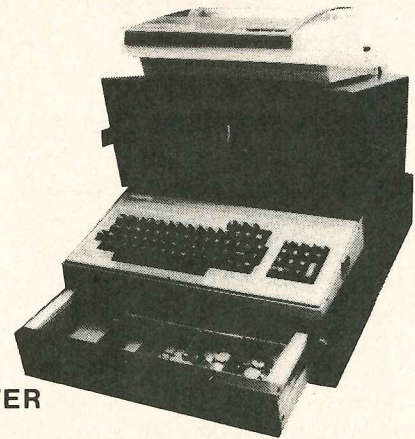

New

QUICK CHECK PLUS (QC+)

This program makes money management easy, even for those without accounting or computer experience. It includes book-keeping, checking, accounts payable and accounts receivable. It will show income, expenses, balance, and pay records at the touch of a button. The program loads and runs in a flash.

QUICK CHECK PLUS, \$195.

QUICK REGISTER including RETAIL INVENTORY PROGRAM (RIP)

QUICK REGISTER (POINT OF SALE) turns your computer into a very special cash register. Enter the quantity and item number of each sale, and the computer records the sale, prints the invoice, and adjusts the inventory! RIP lists the inventory several ways instantly. It takes care of inventory control, purchasing, labels, and keeps track of vendors.

QUICK REGISTER with RIP, \$395.

For the name of your nearest dealer, write or call:

CHUCK ATKINSON PROGRAMS

Route 5, Box 277-C • Benbrook, Texas 76126 • (817) 249-0166

Flea Market

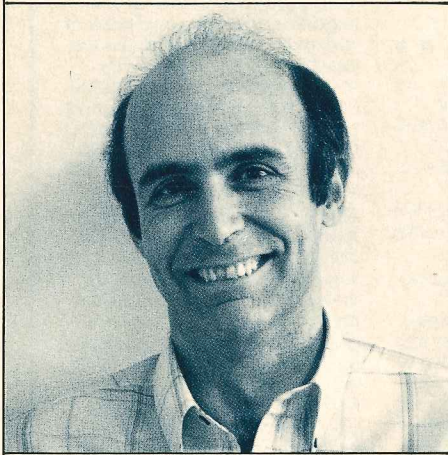

by Ted Silveira

Around the beginning of the year, things looked bleak in the CP/M public domain. ZCPR3 and MEX were still growing, but major bulletin boards were giving more space to MS-DOS, and it seemed that no new CP/M programs were coming out. Then around March came signs of life—three new public domain programs of special interest to Kaypro users: VDO25, TOUR20, and DDRAW (a graphics package I'll cover in a future column).

VDO25

VDO25 is a WordStar-like text editor whose virtues are speed and small size. It's fast; when you jump from the beginning to the end of a file, even a 50K one, you're there *immediately*, a real treat for people used to WordStar's constant disk grinding. And it's small, only 7K—quite an achievement considering the features crammed into that space. (WordStar takes up around 80K in three files.) Because VDO25 is so small, it loads quickly and fits easily on disks where there's no room for WordStar.

Versions of VDO have been available for the Osborne computer, with its special video, for a long time, but they wouldn't run on Kaypros or most other computers. Fortunately, software author James Whorton has now created VDO25, so Kaypro

CP/M public domain can still fog a mirror

owners can use this nifty little program, too.

- *WordStar-style Commands.* VDO25 is a full-screen editor and can handle a text file up to 50K long. (The entire text file must fit in memory along with VDO25, which can't buffer long files on a disk as WordStar can.) It has limited formatting and printing and follows WordStar commands, behaving like WordStar in the non-document mode: no word-wrap and no soft carriage returns or other soft formatting.

VDO25 has most WordStar editing commands. For movement, it uses the WordStar "cursor diamond" keys, except for ^Z and ^W. It also has all the WordStar delete commands and can operate in either insert or overwrite mode.

- *Quick Commands.* From the WordStar ^Q menu, VDO25 has ^QB and ^QK to move to the beginning or end of a block, and ^QR and ^QC to move to the beginning or end of the file. It also has the find (^QF) and find/replace (^QA) functions, which can search backward or forward and can ignore case or not. VDO25 doesn't have the ^QS, ^QD, ^QE, or ^QX commands, but it has one new command, ^QT, for changing tab stops to 2, 4, 8, or 16 columns.

- *Block Commands.* From the WordStar ^K menu, VDO25 uses ^KB and ^KK to set the block markers, as well as the usual WordStar commands to copy, delete, write, or read. ^KS and ^KX save files, and ^KQ abandons. ^KZ will erase the current file from memory.

VDO25 also has WordStar's ^KF,

to turn the disk directory display on and off, and ^KL to log in a new disk. Because VDO25 keeps your current file entirely in memory, you can change data disks in the middle of editing a file, use ^KL to log in the new disk, and then save your file to the new disk, without provoking a disk error. Just try that with WordStar.

- *Limited Print Commands.* VDO25's print command is very limited. When you hit ^KP, VDO25 asks for "printer set-up codes," and you then enter whatever is needed to initialize your printer. When you press <RETURN>, VDO25 sends the current file to the CP/M list device.

VDO25 has a ^J help menu, which lets you review the program's other commands. From this menu, you can also set the help level to novice (full menus), normal (partial menus), or expert (no menus).

An earlier version of VDO, called VDO23 or VDO-KP, would lose characters in certain situations because it had no type-ahead buffer. In VDO25, that problem has been solved by adding a 128-character type-ahead buffer, similar to WordStar's.

To install VDO25, you use the accompanying program VINST11, which adapts VDO25 to either old or new Kaypros, as well as to most other popular terminals. The process is simple and fast.

- *Some Drawbacks of VDO25.* VDO25 has a couple of shortcomings. It does not visibly mark blocks, not even with and <K>. That can lead to annoying errors, since you never know if

you've marked a block correctly until you try to do something with it. Also, the ^A (word-left) command moves to the end of the previous word rather than to the beginning, and the ^KP print command freezes up if the printer's not turned on. (I miss having the ^Z and ^W commands, too.)

• *What's VDO25 Good For?*

VDO25 is excellent for writing programs and various kinds of command files, such as SUBMIT files and dBASE II .CMD files. I also use it for making notes, doing entries in a free-form database, knocking out messages for uploading to bulletin boards, and even writing quick letters, ones so short it's not worth switching disks to fire up WordStar. I keep finding new uses for it because it's always handy.

TOUR20

While VDO25 is a new version of something familiar, TOUR20 is something new. Its author, Ed Taychert, calls it a "document hierarchy editor," but most people call it an "outline processor."

• *A Tool for Ideas.* In brief, TOUR20 is a tool for handling ideas rather than for writing text. You jot down ideas in one-line headings, shuffle the headings around and arrange them hierarchically, with indentations:

0. Contents

1. What are the TOUR20 commands?
 - 1.1 For adding new headings
 - 1.1.1 APPEND
 - 1.1.2 INSERT
 - 1.2 For moving around
 - 1.2.1 UP and DOWN
 - 1.2.2 NEXT and BACK
 - 1.2.3 <INDEX>
 - 1.2.4 TOP
 - 1.3 For editing outlines
 - 1.3.1 CUT and PASTE
 - 1.3.2 CHANGE
 - 1.3.3 DELETE
 - 1.4 For viewing outlines
 - 1.4.1 VIEW and LIST
 - 1.4.2 SUBTREES
 - 1.4.3 ENTIRE
 - 1.5 For adding text
 - 1.5.1 INTRO
 - 1.5.2 SUMMARY
 - 1.6 For reading and writing files
 - 1.6.1 WRITE
 - 1.6.2 READ
 - 1.6.3 TYPE

FOR PERSONAL OR BUSINESS, IT'S. . .

Checks & Balances

THE BEST SINGLE-ENTRY ALTERNATIVE TO THOSE DOUBLE-ENTRY SYSTEMS!

Release 3.6 now available!

- ✓ Expanded 180-page manual with step by step instructions and tutorial on advanced features.
- ✓ Combined reports for multiple checkbooks.
- ✓ Detailed balance sheet and budget reports.
- ✓ Check writer handles nearly any check. Configuration for five checks from Deluxe Computer Forms included.
- ✓ Color available for PCs and the clones.
- ✓ Print labels, cards and address envelopes from the Rolodex.
- ✓ Keep logs of mileage and travel for tax records.
- ✓ FAST!!! Totally full screen operation—correct any entry just by typing over like your word processor. Compiled in assembler for speed. Not a Basic program like Home Accountant.
- ✓ Simple but powerful ENGLISH commands.
- ✓ GUARANTEED TO WORK ON YOUR SYSTEM OR YOUR MONEY BACK!
- ✓ Keeps a full year at a time—calendar or fiscal!
- ✓ Enter over 45 characters of memo/notes with each transaction. Dollars & Sense makes little sense with no memo!
- ✓ CP/M users—We still support you as well as PC-DOS and plain, vanilla MS-DOS (even ANSI standard, Apple CP/M and HP-125 and 150)!

**ONLY \$74.95 • 30-DAY GUARANTEE
NOT COPY PROTECTED**

SYSTEM REQUIREMENTS: CP/M—60K RAM, 80 x 24 screen. MS-DOS/PC-DOS—192K RAM. All require two floppies, RAM disk or hard disk. Specify SSDD or DSDD and computer type when ordering. \$3 P&H per order, COD \$4 extra. Outside USA, \$10 P&H per order, no COD. Visa or MC. Manual only, \$10 + P&H, refundable on purchase.

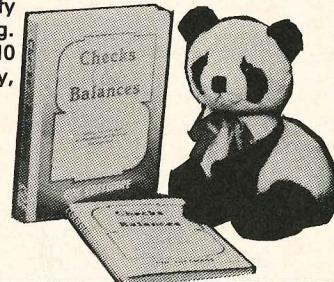

CDE SOFTWARE
948 Tularosa Drive
Los Angeles, CA 90026
(213) 661-2031

C&B IS AVAILABLE FROM THESE FINE PEOPLE

- | | | |
|--|--|---|
| <p>Valcon
1260 Westwood
Redwood City, CA 94061
(415) 369-2034
All formats—Area representative</p> | <p>Micrograph
144 Lakeside Drive
Peachtree, GA 30269
(404) 487-4617
All formats—Area representative</p> | <p>Advent Products, Inc.
3154-F East La Palma Avenue
Anaheim, CA 92806
(800) 821-8778 National
(800) 521-7182 California
All formats—Write for catalogue</p> |
| <p>J.A.C. Computer Services
806 West 209th Street
Torrance, CA 90502
(213) 328-4759
All formats—Area representative</p> | <p>Collin County MLS
1021 E. 15th
Plano, TX 75074
(214) 423-6211
All formats—Area representative</p> | <p>Country Computers
107 E. Virginia Avenue
Bonifay, FL 32425
(904) 547-4007
All Kaypro models, MS-DOS</p> |
| <p>Mycroft Distributors
P. O. Box 6045
Tallahassee, FL 32314
(904) 385-1141
All formats—Write for catalogue</p> | <p>Computer Network
888 East 3300 South
Salt Lake City, UT 84106
(801) 467-6000
Kaypro, MS-DOS</p> | |

REGIONAL DISTRIBUTORS

- | | |
|---|--|
| <p>Advent Products, Inc.
3154-F East La Palma Avenue
Anaheim, CA 92806
(800) 821-8778 National
(800) 521-7182 California</p> | <p>Mycroft Distributors
P. O. Box 6045
Tallahassee, FL 32314
(904) 385-1141</p> |
|---|--|

The basic unit in TOUR20 is the heading, a one-line (up to 134 characters) piece of text. These can be entered one at a time or in an automatic append mode that lets you dash off a string of headings and worry about exactly where they belong later. A heading can also be inserted into an existing outline at any point, causing all following headings to be renumbered.

• *Moving Through the Outline.* You move through the outline you've created by using UP and DOWN (which moves you up or down a level), NEXT and BACK (which moves you forward or backward one item, regardless of level), or <INDEX>. <INDEX> is the address of a particular heading, specified by its levels; in the outline above, the index 0.1.3.1 would take you to the heading called "CUT and PASTE."

• *Editing the Outline.* When it's

time to edit, you can CHANGE any heading (rewrite it, in other words). You can also DELETE any heading, which also deletes any subordinate headings so that deleting heading 1.5 above would also delete 1.5.1 and 1.5.2.

• *Viewing the Outline.* While you're working, you see only a small part of your outline—the current heading and its immediate sub-headings. If your current heading were 1.4 above, you'd see only sub-headings 1.4.1, 1.4.2, and 1.4.3.

TOUR20 has a strong personality; you could even say it has a theory about life.

The most important editing tools are CUT and PASTE. CUT removes a heading and stores it in a buffer; PASTE takes the heading out of the buffer and places it wherever you want. You can cut 20 headings before pasting, but you must remember that the last heading cut is the first heading pasted.

This "information hiding" is meant to help you concentrate on parts of your problem or project. You can use VIEW (or LIST) to see other parts of the outline, SUB-TREES to see everything below any particular heading (its sub-headings, their sub-sub-headings, and so on), and ENTIRE to see the complete outline.

• *Handling Text.* TOUR20 has only two commands for adding text to the outline. INTRO will place a block of text before a group of sub-headings, and SUMMARIZE will place one after; both are limited.

TOUR20 can also WRITE all or part of your outline into a disk file, READ another TOUR20 file into your current outline, and TYPE a text file on the screen without inserting it into the outline.

• *Using TOUR20.* So, what's TOUR20 like to use? It has a very strong personality; you could even say it has a theory about life. TOUR20 believes you'll do best if you work with a top-down, divide-and-conquer approach, gradually breaking your project or problem into smaller and smaller pieces. It also believes you should concentrate on one section at a time. You don't have to play along, but that's the way TOUR20 "wants" to work.

• *Working from the Top Down.* In practice, you'll probably use TOUR20 one of two ways. You can use the top-down method by stating your subject in a very general form ("What are the TOUR20 com-

(continued on page 79)

Introducing

GRAF 3.0

the complete BUSINESS and SCIENTIFIC printer graphics program

BUSINESS APPLICATIONS

- display floating point data directly from spreadsheets, data bases, and word processors (or the keyboard) in a wide variety of bar, pie, line, and scatter plots
- plot and group up to 6 different variables on a single graph, distinguished by up to 14 different "fill-in" patterns and 8 different point-plotting symbols
- menu driven operation supporting automatic graph scaling, labeling, and legend creation
- program default values may be set once and for all

\$49⁹⁵

CP/M-80

\$69⁹⁵

MS-DOS / PC-DOS

SCIENTIFIC APPLICATIONS

- simple interface allows plotting floating-point data obtained from all popular programming languages
- plot any number of curves (e.g. experimental data vs. theoretical values) on the same graph, choosing from 8 different plotting symbols.
- add up to 5 different-density grid lines, and choose from a wide variety of numerical labeling options
- high/low graphs are supported directly

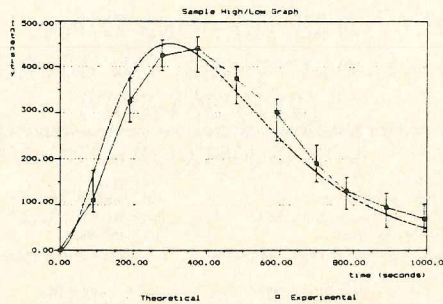
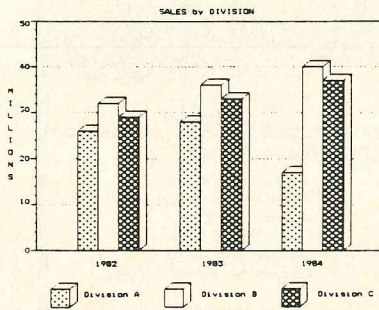

TERMS: We ship via first class mail. The above prices include \$5.00 for s/h. (Orders outside USA require additional \$5.00 for postage. NJ residents add 6% tax.) When ordering you MUST state your computer and printer make and model. We support MS-DOS (PC-DOS) version 2.0 or later on computers with at least 192k RAM, and CP/M-80 version 2.2 or later on Z80 computers (other than Apple) supporting a TPA of at least 54k (requires 64k of RAM). Most soft-sector disk formats are available. (If you can read several formats, please send us a list.) GRAF 3.0 works with any printer fully compatible with one of the following: Epson FX, RX, LX, MX (with GRAFTRAX), or LQ-1500; C. Itoh Prowriter; NEC 8023A, Star Micronics Gemini 10X, 15X, SG-10, SG-15, IBM Graphics Printer, Okidata 192, and earlier Okidata models equipped with the "IBM Plug 'n' Play" chips. (If you have an Okidata printer, other than the 192, the Plug 'n' Play chips are required!)

GRAF 2.0 Update Policy: Returning your original GRAF 2.0 disk to MSC entitles you to \$20.00 off the above prices.

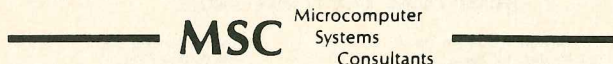

301 North Harrison Street CN5279, Suite 228 Princeton, New Jersey 08540

CP/M OR MS-DOS VERSION

FREE

With
Your Order For
Any 2 Or More Items On
These next 3 Pages Get a

Giant 12 Foot Coiled Extension Cord for Your Kaypro keyboard

Send for your free cord today.
Enjoy that detachable keyboard.
One Free Cord Per Customer

Regarding this coiled retractable cord: Don't be fooled by cheap imitations. This cord has been specially manufactured to match the unique electrical requirements of the Kaypro computer and meets demanding Kaypro-like specs. It is guaranteed to work with every model Kaypro II, IV, and 10. Don't settle for less from copycat advertisers. Other cords will fail and may hurt your system. Order your free cord today.

This free offer applies to any 2 or more separate items. For example, a Kaypro Quality Cover and one template equals 2 items; 2 templates equal 2 items, but a single box of diskettes is one item. We must reserve the right to end this offer. Don't be disappointed, order today. 12 foot cords sold separately at \$12.95 per cord.

● **Toll Free** ●

Order Desk Only
800-533-8049 USA
800-624-5628 CA

Information Calls
(805) 524-4189

CENTRAL COMPUTER PRODUCTS
330 Central Avenue • Fillmore, CA 93015
© 1985 Central Computer Products

Kaypro is a trademark of the Kaypro Corporation

Enemies of Kaypro®... Spikes, Surges, and Noise

The Kaypro has enemies. But now you can protect it from the mish mash of electrical currents that race through your home or business. Powerful up-surges of current can actually blow out your machine. Less powerful, barely noticeable spikes, surges, and noise can silently degrade your system in time, ruining chips, destroying data, and causing expensive service calls.

The Kaypro manual states, "Line filtering will protect your Kaypro...from power surges or other undesirable occurrences from the power source." Surge protection will help your Kaypro provide years of trouble-free service. Also, if you plan to use your Kaypro to access information by modem, you must have a reliable high frequency noise (EMI/RFI) suppressor to insure against data loss and scrambling.

There are many "toy" surge suppressors on the market. They are smartly colored, but beware. The performance difference is amazing. The best surge and noise suppressors on the market are made by Panamax. Our "Panamax Challenge Certificate" tells all. It is a startling comparison of Panamax quality with 11 other well-known brands. One aspect of this revealing report tells how Panamax responds to and cuts surges in 5 or less pico seconds, while most other suppressors respond at a comparatively slow 5 to 50 nanoseconds!

Check our regular low prices. Try the Panamax of your choice for 15 days. Receive the "Panamax Challenge Certificate" with your purchase. If not completely satisfied with your purchase, return for immediate full refund. Your Kaypro deserves Panamax protection, the best there is. Order today.

Introducing A Classic Form Fitting Kaypro Cover

At last, the classic Kaypro dust cover you'll be proud to own and use. This first rate computer cover is made from a premium, lint free, static free, washable, free breathing, and fade resistant sailcloth. It comes in a rich looking Navy blue or Royal blue, and has a smart contrasting silver gray piping and trim that adds a superior finished look. Made to form fit and protect a Kaypro that is set up and ready to use.

For a limited time only, your price for this factory direct, custom made, sailcloth Quality Cover is \$16.95. When ordering, remember to indicate color preference. This special low price is subject to change. You must be completely satisfied with this cover or we'll refund your money immediately. Order today.

Richly tailored inside and out. Look inside any of our Quality Covers; see the ultimate finishing; we use machines that sew with 3 needles so that no edge will ever unravel or shed lint. We stress perfection because you deserve the best. Compare for long-lasting satisfaction.

Kleertex®

- \$17.95 for one
- \$34 for two
- \$49 for three
- \$62 for four



your keyboard, software commands are only a glance away, at your fingertips. This makes it easy to learn programs that come with your Kaypro. Stop going back to the book to get a software command. Now you can learn software commands super fast, so you can make better use of your powerful programs. The expertly organized Wordstar/Mailmerge template, for example, gets you into word processing in half the time. A special dBase II template cuts through the learning curve like a knife and gets you programming sooner. Kleertex templates for CalcStar, Perfect Writer/Filer and Perfect Calc get you moving fast on these programs too. Once you try Kleertex templates, you'll wonder how you ever got along without these useful tools. Central's special price for one template is \$17.95. Choose any two templates for \$34 and save. If you like, you may combine purchase of any of these four templates for super savings. Complete satisfaction is guaranteed or money-back. Makes learning software a breeze. Great value. Order today.

Learn Software Commands Super, Super Fast

Now Available:
Wordstar/MailMerge
dBase II, CalcStar

Time-saving Kleertex templates are made from a durable, non-glare plastic, and can be put on and lifted off the keyboard instantly. The software commands on Kleertex templates are easy to read and are conveniently arranged in alphabetical order. With a Kleertex template on

MORE ON NEXT PAGE →

"Spikes and surges can be the greatest threat to your computer outside a 4 year old child with a jelly sandwich aimed for the disk drive slot."

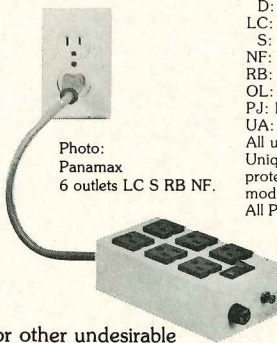

Photo:
Panamax
6 outlets LC S RB NF.

PANAMAX SURGE SUPPRESSORS

Description	List	Price
2 outlets, D NF	\$ 79.00	\$ 59.00
4 outlets, LC S RB NF	\$ 89.00	\$ 69.00
6 outlets, LC S RB NF	\$ 99.00	\$ 79.00
UltraMax, LC S UA NF	\$149.00	\$ 99.00
TeleMax, D IOL 2PJ NF	\$ 89.00	\$ 69.00

D: Connects direct to grounded wall jack.
LC: Includes 6 foot long heavy duty line cord.
S: Includes illuminated on/off switch.
NF: Includes EMI/RFI noise filter.
RB: Includes reset button.
OL: Includes outlet.
PJ: Includes 2 phone jack receptacles.
UA: Includes under voltage alarm/brown out protection.
All units include the added security of a 4 amp fuse.
Unique Panamax EMI/RFI noise filters provide protection in common and transverse mode. Essential for modem communications, multi-user stations, etc.
All Panamax units are factory guaranteed for 60 months.

"Power line-associated problems are estimated to cause nearly 70 to 90 percent of the malfunctions in the IBM PC."

"Overvoltage can be fatal to both data and hardware alike."
P.C. Magazine, March 1983

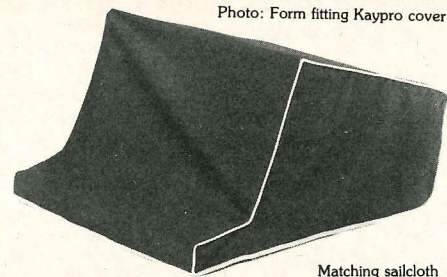

Photo: Form fitting Kaypro cover.

Matching sailcloth printer covers are \$14.95 each. Complete list sent with order.

New. Special two-piece Kaypro sailcloth cover. Set covers CPU and keyboard. \$19.95 per set.

- Quality tailoring
- Easy care fabrics
- Attractive colors
- Professional appeal

FACTORY DIRECT

Lockable Diskette Defender

Handsome, sturdy, smoke-tinted acrylic tray holds 70 Kaypro-size diskettes. Flip-up lid keeps out dust, debris, and moisture, and locks securely to guard your important work. Comes with 7 dividers that make for easy filing and keep floppies upright to prevent bending, warping, and scratching. Tough metal lock never comes in contact with diskettes because it is enclosed in a plastic housing. Super value at \$23 for one, or \$21 each if you buy 2 or more. Keep prying eyes and sticky fingers away from your important data. Order today.

Cables

Top quality, individually tested 36 pin Centronics-type standard parallel cables for all model Kaypros. These are made to work hard and long. Guaranteed.

- 5 ft cables ... \$19.95 each
- 10 ft cables ... \$25.95 each

Top quality, individually tested ribbon modem RS 232C cables designed with reinforced clamps for a sure continuous connection and made especially for your Kaypro. These work every time.

- 2 ft cables ... \$14.95 each
- 5 ft cables ... \$16.95 each

SmartKey II Plus Combo

—includes SmartPrint II Plus and Screen Smarts

Everyone's favorite keyboard redefining program is now on sale. Saves you thousands of keystrokes. **SmartKey** does not interfere with the regular function of your keyboard. Once you've tried it, computing will never be the same. Lets you save complex command codes, boilerplate paragraphs, inventory numbers, or whatever, and inject any of them into your work with the stroke of a single key.

Central's super priced **\$45 SmartKey II Plus** combo pak includes a free copy of **SmartPrint II Plus**, a program that greatly enhances the operation of dot matrix printers, and a free copy of Paul Golding's \$15.95 book, **Screen Smarts, The Computer Tamer's Guide**. This book tells how you can use SmartKey to turn your computer into a supercharged mean machine. Save time and money. Order today to get this hard hitting \$115 software & book combo for only \$45.

Text Filing Machine

Turn your Kaypro in to a powerful text filing machine. **SuperFile** is a textual matter database manager unlike any other. It puts you in control of your information. It allows you to easily store and retrieve notes, letters, random thoughts, contracts, depositions, invoices, new product information, sales reports, reference articles, scripts, abstracts, bibliographies, customer profiles, and much more. **SuperFile** accepts as many as 65,000 entries per database; allows 512,000 keystrokes per record, each of which can have up to 250 keywords; and indexes information you've stored on as many as 255 diskettes per database. Powerful.

Input for a **SuperFile** database comes from your word processor, so you can easily include information you already have into a database without having to re-key it. No fancy fields to define. This is a completely free-form database system. No programming language to learn. There's nothing difficult here. You can be up and running within minutes. **SuperFile** uses logical searching procedures to find your information fast. Save yourself the time and effort of filing and cross-filing information by hand or in overly structured data fields. **SuperFile** lists at \$195. Central's price is \$145. Order today.

Stop Tearing Up Your Disk Drives

If you're using your Kaypro as a printer buffer instead of a computer, you may be tearing up your disk drives. Disk drives are mechanical devices, they are often the first parts of a computer to go sour. No wonder. Everytime you feed your printer a file, the drives whirl madly until the printer has accepted the entire file. Sometimes this takes a long, long time.

If you're tired of hearing your disk drives grind down, you need a printer buffer. The best performance and price buffer on the market is the **Consolink MicroSpooler**. This computer-like tool absorbs files as fast as your computer can send them, and then patiently feeds or spools them to your printer a few bytes at a time.

The **MicroSpooler** is an intelligent, feature-packed buffer. It is easy to install and operate. Merely place it between your computer and printer, then connect it with two cables, and feed files as large as 64K within seconds to your letter quality or dot matrix printer. The instant the transfer is complete, you can operate your computer again. The **MicroSpooler** does the rest.

The **MicroSpooler** comes in a variety of configurations. You can link your Kaypro to any popular printer with two inexpensive cables. Please check our low **MicroSpooler** prices. You won't find a more feature-packed or reasonably priced spooler around. Try the **MicroSpooler** of your choice for 15 days. If you are not completely satisfied with your purchase, return it for an immediate full refund. Your Kaypro deserves this attractive and useful accessory. Order a compact and powerful **MicroSpooler** for your computer today. Works with all model computers.

Central Computer Products

330 Central Avenue
 Fillmore, California 93015
 (805) 524-4189

Mail Order service you can depend on.



- Personal Service
- Low Prices
- Fast deliveries
- Tele-Support

Price Protection Policy

Central Computer will meet or beat any price listed in this magazine on products also advertised in our ads. If you see a lower price, please tell us. We'll beat that price and pay shipping too. Try our lightning fast service today. Thank you.

Full Power Computing

T/Maker Integrated is a highly acclaimed powerhouse program that can turn your CP/M Kaypro into a computing workhorse. At last, you can enjoy productive computing like never before. Imagine doing full-featured word processing, relational database management, spreadsheet analysis, horizontal bar chart graphics, and checking your spelling all within the same program. No more switching back and forth between barely compatible programs to accomplish these simple tasks. **T/Maker Integrated** is universally acknowledged as a unique integrated software system that is just plain easy to learn. There is an alternative to doing things the hard way. **T/Maker** can put the hidden and largely untapped power of your Kaypro at your command. **T/Maker Integrated** is regularly \$450. Central is proud to offer this outstanding package for the low, low introductory price of **\$179**. Yes, this includes the entire feature-packed **T/Maker** package, so please treat yourself to this excellent super productive software today. Experience the power of true software integration on your Kaypro. Order **T/Maker** today. Get it fast.

The Kaypro can dump a file faster than a printer can accept it. This device will catch the file, quiet the disk drives, and let you compute again.

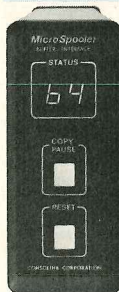

Photo: MicroSpooler 64 K P-P

CONSOLINK MICROPOOLERS

Description	List	Price
64 K P-P	\$315.00	\$279.95
64 K P-S	\$343.00	\$299.95
64 K S-S	\$349.00	\$299.95
64 K S-P	\$339.00	\$294.95
Two Cables	\$ 56.00	\$ 29.00

- 64 K Stores and spools files as large as 64 K.
- P-P Parallel Kaypro port to parallel printer port.
- P-S Parallel Kaypro port to serial printer port.
- S-S Serial Kaypro port to serial printer port.
- S-P Serial Kaypro port to parallel printer port.
- Cables Set includes one special male to female connector and one male-male connector.

Includes these unique features:

- Status digital readout
- Multiple copy function
- Temporary pause function
- Sleek internal power supply
- Comprehensive self test routine
- Slimline attractive casing
- Front panel reset
- 12 month factory guarantee

Toll Free Order Desk

800-533-8049 USA
 800-624-5628 CA

Product Description	List	Central
Kaypro Software		
ATI TRAINING SOFTWARE		
CP/M	\$ 39.95	\$ 33.00
MBasic	\$ 39.95	\$ 33.00
Microplan	\$ 75.00	\$ 57.00
Multiplan	\$ 75.00	\$ 57.00
Wordstar	\$ 75.00	\$ 57.00
BORLAND INTERNATIONAL		
Turbo Pascal 3.0	\$ 69.95	\$ 58.00
Turbo Toolbox, Software Tools	\$ 49.95	\$ 44.00
Turbo Tutor, Step by Step	\$ 34.00	\$ 29.00
CDE SOFTWARE		
Checks & Balances	\$ 74.95	\$ 54.00
CHUCK ATKINSON PROGRAMS		
Quick Check + AR	\$195.00	\$149.00
Retail Inventory + Q Register	\$395.00	\$289.00
Quick Check Money Manager	\$ 95.00	\$ 69.00
— Recommended for comprehensive ease of use		
COMPUTER EDITYPE SYSTEMS		
Magic Print ★	\$195.00	\$155.00
Magic Bind ★	\$250.00	\$199.00
Magic Index — includes ★	\$295.00	\$245.00
— All superior Wordstar enhancers		
COMPUTERSONIC		
VersaBusiness Series		
VersaLdger II	\$149.95	\$115.00
Any other modules	\$ 99.95	\$ 79.50
CONSULTANT SYSTEMS		
The Real Estate Consultant	\$399.00	\$349.00
With The Creative Loan Consultant		
— Don't buy or sell property without this software		
CONTINENTAL SOFTWARE		
Home Accountant Plus	\$ 99.95	\$ 79.95
DATA DECISIONS, INC.		
KBAR, K-10 backup utility	\$ 89.95	\$ 69.00
DIGITAL MARKETING/PRO TEM		
Bibliography	\$ 99.00	\$ 84.00
Datebook II	\$150.00	\$115.00
Footnote and Pair ★	\$ 99.00	\$ 79.00
Grammatik ★	\$ 75.00	\$ 69.00
Hyper Typer, Typing Tutor	\$ 39.95	\$ 32.00
Index ★	\$ 99.00	\$ 87.00
Milestone, Project Planner	\$250.00	\$199.00
Bibliography and Footnote	\$150.00	\$130.00
Notebook	\$150.00	\$119.00
Writer's Pak — includes	\$250.00	\$199.00
— all ★ products and Random House Checker		
— Call for prices on other DM or PT products		
EAGLE ENTERPRISES		
Citation	\$185.00	\$155.00
General Ledger	\$185.00	\$135.00
— easiest to use full-featured GL available		
FYI, INC.		
FYI 3000	\$395.00	\$299.00
SuperFile with Sort & Merge	\$195.00	\$149.00
Free form textual matter database managers		
— Index material spread over 255 diskettes		
INFOCOM		
Enchanter	\$ 39.95	\$ 37.00
Deadline	\$ 49.95	\$ 46.00
SeaStaker	\$ 39.95	\$ 37.00
Infidel	\$ 44.95	\$ 42.00
Witness	\$ 39.95	\$ 37.00
Zork I	\$ 39.95	\$ 37.00
Zork II & III each	\$ 44.95	\$ 42.00
— Call for prices on other Infocom products		
MENDOCINO SOFTWARE		
Eureka, Disk Cataloger	\$ 50.00	\$ 48.00
helps you find the right file instantly		
MICROSOFT		
MBasic Compiler	\$395.00	\$299.00
MultiPlan	\$195.00	\$149.00
MICROSOLUTIONS		
Uniform Kaypro II/2	\$ 69.95	\$ 49.95
Reads 32+ machine formats		
Uniform Kaypro 2X/IV or 10	\$ 69.95	\$ 49.95
Reads 90+ machine formats		
MYCROFT LABS		
Compat	\$ 99.00	\$ 89.00
Mite Communications	\$150.00	\$ 99.00
Mite Plus Terminal Emulations	\$175.00	\$130.00
NORTHWESTERN ANALYTICAL		
StatPak	\$495.00	\$399.00

Toll Free Order Desk

800-533-8049 USA
800-624-5628 CA

Product Description List Central

Kaypro Software - continued

PEARLSOFT		
Personal Pearl	\$295.00	\$165.00
— Easy to use, top flight database manager		
PLU PERFECT SYSTEMS		
Plu Perfect Writer CP/M 2.2E	\$ 39.95	\$ 31.00
Backgrounder	\$ 45.00	\$ 38.00
CP/M 2.2E only	\$ 32.00	\$ 27.00
Date Stamper	\$ 39.00	\$ 29.00
Data Stamper, General CP/M	\$ 49.00	\$ 39.00
QUIC-N-EASY PROD.		
Q-Pro-4	\$595.00	\$395.00
— World class database manager. Many built-in super features including multikey file indexing		
ROBONICS		
Grafiks 2.4	\$125.00	\$ 99.00
Graphic Express	\$125.00	\$ 99.00
Office Express Client Billing	\$295.00	\$225.00
Stardrive, Wordstar Tools	\$200.00	\$159.00
— with thesaurus, checker, graphics, math pak		
SAN FRANCISCO COMP		
Power!	\$149.00	\$ 99.00
DocuPower!	\$149.00	\$ 99.00
SCIENTIFIC MARKETING		
MarketFax	\$495.00	\$359.00
— Dynamic computerized sales generating tool		
SOFTCRAFT		
Fancy Font 2.0	\$180.00	\$149.00
SOFTWARE RESEARCH TECH		
dFastest —	\$ 89.00	\$ 69.00
— sorts dBase II files 33 times faster		
SOFTWARE TOOLWORKS		
Eliza	\$ 24.94	\$ 22.00
MyChess	\$ 34.95	\$ 29.95
Word Wiggle	\$ 29.95	\$ 27.00
C/80	\$ 49.95	\$ 45.00
— Call for prices on other Toolworks products		
SORCIM		
SuperCalc 2	\$295.00	\$235.00
SPECTRE TECHNOLOGIES		
Rembrandt 3.0	\$ 79.95	\$ 52.00
STAR SYSTEMS		
The Accounting Partner	\$395.00	\$275.00
Accounting Partner Integrated	\$795.00	\$599.00
Upgrade AP to AP Integrated	\$400.00	\$329.00
SUPERSOFT		
Disk Doctor	\$100.00	\$ 75.00
T/MAKER COMPANY		
T/Maker Integrated	\$450.00	\$179.00
WRITING CONSULTANTS		
Proportional Star	\$ 75.00	\$ 69.00
Math Star	\$ 49.95	\$ 45.00

Hardware

DATASOLVERS		
DS300 Baud Smart Modem	\$199.95	\$165.00
DS1200 Baud Smart Modem	\$349.95	\$295.00
— Internal modems for all model Kaypros		
PANAMAX		
PowerMax —	\$559.00	\$399.95
250 Watt Battery Back-up		
SWP MICROCOMPUTER PROD		
256k CoPower-88 MSDOS	\$399.95	\$369.00
256k CoPower-88 Plus	\$649.95	call
— Plus boards are expandable up 1 megabyte		
— Use as RAM disk or MSDOS computer		

Diskettes

Dysan SSDD Kaypro 2/II disks	10/box	\$ 23.00
Dysan SSDD 2X/IV/10 disks	10/box	\$ 29.00
3M SSDD Kaypro 2/II diskettes	10/box	\$ 18.00
3M DSDD 2X, IV/10 diskettes	10/box	\$ 23.00
3M Head Cleaning Kit	\$ 32.00	\$ 21.95

Bookware

Compleat Kaypro II, IV & 10	\$ 16.95	\$ 15.00
CP/M for the Kaypro	\$ 16.95	\$ 15.00
with an Introduction to dBase II		
Kaypro WP Plain & Simple	\$ 13.95	\$ 12.50
Using CP/M on Kaypro 10	\$ 19.50	\$ 18.00
Screen Smarts, Tamer's Guide	\$ 15.95	\$ 12.95

Free yellow Hi-Liter pen sent with every book order. Prices, specifications, and offers subject to change without notice.

Do You Wish Writing Was Easier?

If you need to write, or want to write clearly, your Kaypro and the software program **Punctuation and Style** can help you get there faster. It improves, clarifies, and enriches your writing by identifying sentences with misused, redundant, faulty, cliched, or erroneous phrases, and shows you how to improve them. It helps you rewrite and check your work by quickly marking and annotating your files for easy correction. In addition to computer-fast identification of awkward, muddy, pompous, and wordy sentence structure, it also finds missing or improper punctuation, unbalanced quotes, wrong abbreviations, faulty capitalizations, and much more. **Punctuation and Style** actually improves your writing by mercilessly pointing out grammatical errors. After a few weeks with Oasis System's **Punctuation and Style** your writing is bound to become more dynamic, expressive, and honest. In time, you'll stop worrying about grammar and work on projecting ideas instead. After all, that's what writing is about.

Punctuation and Style makes writing and rewriting much easier. The list price of **Punctuation and Style** is \$125. Central's price is \$95. Experience the power of this valuable "Punctuation Checking and Writing Improvement Software" yourself. Order today to get this program fast.

Punctuation and Style works on files created with Wordstar or Perfect Writer. It comes with an easy to use, clearly written manual and is packaged in an attractive binder. Join thousands who now write with more confidence, faster, and better.

90,000 Word Thesaurus at Your Fingertips

Synonym Finder by Writing Consultants is a 90,000 word thesaurus that is guaranteed to make you and your Wordstar a precise and powerful online writing machine. **Synonym Finder** is so easy to use that after one or two searches there's no turning back. Your speaking and writing vocabulary will improve dramatically as you use this program to display and study a rich variety of words at the push of a key.

Synonym Finder was compiled by a team of lexicographers. It is extremely fast and works within Wordstar, so you never have to leave your file to use it. Just put your cursor on a word in your text, press the escape key twice, and a list of synonyms appears. Then press a key if you want to select and automatically place an alternate word in your onscreen text. **Synonym Finder** will help you find the exact word you need to properly express your thought. **Synonym Finder** retails at \$124. Central's current low introductory price is \$69. This offer may not be repeated. Please order today.

Attention: **Synonym Finder** works with all Kaypros. Gives Wordstar text files new vim, vigor, and punch.

Cordura Travel Case

This full featured, padded carrying case is made from a super-material called "cordura." This material is rip, shred, and water resistant. The Coverman Kaypro case comes fully padded and lined, so your Kaypro is protected from unexpected bumps and jolts. Since your Kaypro is completely enclosed in this case, it keeps rain, sand, and other debris out of your machine. The Coverman case comes with external carrying handles and a detachable strap with a non-slip shoulder pad that comes in handy when you have to carry your Kaypro over a long distance. There is also a large interior pocket perfect for transporting manuals and diskettes. The Coverman Kaypro carrying case is regularly \$79.95. Central is proud to offer this expertly constructed case at \$59.95. Please indicate your choice of color: silver-gray, dark blue, or brown. All straps and carrying handles are black. You must be completely satisfied with your purchase of this handsome travel case or receive a refund immediately. Order today.



Perfect Kaypro® Stand

Simple, strong, sturdy, safe. These words describe an attractive, angled stand that provides a perfect spot to place your Kaypro.

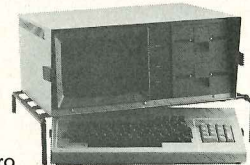

This stand is made from rounded, steel rods covered with a thick, shiny, soft, black polymer material that protects your Kaypro and table top from scratches. Unlike flat wood or acrylic panels used in other stands, the tough supporting rods of the Smart Stand (TM) do not obstruct air flow. In fact, since your Kaypro is lifted off the table top and gently angled by this stand, air rises up from under your computer, and flows freely through it to help keep it cool. When you're finished computing, you can slide the keyboard completely under the stand to create a working area on your desk. The Smart Stand is a super value at \$34.95. Try it for 15 days. If not completely satisfied, send it back for a full refund. Matching 80 or 132 column printer stands are only \$19.95 or \$23.95. Order today to get the Smart Stand fast.

CENTRAL COMPUTER PRODUCTS

330 Central Avenue, Dept. 9A
Fillmore, California 93015
(805) 524-4189

Dear Central,

Please send me the items listed below. I want fast, friendly service. Remember to include my free 12 foot extension cord. I understand there is no charge for this cord if I purchase 2 or more items from these 3 pages. My check, money order, or card no. is enclosed. Thanks.

Description	Price
_____	_____
_____	_____
_____	_____
_____	_____
_____	_____
_____	_____
Kaypro Model _____	Sub Total _____
_____	CA Resident 6% Tax _____
FIRM MONEY BACK GUARANTEE	Postage & Handling \$ 3.00
ORDER WITH CONFIDENCE	Total \$ _____
<input type="checkbox"/> Navy blue	<input type="checkbox"/> Royal blue
<input type="checkbox"/> Send free catalog	<input type="checkbox"/> Send free 12 foot cord
<input type="checkbox"/> Check enclosed	<input type="checkbox"/> Money Order enclosed
<input type="checkbox"/> Visa/Mastercard # _____	
<input type="checkbox"/> American Express Card # _____	
Exp. Date _____	Sig. _____
Name _____	
Address _____	
City _____	State _____ Zip _____
Credit card phone orders welcomed. Call toll free.	
To order by mail use coupon, letter, or photo copy. Thank you.	



No More Pencils, No More Books

Finding educational software for CP/M

by Jim Spickard

Educational programs for CP/M computers: they exist, but you have to be a software sleuth to find them. They're not so much hidden as they are out-hyped by the graphics-oriented programs utilized by other operating systems. Color and animation make for a more enticing ad, so those are the programs you see in most magazines.

If you look beyond the razzle-dazzle, you'll find that CP/M programs pertaining to education abound. To fill you in on what's out there, we've chosen to adopt a broad definition of "educational." This definition takes in everything from drills for children to administrative tools for teachers.

While no CP/M computer can match the wealth of programs written for the Apple, Commodore, Atari or TRS-80, there's still a lot of useful stuff out there. From grammar-schooler to adult, there's something for just about everyone.

And despite popular belief, more is being written. As software developers realize the potential market in all the CP/M-based hardware still very much in use, our educational choices are apt to grow. We won't get flashy high-tech video games. We probably won't even get many programs that use the newer Kaypros' graphics capabilities.

But good, effective learning tools are already available, and more are on the way. You just have to hunt a while to find them. This article should make your hunting easier.

Software types

Schoolhouse software comes in several types. First there's the kids' stuff—what we usually think of when the term "educational software" is mentioned. These programs give one-on-one instruction, freeing the teacher for other tasks. Drills and games teach everything from arithmetic and state capitals to chemistry and nutrition.

The best of these programs entertain while they teach. The worst are as boring as the wearisome ped-

ants they replace. Though dancing color pictures won't grace CP/M Kaypro screens, *Adventure's* popularity proves such embellishments unnecessary. The "graphics of the mind"—when guided by good software—can motivate learning quite nicely.

Software that teaches you about *other* software makes up a second category. Some run like a typical schoolroom, where the subjects are CP/M and Word-Star, not calculus. They guide you through your software, letting you practice simple tasks with assistance always at hand. (One program even prints a graduation certificate when you've passed its tests.)

Logo is perhaps the most imaginative such learning tool (see "It's Not Just For Kids" in the September 1984 *PROFILES*). You think you're just moving turtles, but you're actually learning how to program.

Then there are programs for teachers. Automated gradebooks and test preparation routines aid teachers in keeping track of student performance while cutting down out-of-class drudgery. Richer and more lively teaching follows. (And, one hopes, less teacher burn-out.) Here Kaypros can compete with the "big boys," and at a price most teachers can afford.

I'll take each of these categories in turn, and sample the software I've found. You'll get an idea of what's out there—though there's surely some I've missed.

Math time

Let's start with the young 'uns. A lot of kids have trouble with math. Come to think of it, so do the rest of us, as my bank faithfully informs me every month.

Resource Software International (RSI) sells 12 program modules covering basic arithmetic for grades 1-5, seven more for grades 5-8, and a high school series covering algebra, trigonometry and calculus. The programs emphasize drill: "no bells and whistles," the manual says, "just honest-to-goodness course material." They don't teach concepts, but kids can practice their skills at whatever pace they want.

Let's Have Fun Counting and *Let's Have Fun Com-*

paring (for grades 1-3) start kids off counting stars and letters, typing in correct answers at the prompt. Then come the four basic operations (addition, subtraction, multiplication and division), each with several programs of increasing complexity. Help comes with the touch of a button, and students are encouraged to redo lessons until they've mastered them. Different questions are presented each time to prevent boredom.

Of course, drill is drill: it's pretty boring by nature. How much thrill can there be in subtracting 3,287 from 4,003? But you only really learn arithmetic by practice, and RSI is a whole lot more fun than the flashcards I remember.

The "graphics of the mind," guided by good software, can motivate learning quite nicely.

For one thing, you aren't embarrassed when Sally Smith gets the answer right and you don't. Failures aren't so public when it's just you and your computer.

Besides math, RSI publishes units on junior high school English—vocabulary, grammar and letter writing—and senior high school chemistry. Their *Automated Test Author* (see below) lets you set up drills on any subject. They also offer the *College Board Score Builder* for help in taking the SAT (reviewed elsewhere in this issue).

Teacher's Aide, a bargain from Dynacomp, is similar to RSI's grade school units in that it drills on the four basic operations of arithmetic and allows self-paced learning. It lets you work on addition, subtraction, multiplication and division at five different skill levels. You can break your work down into steps if you want—just like you do on paper. Since the program runs under MBASIC, it's simple to add features. I'd clean up the screen, and perhaps include a few more instructions. And I'd program it to enter numbers from right to left like we do in real life. (Think about how you multiply.) But for plain vanilla it's just fine as is.

If you tire of drills (and who doesn't) you might look at *Numbers and Math*, by Advent Products. According to Mark Swanson, its author, the disk is game-oriented: two-person number guessing, an imitation car race called "MPG" (miles per gallon) and several others. It's aimed at the preschool to third grade set.

A companion disk, *Letters and Language*, carries several word games that range from helping kids learn the alphabet to building vocabulary. Swanson says some of its games will please older kids, even adults. Both disks are written in MBASIC, so you can easily modify them if you want.

I don't know about Swanson's games, but drill programs for younger children have one flaw. To run a

program, you have to read. To get right answers, you must follow instructions printed on the screen. Can first-graders read well enough to know they're supposed to count the stars and type in the proper number? RSI, particularly, doesn't match its instructions to its grade level. And since not all the questions on its quizzes are of the same type, you can't just turn little kids loose here: you have to help them along.

And the winner is . . .

But enough of math! How about some more creative learning?

The most enjoyable programs I found were *Nutribytes* and *Eco-Paradise* from Public Interest Software, two games that teach nutritional and ecological awareness.

Eco-Paradise has two parts: a game in which you try to get to from the City of Darkness to Paradise by the shortest route, while avoiding the toxic waste dump; and an "Eco-Test" that rates the ecological soundness of your lifestyle.

The game is like a quiz. Right answers move you ahead, while wrong answers take you miles from your goal (but bring you closer to the dump). You can call on a friendly ecologist for help on the tough questions; the answers to early questions help you later on. I never felt talked down to—just involved.

"Eco-Test" is more polemical. For example, you lose points for overheating your house, or for even *owning* a car, though fuel-efficiency helps. (So how are you supposed to get to work where public transit and close-in affordable housing are lacking?) But the program doesn't just blame the individual: you get points for political involvement to cure such social ills.

Nutribytes has three modules: "Eats and Drinks" teaches basic nutrition; "Chemical Cuisine" teaches about food additives; and "Chef Pennypincher" helps you rate your current diet for wholesomeness and expense.

The first two, particularly, are full of useful information. Did you know that Yellow #6, an artificial color, is probably safe, but Yellow #5, much more widely used, causes allergic reactions in those sensitive to aspirin? Or that packers use ferrous gluconate to turn olives black? (It's a safe additive, unlike about 50 percent of the chemicals currently used.) Now you do, thanks to *Nutribytes*.

These programs are winners because they make learning fun. The subjects could be deadly dull, despite their importance. But here I learned without even noticing it. The care that went into the design of these two programs shows.

Computer literacy

As you can see, I prefer games to drills. Drills have their place, and rote learning on a computer beats flashcards all hollow. But conceptual learning needs something more. Fortunately American Training Inter-

national (ATI) and Software Academy have done something more with their computer literacy products.

Let's take ATI first. ATI publishes two sets of programs to aid the computer user. *Skill Builder* introduces the novice to computers, operating systems and the simpler software like Perfect Writer and MicroPlan. *Training Power* provides both beginning and advanced instruction in such complex programs as dBASE II and WordStar.

Training takes place on a split screen. Half the screen simulates the software or hardware, while the other half provides step by step instructions. By practicing the actual keystrokes, you get hands-on experience. An electronic guide makes sure you don't crash and burn.

I tried the *CP/M Skill Builder*. While not deep, it's an adequate introduction to DIR, TYPE, STAT, PIP, ERA, SYSGEN and some of the other CP/M utilities. It even introduces ED, that seldom-used line editor that I occasionally wish I knew better (but don't want to brave the CP/M manual to learn). It leaves out a lot of information, but the basics are there.

Software Academy's *Professor 3T* takes a different tack. *Professor 3T* wants to make you "computer literate," and gives you lots of general concepts while introducing you to your operating system. Modules cover CP/M, MS-DOS and CP/M-86, but not application software like WordStar.

3T is built like a school, complete with registration, classes, tests and diplomas. There's even a teaching assistant, Genie, to help you out when times get rough. (Be warned: Genie's sense of humor can only be

*Drill programs for
young children have
one flaw: to run them,
you have to read.*

described as "strange.")

Like most schools, *3T* relies a lot on lectures. This gets tiresome, since it's even harder to read a green-on-black screen than to listen to a droning professor. But there's just enough interaction (and testing) to keep you moving. And the payback is the wealth of material you get. *3T's* CP/M version treats DIR, STAT, PIP and so on in depth—much more thoroughly than does ATI, except that ED isn't covered.

The program has a glossary of computer terms, a general introduction to personal computing and other attributes that recommend it to the novice. Software Academy expected to release its enhanced version before press time. This version incorporates more user-response during the lectures (good!). A special artificial intelligence routine will individualize instruction, gearing it toward the topics where you need special help.

If you just want to learn BASIC, you might try the *BASIC Tutorial* from Advent Products, which covers all but the most advanced aspects of BASIC.

Teacher's aides

As a teacher, what's the most wearisome thing you have to do? If you're like me, there's no question: it's making and grading exams! No matter what your pedagogical theories, exams are drudgery. I always put them off, and then have to stay up the night before, deciding which questions I want to ask. And I've got to be sure this year's exam isn't too much like last year's. They learn capitalism (exam-selling) young where I work.

Automated Test Author (\$89.99 from RSI) solves some of these problems. It stores test questions and constructs exams automatically, varying the questions according to your needs.

Let's take my sociology class as an example. My students need to master a 100-term vocabulary, and I like them to answer 10 or so short-essay questions on each test. Sometimes I use fill-ins, multiple-choice and true/false for the facts they just can't avoid. This year I typed in the terms and about 60 essay ideas and instructed *ATA* to choose 25 terms and several essays for the final exam.

ATA did exactly that, choosing the questions at random. Each test is different. I made three versions, one for the class as a whole and two others for students having to be tested at special times. No worry about possible cheating; no having to type all night. I just pushed a few buttons and watched the exams roll off the printer.

And there'll be even less work next year. I'll revise the questions a bit, reset the random generator and have a new test to play with.

One problem, though: *ATA* can only write exams to the printer or to the screen as interactive drills. It won't write to disk for later editing.

This means that if you want to leave the multiple choice off a particular exam, you have to toss out those pages after they're printed. (You'll get used to exam pages numbered 1, 2, 4, 7 . . .) You also can't revise headings, footings and other decorations, but RSI made some pretty good choices here—the exams are easy to read.

If you don't like the particular questions the program has chosen, you can only run it again until it comes up with something acceptable—no after-the-fact editing is possible.

But the idea is good, and it saves me enough work that I'll live with it.

ATA lets students take tests right at the Kaypro and scores all questions with true/false, multiple choice and single-word answers. (It can't score essays for obvious reasons.) It works just like RSI's other drills (surprise), which means it's a pretty good learning tool.

Master Drill, by Dynacomp, also lets you set up interactive drills on any subject. Do your students need

“After using your “Help” books, I am hesitant to purchase any software without checking to see if you have published a book on it.”

Houston, TX.

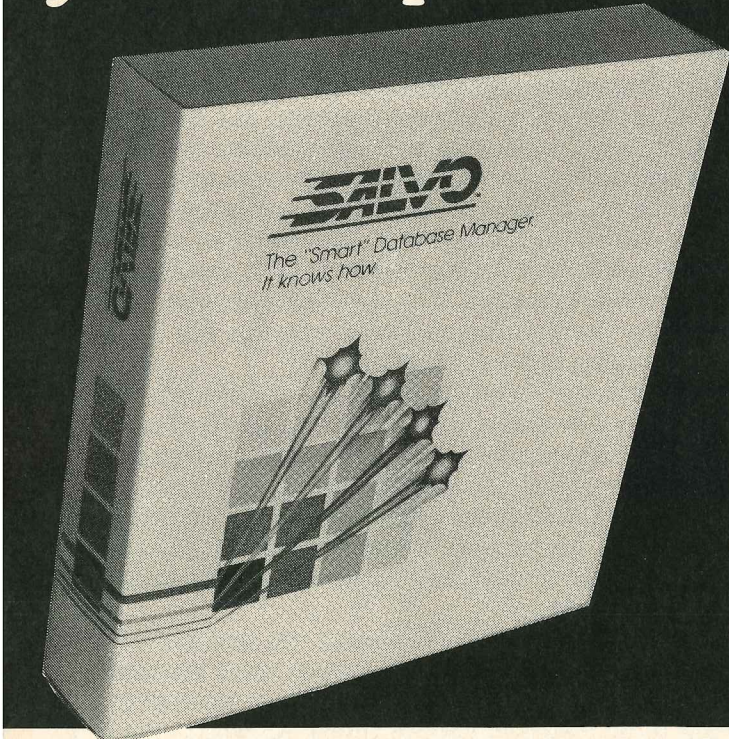

SALVO THE ULTIMATE DATABASE™
Introductory Price JUST \$94.95

- Fully Relational Database
 - Uses up to 16 files at one time
 - Natural Language Interpreter
Talk to SALVO in English!
 - Powerful 4th Generation Language
Write whole programs in 2 or 3 lines
- MONEY-BACK GUARANTEE!**

From Plu*Perfect Systems, Inc.
CP/M 2.2e plus Plu*Perfect Writer™ \$31.95

“A wonderful program that enhances the features of Perfect Writer.” Peter McWilliams

Plu*Perfect Backgrounder™ \$37.95

“The only thing more amazing than the performance is the price!” Peter McWilliams

NEW! Plu*Perfect Datestamper™ \$31.95
 Automatically time and date stamps your files.

NEW! Perfect Software Version 2.0
 Writer, Filer and Calc
NO COPY PROTECTION!
 Normally \$89 Our Price: **\$85 All 3 \$225**

AT LAST! The PeopleTalk book you’ve been waiting for.

The All Star Guide to the Kaypro Computer In PeopleTalk’s learner-friendly style covering

- WordStar™ • DataStar™ • MailMerge™
- ReportStar™ • CalcStar™ • SuperSort™

Written in cooperation with Kaypro Complete easy to read tutorials on all of the Star software; starts with basics — builds to advanced uses; expert tips and advice; fully cross-referenced; fully indexed; spiral-bound for easy access

Introductory Price **\$19.95**

THE PEOPLE TALK QUARTERLY

60 pages and going strong! A newsletter written in plain English. Columns covering—

- Star software
 - Dbase-II
 - Product reviews
 - In-depth articles
 - Public Domain Software
 - Tricks for getting the most from your printer
 - Perfect software
 - Book section
 - Modems & Communications
- Normally \$20 (4 issues) **Special Price \$17.95**
 Back issues \$2.50 each

KAYPRO 10 USERS

KBACK — The ultra high speed back-up program. Dumps 10 megabytes in 15 minutes!
JUST \$69.95

FASTBACK™ — The highly praised back-up utility. See the review in February Profiles
 Normally \$99.95 **Our Price \$74.95**

PASSWORD™ — The ultimate security system. Gives you total control over who has access to your computer. From start-up to shut-down PASSWORD follows your instructions about who may have access and what areas they may use.
JUST \$69.95

REMBRANDT™ - GRAPHICS FOR YOUR KAYPRO

Thousands of copies sold at \$79.95
 Our price only **\$57.95 Demo Disk \$6**

"...the very best collection of utility software I've seen...The Kaypro is advertised as "The Compleat Computer"-but this is the bundle of software that makes that true!"

Dave Gerrold, Profiles Magazine

FREE SOFTWARE HANDBOOK ONLY \$17.95

(Handbook plus software disks \$62.95. Disks only \$54.95.)

Features the top programs in public domain

- What they are
- When they're useful
- How to acquire them
- How they work

*If ordering disks please specify machine and disk format.

Also from PeopleTalk:

- Wordstar and Friends for Kaypro 2 & 4 **\$19.95**
- Perfect Manual for the Kaypro 2, **\$17.95**
- Perfect Manual for the Kaypro 4, **\$17.95**

Supercharge your Kaypro with Smartkey!™

Only \$44.95 to customize your computer. Program your own keyboard to turn the most-used commands into ONE KEYSTROKE.

PERFECT WRITER ON THE KAYPRO™

Easy-to-read tutorial for Perfect Writer users. Unleash the power of Writer with this handy reference book as only PeopleTalk could produce it!

- Exceptional type-this-and-you-get that reference section lets you look up a command quickly and easily
- Focuses on all Kaypro models

All this for only **\$17.95**

DISKETTES! Special 25 disk prepacks

Single-Sided: **\$1.25** each **\$31.25** Box

Double-Sided: **\$1.45** each **\$36.25** Box

Includes warranty, envelopes & labels

CHECKS AND BALANCES

"The sky opened with a crack of thunder ... My checkbook had balanced ... It hadn't balanced in 17 years. If anyone had told me that I would be balancing my checkbook and enjoying it, I'd have suggested he was a candidate for a rubber room!" Dave Gerrold Profiles

The incredibly easy-to-use accounting package for personal and business use.

Super-low price **\$54.95**

MONEY-BACK GUARANTEE



See your dealer or order direct:

PeopleTalk Associates Inc.

P.O. Box 863652-A

Plano, TX 75086

1-800-PT BOOKS



Please include product price in U.S. Dollars + \$3 shipping and handling (\$10 air mail outside U.S.) Texas residents add 6% tax.

to memorize the state capitals? Or chemical terms? Just feed in the state and city names, or your vocabulary list, and presto, you have a multiple-choice drill.

Wrong answers are selected at random from among the right answers to other questions. A score is kept, and the questions missed are repeated until they're done properly.

Memory helps you memorize text: you're prompted word by word until you can repeat it.

Admittedly, the program's not as complex as the interactive drills outlined above. You're stuck with multiple-choice and you can't print exams like you can with *ATA*. About the third question your students answer wrong, they'll tire of the "Nice try but it is not correct!" message. But *Master Drill* runs under MBASIC, so you can list and modify it however you want. You could vary the messages, set off the bell—whatever you need to make things more lively.

Language Tutor and *Memory* from Telion Software are two other drill programs adaptable to any subject.

Language Tutor works like flashcards: you build a file of "words" and "definitions" (which could be math, for all the program cares) and are then quizzed for the right answers. These must be typed exactly. You get three tries, then the right answer appears. I tried a "State Capitals" test on both *Master Drill* and *Language Tutor*, and frankly I prefer the latter. I learn more by direct answers than I do by multiple choice. And the program is easier to use.

One problem, though: the "chiding comments" *Language Tutor* gives to wrong answers are downright offensive. They vary so you won't get bored, but you may shut off the machine in disgust. I spoke with Telion, and they said they'd tone them down. Positive reinforcement makes for better learning, in my view.

Memory helps you memorize texts. You type in whatever you want to learn and are prompted word by word until you can repeat it correctly. Words can be entered by typing just the first letter, so typing slips don't strike you down. You can peek ahead, or set the program to return to the beginning after each mistake. It counts your errors and lets you review the lines you missed until you get them right. Actors, particularly, will find this program useful. Theology students who want to memorize Scripture will also be pleased.

I saw *Memory* in beta-test, but found no bugs or objectionable features. The final product should be out by the time you read this.

Various companies market automated gradebooks, another standard teacher's need. *Teacher's Gradebook*, also from Dynacomp, looks quite flexible. It can record up to 15 small classes and five large ones on each disk, keeping track of grades, absences and so on for each. You can even set a password to keep records from prying eyes.

Now if someone would automate all those state-mandated achievement forms, so we teachers wouldn't have to spend our lives doing paperwork . . .

Loose ends

Adventurous souls may want to look into a couple of other programs that for various reasons I didn't get to see in action.

Dynacomp markets *Spell Master* and *Crypto*, two word games that help build vocabulary and reading skills. The same company sells *Management Simulator* for educating proto-capitalists, and *Trivia Mania* for trivia buffs.

Teachers who want to write their own modules might call on the *Torricelli Series* by The Answer in Computers. This set of programs helps you develop your own computer-assisted instruction, from software writing to presentation.

And I'm sure there's more! The only way to find what's there is to go looking for it. Happy hunting! □ *Jim Spickard teaches college sociology. He frequently reviews software for PROFILES.*

(continued on page 83)

Inventory Control



Manufacturer's System - meets the unique need of manufacturers with bills-of-materials, parts required projections, "where-used" summaries, work-in-process, interactive Purchase Order system, and more. Interactive Sales Invoicing option available. **\$595.00**

Point-Of-Sale System - designed especially for retailers and distributors. Prints invoices; automatically adjusts inventory; includes multiple costs, locations, and vendors; provides detailed sales and profitability analysis. Interactive Purchase Order option available. **\$495.00**

General Inventory System - a comprehensive system useful to any business, it includes multiple costs, vendors, and locations, sales history, and detailed reports. Purchase Order and Sales Invoicing options available. **\$295.00**



Supported by an established company of professionals that has grown through customer satisfaction since 1976. You take no gamble with this proven firm!

Demo Systems are available that include the comprehensive manual and software with sample data.

Call or write for a detailed brochure today.

Available on CP/M and MSDOS



Box 668 • Encinitas, CA 92024

(619) 436-3512 • Dealer inquiries invited

Computerware is a federally registered trademark of Computerware.

Kids and computers: A parent's perspective

by Linda McPherson

How do children learn? Psychologists, who rarely agree on anything, say "purpose" is an important ingredient. The child must have a need for acquiring a skill. Learning is the by-product of the child's attempt to meet that need.

For young children, real learning depends on first-hand discovery and continuous experimentation, and the computer is patient teacher. I have found a number of programs and games that develop a variety of skills in children of different ages.

Some of these are drill programs. They make fact-learning fun, and the child can work alone. Ones I have found valuable are Kaypro Educational Programming's *States and Capitals*, *Spell*, and *Animal*; and IFP Publishing's *Kid.Math*.

In *States and Capitals*, the computer names a state. If the child responds by typing the correctly spelled capital, encouraging words are given. Wrong answers, including misspellings, are computer corrected.

My ten-year-old had success with *Spell*. She found learning 25 spelling words each week difficult. The problem, common among children, was that she saw words as blocks of letters rather than as a specific sequence of them—she couldn't see the trees for the forest. We entered her spelling list into the computer each week. Each word was flashed onscreen, and after it disappeared, she entered the spelling. She was forced to concentrate on the individual letters through typing. At the end of the list, missed words were reviewed.

(My daughter is an A+ speller now and no longer uses the drill. Why? Once children successfully satisfy a need, they are more likely to repeat the response when a similar problem is presented. She needed better study skills. When they were acquired, she used them to learn subsequent lists.)

In *Animal*, the child is told to think of an animal. Then a question appears. "Is it a mammal?" If the child doesn't know what a mammal is, a parent can encourage use of a dictionary. The questioning continues using such words as feline, aquatic, and nocturnal; the child should look up each unfamiliar word.

If the computer can't "guess" the animal, the child must think of a characteristic that makes it different from the one the computer screened last. The computer progressively "learns" new animals. As it becomes harder to stump, the kids search the dictionary for the odd and unusual. This game has "hooked" my children on words.

Kid.Math has counting and number recognition games that delight my two-year-old. He can enter a number and have the computer "beep" it out while he counts along. In his favorite game, five numbers are printed in large-size graphics. Four numbers are the same; one is different. He identifies the different one. If he does not guess the number after three tries, the correct answer is given and the same five numbers are

screened again. The game won't progress until the child enters the correct response. The score flashes after each correct answer and displays a big "YOU WIN" at the end of the game.

While drill software is useful to an extent, once a child learns a skill, practice is often avoided. The true educational strength of the Kaypro, I believe, lies in the games written for it. Most include lengthy directions the child must comprehend in order to play. This establishes a personal need to gather information for later use.

There are several types of games I feel are good learning tools. Games like *Adventure* top the list. The child is presented with a goal such as finding a treasure. He directs the computer using one- or two-word commands to navigate the course, deal with unexpected situations, and retrieve the booty. Logic, memory, and mapping skills are important in these games. The child must make inferences and draw conclusions, and these games also help children visualize cause-and-effect relationships.

Several board games are included in Kaypro's software bundle, such as chess, checkers, and *Go-Bang*, in which the player matches his strategy skills against the computer's. Player moves are made by entering coordinates on a grid. Coordinate plotting is frequently a part of the child's math training.

Older kids like the space games (*StarTrek*, *Trade*, and *Rocket*) that involve coordinate plotting, using percentages, and calculating acceleration and fuel consumption rates and management games, such as *Civil War* and *Kingdom*, that require players to efficiently manage resources, land, people, and money. I feel game playing is necessary to maintain interest in computing, but of course there are other ways to use computers to teach skills.

Most language skills, for example, are best taught through composition, but many students hate to write because good writing requires editing, and editing requires recopying. This loop is viewed as punishment, since the more one writes the more one recopies. Word processing is easier, and as a result, kids tend to revise more and produce longer, more detailed compositions.

No matter how computers are brought into the learning process, children learn more when parents are interested in and encourage their endeavors. Learning to operate a computer is no different.

Teach your children equipment use and care. When they use drill software, encourage them and praise their progress. Help them understand game directions and vocabulary, and offer advice and strategies.

In the final analysis, even if your machine does nothing more than give you and your children quality time together, it's worth every dollar you paid for it. □

Linda McPherson is a mother, teacher, and writer.



Acing the SAT

Getting the competitive edge with practice

by Benson Wong, with Mary DeDanan

The worst thing that can happen to you when you take your SAT test is that your hands will be so sweaty that your pencil will fly out of your grip and land four feet away. When you go to retrieve it, the proctor will accuse you of looking at the crib notes on some guy's ankle.

I take it back. The worst thing that can happen is that your mind will become softer than white bread, and just as empty. You will look at the following question, "If bee is to butterfly as chair is to floor, then is 5 bigger than Q?" and the only thing you will be able to recall is last year's baseball stats.

Wait, wait, here it is. The worst thing that can happen during your SAT: you will look at the quantitative comparison section of the math test and feel sick. Really sick. Really, honestly, truly sick. The proctor will not believe you. He will accuse you of wanting to check the crib notes on your *own* ankle. If he doesn't let you go to the bathroom, you may die from a lethal dose of embarrassment.

Of course, there is another scenario. Picture this: you saunter into the testing room. You listen to the proctor's instructions politely, but calmly. You know the rules. The proctor brandishes his stop watch and shouts "Begin!" With a wink to that attractive person in green sitting next to you, you open the booklet.

"The word most nearly opposite in meaning to *agreeable* is a) plutonomy, b) albatross, c) premolar, or d) autochthon."

You, of course, will know immediately that the correct answer is b) albatross. That's because you practiced taking the SAT long before the test date. And practice, as we all know, makes the difference between perfect and panic city.

Practice is just what you get with a couple of Kaypro-compatible SAT preparation programs, one made by Krell Software Corporation in Stony Brook, New York, and another made by Resource Software International Incorporated (RSI) in Fords, New Jersey.

The Krell package costs considerably more than RSI's program, and the manufacturer acknowledges that it's the most expensive on the market. There are a

couple of good reasons for this, Krell maintains: one is the warranty and bonus for improved scores; the other is Krell's "randomization feature." The RSI program offers just 18 questions per section. On the other hand, it has certain features the Krell package lacks.

But before I talk about the advantages and drawbacks of these two packages allow me to digress just a little and speak about the SAT itself.

SAT spells terror

Is there a single college-bound kid in the country who does not live in terror of the Scholastic Aptitude Test? I was recently a high school student myself, and although I took the test two years ago, I clearly remember the anxiety. Why? Because SATs are used in the admissions process for universities across the nation. Your score may well determine whether you get into Harvard . . . or are condemned to Podunk Junction Dairyman's School. For those innocents who are not yet aware of what they're in for, here's the scoop:

The SAT tests a student's math and language skills. There are four verbal sections, two math sections, and a written English section.

The verbal part of the SAT focuses on vocabulary and comprehension. It can be devious. For instance, in the first vocabulary segment, each question asks for the word that is most nearly *opposite* in meaning to the word given. In the analogies section, you are required to find a relationship between two words, then find a similar relationship in the answer choices. (I consider it the hardest part of the whole test.)

Comprehension is up next. First you must complete sentences from which one or two words are missing. A large vocabulary will also come in handy here, since the choices of missing words are tricky. Last is reading comprehension, where you read a passage of text and then answer slippery questions about it.

The math section is a double header: standard multiple-choice questions and quantitative comparison questions. On multiple-choice, you must figure out the problem, then hope that your answer matches one of the choices below it.

The quantitative comparison questions show two values, "A" and "B." You must find which value is larger, or whether they are equal, or whether the answer can be determined at all. This part of the math test is a considered a little harder.

The Test of Standard Written English (TSWE) examines your grammar skills. The challenge here is determining which phrase is correct or incorrect. It should be noted that this test is graded separately from the verbal and math sections, and serves mainly as a placement device for the college.

A perfect score on the entire SAT is 1600. One right answer gives you one point. A question left blank gives no points. An incorrect answer subtracts a quarter of a point (or one-third of a point for some math questions). This method of docking is to discourage you from playing eeny-meeny-miney-moe with your answers.

If I know you, you'll want to come as close to the magic 1600 as you can. So bring in your Kaypro and let's talk SAT preparation software. Both the Krell and RSI packages are excellent in content and cover the subject matter very thoroughly. Both work by drilling you in the exact types of questions that you will be facing on the real test. Both have a few minor problems, but overall, the pluses outweigh the minuses.

Krell's College Board SAT Preparation Series

Getting the Krell software to run first requires that you put BASIC on each of the four diskettes. The program comes with a detailed instruction sheet, so even someone who has never before used a computer can do it. Once BASIC is on, you complete loading by pressing the reset button. All this makes it extremely easy to get going with Krell. In fact, my friends (who co-tested with me) found this program easier to load than the RSI package.

Is there a single college-bound kid who doesn't live in terror of the SAT?

One stand-out feature of the Krell's package is that you can choose the number of questions you wish to answer. This makes it very flexible because, unlike the RSI program, it allows up to 1,000 questions. You can also ask for questions based on your previous "learning coefficient." In other words, Krell will check the lessons you have done and determine the problems you need to work on. Krell refers to this as the Automatic Learning Feature.

Another advantage of this package is that the scoring is very similar to the actual SAT. It also shows your score after each question, so that you can see how you are doing. The questions in this package are hard, but

so is the SAT. It's definitely better to get used to it now.

Now here's a nice feature: Krell offers a bonus of \$15 if your SAT score is increased by 75 points, or if you score over 1350. There is also a limited warranty that this program will increase your score by 50 points or you get your money back.

There are a few flaws in this program that you might want to know before you shell out everything you saved from your summer job at McDonald's. For instance, the Krell program does not show you the question at the same time that it reveals the answer. It's possible to forget what the question was!

Same thing on the vocabulary part—Krell offers no definition of the word. After the word is gone, you still may have no idea of its meaning. However, on the math section, Krell will show you the solution, then ask if you want another problem of this type. This is an advantage because you can keep working on the tough ones until you get them right.

There is a slight logistics problem with Krell's reading comprehension section and some of the math questions. You must look back into the instruction manual where the text passages and mathematical diagrams are located. This may be a hassle, since it requires that you keep the manual next to you. But at least this eliminates the headache of not having the questions with the answers.

But don't let these few bugs discourage you. Overall, Krell has a terrific study program.

Resource Software International: The Coach

Another SAT program is "The Coach," sold by Resource Software International. Unfortunately, loading it could be challenging for some. First you must place a diskette with BASIC in drive A and the RSI diskette in B. If you try to reverse the process, the drive will just spin freely as if nothing is in there. After logging onto drive B, you must then type "A:MBASIC CAI96" (since the program is in BASIC and the menu program is CAI96). However, once it gets started, RSI is very easy to use.

RSI starts with the math section. There is a chance for you to review information about triangles, circles, and squares. At any time during the sample test the equations needed for area, perimeter, and angles can be shown and readily used. Solutions are flashed alongside the questions, so that you can see what is going on. The program also displays some diagrams, to let you visualize the questions as well as read them. The diagrams are not high-resolution, but they do get to the point. (The Krell program contained no diagrams.)

In the math section, you can ask for help on any sticky problems. Even if you get it wrong, RSI will give you good hints. And if you choose a wrong answer, you get to try again. In fact, you can keep trying until there is only one choice left. At that time RSI will sigh a little computer sigh and just give you the answer, since it's pretty obvious what it is anyway.

The verbal part of the test is just as good. I especially

liked the reading comprehension section. The passage you must analyze is on the screen rather than in a separate booklet. And while answering the questions, it is possible to look back at the text—a real advantage.

I also preferred this program's explanations of antonyms. RSI shows the definition of the word in question, as well as the definitions of all the other words. The analogies explanations are equally good. RSI interprets the relationship between the two words,

At the end of the practice tests, RSI gives the percentage and number correct.

then reveals similar relationships among other word pairs.

At the end of the RSI practice tests (both verbal and mathematical), the program gives you your score by the percentage and number correct on the first try, percentage and number correct on the second try, on the third try, and so on. Also, at the end, it is possible to retake the questions you got wrong. Of course, the disadvantage here is that you already know the answers.

Regrettably, there are other disadvantages in this program as well. Some of the questions in the grammar part (for the TSWE) are not very good and therefore hard to understand. Also, the analogy section is a little too easy compared to the actual SAT and may not be adequate preparation.

Perhaps the biggest problem is that this program has a very limited number of problems to answer. Each quiz has only 18 questions. If you want more, you're out of luck because you are also out of questions.

RSI does not offer any warranty or gift certificate for improved scores, but this should not be a reason to pass this program by. Your reduced test anxiety will be reward enough.

Conclusions

Both programs are excellent for their respective prices since both can help the willing student prepare for the SAT and similar exams. The Krell package costs considerably more (\$229.95 versus \$34.95), but offers much more. Its randomization feature makes many more questions possible, and provides far more rigorous practice overall. Moreover, Krell offers a \$15 bonus if you do well on the real SAT, and your money back if you don't.

For the budget-minded, the \$34.95 price of RSI's program is certainly right. The program offers helpful onscreen diagrams, hints, and other help. And, overall, it offers good practice. But once you've covered the 18 to

(continued on page 74)

ENHANCE WordStar

with

P-r-o-p-o-r-t-i-o-n-a-l Spacing on WordStar

You are reading text printed by WordStar in **proportional spacing**, providing a professional, easy to read, typeset appearance, direct from the print command on any version of WordStar. Also print two or more columns on a page, **underline spaces between words**, and much more. Works with most letter quality printers (Diablo, Qume, NEC, Juki, Brother, C. Itoh, Silver Reed, others).

"The best and least expensive method of dramatically improving the appearance of any WordStar text" - LIST

We let you edit and print at the same time! ProportionalStar (CP/M, MS/PC-DOS) *automatically* modifies WordStar. \$75, including manual. Manual only (100 pages - with full details for implementing PS using Install) \$22.50. No technical skill is needed. Text can be right justified. Printer does *not* require PS logic. Add \$2.50 shipping per order. NYS add tax.

Okay! My check is enclosed for \$ _____ (or charge my VISA/MC acct # _____ exp ____/____).

Writing Consultants

Suite 104, 11 Creek Bend Drive • Fairport, NY 14450
1-800-828-6293 (in NYS 1-716-377-0130)
phones open 24 hours • dealers please call or write

SPACE SAVERS

An all New Hi-Tec design of tough, durable acrylic, specially for Kaypro® models. A great gift idea for the coming holidays. 15 day - Moneyback Guarantee.

NEW



Computer Stand

\$39⁹⁵

Angled for easy viewing of the monitor. Keyboard slides underneath for storage. Back is open for good ventilation.



\$95

All-In-One Computer & Printer Stand

Printer Stands

Angled so type can be seen while printing.

Large Model
20"x14" - 6" high

\$39⁹⁵

Small Model
15"x14" - 6" high

\$29⁹⁵

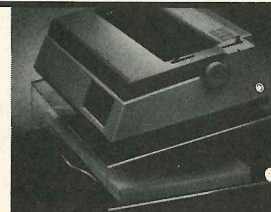

Order in clear acrylic or add \$5 for smoke acrylic. 10" or 15" slot in the Computer & Printer Stand for Center Feed Printer add \$2.

Ohio Plastic & Safety Products, Inc. (216) 882-6764
6140 Manchester Road Akron, Ohio 44319
Check, Money Order, VISA, or C.O.D. + \$5 shipping.

"NEXT TO MY SOFTWARE, NOTHING'S MORE USER FRIENDLY THAN THE WALL STREET JOURNAL."

WILLIAM H. GATES III, CHAIRMAN, MICROSOFT CORPORATION

If you really want to know how valuable good business information can be, ask somebody who makes his living in the information business. Bill Gates, for example:

A TON OF INFORMATION

"I need a ton of information to stay the leader in computer software, but I have super-limited time. Which is precisely why I read The Wall Street Journal.

"My company's part of an industry that's moving very fast. The Journal does a great job of keeping up with it. Their coverage of the whole computer area is extremely good."

IN PRACTICALLY NO TIME

"And the way The Journal's organized, I can access this information in practically no time. A quick scan of 'What's News' on the front page tells me what stories I should read. And the stories give you the most news in the fewest words.

"They also give you a fresh perspective. I like to read how non-industry people see and react to what's going on in my industry. It gives me a much better feel for the marketplace I'm competing in."

IF IT'S IMPORTANT, IT'S IN THE JOURNAL

"There are some things I don't have any way of finding out except by reading The Journal. Like which big companies are committing to what hardware. Information so



important it influences the way we deal with our customers today and plan marketing strategies for tomorrow.

"Why, even when there's no news about my industry in The Journal, that's important news.

It means I have a lot less to worry about."

Bill Gates knows that every Monday through Friday, The Journal has all the business news you need, fresh, concise and ready to use.

Plus lively looks at leisure and the arts, provocative editorials and political insights.

That's why he's a Journal subscriber.

Shouldn't you be one, too?

HOW TO SUBSCRIBE

To have The Wall Street Journal rushed to you every business day for 26 weeks for only \$56—and save \$7.50 off the cover price—mail the coupon below. Do it now.

THE WALL STREET JOURNAL
Attn: Manager of Subscriber Service
200 Burnett Road, Chicopee, MA 01021

- Send me six months of The Journal for \$56.
 I prefer one year for \$107. Bill me
 Check enclosed. Please charge my Diners Club
 American Express MC VISA

Card# _____ Exp. _____

Signature _____

Name (Please print) _____

Address _____

City _____ State/Zip _____

Limited time offer—good in Continental U.S. only. 2MAF

THE WALL STREET JOURNAL.
All the business news you need. When you need it.

Just Got Your KayPro?

We'd like to introduce you to the leading workstation available today.

Porta-Micro Mate

A Modern Workstation With These Modern Advantages

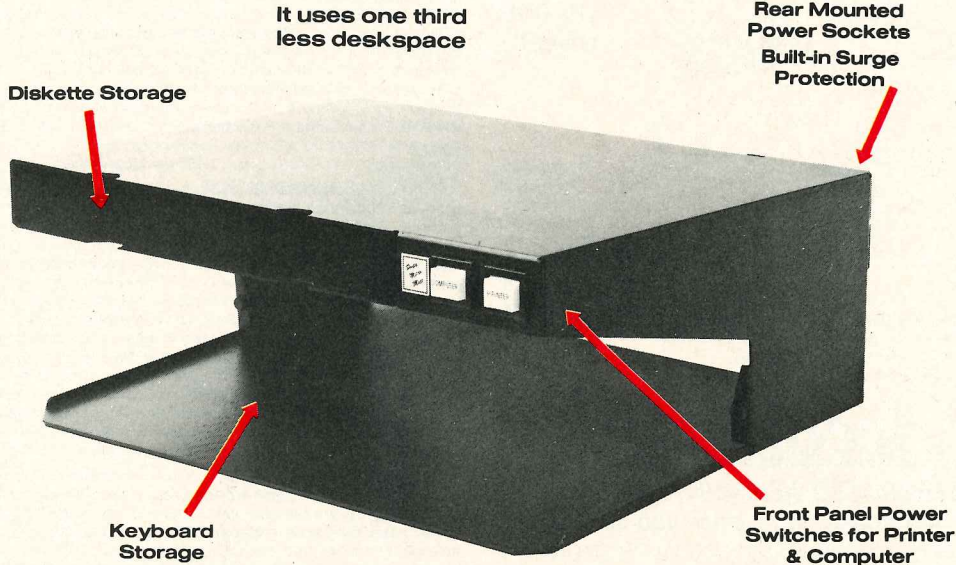

It uses one third less desk space

Rear Mounted Power Sockets
Built-in Surge Protection

Diskette Storage

Keyboard Storage

Front Panel Power Switches for Printer & Computer

Two Models To Choose From:

Stationary Model \$99.95
Swivel Base Model \$119.95

SOS

MARKETING

362 S. La Brea Avenue
Los Angeles, CA 90036
(213) 857-0371

DEALER INQUIRIES
INVITED



SIZZLING SUMMER COVER-UP

Buy a Porta-Micro Mate from any authorized dealer and send in your warranty card with a copy of your sales receipt and \$1.50 for handling and you will receive a FREE Computer Dust Cover
Allow 4 to 6 Weeks For Delivery
(Offer Expires August 31, 1985)



DATASAVER[®]

Reliable Microcomputer Power

- PROTECTION** - saves data during power failures.
- saves hardware from overvoltage transients.
- PORTABILITY** - allows mobile or extended holdup time using auxiliary 12 volt battery.
- FEATURES** - internal battery provides 5 min. + operating time — AC line conditioning — audible and visual alarms, interrupt signal — no installation required.

200 Watt - \$495
90 Watt - \$350

Special applications, OEM/Dealers call (805) 541-4160

Instant Power Order Line
805-541-4161



CUESTA SYSTEMS, INC.
3440 Roberto Court
San Luis Obispo, CA 93401

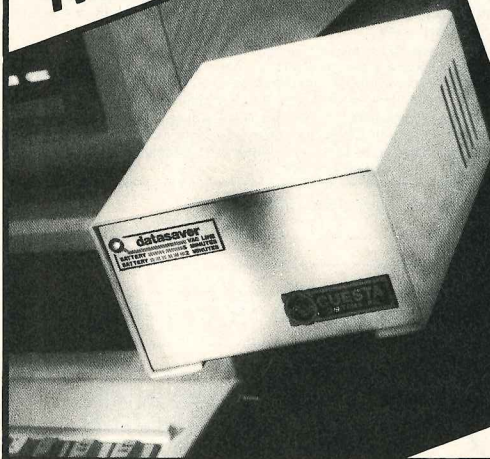

AVAILABLE FOR
KAYPRO 16, 286i and
the new KAYPRO 2000

ACCOUNTING SOFTWARE

for Portable, Personal and Desktop Computers

Available for popular 8-bit and 16-bit microcomputer formats:

NOW
NEARLY
10,000
USERS

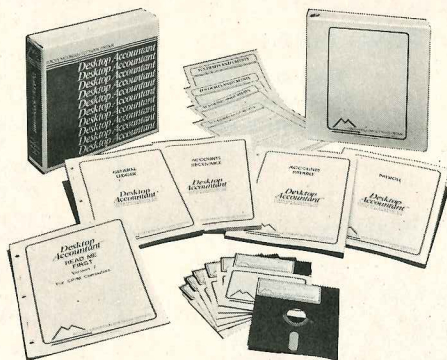

This time-tested, interactive software was originally developed in 1975 for small-to-medium sized businesses. Since then it has successfully proven itself in well over 10,000 companies in all 50 states and in 13 foreign countries. It is used by hundreds of bookkeepers, accountants and CPAs. Order yours today.

"...for several years the de facto standard for microcomputer software, and still a good example of some of the better thought-out software on the market." —Interface Age

Complete
Package of
Software,
Training Aids,
Manuals, and
Users' Newsletter

ONLY
\$395

Telephone
Support \$100

Desktop Accountant™

FULL-FEATURE, FULLY-INTEGRATED ACCOUNTING SYSTEM

Everything you need to keep the books... at a price you can afford!
Your Bookkeeper, Accountant, and Banker will love you for installing this fine system!

Check these features:

This remarkably-valued Accounting System will manage your company's business records and automate your entire bookkeeping process—from the posting of individual transactions to producing up-to-the-minute Income Statements, Balance Sheets, and other important management reports. Desktop Accountant™ gives you a "Big Company," professional image with pre-printed invoices, statements, and checks. It is user-friendly, completely menu-driven, offers system-prompted data entry, and is compatible with both floppy and hard disks. Feature-for-feature, and dollar-for-dollar it is the best software value on the market! But don't let the low price fool you. Desktop Accountant™ is not a "cheap" accounting system, only inexpensive. That's because original development costs were recovered years ago allowing us to sell an excellent product in high volume at low prices and still earn a fair profit. Included with your system are complete source code in MBASIC and

a FREE calendar year subscription to our user's newsletter "Debits and Credits" plus access to our optional telephone "Hot Line" support service and our growing network of Experienced User Consultants™. No other Accounting System at this price offers you so many features, benefits, and valuable extra services. You can pay more but you can't buy more! Call for free literature or order now with complete confidence.

Read what Users say...

"Two hours after receiving the Desktop Accountant I was up and running live data, and generated an entire month's work and financial statements the following day."

—J.C. Bartels, President
(accounting firm) Gonzales, Texas

"To get anything better we would have had to spend multiple thousands of dollars. I think it's a dynamite package for the money."

—Bob Cox, V.P. General Mgr.
(manufacturing company) San Antonio, Texas

LETTERS/ON FILE

Other members of the Desktop Family:

For Lawyers, CPAs, other professionals...

Desktop Time & Billing™

Professional Time Billing & Management System

Desktop Time & Billing simplifies the billing process, prompts professionals to bill on time, reduces unbilled work-in-process, measures and analyzes non-chargeable time, minimizes unreported time, provides objective criteria to analyze staff performance, and reduces manual and clerical effort. Integrates with Desktop G/L. User defined billing format. Only \$495. Not available in every format.

Desktop Inventory Manager™

Comprehensive stand-alone Inventory Management System for retail and wholesale businesses • Multi-location/multi-department applications • Quantity capacity to 999,999,999.999 • Fractional units • Inquiry function uses partial item keys • Many reports printed by department, location, or vendor and can include entire data file or any subset • Produces 11 management reports • Tracks sales, receipts, returns and reserves • Optional history records • Part Numbers can be any printable character • Complete audit trail • PRICE: \$295 • Not available in every format.

Call for FREE LITERATURE, including sample reports • Available from your local dealer or directly from us • Order today by Mail or Phone • Phone Orders Filled Promptly

Orders, Questions, and Literature Requests CALL NOW, TOLL-FREE



1-800-832-2244
In California call 1-800-732-2311

Please mention
Ad #1304

Send Orders To: 1280-C Newell Avenue, Suite 1304, Walnut Creek, California 94596
• When ordering please mention or include the Ad number appearing near our telephone number • Orders shipped within 48 hours via UPS • Add \$5.00 for faster 2-day Rush Air Service • California residents add 6 1/2% Sales Tax • Payment by VISA/MasterCard/COD/IM/Cashier's Check • All Brand Names are manufacturers' registered Trade Marks • Dealer inquiries invited • Specifications subject to change without notice • Foreign orders please call or write before ordering ©1983 Rocky Mountain Software Systems.

A Complete System!

includes all four standard general accounting programs:

GENERAL LEDGER is completely integrated to automatically post end-of-month transactions from A/R, A/P and Payroll. It prints 13 detailed reports for the entire company, and optional Income Statements for up to 99 departments. It produces up-to-the-minute comparative financial statements with current, year-to-date, budget, and last year (month and YTD), showing both dollar amounts and percentages, and presents everything you, your bookkeeper, and your accountant need to know about the company • G/L automatically reconciles all accounts, and maintains extensive, detailed audit trails showing the source of each G/L entry for quick, easy, tracing • Trial Balance includes all transactions • Flexible Chart of Accounts • True double-entry bookkeeping • Master File capacity: 400 Accounts • Monthly Transactions capacity: 1,000 with 200K diskette; 3,500 with 500K diskette; 7,000 per Megabyte with a Hard Disk.

ACCOUNTS RECEIVABLE provides instant, on-line customer account information (both current and aged), with complete, timely invoicing, including open-item (or balance forward) and statement capabilities. It makes the entire billing process fast, easy, and efficient. It quickly identifies your overdue accounts, helps speed collections, helps control your cash flow, and assists you in making better financial decisions. Both detailed and summary customer activity and aging reports are instantly available • Preprinted forms available for invoices and statements • Optional service type invoice • Automatic finance charge calculation • Detailed audit trail • Maintains comprehensive customer data files • Produces 8 reports and documents • Includes automatic periodic customer/client billing option which is ideal for service businesses • Itemized monthly statements • Master File capacity: 400 Customers • Monthly Transactions capacity: 800 with 200K diskette; 3,500 with 500K diskette; 7,000 per Megabyte with a Hard Disk.

ACCOUNTS PAYABLE maintains complete vendor/voucher history and includes check-writing capabilities. Current and aged payable reports are available upon command. It prepares an extremely useful cash flow/cash requirements report that greatly improves management control of your most valuable resource—cash! It prints checks (on commercially available forms on which your company name, address and logo can be imprinted) with comprehensive check stubs that your vendors will appreciate • Produces 11 reports and documents • Automatic pay selection program allows payment by due date or by discount date • Manual and automatic checkwriting • Check register • Detailed audit trail • Itemized monthly transactions • Master File capacity: 400 Vendors • Monthly Transactions capacity: 800 with 200K diskette; 3,500 with 500K diskette; 7,000 per Megabyte with a Hard Disk.

PAYROLL is a complete, easy-to-use professional-quality payroll system. Be the office hero each week when the checks come out on time! This program calculates payroll for every type of employee (hourly, salaried, and commissioned) and prints payroll checks (with popular, comprehensive check stubs) with an absolute minimum of input. Your company name and logo can appear on these, too. • Stores and reports comprehensive employee and payroll information. • Maintains monthly, quarterly, and yearly totals for reporting purposes in multiple states(!) • Offers user-maintainable Federal, State, and local tax tables(!) • W-2 printing • 941 Reporting • Produces 10 reports and documents • Master File capacity: 400 employees. An outstanding Payroll package!

Produces These Reports & Documents:

General Ledger 1. Chart of Accounts 2. Chart of Accounts with summary dollar amounts 3. Chart of Accounts with prior year comparisons 4. Daily Transactions Report 5. Itemized Monthly Transactions 6. Balance Sheet 7. Balance Sheet with prior year comparison 8. Income Statement 9. Income Statement with prior year comparison 10. Departmental Income Statement(s) 11. Departmental Income Statement(s) with prior year comparison 12. Detail report for individual accounts 13. Trial Balance Statement

Accounts Receivable 1. Daily Transactions Report 2. Invoices (with or without preprinted forms) 3. Statements (with or without pre-printed forms) 4. Summary Aging Report 5. Detailed Aging Report 6. Itemized Monthly Transactions 7. Detailed Customer Activity Report 8. Summary Customer Account Report 9. Customer Mailing Labels

Accounts Payable 1. Daily Voucher Report 2. Daily Credit Report 3. Checks with Detailed stubs 4. Check Register 5. General Ledger Transfer Report 6. Cash Requirements Report 7. Transaction Register 8. Open Voucher Report 9. Aged Payables Report 10. Detailed Vendor Activity Report 11. Summary Vendor Account Report 12. Vendor Mailing Labels

Payroll 1. Federal Tax Tables 2. State Tax Tables 3. Payroll checks with stubs 4. Payroll Check Register 5. Monthly Payroll Summary 6. Quarterly Payroll Summary 7. General Ledger Transfer Report 8. Detailed Employee File Listing 9. Produces 941 Worksheet 10. Prints annual W-2 Forms 11. Employee Mailing Labels

System Requirements: CP/M® with 64K RAM or PC-DOS (MS-DOS) with 128K • Microsoft BASIC • Two disk drives or hard disk • 132 column wide carriage printer, or an 8 1/2" x 11" printer with compressed print mode (an Epson MX-80 or similar printer).

Rush me more information on Desktop!!

Name _____
Company _____
Address _____
City _____ State _____ Zip _____
Phone _____
Computer System _____



ROCKY MOUNTAIN
SOFTWARE SYSTEMS
Specialists in Accounting Software

1280-C Newell Avenue, Suite 1304, Walnut Creek, California 94596

WELCOME
TO THE
KAYPRO
GENERAL STORE



... Especially for you

Just for Kuggers ...



Coffee Cups

Brighten your mornings with this Kaypro coffee cup, made of English Ironstone. Your morning coffee will taste better in this sturdy cup, displaying an attractively repeated Kaypro logo design. Available in black on white or white on black.

Business Card File

How many times have you lost that important business card? Get organized with the new Kaypro Business Card holder. It features a foil Kaypro logo on outside cover and holds up to 96 business cards in easy view for quick reference. It's an ideal complement to the matching executive meeting folder.

Meeting Folder

Breeze through the workday with Kaypro's "Executor" deluxe meeting folder. Metal corners and turned edge stitched construction. Silver foil Kaypro logo on right front cover and inside. Complete with letter sized writing pad and pen loop.

... meetings anyone?

If the Shirt Fits ...



The Famous Kaypro Baseball Hat

Batter's up! It's always baseball season with Kaypro. This jaunty white baseball hat sports the Kaypro logo in a two color "puff print." Adjustable strap—one size fits all.

Kaypro White T-Shirt

Kaypro's T-Shirt is Terrific! It's Hanes Beefy-T heavy-weight cotton pocketed T-Shirt, white only with a two color design on back, one color front imprint. Available in SM, MED, LG, and EX-LG. Be sure to specify size when ordering.

Golf Shirts

Look your best whether you're shooting 18 or serving 30-Love. A major purchase by Kaypro brings you these high quality Hanes 50-50 cotton/polyester sportshirts with knit collar and hemmed sleeve. Kaypro logo on front in dark blue. Specify yellow or light blue, and size (SM, MED, LG, and EX-LG).

... it must be Kaypro!

Fun Goods ...

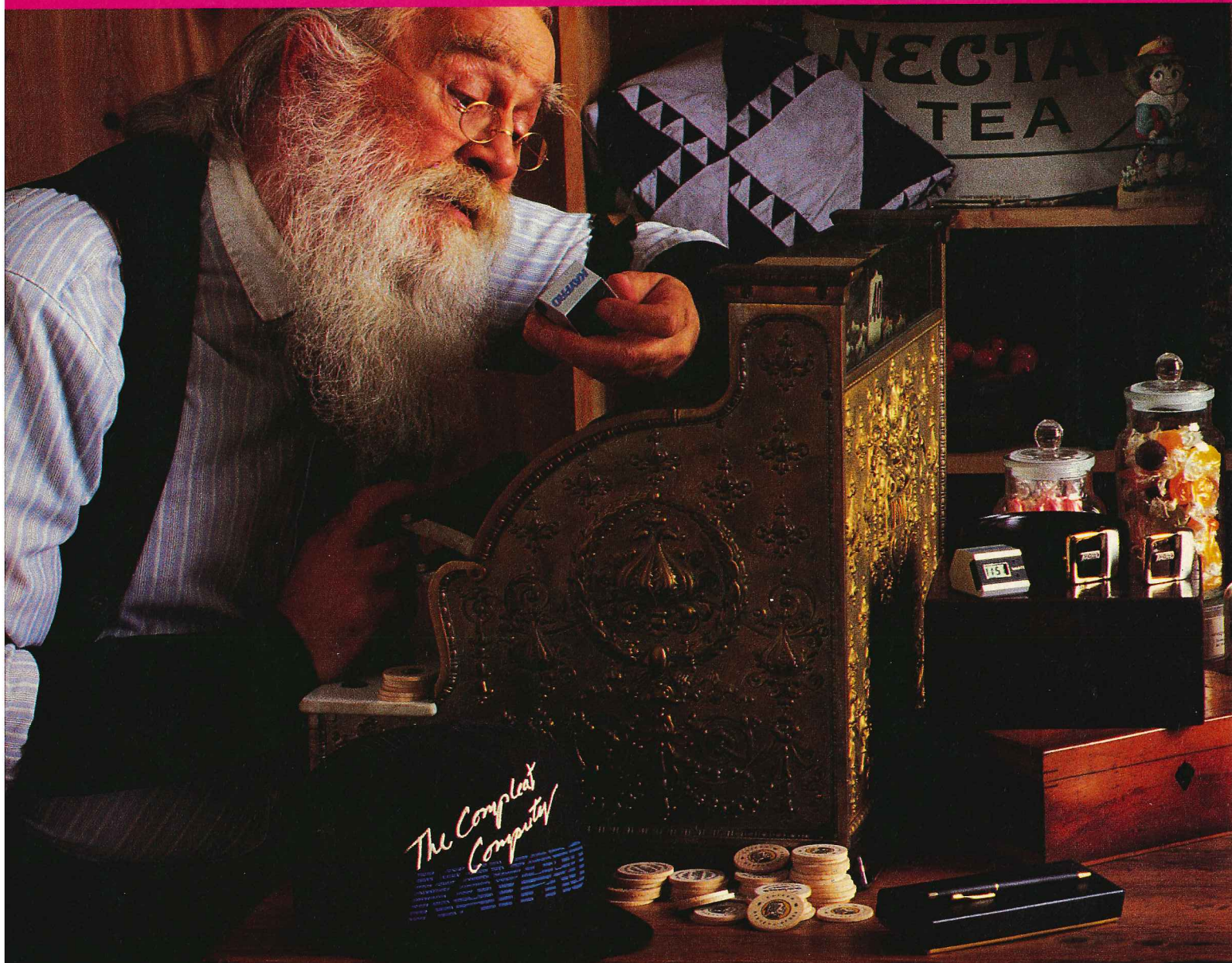

The Famous Kaypro Baseball Hat

Batter's up! It's always baseball season with Kaypro. This jaunty black baseball hat sports the Kaypro logo in a two color "puff print." Adjustable strap—one size fits all.

Desk Clock/ Paperweight

Hey, what time is it? Find out in a flash with this silver anodized digital desk clock. Need the date and need it quick? Check the Kaypro clock's alternating day/ date readout. Give it to your mother, your mother-in-law or just keep it yourself.

Executive Kaypro Corporate Belt

Buckle up with the Kaypro executive belt. Featuring a polished custom buckle, die cast with a Kaypro logo center bar, the belt's reversible to complement any outfit. Cut to fit.

... for the whole family.

Team/Kaypro Jacket ...



Crystal Tumblers

Serve drinks in style with these executive crystal tumblers. Each glass holds eleven ounces, and includes a satin etched Kaypro logo. It's a set of four, available in clear only.

A.T. Cross Pen

It's a Kaypro classic. The ultimate in quality writing instruments, the famous A.T. Cross pen comes in black or 10k gold-filled, with a discreet Kaypro logo. You'll receive a handsome box and the Cross lifetime guarantee.

Black Satin Jacket

Show your colors! The height of casual chic is Kaypro's popular black satin jacket. Elegantly embroidered with the Kaypro logo on front and back, the jacket has nylon lining and knit cuffs, collar and waist. Front snap. Available in SM, MED, LG and EX-LG.

... for that racy look.

For Your Desk ...

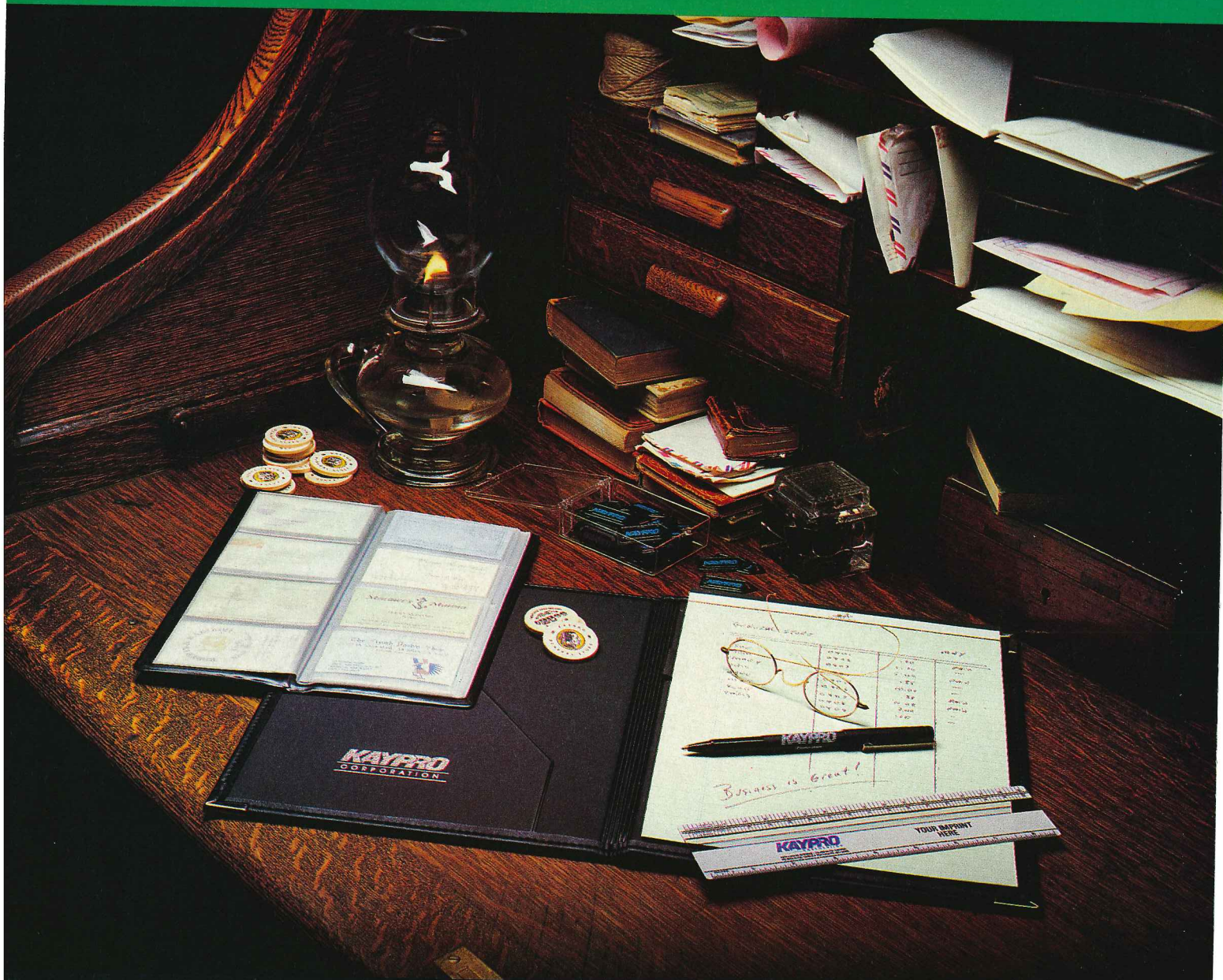

Paper Clips

It's always fun to send a message in a clip and these are perfect! It's a black plastic paper clip imprinted with the Kaypro logo and comes 50 to a box. Available in bulk (3000 @ \$45.00) on special order.

The Kaypro Uniball Pen

A real favorite with everyone has been this Uniball Pen. Not too expensive but it sure goes a long way in Kaypro style.

Kaypro Printer Ruler

Calculate your printer spacing for special applications with this nifty little ruler. This popular time saver is available with the Kaypro logo only.

... or for the boss.

It's Keys to Kalculation ...



Custom Key Fobs

Handsome die struck and color filled medallion on a top grain black leather fob. Unbreakable, large capacity split ring—top of the line. Available in the Kaypro 2000 or the Kaypro 286i designs.

Ultra Thin Calculator

Credit card size! This calculator runs on any available light source, and never needs batteries. Imprinted with the Kaypro logo, it includes a vinyl case and programming instructions.

... and your car.

The Kaypro Executive ...



Neckties

A luxurious polysilk blend necktie with a subtle, woven-in silk threaded Kaypro logo design. Current fashion proportions. Wool lined, this tie is available in two classic color combinations, blue and burgundy.

Kaypro Tie Bar

Show 'em who's who. Wear this die struck silverstone highlighted Tie Bar. A great gift for the true blue Kaypro user.

Executive Kaypro Corporate Belt

Buckle up with the Kaypro executive belt. Featuring a polished custom buckle, die cast with a Kaypro logo center bar, the belt's reversible to complement any outfit. Cut to fit.

... a step ahead.

C.P.I. BUSINESS SYSTEMS

Our software saves you money before it's installed

Computer Professionals, Inc. has been developing computer applications for business and industry for NINETEEN years, often working behind the scenes for some of the biggest names in the industry. We have learned how to pack a lot of power into each computer program but we know that raw power and ability is worth little unless coupled with ease of use, good documentation and responsive support. CPI's Business Systems are all these things and more. They run faster, support larger capacities and cost less than any similar systems marketed today. They have been installed by thousands of users (since 1978) and are available from us directly or from your KAYPRO dealer. We specialize in KAYPRO systems.

We know that floppy disk users don't appreciate shuffling four or five disks in and out per application. We know that no users like to abort in the middle of an application to change printer pitch. We know that users don't like copy protection and complex licensing agreements. We don't believe that any systems with these 'features' can be considered easy to use so we left them all out of CPI Business Systems.

Fancy packaging and expensive type set manuals add greatly to the cost of most application packages but have little lasting value. Once your system/s are up and running for a week or so their real worth is their day-to-day productivity and responsiveness; the other materials gather dust. CPI Business Systems include comprehensive manuals, sample data files, tutorial sessions, etc. - everything you need is included. Our manuals are prepared and printed on computer systems. We will provide them to you on disk (with an easy to use print program) which lets you make as many copies as you need, and pass the \$10.00 savings on to you or include them with each system. You decide - we work for you!

\$80.00 CP/M	GENERAL LEDGER	\$100.00 MS-DOS
-----------------	----------------	--------------------

Comprehensive system with the most wanted features. Provides accurate and well organized financial information for your business. Check the partial feature list below. Accepts data automatically from all other CPI Business Systems for completely integrated accounting. The entire program library fits on one 191K disk with room to spare. Menu driven for ease of use but the menus won't get in your way.

PROGRAM FUNCTIONS: Systems Initialization customizes programs for your business and hardware. - Master File Maintenance to create, modify and report on charts of accounts; auto Make Departments function speeds setup; lists charts in 3 formats, on 8 1/2" wide forms at 10cpi - Transaction (Journal Entry) Maintenance to enter and change and delete and post and list (3 formats); auto increment for reference from numeric pad; auto duplication of any field from prior entry, last 7 entries on display; source/run totals; validation of account numbers at time of entry; true prior period adjustments; repeating entries for depreciation, etc. - Trial Balance summary reports (2), worksheets and detail general ledgers; Full/Consolidated/Selective departmental (FCS) processing. - Financial Statements in 4 formats: current year, current and prior year, current quarterly, cumulative quarterly; FCS selection (see above); run any report for any prior period; indicate # of months for the current period even when re-running prior periods; disclaimers (two 78-char lines) for Accountants. - Budget Reporting with remaining or variance computations; current, YTD, both; rerun prior periods; FCS processing, variable # months in current period - Full Year Detail G/L high speed build up system; over 3,800 records on 191K disk; detail is shown in original input sequence by account; FCS; partial year reports when disk space is limited; auto buildup for hard disk users - End-Of-Period creates backup file automatically; updates repeating entry date fields for new month; selects month/year end processing automatically; updates prior year's data. - Accounting Transfer inputs data from each CPI Business System; posts; prints control reports; multiple transfers from other applications allowed. - Query Account - high speed displays to CRT or individual or range-of-account displays to printer. See the Hardware Requirements section also. All CPI systems include easy data entry and correction via formatted screens, Back-Up, Void & End keys.

CAPACITIES: CP/M - 600 Accounts; MS-DOS - 2000 Accounts - 3-5 Digits for Account Numbers - Up to 99 departments using 3-digit account number and 2-digit department number. Each K of disk can hold 8 records (i.e. 300+ accounts and 1200+ transactions on a 191K disk).

No system is perfect; CPI Business Systems are not exceptions. That's why users are entitled to support when they need it and that's why CPI continues to enhance each system regularly based on users suggestions.

Most users need a little support when getting started so we include 45 days of FREE support with each application. Others charge hundreds of dollars extra. Users of CPI Business Systems can extend support for a full year for less than ten cents per day per application.

CP/M users may become MS-DOS users in the years ahead; CPI has planned ahead for this possibility and we provide data file conversion service to any user. CPI will, however, continue to support and enhance these fine systems for CP/M users for years to come. Your investments today will not be obsoleted by tomorrow's technology.

These powerful systems are described briefly below. If you don't feel confident yet ask for our 30+ page overview or try an application demo system at half price (demo prices apply to future system orders).

There are no extra charges for shipping, COD, etc. American Express, MasterCard, VISA card orders welcome. We ship in 48 hours. Please tell us what format you want (II/2X/4/10/16), etc. Demo systems in KAYPRO formats only.

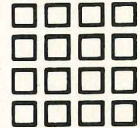

COMPUTER PROFESSIONALS, INC.
15 REGENCY HILLS DRIVE
GREENVILLE, S.C. 29607
Phone: (803) 268-3911



Personal/Company Checks OK

\$80.00 CP/M	ACCOUNTS PAYABLE	\$100.00 MS-DOS
-----------------	------------------	--------------------

Improve your cash management with this fine system. You'll get the up to date accurate picture of accounts to be paid, cash requirements for the data on file. Payments and notes vouchered automatically insuring timely payments. Complete check writing included. The system reports include Vendor File Lists, Open Vouchers, Ageing By Due Date, Discount Date Ageing, Cash Requirements, Check Registers, G/L Transaction List, Query Vendor Status, Credit Vouchers, Deleted Vouchers. CAPACITIES of 600 Vendors (CP/M), 2000 Vendors (MS-DOS) - no limit on transactions.

\$80.00 CP/M	ACCOUNTS RECEIVABLE	\$100.00 MS-DOS
-----------------	---------------------	--------------------

Super system with Invoices, Service Invoices, Statements, etc. A full range of reporting abilities include Customer Reports, Ageing Reports, Transactions Reports, G/L Transaction List, etc. Auto billing feature eliminates mistakes. Sales can be distributed to 100 accounts. Build up statement option combines the virtues of ledger card history detail and the speeds of todays computers. Use preprinted forms and/or plain paper for invoices and statements. CAPACITIES of 600 Customers (CP/M) 2000 (MS-DOS) - no limit on transactions, multiple customer disks OK.

\$80.00 CP/M	PAYROLL	\$100.00 MS-DOS
-----------------	---------	--------------------

A complete payroll system supplied with current tax routines for every state. Functions include Employee File Maintenance; Employee Lists in multiple levels of detail; Input Worksheets; Time Card Entry; Regular, Overtime, Other, Commissions, Tips, Misc. Pay, Exception Processing so you only enter variable data; Weekly, Bi-Weekly, Semi-Monthly, Monthly pay cycles (run individually/combined); Departmental Payrolls; Checks; Check Registers; Earnings Reports; 941's; W-2's; Unemployment Reports; Multi-state; Manual Checks; G/L Transactions. Federal, FICA, State and Local Taxes, Federal/State Add-Ons, FICA, FUTA, SUI, SDI, EIC, 4 other deductions. CAPACITIES - 600/2000 emp. (CP/M/MSDOS), 98 Tax File Rcds.

HARDWARE REQUIREMENTS

CP/M....: 64K (53K TPA) & CP/M 2.0 or higher.
MS-DOS..: 128K (or more) & MS-DOS/PC-DOS 2.0 or higher - ANSI.SYS.
Printer.: 132 columns (compressed pitch supported), continuous forms.
Disk/s...: Dual Floppies/Hard Disk/Both - 191K recommended, less works.
CRT.....: 80/24 with Clear, Home, Clear to EOL, Up, Down, Left, Right.

CURRENT UPDATE: WATCH FOR OUR NEWSLETTER WITH USAGE TIPS, UPDATES AVAILABLE, CUSTOM PROGRAMMING SERVICES AND MORE. JOIN OUR THOUSANDS OF SATISFIED USERS — ORDER DIRECT OR FROM YOUR DEALER AND PUT C.P.I. TO WORK FOR YOU TODAY.



The Ultimate Computer Speed-Up

Learn to touch type

by Sarah Wernick

Hunt-and-peck typing on a word processor makes about as much sense as driving down a super highway in a horse and buggy. If you never learned touch typing—or if you did, but want to polish your technique—let your Kaypro teach you with a typing instruction program.

The good news about typing instruction software is that it's relatively inexpensive. Two of the best packages reviewed below cost just \$30, and you can get so-so public domain programs that might suffice for your purposes virtually free. But the bad news is that none of the typing instruction software available for the Kaypro takes full advantage of the computer's potential.

Criteria

The secret of speedy, accurate typing is correct fingering—notwithstanding exceptions like my friend Roger, who fires off text at 70 words per minute using just his index fingers. It takes practice to master correct fingering. Lots of it. In mere minutes you can learn that your left pinky is responsible for the letters A, Q and Z. But only after hours of drill will your left pinky be able to type those letters automatically. Most of what you need from a typing teacher (human or electronic) isn't really instruction, it's well-planned practice.

Efficiency expert Frank Gilbreth, father of the "Cheaper by the Dozen" brood, taught his children to touch type by rapping their heads with a pencil when they made a mistake. None of the programs reviewed had this particular output device, but I weighted feedback mechanisms heavily in assessing the software.

Most of the programs begin with preliminary instruction, then present exercises with one to four typewritten lines for you to reproduce. I was looking for the equivalent of the descending pencil—a fast, clear indication of errors. Also, I wanted to know at the end of an exercise how fast and how accurately I had typed. A nice additional feature was on-disk record keeping to monitor progress. One major disappointment was that none of the programs could analyze errors and pinpoint keys or fingers that needed further practice.

There's no place for random strings of letters in

practice exercises. Beginning typists need letter groups carefully selected to reinforce proper fingering—for instance, juj juj to train the right index finger.

Intermediate exercises should use words rather than meaningless groups of letters, since extra practice is needed for the letter combinations typical of the English language. Advanced practice is best done on material that approximates what you will encounter in real-life typing. The more variety (in other words, the larger the base from which exercises are selected) the better. A few programs have simple provisions for inserting your own text, a big plus.

None of the programs covers everything on the Kaypro keyboard; most leave you on your own for the escape, control, delete, tilde, tab, backspace, backslash, bracket and cursor keys. Dvorak keyboard fans are totally neglected, though the programs could be adapted for this efficient system with effort.

I found no program that met all my criteria. But three were significantly better than the rest. First, descriptions of two also-rans.

EATYPE (Micro Cornucopia)

I've looked at about half a dozen public domain typing instruction programs. Most provide decent instruction, but limited drill and feedback. EATYPE is the best of the lot—which isn't saying much.

EATYPE is a version of TTYPE, a program that comes from Australia (where they spell what you're supposed to do "practise"). Micro Cornucopia gives the source for both versions, along with TTYPE's 19K documentation file. The packed disk also has TDRILL for rudimentary typing practice, plus two nifty but irrelevant programs: one lets you address an envelope without entering a word processor, and the other computes the "Fog Index"—a measure of the obscurity of your prose that's based on sentence and word length.

The program covers only the letter keys and basic punctuation. The documentation explains how to revise practice exercises—which is what you'll have to do if you want to work on numbers and symbols.

When you call up an exercise from the menu (with no

hint of what it contains, by the way), the screen provides instruction, a display of the keyboard and a one-line exercise to type. The tips are useful, but the keyboard display, which flashes distractingly, is not. The author (a self-admitted three-finger typist) wants you to turn off the echo that displays what you type, read your entry by following the flashing cursor—and at the same time do the exercise. No way.

If you wish, the machine will announce errors with a beep and keep the cursor in place until you get it right—a fine feature for beginners, I think. If you're willing to go through menus and wait a bit, it will count your errors and tell you how many words you typed per error—an offbeat measure. The author has left to the next generous programmer the task of interfacing EA-TYPE with a real-time clock to measure typing speed.

*Touch 'n' Go promises
you'll type 40 words
a minute with 95
percent accuracy.*

Given what's available for slightly more money, I don't think that this \$12 disk is a good value for someone who wants superior typing instruction. But if you'd like to probe the inner workings of a typing tutor program, tinker and improve, that's another story.

TYPE1 (Wildriver Software)

Like some public domain typing instruction programs, TYPE1 is written in Microsoft BASIC and requires the MBASIC interpreter to execute. Perhaps I'm prejudiced, but that seems unprofessional in software you pay \$25.50 for—like bringing your mother along on a job interview.

Calling up TYPE1 gets you a nine-item menu. The first order of business is to identify yourself, since the program wants to be on a first-name basis with you—annoyingly insists on it, in fact.

Options include instruction, assorted practice games and timed exercises. Instruction deals with just one finger at a time. Only in the games do you use different fingers in sequence, and only in the timed drills do you type real words.

Some of the games require that you search the screen for a flashing letter—a pointless task that could distract the beginner from using correct fingering. The timed tests present one line at a time; if you want to try again, you have to go through four menus. Another irritation: many of the 80 sentences used for the timed tests have to do with state capitals (cities, not buildings), which the author misspells “capitol” throughout. You can correct TYPE1's mistakes (there are others), or insert your own exercises—one of the few strengths of this otherwise amateurish program.

Touch 'n' Go (Caxton Software)

Work your way through Touch 'n' Go's 61 brief lessons, promise the authors, and you'll be able to type 40 words per minute with 95 percent accuracy. This program is excellent for beginners, but offers little to the intermediate or advanced typist looking to build skills.

Talk about minimal documentation: everything is on the disk jacket. A label would have sufficed. Type “C” to run the simple configuration program, then “T” to begin the lessons. After each session, press “R” to review your performance. Clear menus provide all the guidance you need—unless you have a question about how the program works, in which case you are out of luck.

More than any of the other programs, Touch 'n' Go acts as your teacher. There's a carefully planned sequence of exercises, and you advance only after meeting reasonable speed and accuracy criteria. The program moves along nicely if you follow the plan. Otherwise you rely on a slightly-clumsier-than-necessary series of questions and menus.

Beginning exercises consist of a line of simple letter combinations that you must type at 30 words per minute with 100 percent accuracy (for instance, “ed ed ed,” with “ed” repeated 17 times). You're allowed to correct mistakes, but repairs will cut down your speed.

Feedback is very good. As soon as you finish an exercise, errors are indicated with up-arrows, and your speed and accuracy scores are displayed. Words-per-minute scores seemed inflated, possibly because of the way the program counts words. Touch 'n' Go keeps a record of your performance during each session—the only program reviewed that does so. The next time you log in, you'll be reminded where you left off. Only the previous and current sessions are kept on disk, but you can easily get a printout to preserve the information.

As you know from school, the course with the terrific teacher may not have a great curriculum. So it is with Touch 'n' Go. Typing instruction normally places great emphasis on the “home” keys—A S D F J K L and ;. Touch 'n' Go not only omits the usual admonitions to keep your fingers on the home keys, it tacitly encourages wanton digital wandering.

For instance, one exercise in Lesson 5 calls for 10 repetitions of the word “tree,” which lures the fingers up to the QWERTY line. But you'll never be able to type without looking at the keyboard unless you keep your fingers in the home position. Why do you suppose the “F” and “J” keys of your Kaypro are especially deep?

Spreadsheet users will appreciate Touch 'n' Go's 13 lessons on the numeric keypad. However, there is no instruction for the numbers and symbols atop the letter keyboard—a significant omission, since many Kaypro users convert the numeric keypad to function keys for word processing.

When you're ready for longer sentences, Touch 'n' Go reaches new literary heights for typing instruction exercises by using famous quotations. An example: “In

giving freedom to the slave, we assure freedom to the free; honourable alike in what we give and what we preserve." But there's no ready way to insert "Four score and seven years ago . . ." if you want variety.

Touchtyp (Micro-Art Programmers)

Like Touch 'n' Go, Touchtyp is a self-contained typing course. This one has the excellent curriculum with the boring teacher. Still, it is worth considering for anyone high school age or older who wants more room for advancement than Touch 'n' Go provides.

Touchtyp's main menu takes you through beginning, intermediate and advanced lessons, ending with timed drills to build your speed.

The beginning lessons cover the alphabet and basic punctuation keys; intermediate lessons focus on the rest of the punctuation keys, plus numbers and symbols; the advanced section provides practice text that reviews everything.

Lessons are grouped in sections, each with its own irritating sub-menu of lessons. You have to enter 1 to get Lesson A, 2 to get lesson B, and so on. What's in these lessons? Simple as it would have been to provide this useful information, the menus don't say.

Touchtyp does a good job of integrating instruction and practice. Right after each brief lesson come relevant exercises—two to four lines for you to type. You'll find the familiar letter patterns in the exercises, but Touchtyp introduces real words and sentences very quickly. The drills, which focus on the most common English letter combinations, are excellent.

The text you type from is placed well above the text you enter, which makes it hard to spot mistakes as you go along. At the end of each brief exercise, Touchtyp redisplay the text as you typed it, then presents the correct version, highlighting your errors with a backslash in a way I found inconvenient to read. For instance, if you typed "Kayypro compute" the correction would read "Kayp\ro compute\r".

The correction display includes an error count, plus congratulations for a perfect performance and two levels of admonitions for those whose accuracy is substandard. Touchtyp and Touch 'n' Go are the only programs that don't penalize you for the rest of the line if you add or drop a single character. (Warning: don't be off by more than one.)

Touchtyp offers no easy way to repeat a lesson if you want more practice on a particular key—and you might, since the pace is quite rapid. Once you get into one of the five- to eight-lesson sections, you have to scroll through the entire set (or boot yourself back to the operating system) to return to a menu. After completing a section, a crude score is obtained by dividing your errors by the number of characters typed.

There's a simple installation procedure that sets up the timed tests based on your timing a ten-second interval. I got inflated speed scores, despite repeated installation attempts—a problem that stymied the

friendly person who answered my call to Micro-Art Programmers. Incidentally, the Touchtyp manual provides no instructions for redoing the installation, though a reasonably experienced user can figure it out.

Timed tests use four lines of text, drawn from a generous 100-line base. Errors are counted but not identified, even at the end—a drawback that probably isn't serious at this stage of the learning process. Typing tests for would-be secretaries have tough error penalties, but Touchtyp deducts only one word per minute for each typo.

Hypertyper (Summit Software Corporation)

This program has a little bit of everything: it's particularly quick and easy to use; the exercises and feedback are very good. Think of Hypertyper as a tool rather than a teacher. There's no helpful curriculum to follow, but you can benefit from the program regardless of your current typing skill.

For basic instruction, Hypertyper sends you to the manual, rather than the screen—a mistake, in my view. On the other hand, the drill is so well planned that your fingers effectively teach themselves.

The main menu offers options for learning and practicing specific keys (including both the keyboard numbers and the numeric keypad), plus general practice. You can also choose between using the space bar (word processor style) or the carriage return (typewriter style) to end one line and move to the next. The learning and practice submenus are excellent, since you can easily specify the keys you want to work on.

"Learn New Keys" brings up two lines of juj-type drill; "Practice Paragraph" has four lines of words and sentences focused on the selected group of keys. "General Practice" covers the entire keyboard, presenting four sentences per drill. The "Learn New Keys" drill never changes, but lines of words and sentences are chosen at random from a 40-line database. Though you may soon tire of the limited stock, no instructions are provided for inserting new text.

Hypertyper offers the best onscreen feedback of any of the programs reviewed. Mistakes are indicated immediately by the appearance of an up-arrow under the offending letter. After each drill, you get an error count and a raw words-per-minute score that doesn't take mistakes into account.

Hypertyper lets you zip around quickly and easily. After you complete an exercise, you can press Carriage Return to repeat it, or Escape to return to the menu. Unlike the other programs, Hypertyper never slows you down with superfluous questions and menus, or keeps you waiting while it loads up subroutines.

The two installation procedures are reasonably simple. You set the clock that calculates typing speed by timing a one-minute interval, which should be more accurate than the ten-second interval used by other programs. After the flattering scores I got from Touchtyp and Touch 'n' Go, Hypertyper's assessment

When you're ready for hard disk storage, HDS is ready for you.

You bought your KAYPRO[®] to help in your business — and it's given you a real head start. But lately, maybe you've started noticing a few little problems. Like lost time searching for the floppy with the right data. Or slow information retrieval or calculation. Or even lost data because a vulnerable floppy was damaged.

The answer isn't more floppies — you need the next logical step. An HDS 10MB hard disk subsystem to help keep your business on the grow, at a price even your accountant will love.

The HDS 10MB has all the features you expect from a truly state-of-the-art unit. Like half-height size; complete plug compatibility; five-minute installation; a dedicated power supply and a full, one-year warranty. Best of all, it comes at a price that's easy to take, starting at just \$1,249 for the 10 megabyte version. And when you're ready for more storage capacity, HDS is still ready for you with 15, 20 and 30 megabyte disk units; all with the same no-nonsense features.

Contact us today for full details or the name of the dealer nearest you. (Dealer and OEM inquiries welcome.)

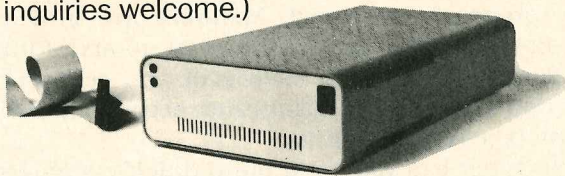

HDS

Huntington Data Systems

307 6th Street, Huntington Beach, Calif. 92648
(714) 960-7498

Solutions that work. For you.

TOUCH TYPING

brought me back to reality.

The bottom line

No single typing instruction program is best for everyone. A Boston Kaypro Users' Group member told me that his teenaged daughter learned touch typing from a public domain program; I tried that program (which makes you wade through 25 lines of drill before offering *any* feedback) and found it unbearably tedious. Obviously, you've got nothing to lose by checking out the free typing instruction software that turns up at user meetings and on electronic bulletin boards.

The proprietary programs reviewed here are not the only ones available for the Kaypro. I also looked at Type-Riter by Orange Microware, which is similar to the tedious public domain program mentioned above. On a more positive note, at least one new typing instruction program is in the works: as this issue of *Profiles* went to press, I heard about promising new software under development at Advent.

If I had to select a program for a high school or adult education typing course, Touchtyp would be the most appropriate of those reviewed here. The instruction is good, the exercises are well conceived, and the feedback should be sufficient for classroom use. Touch 'n' Go is a good choice for beginners of any age, provided their ambitions don't include auditioning for Kelly Girls. Hypertyper is what I'd recommend to families who want an all-purpose program that's suitable for kids, but challenging enough for parents who want to build upon the typing basics they learned in junior high school. □

Sarah Wernick is a freelance writer and editor, and a member of the Boston Kaypro Users' Group.

Quick Reference Summary

EATYPE \$12 Micro Cornucopia PO Box 223 Bend, OR 97709	Touchtyp \$49 Micro-Art Programmers 173 Birch Ave. Cayucos, CA 93430
TYPE1 \$25.50 (\$8.50 for demo) Wildriver Software 1111 Birch Dr. Hudson, WI 54016	Hypertyper \$29.95 Summit Software c/o Digital Marketing 2363 Circle Blvd., Suite 8 Walnut Creek, CA 94595
Touch 'n' Go \$29.95 Caxton Software c/o Software Research Technologies 3757 Wilshire Blvd., Suite 211 Los Angeles, CA 90010	□

HANDYMAN

TURN YOUR KAYPRO ON TO **HANDYMAN!!!**

AUTO DIALER

- Use your modem to make phone calls automatically without exiting the program you are already working on!!!

APPOINTMENT CALENDAR

- Check your calendar, schedule appointments anytime your Kaypro is on!!!
- Monthly calendars 1752-2099 AD!!!

NOTEPAD

- Write a note, paragraph, letter, a whole file; anytime, from within any other program!!!
- Edit another file without leaving your current file!!!

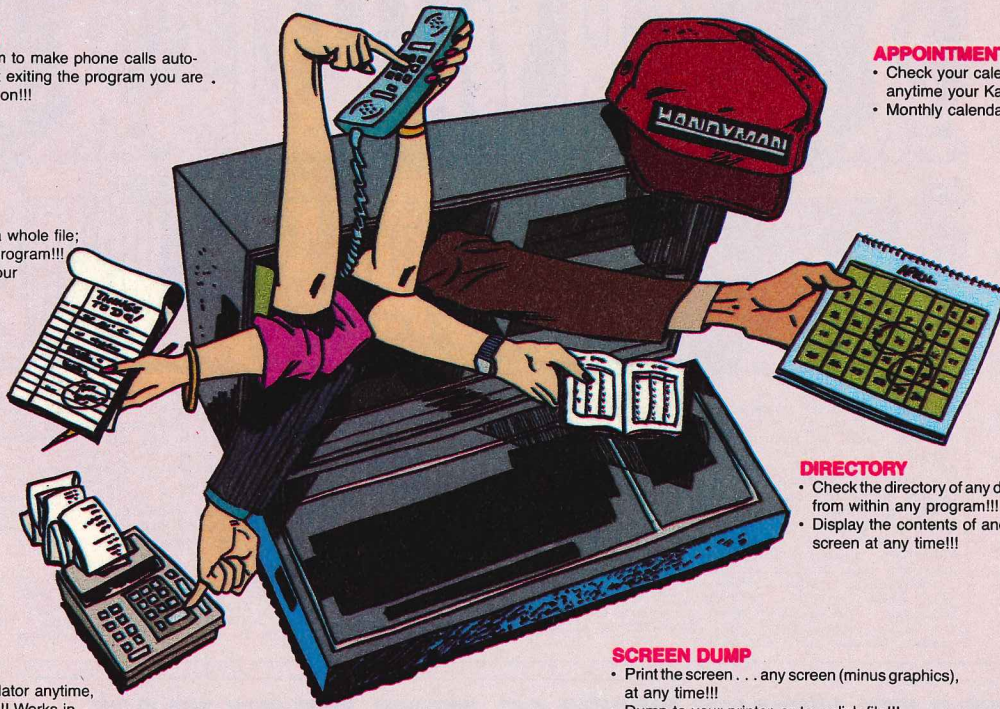

DIRECTORY

- Check the directory of any disk, any user number, from within any program!!!
- Display the contents of another file on your screen at any time!!!

CALCULATOR

- Punch up a four function calculator anytime, whenever your computer is on!!! Works in decimal, binary, hex!!! Works from within a spread sheet, or any other program!!!

SCREEN DUMP

- Print the screen . . . any screen (minus graphics), at any time!!!
- Dump to your printer, or to a disk file!!!

- "Disk Full" message? With **HANDYMAN** you can check the disk directory and erase superfluous files from within any program!!!



Turn your Kaypro on!!! **HANDYMAN** is there!!!

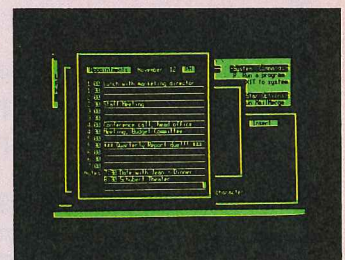
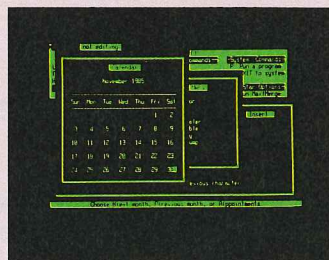
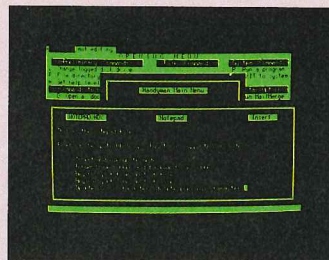
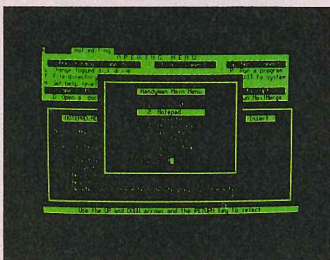

HANDYMAN is a plug-in board for your Kaypro!!!
HANDYMAN Works with all Kaypro CP/M models!!!
HANDYMAN Easy to install!!!!
HANDYMAN We'll talk you through it over the phone!!!

HANDYMAN Includes software in ROM and its own working RAM!!!
HANDYMAN You never have to load it!
HANDYMAN Single stroke commands!!!
HANDYMAN is compatible with all CP/M application programs!!!

HANDYMAN Uses no main memory!!!

FLO-SYSTEMS, INC.

3010 FLOYD STREET BURBANK, CALIFORNIA 91504 (213) 849-7711

Since 1976

YES! Send me _____ HANDYMAN(s) at \$124.95 each.

_____ (quantity) at \$124.95 \$ _____

California residents add 6.5% _____ Sales tax

Shipping and handling 5.00

TOTAL \$ _____

My KAYPRO is:

- II 2-84
- 2X 4
- 4-84 10
- Robie 10-84
- 4X 12X

Wordstar Perfect Writer **NOTEPAD** command set

Charge my

Card # _____ Exp. _____

C.O.D. and checks drawn on US banks also accepted.

Demo Packet

The crammed-full Demo Disk alone packs more punch than many programs costing well over \$100. You get:

- Printouts of 5 graphic samples (up to twice the size shown here), right on your printer!

- A shading program that prints any of the thousands of FRANK-ART shades & tones, on your printer!

- A fully interactive tutorial program that shows how easy FRANK-ART is to use - you actually move and shade images in any of thousands of ways, on your printer!

- FRANK-ART Idea Guide: details dozens of fun and money-making plans & businesses, such as personalized greetings & holiday cards, calendars, posters, advertising, commercial art, coloring books, nameplates, letter-heads, logos, etc.

Not bad, for an \$18 Demo Kit. And, all \$18 is applied to the purchase price of Standard or Deluxe FRANK-ART. PLUS, you can deduct the FULL purchase price of Standard FRANK-ART from the price of the Deluxe version, if you trade it in within 30 days of your purchase!

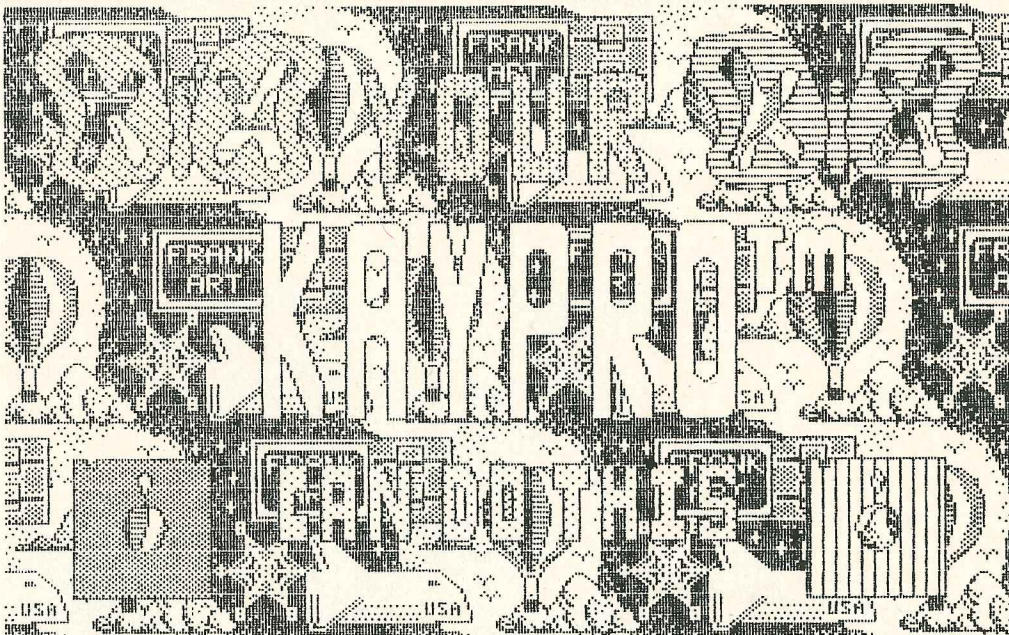

... and much, much more. FRANK-ART draws elegant & intricate dot-matrix printed graphics using your Kaypro. It works equally well with a graphic CRT or a standard non-graphic CRT. No additional software or hardware needed: no "mouse", no "digitizer", no memory expansion, no nothin'. Just FRANK-ART. And, it's all ready to go the moment it arrives. If you're not much of an artist, use the built-in libraries of background patterns, overlay images & typefonts, which you can easily position & shade automatically with any of thousands of built-in shading patterns & tones. If you're already an artist (or if you're ready to be), design all your own art with the FRANK-ART "micro-brush" program (which can also edit & customize both your designs and all those in the libraries). You can automatically stripe & slant your designs (as in the sample, or using other styles). Performs both normal & "reverse video" printing. You can also store all rough & final artwork to disk for future reprinting. And, FRANK-ART is already "camera ready", because it's all dots!

Sound impossible? The Demo Kit will make you a believer. You get not only a disk packed with solid graphics & interactive demos but an idea book that shows you the ways that FRANK-ART can be both fun & a great money-maker. And, there's more. If you design a good background, overlay or type-font for our libraries, we'll offer you a more than fair deal & market your design in our national catalog. Plus, the first 150 PROFILES readers who order will also receive the \$14.95 FRANK-ART Marketing Guide, free.

FOR: KAYPRO 2, 2X, 4, 4E, 4X & 10
PRINTERS: GEMINI 10X & 15X, EPSON RX80, RX100, LX80, FX80, FX85, FX100, FX185 [EPSON MX80, MX80FT & MX100 must be Model II, (or Model II with Graftrax 80 or Plus)] Note: Support for other printers is coming soon - stay tuned...

Standard FRANK-ART lets you create & edit detailed art up to 2"x2" sq. or 1"x4" Complete with thousands of built-in automatic shading patterns, "reverse video" printing, library of 5 art patterns, clear & complete instructions. \$77

Deluxe FRANK-ART (which produced the sample) includes all the above plus ability to blend images into giant art pieces, up to 5.3"x10". "Slants" background images, installs & shades overlays with any of thousands of patterns. Lets you create, overlay & shade type fonts, store & reprint all rough & final art. Includes 7 background patterns, 15 overlays (both general & holiday themes) & 5 sizes & styles of A-Z type fonts. Excellent Documentation. \$187

Colo. res. add 3% sales tax. All US orders are postpaid. Canadian ord. please add \$4; foreign: \$9 Specify computer and printer name/model & PLEASE clearly print or type your name & address. Send check or Money Order to:

FRANK-ART
PO BOX# 12282
BOULDER, COLO.
ZIP 80303-2697

CONTACT YOUR PUBLIC THE EASY WAY . . .

WITH THE E-Z MAIL COMPUTERIZED MAILING PROGRAM

E-Z MAIL is neat, inexpensive and modern. With your computer and the new, fast **E-Z MAIL PROGRAM**, you can maintain your mailing list efficiently. You can

- reach more people
- keep people informed
- save money maintaining mailing lists
- maintain your image

The **E-Z MAIL PROGRAM** needs NO programming, has NO mystery numbers, NO commands to memorize. At the touch of a button, the **E-Z MAIL PROGRAM**

VIEWS •SEARCHES •CHANGES •DELETES •EXTRACTS SUBLISTS •PRINTS OUT LABELS

Old mailing list systems are cumbersome, expensive, and obsolete. With **E-Z MAIL**, you simply **SELECT WHAT YOU WANT TO DO, AND E-Z MAIL DOES IT FOR YOU.**

Ask for **E-Z MAIL** at your local computer store, or **ORDER DIRECT** by sending \$125 to our office. (Add 6% tax for California residents; shipping is free). Phone orders (MC/VISA) accepted. OR, order the \$25 demonstration program.

E-Z MAIL runs on Kaypro and most other CP/M computers; **SPECIFY WHICH SYSTEM** you have.



ONLY \$125



Practical Business Software 3377 Solano Ave., Suite #307 Napa, CA 94558 (707) 253-8432

DU to the Rescue

Part 1: Into the jungle

by Ted Silveira

It was late. I had an article due the next day, but I wasn't worried. I just had to grab some information off one of my archive disks, merge it into the article, and presto—I was done.

I found the right disk, stuck it in the B drive, and warm-booted. I called for a directory of the new disk and listened to the B drive whirr. For a long time. Too long.

"Bdos Err On B: Bad Sector."

It's called a crash. One minute you're working with a disk full of important files. The next minute CP/M won't read the files, or tells you they don't exist, or refuses to acknowledge that your disk is in the drive. If you have current copies of all your files tucked away on another disk, you're safe. But if you don't have another copy, or you've just entered a load of new information . . .

There's still hope. With a disk editor, you can recover files, especially text files, from many kinds of crashes. Such a program lets you examine, change, and move information stored on any disk, byte by byte. With it, you can get to damaged files or disks that other programs refuse to recognize, like an explorer uncovering a lost city in the jungle.

Disk editors are powerful tools, and if you're careless, you can wipe out disks, even hard disks, in an instant. But don't think that disk editors are just for technical wizards. With patience and caution, you can pull off minor miracles even if you're a novice. Before you can, though, you need to know how disks and files are organized, how to use a disk editor, and what to look for when a disk or file crashes. This month, I'll introduce you to a disk editor and use it to start you on a guided tour of a disk. Next month, I'll finish the tour of both disk and disk editor and show you how to deal with some common crashes.

Getting a disk editor

All the disk editors I use come from the public domain—DU-V88, DU2, SUPERZAP, PATCH18A, and

others. In this article, I'm going to use DU-V88—it's not the slickest of the group, but it has the right features, and it's widely available. You can get DU-V88 from almost any CP/M bulletin board (if you have a modem) or CP/M users' group. If you can't find DU-V88 anywhere, you can get DU-V77 by mail for \$10 on KUG library disk 146 (P.O. Box 100, Malverne, NY 11565). DU-V77 is an earlier version, but it'll do the job.

Before you start

To work on your disks, you need to know how they're organized. If "tracks" and "sectors" are unfamiliar terms to you, read "How Disks Are Organized" on page 82. You also need to know something about bytes, hexadecimal numbers, and ASCII characters. If any of these is new to you, read "The Hex/ASCII Connection" on page 82.

Finally, you need to know whether you have single-sided or double-sided disk drives. If you have a Kaypro 2X, 4, or 10, you have double-sided drives. Since all these machines use the same floppy disk format, I'll refer to them generically as "Kaypro 4."

If you have a Kaypro II or 2, you have single-sided drives. I'll refer to both these machines as "Kaypro 2."

Getting ready

You need two blank, formatted disks with the CP/M system written on them. You can use old disks, but make sure you reformat them so they're wiped clean.

The Utility Disk. Label the first disk "Utility Disk," and copy the following programs onto it:

- DU-V88.COM, hereafter known as DU.COM or DU.
- D.COM or STAT.COM to show you the size of a file and how much free space is on a disk.
- PIP.COM, NSWPCOM, or some other program that will let you copy files *one at a time* (i.e., don't use COPY.COM, which copies the whole disk at once, track for track, or you won't have a clean disk, which could cause trouble).

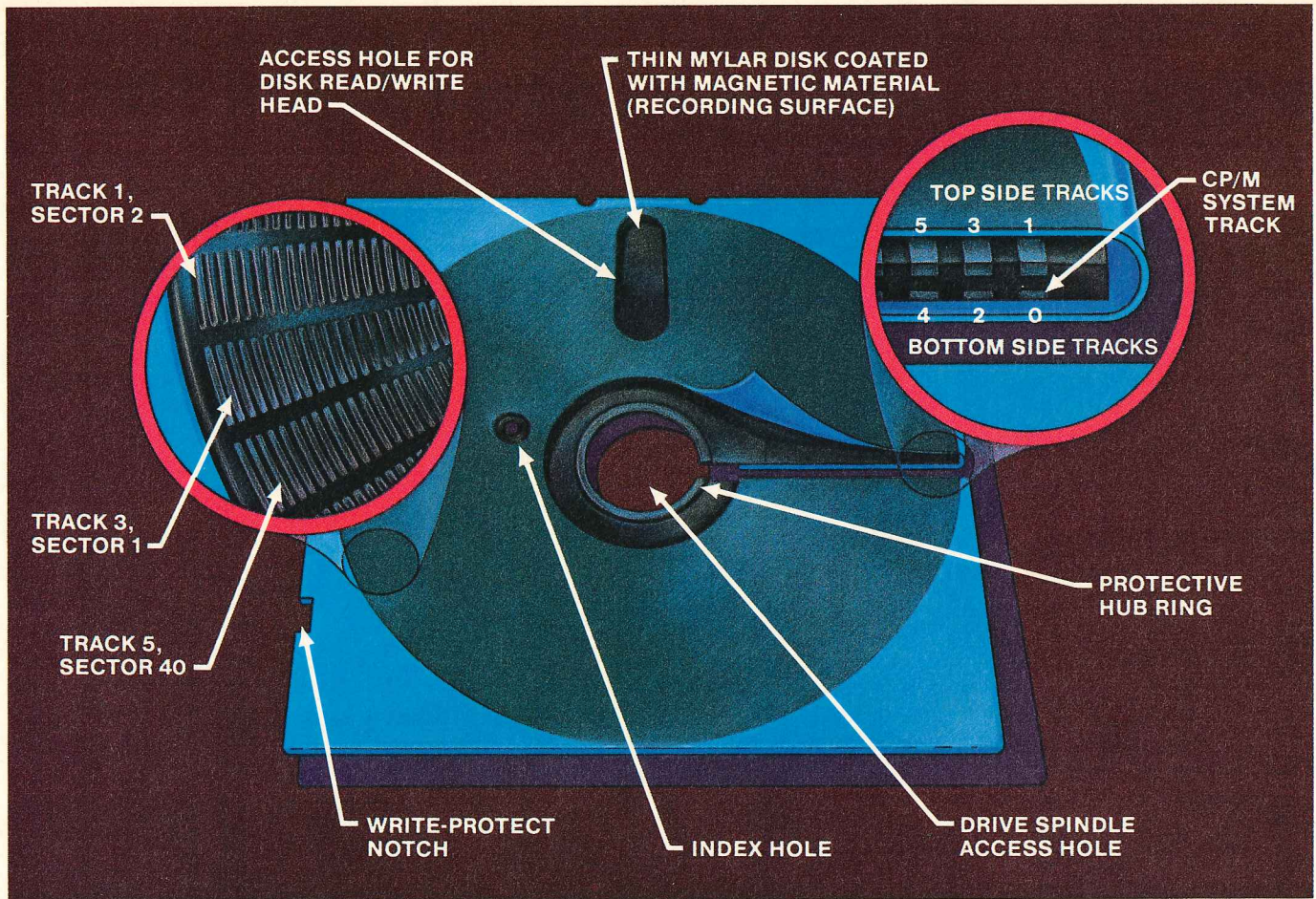

ANATOMY OF A KAYPRO DOUBLE-SIDED, DOUBLE DENSITY DISKETTE: As the righthand enlargement shows, the track count for the pictured double-sided diskette starts on the bottom with track 0, then alternates from top to bottom through to the innermost track, track 79 (80 tracks total). However, on Kaypro *single*-sided diskettes, all tracks are on the bottom with track 0 outermost, and track 39, innermost. When seen through DU, logical sector counts for both types of diskettes start with sector 1 (not sector 0), and go clockwise to sector 40 (see lefthand enlargement).

- your usual word processor.

Make sure you have backup copies of every program on the disk. However careful you are, you still may accidentally scramble part of this disk with the disk editor.

The Test Disk. Label the second disk "Test Disk." You need some files to practice on, so use PIP or NSWP (not COPY!) to move four or five text files and a couple of programs onto the Test Disk. For the text files, the content doesn't matter, as long as:

- they're all compatible with your usual word processor.
- they're all different (so you can tell them apart).
- they're all expendable.
- one file is larger than 32K (if you use the Kaypro 4 format), or larger than 16K (if you use the Kaypro 2 format) so that you can see how CP/M handles very large files.

For the programs, any will do.

After you've done all your copying, erase one file (so you can see what happens to erased files later).

You will *without a doubt* crash your Test Disk more than once, either on purpose or by accident, so **never** put any file on this disk that you can't afford to lose. On the label of my Test Disk, I've written in large red letters "WARNING—this disk may crash at any time."

Note to Kaypro 10 owners: I'm writing as if all

Kaypros had two floppy disk drives, but you, of course, have one floppy and one hard disk drive. Everything I say here applies to your floppy disk drive. Much of it also applies to your hard disk drive, but the details will be different—you'll have to translate and adapt. Above all, *don't* use DU to "experiment" on your hard disk; you risk destroying 10 megabytes of files. The Test Disk should be for your floppy disk drive *only*. Don't even think about poking around on the hard disk until you know DU inside and out. And before you do anything with DU, even on the floppy, make sure you have backup copies of everything on your hard disk stored safely.

Starting up

Put the Utility Disk in drive A and the Test Disk in drive B, and then enter ^C to warm boot your Kaypro. At the A> prompt, enter DU and hit RETURN. DU will load itself and show you this message:

```
DISK UTILITY v8.8
Universal Version under CP/M 2.2

Type ? for help
Type X to exit
```

:
DU immediately tells you the two things you most need to know—how to get help and how to get out. The mysterious colon (:) is DU's command prompt—it's

waiting for you to tell it what to do.

Getting Help. At the command prompt, enter ? to see a list of commands. DU will show you the first of four help screens and print the prompt “[more]” at the bottom of the screen. Hit any key (except ^C) to move on to the next help screen, repeating this process until you've returned to DU's command prompt (:). These help screens are just for reference, so the command descriptions are very brief; don't worry if you can't decipher them right now.

Aborting an Operation. You can enter ^C to force an emergency halt of anything DU is doing. If you enter ^C at the “[more]” prompt, DU will return to its command prompt without continuing through the rest of the help screens.

Exiting DU. To exit DU, enter X at the DU command prompt; DU will return you to CP/M. Try it, and then start up DU again just as you did before.

Changing Drives. When you run DU from the A> prompt, it comes up ready to work on your current (or “logged in”) drive, drive A. To change drives, use the “L” command—enter L plus the letter of the drive you want to move to. To get to your Test Disk, you must move to drive B, so at the command prompt, enter LB, which tells DU that you want to Log in drive B. You'll hear whirring from your disk drives, and you'll get a new command prompt (:). To move back to drive A, enter LA.

Other than the drive noise, DU gives no sign that it has moved to the new drive.

Getting Information about the Current Drive. To confirm that DU has moved to the new drive, use the “#” command. Enter # at the command prompt, and DU will print the screen you see in Listing 1a or 1b. Don't worry if most of this information means nothing to you now; it will soon. For the moment, look only at the top line, which tells what your current drive is. If it doesn't say “Statistics for drive B:,” use the L command to move to drive B. Then use the # command again to make sure you got there.

```
: #
Statistics for drive B:
Tracks:      80      5 0
Sys tracks:  1       0 1
Sec/track:   40      2 8
Groups:     196     C 4
Dir groups:  2       0 2
Sec/group:   16     1 0
Dir entries: 64     4 0
```

LISTING 1a: Drive statistics for a Kaypro 4, double-sided drives, as shown by DU-V88.

```
: #
Statistics for drive B:
Tracks:      40      2 8
Sys tracks:  1       0 1
Sec/track:   40      2 8
Groups:     194     C 2
Dir groups:  4       0 4
Sec/group:   8       0 8
Dir entries: 64     4 0
```

LISTING 1b: Drive statistics for a Kaypro 2, single-sided drives, as shown by DU-V88.

The rest of the display gives information about how your Kaypro's disks are organized. The lefthand column of numbers is in everyday decimal, the righthand column in hexadecimal.

Moving around the disk

Now that you're logged in to drive B, where the Test Disk is, you can use DU to move around the disk, to any track and sector you want.

Moving by Track and Sector. To move to a particular track, use the “T” command, followed by the number of the track you want (track numbers are always given in decimal). At the DU command prompt, enter T0 to move to track 0, T1 to move to track 1, T39 to move to track 39, and so on.

Don't even think about poking around on the hard disk until you know DU inside and out.

By itself, the T command doesn't cause the disk drive head (the part that “reads” the disk) to move to a new track; it just *selects* the track you want. The actual move takes place only after you also select a sector.

The “S” command, for moving to a particular sector on the current track, works like the T command—you enter S followed by the number of the sector you want (sector numbers are always in decimal, too). Enter S1 to move to sector 1 of the current track, S2 to move to sector 2, and so on.

If you've already selected a new track, you'll probably hear some noise from the disk drive after you use the S command—that's the disk drive head moving to a new spot. Move back and forth between track 0, sector 1, and track 39, sector 40, and listen.

Knowing Where You Are. After each track or sector move, DU displays a line telling you where you are, like this:

T=0, S=1, PS=0

The first part of this status line (T=0) gives your current track (track 0) and the second part (S=1) gives your current sector (sector 1). This sector, the one you address with the S command, is sometimes called a *logical* sector. The third part of DU's status line (PS=0) gives your current *physical* sector.

To DU, the difference between logical and physical sectors is their numbering: physical sectors are numbered in the order in which they're laid out on the track; logical sectors are numbered in the order in which they're used by CP/M. In the Kaypro, DU considers logical and physical sectors to be the same, except that logical sectors are numbered starting with 1 and physical sectors starting with 0. Fortunately, you can ignore

physical sectors for everything I'll cover in this article. You'll be working only with logical sectors, which I'll just call "sectors" from now on.

Moving One Sector at a Time. To move just one sector forward or back from your present position, you can use the "+" and "-" commands. Enter + at the command prompt to move forward one sector (from sector 2 to 3, for example). Or enter - at the command prompt to move back one sector (from sector 2 to 1, for example).

Move to sector 40 of your current track and enter +; you'll move to sector 1 of the next track. Move to sector 1 of your current track, and enter -; you'll move to sector 40 of the previous track. Move to track 0, sector 1, and enter -; you'll end up on track 79 (track 39 if you have a Kaypro 2), sector 40.

Play with the T, S, +, and - commands a bit, and then move to track 1, sector 1. Here you'll find the first of 16 logical sectors that make up the disk directory, which tells what files are on your disk and where they are.

Viewing the disk directory

To see what's in this sector of the directory, use the "D" (for Display) command. Enter D at the command prompt.

Reading the DU Display. When you look at the first sector of the disk directory, you should see a display like that in Listing 2 (though the actual file names and other details will be different).

On the right side of the display in Listing 2, you'll see a block of letters and periods, eight rows deep by 16 columns wide, set off by a column of asterisks (*) on either side. This block gives the ASCII display of this sector—if a byte can be shown as a printable ASCII character, it is; if not, it is shown as a period (.). Within this block, you can make out three file names—FLMKTO01.TXT, BIO.TXT, and MONSTER (entered twice).

```
G = 00:00, T = 1, S = 1, PS = 0
:D
00 00464C4D 4B543030 31545854 00000058 * .FLMKT001.TXT... [*
10 02030405 06070809 00000000 00000000 * . . . . . [*
20 E542494F 20202020 20545854 00000003 * eBIO . . . . . [*
30 08000000 00000000 00000000 00000000 * . . . . . [*
40 004D4F4E 53544552 20202020 01000080 * .MONSTER . . . . . [*
50 090A0B0C 0D0E0F10 1112191A 1B1C1D1E * . . . . . [*
60 004D4F4E 53544552 20202020 03000003 * .MONSTER . . . . . [*
70 1F28292A 2B2C2D2E 2F000000 00000000 * ( ) * + , - / . . . . . [*
```

LISTING 2: This shows the display given in response to DU-V88's D command. It shows the first sector of the disk directory (track 1, sector 1) on my Test Disk.

The rest of what you see in Listing 2 is the hexadecimal display of this sector—it's not easy to read at first. The leftmost column contains two-digit row numbers that you'll use for reference later. In between this column and the ASCII display, you'll see four blocks of

hexadecimal numbers that make up the hexadecimal display. This display shows every byte in this sector as a *two-digit* hexadecimal number—if you read the top line of the display, the first byte is 00h, the next is 46h, the next 4Ch, and so on.

In Listing 3, I've tried to create a clearer picture of the hexadecimal display from Listing 2 by adding spaces to separate the bytes and column numbers (00-0F) along the top to help identify the location of each byte. If you start in the upper lefthand corner of the display (row 00, column 00), the first byte (00h) is at location 00. Moving to the right, the next byte (46h) is at location 01 (row 00, column 01), the next (4Ch) at location 02, and so on to the last byte (5Bh) in this row, at location 0F. In the next row down, the leftmost byte (02h) is at location 10 (row 10, column 00), the byte to its right (03h) is at 11 (row 10, column 01), the next byte (04h) is at 12, and so on. This numbering continues through the bottom row, locations 70 through 7F.

	00	01	02	03	04	05	06	07	08	09	0A	0B	0C	0D	0E	0F
00	00	46	4C	4D	4B	54	30	30	31	54	58	54	00	00	00	5B
10	02	03	04	05	06	07	00	00	00	00	00	00	00	00	00	00
20	E5	42	49	4F	20	20	20	20	20	54	58	54	00	00	00	03
30	08	00	00	00	00	00	00	00	00	00	00	00	00	00	00	00
40	00	4D	4F	4E	53	54	45	52	20	20	20	20	01	00	00	80
50	09	0A	0B	0C	0D	0E	0F	10	11	12	19	1A	1B	1C	1D	1E
60	00	4D	4F	4E	53	54	45	52	20	20	20	20	03	00	00	03
70	1F	28	29	2A	2B	2C	2D	2E	2F	00	00	00	00	00	00	00

LISTING 3: This listing reproduces the hexadecimal display from LISTING 2 in a modified form. I have added spaces and column numbers to show the location of each byte more clearly.

In other words, a byte's location is the combination of its row number and column number—to find location 5F, you look in row 50, column 0F.

Using this system, you can refer unambiguously to any byte in the sector by its location. At location 43 (row 40, column 03), you'll find the byte 4Eh; at location 5C, the byte 1Bh; at location 76, the byte 2Dh. You'll also use this same system of referring to byte locations later, when you change the bytes in a sector.

Now look back at Listing 2, where you can see the two displays, hexadecimal and ASCII, side by side. These two displays show exactly the same information—only the form is different. In the hexadecimal display, for example, the byte in location 01 is 46h; in the ASCII display, the same byte is F. If you look at the ASCII table in your *Kaypro User's Guide*, you'll see that the code for uppercase F is, in fact, 46h.

Understanding the disk directory

Once you can read DU's display, it's fairly easy to understand the disk directory itself. Every file on a disk has at least one entry in the directory. In Listing 2,

which shows the first sector of the directory on my Test Disk, there are four entries, each taking two lines (32 bytes). The first entry (locations 00-1F) is for a file called FLMKT001.TXT. The second entry (locations 20-3F) is for the file BIO.TXT, while the third and fourth entries (locations 40-5F and 60-7F) are taken by one large file, MONSTER. Now look at the directory of your own Test Disk; you should see some of the files you put on it, laid out in a similar way.

The User Code. The first byte in every directory entry is the user code, which tells whether a file is active or not. If the file is active, the user code is usually 00h (I'll cover other possibilities next month.) If the file has been erased, the user code is E5h. For the first entry in Listing 2, FLMKT001.TXT, the user code (location 00) is 00h, so the file is active. For the next entry, BIO.TXT, the user code (location 20) is E5h, so the file has been erased.

The Filename and Filetype. After the user code, the next eight bytes in a directory entry (locations 01-08) contain the filename, and the following three bytes (locations 09-0B) contain the filetype. For the first entry seen in Listing 2, FLMKT001.TXT, the filename is FLMKT001 and the filetype is TXT. For the second entry, BIO.TXT, the filename is BIO and the filetype TXT. For the third and fourth, the filename is MONSTER, and there is no filetype. As you can see from the second, third, and fourth entries, any unused locations in the filename and filetype are filled with 20h, the ASCII code for a space.

The Storage Map (Group Numbers). The second line of any directory entry is a map that shows where a file is stored on the disk by listing its "allocation groups" (sometimes called "allocation blocks" but usually just called "groups").

What's an allocation group? When CP/M allocates disk space for a file, it doesn't do so one sector at a time—that would require too much record keeping. Instead, CP/M treats a number of sectors as a group and allocates space one *group* at a time.

Different computers may use different group sizes. The Kaypro 2 uses eight sectors per group (8 sectors/group X 128 bytes/sector = 1024 bytes/group, which computer people call 1K bytes). The Kaypro 4 uses 16 sectors per group (2K bytes/group). If you use DU's command again to get your drive statistics, the sixth entry (Sec/group) will tell you how many sectors per group your computer uses.

Because a group is the smallest space CP/M can allocate to a file, it determines the minimum file size. If you have a Kaypro 2 and create a WordStar file with only one character in it, STAT.COM (or D.COM) will say the file's size is 1K. If you create the same file on a Kaypro 4, STAT.COM will say the file's size is 2K.

Now look at Listing 2 again. In the first directory entry, the second line (locations 10-1F) shows the group numbers allocated to FLMKT001.TXT. This file takes up six groups, numbers 02h through 07h (group num-

bers are always hexadecimal). The unused locations in the storage map are filled with zeros.

If a file takes up more groups than can be listed in a single directory entry, CP/M opens a second entry for it (and a third, fourth, etc., if needed). In Listing 2, MONSTER takes up 25 groups, so it has two directory

Once you can read DU's display, it's fairly easy to understand the disk directory.

entries. Sixteen groups (09h-12h and 19h-1Eh) are listed in the first entry, the remainder (1Fh and 28h-2Fh) in the second.

When CP/M allocates space for a file, it doesn't try to keep all the pieces of the file in the same place; it jumps all over the disk, sticking the pieces in wherever it can find room. For example, MONSTER's first directory entry jumps from group 19h to group 1Eh, and its second entry jumps from group 1Fh to group 28h; the missing groups (1Ah-1Dh and 20h-27h) have been allocated to other files somewhere else in the directory.

The Logical Extent Count. The 13th byte in a directory entry shows the logical extent count. Unfortunately, there's practically nothing logical about this one—if tracks, sectors, and groups haven't boggled your mind already, logical extents surely will.

Some history may help. In early versions of CP/M, all computers had to use a group size of 1K (as the Kaypro 2 does now). Using these 1K groups, a single directory entry could only cover 16K bytes of a file (because there are only 16 slots to list the group numbers in); any file over 16K required more than one directory entry. The maximum amount of space that could be covered in one directory entry (16K) became known as an "extent," and within a single file, each extent was numbered (00, 01, 02, etc.) so that CP/M knew which contained the first part of the file, which the second, and so on.

The current version of CP/M still uses the 16K extent (now called a "logical extent") to keep track of files, but it allows computers to use group sizes larger than 1K, so they can cover more than 16K in one directory entry. As a result, a single directory entry can cover more than one logical extent. The Kaypro 4, with its 2K groups, can cover 32K (two logical extents) in one entry.

Each time a logical extent is filled (i.e., 16K worth of groups is added to the directory entry), a new logical extent is opened, even if it only contains one sector of one group. The 13th byte in a file's directory entry (location 0C for FLMKT001.TXT in Listing 2) shows the current logical extent being used by this directory entry.

In Listing 2, which shows part of the directory from a Kaypro 4, the logical extent counts for FLMKT001.TXT

(location 0C) and BIO.TXT (location 2C) are both set to 00h. Neither of these files is larger than 16K, so neither has filled up the first logical extent (extent 00). The two directory entries for MONSTER, however, tell a different story. The first directory entry for MONSTER is full (32K worth), and the logical extent count is set to 01h (location 4C), meaning that the first two logical extents (00 and 01) are being used. In the second directory entry for MONSTER, the logical extent count is set to 03h because the next two logical extents (02 and 03) are being used, even though the last one (03) is not full.

I apologize for this long excursion into the meaning of logical extents, especially since you'll rarely need to do anything with them. You will need to understand them, however, if you should ever have to build a new directory entry in the course of rescuing a file.

The Record Count. The 16th byte in a directory entry (location 0Fh for FLMKT001.TXT) shows a count of the number of sectors (called "records" in this case) used in the highest numbered logical extent of this entry. In Listing 2, the record count for MONSTER's second directory entry (location 6F) is 03h, so only three sectors of the current logical extent (03—see location 6C) have been used.

The remaining two bytes in a directory entry are the 14th and 15th (locations 0D and 0E for FLMKT001.TXT); these are used for housekeeping by CP/M and should be 00h.

Moving around the disk by group numbers

When you first moved to the disk directory (using **T1** and then **S1**), DU added something to the line displaying your current track and sector. Along with the track, sector, and physical sector, DU told you that "G=00:00" (see Listing 2). This figure indicates what allocation

When CP/M allocates disk space, it does so not a sector but a group at a time.

your current group number, and the number to the right of the colon indicates your current sector within the group (both in hexadecimal).

In Listing 2, the group is 00h because the disk directory, on track 1, is always the first group on the disk (the system track, track 0, isn't divided into groups). The sector is also 00h because Listing 2 shows the first sector of the directory. (The first sector in a group is 0, but the first sector on a track is 1—I wish these people would make up their minds.) As you move around on the disk, you'll see the group and sector numbers change.

Because files are usually dealt with by allocation groups, DU lets you move directly to any group with the

"G" command. At the DU command prompt, enter **G** plus the number, in hexadecimal, of the group you want. **G02** will take you to group 02h, **G2F** will take you to group 2Fh, and so on. To return to the disk directory, enter **G00**.

Do some experimenting on your own. Go to the directory on your Test Disk and display a sector. Choose one of the text files, identify its first group number, and use the G command to move to that group. Once you're there, display the first couple of sectors, looking at the ASCII display—it should show the beginning of the file you chose. Do the same thing with a few other files.

You'll need to understand logical extents to build a new directory entry.

A teaser

This month, I've covered how disks are organized, how to move around a disk with DU, how to read DU's display, and how to read a disk directory. Next month, we get to the really interesting part—how to change or move bytes with DU and what to do with crashed disks and files.

Just for fun, though, try this. Go to the beginning of the your Test Disk directory and display the sector. Now, at the command prompt, enter **CH00,E5**. This command tells DU to Change the Hexadecimal byte at location 00 to E5h. Display the sector again, and you'll see that the byte at location 00 has been changed to E5h—you've erased the file in the first directory entry.

So far, the change is only temporary, so enter **W** at the command prompt to Write the changed sector onto the disk. Now exit DU and use STAT.COM, D.COM, or DIR to list the files on your Test Disk—the file you erased will be missing.

Now run DU again, log on to your Test Disk, go to the beginning of the directory, and display the sector. The directory entry for the erased file is still there; it just has its user code set to E5h. Now at the command prompt, enter **CH00,00** to Change the Hexadecimal byte at location 00 to 00h. Display the sector to make sure the change was made, and then enter **W** at the command prompt to write the change to the disk. Now exit DU and list the files on your Test Disk again—your file is back. You've erased and unerased a file.

See you next month. □

Ted Silveira is a freelance writer and editor and has taught writing at San Francisco State University. He is also a consultant for novice CP/M users and software librarian of a CP/M users' group.

(Please see related article on page 82.)

Rembrandt

Complete Business Graphics Toolkit™

REMBRANDT gives you three easy-to-use tools that allow even the most inexperienced user to quickly master Kaypro graphics:

•**GRAPH** enables quick and easy creation of business graphics including horizontal and vertical bar graphs, pie charts and xy plots (scatter graphs) - uses hand entered data or reads numerical data from just about any source including dBase II, spreadsheet, Mbasic and Wordstar files.

•**BOARD** is the full-screen graphics editor for your computer. Create graphic screens, save and recall them to and from disk. Layout forms, design logos, draw pictures. It's easy and fun to use!

•**BRIEF** produces electronic on-screen "slide shows" with absolutely no programming required! GRAPH and BOARD files are easily sequenced using nine or more "cinematic" special effects!

REMBRANDT is complete with printer routines so graphics can be printed on virtually every dot-matrix or daisy-wheel printer (Epsons, NEC, Okidata, Qume, Kaypro daisy wheel printer and more. Call or write for complete list.)

REMBRANDT the Complete Business Graphics Toolkit is \$79.95 Available for Kaypro 2-84, 2X, New 2, 4-84, 4E, 4X, 10 and Robie

**NEW Version 3.00
now available!!**

NEW FEATURES:

Full integration with any word processor - combine text and graphics. Create custom letterheads, business reports and more!

Now includes automatic line, circle and box drawing modes

Type in "GIANT" characters five times normal size

XY plots with three symbols

New printer support (Apple Dot Matrix & Imagewriter, IDS Prism, Microprism and 480)

UPGRADE POLICY:

Current REMBRANDT owners may return their original distribution diskettes for a \$60 credit toward Version 3.00

Make your KAYPRO 2 or II computer IBM-PC compatible for just \$29.95!
READ, WRITE and FORMAT 25 different types of disks (including IBM PC-DOS/MS-DOS) with...



MEDIA MASTER gives your Kaypro 2 or II instant access to program and data files in 25 disk formats including:

Osborne SD & DD	LNW-80	Cromemco w/Int' Term	Xerox 820 I SD
IBM PC-DOS 1.0 & up	TRS-80 with Omikron CP/M	Cromemco CDOS SSDD	Xerox 820 II DD
IBM PC-DOS 2.0 & up	TRS-80 III w/Memory Merchant	Cromemco CDOS SSSD	Zenith Z90
IBM CP/M-86	TRS-80 IV with CP/M+	TI Professional CP/M-86	DEC VT180
Morrow MD2	Heath Z100	Actrix	NEC PC-8001A
Systel II	Heath w/Magnolia CP/M	Lobo Max-80	Kaypro II

ORDERING INFORMATION: Include \$3 per order for postage/handling. Overseas airmail add \$10. US funds only. California residents add 6% (LA County, add 6.5%).

To place COD or credit card orders:



Call TOLL FREE 24 hours: 800-824-7888 (Operator 409)

Alaska, Hawaii: 800-824-7919 (Operator 409) Technical questions: call 818-716-1655

For more information, a free brochure (including sample printouts and reviews), or to order, contact:

formerly
DG/SYSTEMS



**22458 Ventura Blvd., Suite E
Woodland Hills, CA 91364**

Software also available for IBM, ZENITH, OSBORNE and DEC RAINBOW computers. Dealer inquiries invited.

MAXIMIZE YOUR

SPECIALS OF THE MONTH

In support of this issue's editorial theme, Advent is offering the following specials:

Word Wiggle: Scrambled letter game for building vocabulary skills of young and old. Eleven skill levels containing 40,000 word dictionary. Fast paced, fun, and educational.
Word Wiggle (CP/M & MS-DOS) ~~\$29.95~~ ... \$24.95

Reading Professor: Now you can use your computer to boost your reading speed while increasing comprehension and retention! Self paced lessons show immediate improvement and feedback. Includes several different practice exercises. Developed by skilled educators, this program tracks user's progress and monitors reading rates up to 2500 wpm. Additional reading libraries available.
Reading Professor (CP/M & MS-DOS) ~~\$59.95~~ ... \$49.95
Additional Libraries (each) ... \$15.95

SAT score builder: RSI Software - This program is designed to help students prepare for the Scholastic Aptitude Test required by most colleges and universities. Includes Help function.
College Board Score Builder ~~\$34.95~~ ... \$32.95

Math Tutors: RSI Software - Improve your skills in basic thru advanced math. Learning thru multiple-choice problems with help and hint functions provided. Grades 8-College.
Algebra \$34.95 ... ~~\$32.95~~ **Calculus** ~~\$34.95~~ ... \$32.95
Geometry \$34.95 ... ~~\$32.95~~ **Trigonometry** ... ~~\$34.95~~ ... \$32.95

FREE Keyboard Template: Order any two items and receive our popular keyboard template. Instantly places WordStar commands at your fingertips. A 16.95 value FREE!

SERVICES SIZE

File Transfer Service: Advent provides a service beyond the ability of any format conversion software! We can transfer files between MS-DOS/PC-DOS, CP/M and other operating systems in 300 different 3 1/2", 5 1/4" and 8" formats. Includes Apple, Apricot, Data General I, Kaypro 2000, Eagle, Epson QX-10 & PX-8 (ROM), HP-150, and North Star computers.

..... **Call for information and pricing**

We publish software. If you have a program you'd like to have published, let us know. For further information call, (714) 630-0446.

HARDWARE & ACCESSORIES

External Monitor Adaptor: The External Monitor Adaptor (EMA) allows your Kaypro to drive an external video monitor. Original characters and video display remain unchanged. The Kaypro monitor remains operative. Simple plug-in installation.

EMA Kaypro II or 4	\$59.95
Taxan 115 Monitor (12" Green)	\$149.95
Taxan 116 Monitor (12" Amber)	\$159.95
EMA Kaypro 2'84, 2X, 4'84, 10'84	\$74.95
EMA Kaypro 10'83	\$82.95
12" Green Monitor*	\$159.95
12" Amber Monitor*	\$169.95

* Specially modified monitors must be used with all Kaypros except the original model II and 4.

5 MHz TurboBoard: Our tried and true 5 MHz speed enhancement for the earlier Kaypro models.
5MHz TurboBoard for Kaypro II & 4 \$74.95

Clock/Calendar: Real time clock/calendar add-in for all Kaypro computers without built-in clocks. Works with Plus* Perfect DateStamper or your own application software. Source code drivers provided for use with MBASIC, SBASIC, dBASE II, Turbo Pascal, C, and assembly languages. The Clock/Calendar also functions as a host adapter to our RAM disk and hard disk add-on products. Add these other products later and save money.
Clock/Calendar Interface \$99.95

TurboROM: A ROM enhancement for all 8-bit Kaypro computers. Faster disk read/write, keyboard type-ahead, faster video display for newer Kaypros, and larger TPA (63K) for the Kaypro 10. The TurboROM supports up to four 48TPI (392K) or quad density 96TPI (790K) floppies all with 255 directory entries. Additional drives require our Personality/Decoder Module. Other features include a built-in driver for our RAM disk, and versions that support up to 112Mb of hard disks.

KII/4 TurboROM for Kaypro II or 4'83	\$59.95
KII/4H TurboROM (hard disk version)	\$69.95
K84 TurboROM for Kaypro 2'84, 4'84, 2X	\$59.95
K84H TurboROM (hard disk version)	\$69.95
K10 TurboROM for Kaypro 10'83	\$69.95

Electronic RAM Disk: High speed internal RAM disk for all Kaypro models. Expandable to 1 Mb in 256K increments, then add the 1 Mb expansion board for a full 2MB RAM disk. This RAM disk delivers more performance than the competition. Add hard disks or Real Time Clock later and save.

Speed Comparison - At 4 MHz, times measured in seconds.

Function	Floppy	SWP	Micro C	Advent
Load Ladder	8.89	1.82	2.21	.80
Save 64K file	55.65	2.96	3.25	1.52
256K RAM Disk				\$399.95
512K RAM Disk				\$504.95
768K RAM Disk				\$599.95
1Mb RAM Disk				\$689.95
1Mb Expansion Board (256K installed)				\$329.95
256K Expansion Memory kit				\$115.00

Hard Disk Add-in (Kaypro 10): Add an additional 10 or 20Mb drive inside your Kaypro, or install a single 32 to 56Mb drive. Package includes hard disk, all cables and mounting hardware. TurboROM included. Add RAM disk or Real Time Clock later and save.
10 to 56Mb Hard Disk Kit **Prices start at \$689.95**

Hard Disk Add-in: Add an internal 10 to 56Mb hard disk to any floppy disk based Kaypro computer. Includes hard disk, disk controller, all cables and mounting hardware. TurboROM included.

10Mb System	\$1075.95
20Mb System	\$1506.95
32Mb System	\$1639.95

External Hard Disk Add-on: Add an external enclosure with 10 to 112Mb of hard disk and up to 2Mb of RAM disk to any 8-bit Kaypro. Mix and match to meet your needs.
External Hard Disk Add-on **Prices start at \$1523.95**

Printer & Modem Cables: These high quality cables are designed to work between your particular printer or modem and your Kaypro. Specify make and model of printer and Kaypro model when ordering.

RS-232 Serial:	6ft - \$17.95	12ft - \$22.95
Kaypro 16 RS-232 Serial:	6ft - \$19.95	12ft - \$24.95
Centronics Parallel:	6ft - \$24.95	10ft - \$28.95
Kaypro 16 Parallel:	6ft - \$27.95	10ft - \$31.95
Modem Cable:	2ft - \$19.95	4ft - \$22.95

12ft Keyboard Cable: Replace the original 4ft cable. Designed to meet the exacting requirements of your Kaypro.

12ft Keyboard Cable \$9.95

Anti-Glare Screen: Increases contrast and reduces glare. Attaches directly to the CRT and requires no disassembly. Please specify **Smoke** or **Green** when ordering.

Anti-Glare Screen \$19.95

Kaypro Carrying Case: This fully padded case, made from Cordura, is completely enclosed and has a padded shoulder strap. Comes complete with pockets to carry your manuals and diskettes. Please specify **Blue** or **Black** when ordering.

Kaypro Carrying Case \$69.95

Finger Print "Letter Writer": Add near-letter-quality print, IBM and Apple Graphics printer emulation, plus 16 other print functions to your Epson FX series printer! Replacement ROMs, easy installation does not void printer warranty.

Finger Print "LetterWriter" \$79.95

SOFTWARE UTILITIES

Autodiff: File difference detector. This program finds insertions, deletions, and changes between any two files. Autodiff can mark the file, display, or print the differences, and more!
Autodiff (CP/M) \$29.95

CP/M DateStamper: Automatically stamp your files with the date it is created, last read, or modified. Works without a Real Time Clock, with the clock in the newer Kaypros or with the Advent Clock/Calendar. Utilities are included to allow copying, erasing, or renaming files based on time and date. A time logging utility is included to record computer usage for business/tax purposes.
DateStamper \$49.95

Format Conversion Software: Your Kaypro can read and write many popular disk formats including MS-DOS and PC-DOS.

Media Master: up to 75 formats (all Kaypros) \$39.95

Uniform: up to 80 formats (all Kaypros) \$69.95

Sidekick: One of the most popular programs ever written. Use Sidekick as a calculator, notepad, appointment calendar, auto dialer, ASCII conversion table and much more. On-line help if you forget any of Sidekick's many functions.

Sidekick (MS-DOS) \$54.95

KAYPRO-FORMANCE

SmartKey: Saves you time. Makes every software program you use easier. Can reduce keystrokes by more than 50% by redefining any key to be any combination of characters or commands that you desire.

SmartKey \$49.95

SmartPrint: A powerful add-on to SmartKey, SmartPrint is a versatile writing tool designed to give you full access to your printer's features such as wide, bold, condensed, underlined, subscript, superscript, and more. Works great with programs like WordStar.

SmartPrint FREE WITH SMARTKEY PURCHASE

XTREE: Directory maintenance program that graphically displays sub-directories and filename-paths. Complete control of your directory including delete, rename, view, list or show. A must for any IBM or clone.

XTREE \$49.95

ZP/EM: Run almost any CP/M program on your IBM or clone. Use with Media Master or Uniform to allow programs on CP/M disk formats to run directly on your MS-DOS computer.

ZP/EM \$59.95

PROGRAMMING CORNER

C/80 Ver 3.1: Full featured C compiler and runtime library. One of the fastest on the market. Mathpak is included for true 32 bit floating point and signed integers.

C/80 Ver. 3.11 - QX10 \$79.90

Toolworks C: This compiler is a complete subset of C. The two-pass compiler produces relocatable object files (.obj) which are compatible with the MS-DOS LINK program. Mathpak is included for true 32 bit floating point and signed integers.

Toolworks C: Compiler - QX16 \$79.90

C Mathpak (CP/M & MS-DOS) \$29.95

Turbo Pascal Ver 3.0: (CP/M & MS-DOS) \$69.95

Turbo Toolbox: (CP/M & MS-DOS) \$54.95

Turbo Tutor: (CP/M & MS-DOS) \$24.95

Turbo Graphics (MS-DOS) \$54.95

GAME ROOM

Infocom - Most popular computer games

Cuthroats \$39.95

Deadline \$49.95

Enchanter \$39.95

Hitchhiker \$39.95

Infidel \$44.95

Planetfall \$39.95

Seastalker \$39.95

Sorcerer \$44.95

Starcross \$49.95

Suspect \$44.95

Suspended \$49.95

Wishbringer \$39.95

Witness \$39.95

Zork I \$39.95

Zork II \$44.95

Zork III \$44.95

Eliza: The pioneering artificial intelligence program. Eliza is a psychiatrist that carries on a conversation in plain English about anything you wish. Great to play alone or in a group.

Eliza (CP/M & MS-DOS) \$24.95

Adventure: Explore the dangerous Colossal Cave for treasures. Endure mystical spells and overcome adversaries. The only original uncut version.

Adventure (CP/M & MS-DOS) \$19.95

Airport: You are an air traffic controller and your radar screen is filled with aircraft under your guidance. See how long you can last without cracking. Tougher than the real thing!

Airport (CP/M) \$19.95

MyChess: This award-winning world class chess program features nine skill levels with over 850 opening moves. Prints moves and saves-game in progress.

MyChess (CP/M & MS-DOS) \$34.95

COOKS CORNER SIZE

Nutrition Profile: Take advantage of this personalized diet analysis. Written by an M.D., this program instantly analyzes your total dietary habits and nutritional intake. Keep track of your vitamins, minerals and cholesterol and more! Maximize your athletic performance. Maintain your optimum body weight. A complete nutrition helper!

Nutrition Profile (CP/M) \$49.95

MyDiet: Create your own personal nutritional profile that will help you derive the maximum benefit out of the foods you eat. MyDiet is designed for the professional nutritionist, but is easy to use. Compares to programs costing hundreds of dollars!

MyDiet (MS-DOS) \$49.95

Computer Chef - #1 in the Series: The computerized cookbook for food lovers. Contains a database of almost 100 recipes with space to add your own. Auto scale ingredient quantities, find recipes by key words or type of ingredients you want to use, then display or print your selection.

Computer Chef (CP/M & MS-DOS) \$29.95

What's for Dinner - #2 in the Series: 200 main dish and dessert recipes. Requires Computer Chef program (not included).

What's for Dinner (CP/M & MS-DOS) \$19.95

The Best of Wok Talk - #3 in the Series: Exotic Chinese cooking. Over 100 recipes from China. Includes Computer Chef program.

The Best of Wok Talk (CP/M & MS-DOS) \$29.95

HOME & BUSINESS CENTER

Checks & Balances version 3.4: A complete personal checking program or business register. 3.4 is a complete package that includes checkwriter and database. It is easy to learn and use with new features, including more types of reports. An excellent money manager!

Checks & Balances \$74.95

Rembrandt Ver. 3.0: The most popular graphics program for the Kaypro computer. Supports most dot matrix printers.

Rembrandt (CP/M) \$79.95

WRITERS WORKSHOP

Feature Format: A Scriptwriter's key redefinition program for WordStar. Feature Format outperforms other competitive programs in speed and function. Assign up to 4 keys to a definition. FF saves key definition to disk for later use, and much more.

Feature Format (CP/M) \$79.95

Punctuation & Style: Improves your writing by catching unbalanced quotes, parentheses and brackets, improper abbreviations, capitalization, sentence structure, much more. It's like having your own copy editor!

Punctuation & Style (CP/M & MS-DOS) \$125.00

Thesaurus: This powerful 90,000 word Thesaurus allows you to select the best word for the application. Works inside WordStar for greater ease of use. Instantly searches its dictionary, then displays synonyms, and automatically deletes the "wrong" word and replaces it with the "right" word. Requires 380K disk storage.

Word Finder (CP/M & MS-DOS) \$79.95

Wordpatch: Print files with tiny, compressed, wide, or wide compressed type faces, 5 sizes of italic, real superscripts and controls to learn. Supports most popular dot matrix printers. A must for WordStar users!

Wordpatch (CP/M & MS-DOS) \$49.95

The Word Plus: The ultimate spelling checker. Not only finds misspelled words but shows you correct spelling options, shows the word in context and much more. This program is bundled with all 8-bit Kaypro computers. A must for Kaypro 16 users!

The Word Plus (MS-DOS) \$150.00

SCHOOL HOUSE SIZE

Typing Tutor: Comprehensive program for use in teaching beginning skills or improving speed and accuracy. Not a simple minded drill this program takes you proper finger placement, basic thru advanced drills using "real world" text examples for both the main keyboard and the numeric keypad.

Keyboard - The computer Typing Tutorial (CP/M) \$34.95

Call for information on RSI educational software.

HARDWARE & SUPPLIES

Diskettes, Double Density:

Maxell package of 10 with storage box.	3M box of 10
Single Sided \$19.95	Single Sided \$22.95
Double Sided \$23.95	Double Sided \$26.95

Economy Diskettes: package of 25 including tyvek sleeves.

Single Sided \$29.50
Double Sided \$31.25

Call or write for our FREE catalog.

All items are warranted for 90 days. 30 day money back guarantee if not completely satisfied. Money back guarantee for software applies only if diskette seal is intact. VISA and MasterCard are welcome. Please add \$2.00 freight per total order (additional freight on monitors and carrying cases) and \$2.00 for COD orders. California residents please add 6% sales tax. Prices, availability and specifications subject to change without notice.

CALL TODAY **National** (800) 821-8778
California (800) 521-7182

Hours: Mon - Fri 8 am - 5 pm PDT
DEALER INQUIRIES WELCOME.



advent
products inc.

3154-F E. La Palma Ave.
Anaheim, CA 92806
(714) 630-0446

Disk Drive Diagnostics

Anticipating diskaster

by Pieter Burggraaf

I learned the hard way, but you don't have to. Faulty performance on drive A left my Kaypro useless. While the details of my problem are not important, the lesson I learned is.

The inherent reliability of computers lies in solid-state electronics, the seemingly motionless world of electrons inside silicon chips. Disk drives, on the other hand, are electromechanical devices subject to wear and tear. Drives are vulnerable to mechanical problems, but we seldom think about preventive measures or adjustments.

What I've learned about software that anticipates disk drive problems could be your gain. This software is different from any you have ever bought. You don't play with it or write with it or calculate with it; it is not "productive." But it is useful to a wide range of Kaypro users, from businessperson to maintenance technician. Disk drive diagnostic software is best used to provide a baseline (point of reference) when your drives are performing well. Then, the real value will come from monitoring your drives over a period of time and comparing test results with the baseline.

Few telltale signs

Your operating system and the disk controller chip do a good deal to overcome drive problems. When disk access falters, repeated retries (five or more times) are automatically attempted. If a retry is successful, you never know that a problem, which could indicate impending drive failure, existed.

Some system error messages (i.e., BDOS ERROR On d: Bad Sector) can also be early warnings. Have you ever experienced difficulty reading disks swapped between your two drives or between compatible Kaypros? Such a problem may be a message.

The fact is, though, we all take for granted the continued utility of our computers; we easily dismiss intermittent "early warnings" as temporary glitches. We don't see them as warnings, only minor frustrations.

How can you check the performance of your disk

drives? Browsing through *PROFILES*, perhaps you have noted disk drive diagnostic software from J&M Systems Ltd., Sheepshead Software, and Micro Cornucopia. The purpose of drive diagnostics software is to test your drives and diagnose problems. That way you can take preventive steps before a problem occurs.

Drive mechanics

Software from J&M Systems and Sheepshead Software are mechanical alignment tests for Kaypro disk drives. Both these packages use the Kaypro to read a special Dyan disk, the Digital Diagnostic Diskette (DDD), which is specifically written for disk drive analysis.

A basic understanding of disk drive mechanics and the special format of the DDD will help you see how the J&M and Sheepshead software work.

A magnetic pickup in the read/write head of your disk drive writes and reads a 12-mil-wide swath on a floppy disk. When formatting double-density drives, this 12-mil swath, or track, is repeated, equally spaced, 40 times across the surface of the rotating disk.

Ideally, every time the read/write head returns to a track, it should center on the previously written data. The head should also be perpendicular to the track centerline. (See Figure 1 on page 69.)

The accuracy of read and write operations is also a function of the rotational speed of the disk and the time it takes to move the head to a given track.

Drive performance can be defined with five factors, which can be checked with the kits from J&M or Sheepshead. These five specifications are:

Radial alignment—head-to-track centering, measured in mils offset.

Hysteresis—the difference between radial alignment measurements of a track accessed from one direction (i.e., moving toward the hub), then the other (i.e., moving away from the hub).

Spindle eccentricity—deviation of data tracks from concentric rotation, measured in mils (i.e., the tracks should rotate as concentric circles).

Head azimuth—sensor-to-track perpendicularity,

measured in minutes (angular) offset.

Index hole timing—elapsed time from leading edge of index hole to the first sector address, measured in microseconds.

Spindle speed—the speed of disk rotation in revolutions per minute.

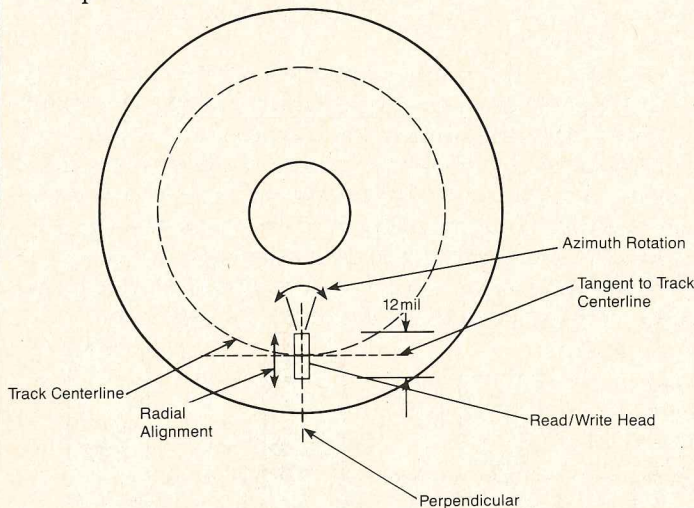

1. The most crucial mechanical-alignment specifications are the radial and azimuth alignment of the read/write head to formatted tracks on a floppy disk.

Dysan's DDD

Think of the DDD as a standard-of-measurement disk. First, blank disks destined to become DDDs are meticulously screened for physical and electrical quality. Then, each DDD is written with two timing tracks (3 & 36). These contain precisely written data that can be used to test index hole timing and rotational speed.

In addition, every DDD is written with a variety of intentionally misaligned tracks of data, called progressive, alternate and azimuth offsets (see Figures 2a, 2b, 2c on page 70). Never try to copy the DDD—it's a waste of time. You cannot duplicate the intentional misalignments, which makes any copy totally useless.

Progressive offset

Each DDD has six "progressive offset" tracks (0, 5, 16, 19, 30 and 39). On these tracks, successive data fields are displaced progressively 1 mil further from the track centerline, alternating from one side to the other (see Figure 2a).

When a head reads a progressive-offset track, it eventually reaches a point where the magnetic signal of a displaced data field is too weak to read. Ideally, the first two fields a head fails to read should be equally displaced on either side of the track centerline. Conversely, a misaligned head will read more fields to one side of the centerline than it will to the other side.

Progressive offset is used to measure radial alignment and hysteresis. Radial alignment is a crucial specification for disk drives; most problems encountered involve radial alignment. Six tracks of progressive offset are provided so radial alignment can be

checked at outer, middle and inner positions. The consistency of radial alignment across these tracks (and from one side of the disk to the other) is a measure of head positioning linearity.

Alternate offset

The DDD has three tracks (21, 24 and 27) with "alternate offset." Each of these tracks is composed of equally displaced (7-, 8- and 9-mil, respectively) alternate data fields (Figure 2b).

Alternate offset data tracks are used to measure any eccentricity in track rotation. Eccentricity is caused by a bad drive spindle or faulty clamping of a floppy disk in the drive hub.

Azimuth offset

On the one "azimuth offset" track of the DDD, data is written with progressively greater azimuthal displacement. (A head that is perpendicular to the direction of track rotation is at zero degrees azimuth, the ideal alignment.) The azimuthal offsets are placed alternately clockwise and counterclockwise (Figure 2c).

If a head is properly set it will eventually fail to read data fields that are equally rotated clockwise and counterclockwise. Conversely, the more the sensor is out of azimuth alignment, the more it will pick up data fields skewed in one direction of azimuthal rotation.

All other tracks on the DDD are blank for spacing between the offset tracks or for user data. The user tracks cannot be used with CP/M because the disk directory would overwrite DDD test tracks. DDDs do not have a write enable notch, so you couldn't write to it if you tried.

The translators

Dysan's DDD is useless to Kaypro users without the special software from either J&M Systems or Sheeps-head Software. The software packages from both these vendors come with DDD disks, ample written instructions, and second disks of special test programs to read the DDD. These programs display the mechanical condition of a drive, in graphic form, on your Kaypro screen.

Other software for drive diagnostics is used for analog testing. Analog testing involves complex electronic instrumentation, which should only be used by accomplished technicians in fully equipped repair shops.

J&M's Memory Minder

The Memory Minder includes two test programs—one for early Kaypro II and 4 models, and one for 1984 Kaypro 2, 4 and 10 (floppy drive only) models.

Assuming that you know how to PIP and execute programs from the command level (A>), the J&M programs are almost foolproof. A main menu leads to single-screen menus for each of eight test routines. All menu commands, including those to select drive, head and track, are single-key entries.

Test results are displayed in nicely conceived graphics, several presenting test results statistically (Figure 3), regardless of your Kaypro's graphics capability.

Two error messages tell you if the test disk cannot be read or if the DDD is not in the drive being tested. (With one DDD disk, you must switch it between the drives you are testing.)

An experienced Kaypro user might skip the manual initially. However, it is required reading for proper interpretation of test graphics.

Memory Minder gives you two levels of testing. The "Quick Test" is a program-controlled run through spindle speed, index hole timing, spindle eccentricity on three tracks, radial alignment on three tracks, (head) azimuth rotation and hysteresis. Each test is rated "good," "marginal" or "poor." Results of poor or marginal indicate a need for in-depth testing.

2. The Digital Diagnostics Disk (DDD) includes intentionally misaligned tracks of data.

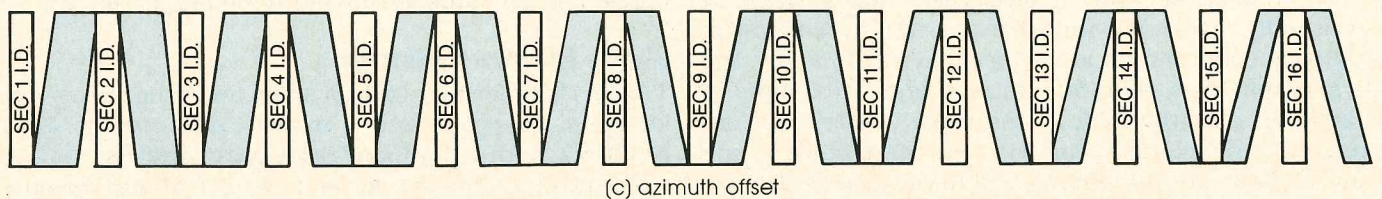
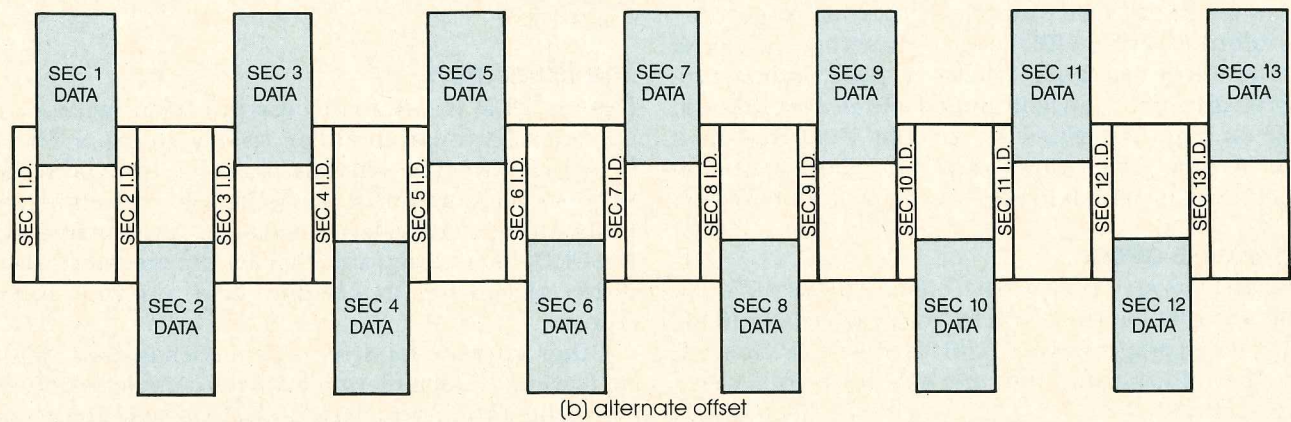
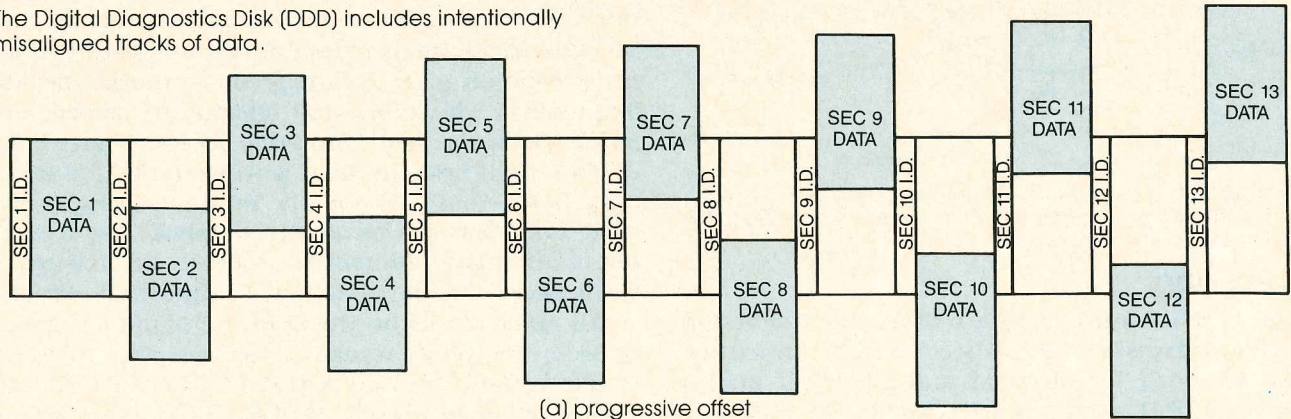

Memory Minder has seven in-depth tests: clamping (spindle eccentricity), spindle speed, index hole timing, alignment sensitivity (radial alignment displayed statistically), head alignment (radial align-

ment, analog display), direction seek (hysteresis) and head rotation (azimuth). (Parenthetical notes equate software vendors' tests with standard drive specifications described in this article.)

For each of these tests, the manual briefly discusses general techniques of adjustment and repair. The manual is not intended to give full instructions for do-it-yourself repair.

I found a few minor shortcomings in the Memory Minder package. The manual interchanges the terms "MMK," Memory Minder for Kaypros, and "DDA," an abbreviation for the same program under a previous name. This is easily overcome once you make the connection. Another minor problem, a "status" display, apparently a hexadecimal code relating to the status of the disk controller, is not fully explained. However, the code is not needed to successfully run the tests.

Sheepshead diagnostic kit

Sheepshead's test disk has programs for all Kaypro models except the Robie. This includes separate programs for old Kaypro IIs and 4s, for old Kaypro 10s

(floppy drive only) and for all 1984 Kaypro models (those with 4-MHz microprocessors). Also included are drive-diagnostic programs for some modified Kaypro IIs and 4s (i.e., 5-MHz speed-up kits or 96TPI drives).

While each program can be run from the command level, programs are also tied together through a menu. Another master program ties together all test programs for 1984 model Kaypros. And a separate help file provides information on test interpretation. Once you're at a menu, all options are single-key entries.

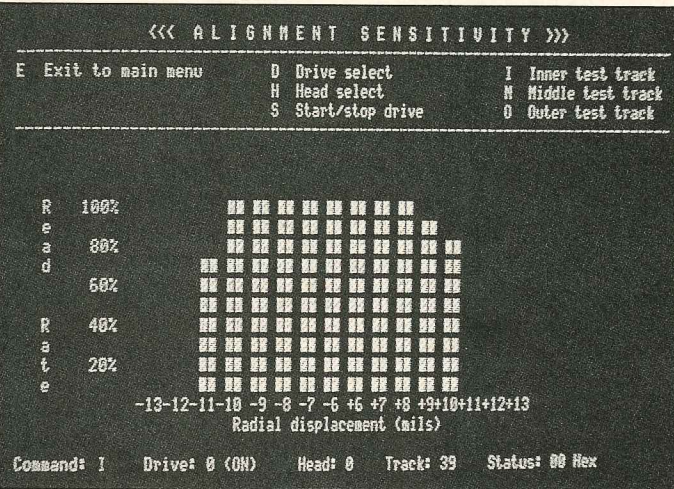

3. Shown is the result of a Memory Minder test for radial alignment to track 39, which displays the statistical percentage of successful reads of progressive offset fields.

Sheepshead's package also includes three special test programs not used with the DDD. R/WTEST.COM provides an endless reading-and-writing exercise to run a Kaypro through its paces (a burn-in). CRT.COM fills a Kaypro screen with characters, providing a quality check. And MEMORY.COM sequentially checks all memory locations.

The manual provided with the Sheepshead programs is extensive. First, it presents a tutorial on drive testing using programs for clamp center (spindle eccentricity), radial (alignment), (head) azimuth, (spindle) speed, position error (hysteresis) and index (hole) timing. Displays of test results are either digital or analog (Figure 4).

The manual also includes discussion, tips and photographs of disk drive repair, centered on Tandon drives (the original drive used in Kaypros). For example, a savvy Kaypro user can find out how drive B can be used to boot CP/M. (Testing with the DDD is not possible unless one drive is working.)

Be cautious, however. The manual is not a complete guide to drive repair and should not be treated as such. It assumes a user has previous experience repairing electromechanical components. Anyone working on a drive will need a service manual for that specific drive. (A service manual for the Tandon drive can be ordered with the Sheepshead package.)

Shortcomings in the Sheepshead software are carried through into the manual. Revisions have not kept

up with the broad range of programs available on the test disk (the manual comes with an addendum that must be read first). In addition, the manual is plagued with disconcerting typos.

Micro C Disk K18

The Micro Cornucopia drive diagnostic software is a write-read-verify test. Its DISKTST.COM programs for Kaypro II and 4, and the floppy drive of Kaypro 10 are write, read and verify routines. You can select the tracks to test and the data to write, and choose between write-read, read only, write only and multiple passes across the disk.

DISKTST.DOC, the document file that comes with Micro Cornucopia's diagnostic diskette, gives a summary of DISKTST's usefulness. Some of what this file has to say is:

"The program does not exhaustively check out the disk drive. . . errors . . . must be interpreted with care. Intermittent errors occurring throughout a broad range of disk addresses probably indicate a problem with the disk drive unit. Errors . . . at consistent addresses within adjacent tracks may result from a . . . damaged . . . disk. Error free execution of the test . . . indicates an intact and usable diskette, and also is fairly good evidence of proper operation of your disk drive. . . the program is . . . insensitive to drive problems related to head movement . . ."

Complete drive testing, therefore, should include evaluation of mechanical alignment. (Note: "PIP

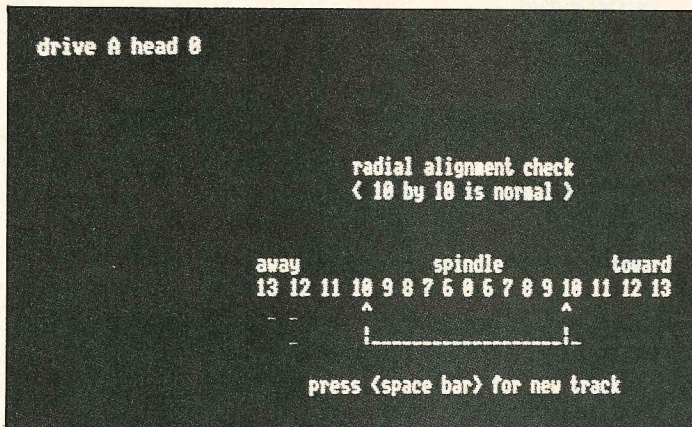

4. Shown is the result, displayed on an analog scale, of Sheepshead Software's test of radial alignment to track 39.

A:=B:*.*[v]" of a full disk is also a write-read-verify test.) The real value of the Micro Cornucopia diagnostic disk is its memory test programs.

Value and caveats

Either the J&M or Sheepshead disk drive diagnostic package can help you monitor drive performance. But nothing is without its caveats.

First, this software will not make you a repair technician. (If you don't know where you can get your Kaypro

StatPac™

The World's Best
Micro Computer Based Statistical
Analysis Package

Forecast Plus™

Time Series Analysis Package

The Business Forecasting Tool
for the Non Statistician

Call For Free Comprehensive Brochures

1-800-328-4907

WALONICK ASSOCIATES

6500 Nicollet Ave. S. Minneapolis, MN 55423
(612) 866-9022

Find the right word

THE WORD FINDER

(Synonym Finder)



Multimate, Word Perfect

Improve your writing by finding the *perfect* word. Put your cursor on a word and call up a list of words with similar meaning. Pick one, and voila, your new word replaces your old word. No more fumbling for a book. It's so fast and easy you'll use it all the time. Special introductory offer, only **\$79.95!** (Regularly \$124.95.) Synonym Finder installs on most machines that run WordStar (3.3 or 3.0), Multimate, or Word Perfect. Specify word

proc., computer, operating system (MS/PC DOS or CP/M 80) and disk format. New database has 1/3 more words than Random House and uses 1/3 less disk space. Easy to install and operate. Highly rated by dozens of reviewers and users groups. \$2.50 shipping - NYS residents add sales tax. Okay! My check is enclosed for \$_____ (or charge my VISA/MC acct. #_____ expires _____ / _____).

Writing Consultants

Suite 342, 11 Creek Bend Drive - Fairport, NY 14450
Orders only: 800-828-6293 Info: 716-377-0130
dealers and distributors please call or write

DRIVE DIAGNOSTICS

repaired reliably, you'd better find out now before you're forced into a quick decision.) DDD-based software can help you anticipate problems before the drive fails. Then you can approach a repair technician with solid diagnostic data.

Second, be aware that the dimensions of floppy disks, including the DDD, are affected by temperature and humidity. For example, expansion caused by a temperature change of 20 degrees Fahrenheit can move the outer tracks up to 1 mil. High humidity can cause additional change in track location. So test your drives after your system has warmed up. And be sure that the DDD has time to adjust to the temperature inside the drive.

Third, any modifications that have been made to your Kaypro, particularly speed increases, can affect drive test results. Both spindle speed and index hole timing tests use the inherent timing of the micro-processor clock in your particular Kaypro. Any changes from what the Kaypro factory supplied could produce false test results.

Finally, you must realize that disk drive mechanical specifications are defined with a range of values and interpretation must be tempered with practical results. Consistent test results are, most often, better than chasing a dead-on specification.

Pieter Burggraaf, a two-year Kaypro user, is senior editor of Semiconductor International, a trade magazine of Cahners Publishing Co. He lives in Phoenix, Arizona.

Quick Reference Summary

Product name: Disk Drive Diagnostic Kit

Manufacturer: Sheepshead Software

P.O. Box 486

Boonville, CA 95415

Hardware needed: Will test older Kaypro II, 4 or 10, or 1984 Kaypro 2, 4 or 10.

List price: \$88.00 (or \$99.00 with Tandon service manual).

Product name: Memory Minder CP/M

Manufacturer: J&M Systems

15100-A Central Ave. SE

Albuquerque, NM 87123

Hardware needed: Will test older Kaypro II, 4 or 10, or 1984 Kaypro 2, 4 or 10.

List price: \$99.00

Product name: Micro C Kaypro Disk K18

Manufacturer: Micro Cornucopia

P.O. Box 223

Bend, OR 97709

Hardware needed: Kaypro II, 2, 4 or 10.

List price: \$12

"Out keys the competition" even more!

"XtraKey is the best (keyboard) translation program I've seen . . ."—Philip Bond, *Micro Cornucopia*

"Ingenious . . . If saving large blocks of time . . . is important to you, I wouldn't hesitate to get this program."—Brock Meeks, *Computer News*



Programs like WordStar, dBASE II and hundreds of others are a whole lot easier and faster to use when XtraKey is around. The secret is XtraKey's ability to reduce text or long command sequences (whatever you hate typing over and over again) to just one or two key-strokes! Close a letter or insert boilerplate in split-seconds. Change margins and tabs instantly. Log onto bulletin boards at the touch of a key. Create database "macros."

Unlike other "key" programs (the "smarts", "magics", "kwiks", etc.), XtraKey can redefine any key on your Kaypro's keyboard including keypad keys . . . with no limit on definition lengths. Plus our advanced XShift feature lets keys have up to 16 meanings without losing their normal functions. Use, change or make up new definitions anytime; no need to exit to CP/M. And, if you make a mistake entering a definition, XtraKey's backspace feature lets you correct it.

You can even access your printer or video display. Address an envelope while editing a document. Change from regular to compressed type while working on a spreadsheet. Or call up your own custom help or menu screens.

No other program can match XtraKey's list of features! Built-in print screen (screen dump) gives instant hard copy of your Kaypro's current display. Batch processing. Automatic definition file loading. Input pause. Definition chaining. Printer redirection. Clear screen and more. Even with all its capabilities, XtraKey is still easy-to-use and learn. Includes new 80-page manual, quick reference card, and predefined function sets for many popular programs. Still only \$49.95.

The New XtraKey

Trademarks: XtraKey, XScreen and XShift — Xpert Software; dBASE II — Ashton-Tate; WordStar — MicroPro International; Kaypro — Kaypro Corp.; CP/M — Digital Research

XScreen!

"It works and it's solid. . . well worth it . . ." Tom Enright, *Technical Editor, Profiles*

XScreen makes instant copies of your Kaypro's current screen display on your printer OR allows you to save screen copies in standard word processing text files. Works any time, even while running your favorite program.

Copy menus, spreadsheet totals, bulletin board messages, etc. Then use your word processor to insert screen copies directly into a document where they can be edited! WordStar users can even tell XScreen to eliminate the top rows and far right columns for instant letters and envelopes.

XScreen is easy-to-use and requires no installation. **Only \$24.95.** See special offer below.

ORDERING INFORMATION

XtraKey and XScreen will run on all Kaypros except the 16 and 286i. To order XtraKey, send check or money order for \$49.95 plus \$3.00 shipping (U.S. & Canada). To order XScreen, send \$24.95 plus \$2.00 shipping. **SPECIAL OFFER** — Order both XtraKey and XScreen for only \$59.95 plus \$3.00 shipping. California residents MUST add 6% sales tax. Inquire on foreign orders. Specify Kaypro II (SS/DD) or Kaypro 4 (DS/DD) disk format. VISA and MasterCard accepted (provide card number and expiration date). All orders please include telephone number.

Xpert Software

8865 Polland Ave. • San Diego, CA 92123
(619) 268-0112

LOANTRK® AND TIMETRK®

GO "HAND AND HAND" WITH YOUR SYSTEM

LOANTRK®
MENU DRIVEN, NEW, FAST, the help you need to deal with loans, leases, and almost any question about borrowing or the value of money. Computes APR, Payments, length of loan, amount of loan, future value of money and will print a loan repayment schedule. Whether you are a professional money manager, accountant, realtor or just someone who needs financial information — you need LOANTRK. \$49.95 + \$3.05 shipping & handling.

TIMETRK®
The law may change from time-to-time, but the IRS will always be there, AND they will want to see your records to substantiate your deductions. USE TIMETRK to keep a record of your computer usage. Provides total use, business use, both as totals and business use as a percentage of total. \$29.95 + \$3.05 shipping & handling.

FINANCIAL TRACK SYSTEMS INC.
9208 GUTIERREZ NE
ALBUQUERQUE, NM 87111

(505) 243-8975

7 DAY/24 HOUR ANSWERING SERVICE

VISA AND MASTERCARD CHECKS, MONEY ORDERS
DEALER INQUIRIES WELCOME

BARGAIN CORNER

Get both
LOANTRK & TIMETRK
FOR

\$69.95

PLUS \$3.05 shipping.

Version 4.0 with
Exciting New Features!

Free Filer

The "Un-Database" from Telion Software

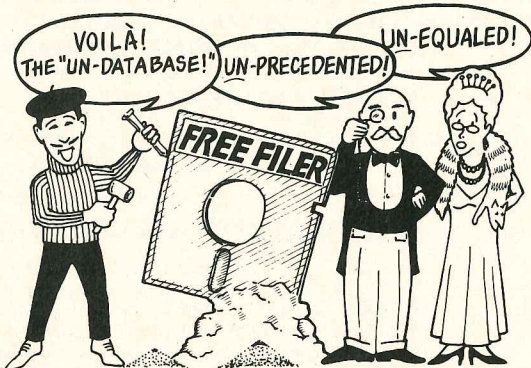

Database programs make you organize information into a form. That's fine for an address list where every entry contains the same old boring things. But how do you "database" your free-form text files, like novels, business letters, screenplays, annotated bibliographies, personal correspondence or client case histories? With a database program you're just plain out of luck!

Now Free Filer lets you keep track of your words like you do your lists. That's why we call Free Filer the "un-database."

How does FREE FILER do it? Free Filer divides your diskette into parcels of information, much like index cards. It will segment your text files into paragraph parcels automatically. Or you can specify other data parcels yourself.

You can search, alphabetically sort, and print each parcel effortlessly. You can even combine parcels to create a new card. Free Filer can search all or some of your files on disk, going through them one by one. And if you have lots of files, that can save you a bundle of time.

And it's fast. Free Filer can blitz through a 55K file in less than 25 seconds.

"I am taken at the program's speed and simplicity. I would recommend it for everyone - it's another tool to make your computer more powerful and you more efficient." - Peter A McWilliams, author of *The Personal Computer Book*.

"Free Filer is one of those wonderful little general-purpose text utilities that simplify life with computers. Recommended." - Jerry Pournelle, *Byte Magazine*.

Free Filer is directly available from Telion Software for \$49.95 in most popular CP/M and MS-DOS formats, including Kaypro, Morrow, Apple CP/M and IBM PC.

Now shipping 4.0 with "AND," "OR," and "NOT," (boolean) searching with even faster searching and sorting performance. Calif. residents add 6%. Credit card add 5%. Include \$2.00 shipping and handling.

TELION
software

P.O. Box 1464
La Mirada, CA 90637-1464
Phone 213-547-9673

SAT

(continued from page 37)

20 questions per test, you know all its answers.

While neither one is perfect, you could combine the two to make the ultimate study tool. Too bad I just graduated and had my own trial by SAT two years ago. With study programs like these, I could've been at MIT by now. □

Benson Wong is a recent graduate of Patrick Henry High School in San Diego, California, where he was an advanced computer science student. He was assisted in the preparation of this article by San Diego writer Mary DeDanan.

Quick Reference Summary

Product Name: College Board SAT Preparation Series

Uses: practice for taking the Scholastic Aptitude Test

Audience: High school students or anyone preparing to take the SAT.

Noteworthy features: Easy to load, choice of number of questions to be answered, scoring similar to SAT's, determines problem areas that need study, bonus and limited warranty for improved scores.

Manufacturer: Krell Software Corporation

1320 Stony Brook Road

Stony Brook, NY 11790

(516) 751-5139

Hardware needed: Kaypro 2, 4, 10

List price: \$299.95

Product name: The Coach; also called College Board Score Builder

Uses: same as above

Audience: same as above

Noteworthy features: answers shown with questions, reading comprehension sections shown onscreen, diagrams and hints provided in math section, word definitions and explanations of analogies provided in verbal section.

Manufacturer: Resource Software International

330 New Brunswick Ave.

Fords, NJ 08863

(201) 738-8500

Hardware needed: same as above

List price: \$34.95 □



"Yeah, my mom is afraid of computers. Why do you ask?"

Trantor Hard Disk SUMMER SALE!

11 Meg	SAVE \$100!	Only \$1195.
23 Meg	SAVE \$200!	Only \$1595.
35 Meg	SAVE \$300!	Only \$2095.
47 Meg	SAVE \$400!	Only \$2595.

We've Got Your NUMBER!

Complete with

- Bios
- Format
- DiskMgr
- Arkive
- Configuration
- Head Positioning
- 6 Month Warranty
- And . . .

SuperCalc2

from Sorcim/IUS, the world's best electronic spreadsheet, is included FREE with all Trantor Hard Disks.

Extremely fast and powerful, SuperCalc2 is THE big step up in spreadsheet capability.

And, if you're wondering about learning "one more program," SuperCalc2's simple command language is so easy to learn you'll be building your own super spreadsheets right away.

Now includes
MENUPAC
Create your own Menu-linked
applications as easy as using
WordStar!
FREE with every Trantor

WestWind

1690 65th Street Emeryville, CA 94608 (415) 652-3222
Telex 756329 (DRIVE C UD), WU EASYLINK 62533500.

FREE CATALOG

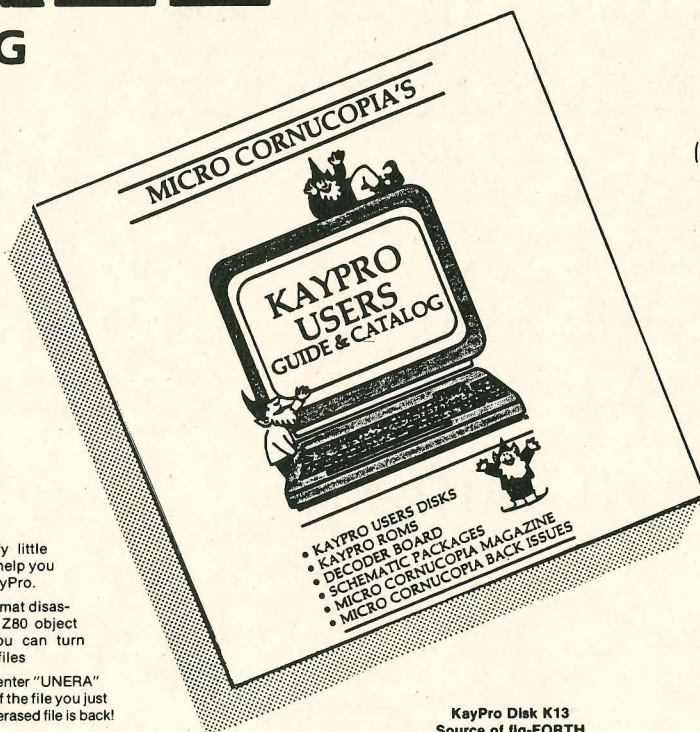

KayPro Disk K1 Modem software

KayPro Disk K2 Utilities

Really oodles of spiffy little (and big) programs to help you get full use of your KayPro.

DASM: A true Zilog format disassembler for 8080 and Z80 object (.COM) files. Now you can turn .COM files into .MAC files

UNERA.COM: Simply enter "UNERA" followed by the name of the file you just erased and presto, the erased file is back! A lifesaver!

FINDB54.COM: Checks an entire disk, reports bad sectors, and then creates a special file containing those sectors. You save a bundle on disks.

CAT2: This is a group of programs which create and maintain a single directory of all the programs you have on all your disks. Even keeps track of which programs are backed up and which aren't.

UNSPPOOL.COM: Use your KayPro II and print files at the same time. Doesn't slow down system response!

DUMPX, DU-77, COMPARE, SUPERSUB, FORMFEED, DIR-DUMP, . . . and all have documentation on disk.

KayPro Disk K3 Games

KayPro Disk K4 Adventure

This disk contains one 191K game. Adventure. ADV.COM: This is the latest, greatest, most cussed adventure ever devised by half-mortals. This is the 550-point version so the cave is greatly expanded and the creatures are much smarter.

KayPro Disk K5 MX-80 Graphics

KayPro Disk K6 Word Processing Utilities

KayPro Disk K7 Small C Version 2 Compiler

KayPro Disk K8 Small C Version 2 Source

KayPro Disk K9 ZCPR

KayPro Disk K10 Assemblers

KayPro Disk K11 Library & Checkbook Programs

CHECKS: This has been a very popular group of programs. Categorizes checks so you can keep track of which are tax deductible and which get charged to which projects. Includes source and example check files. Very powerful.

LIBR: This is a complete set of library routines which let you group files into a single file called a library. Then CP/M sees them as a single file, but with the library routines, you can list them out separately, run them separately, or divide them up again. Almost like a unix environment.

DISPLAY, VLIST, PGLST: Additional screen and print utilities.

KayPro Disk K12 FORTH

- KAYPRO USERS DISKS
- KAYPRO ROMS
- DECODER BOARD
- SCHEMATIC PACKAGES
- MICRO CORNUCOPIA MAGAZINE
- MICRO CORNUCOPIA BACK ISSUES

KayPro Disk K13 Source of flg-FORTH

KayPro Disk K14 Smartmodem Program

KayPro Disk K15 Hard Disk Utilities

KayPro Disk K16 Pascal Compiler

KayPro Disk K17 Z80 Tools

KayPro Disk K18 System Diagnosis

Just as we finished editing the routines on this disk, we received a copy of KayPro's diagnostic disk. The memory test and drive exercise routines on this disk are more powerful than KayPro's versions. (Plus, it's only \$12) Setup for KayPro II & 4.

KayPro Disk K19 Prowriter Graphics

KayPro Disk K20 Color Graphics Routines

KayPro Disk K21 SBASIC Routines & Screen Dump

SBASIC: Finally a disk of SBASIC software. There are some good examples of structured programming on this disk (including one program written both ways so you can see the difference).

SCREEN DUMP: This is a screen dump for all KayPro's new and old. You can buy a similar package elsewhere for \$60.

KayPro Disk K22 ZCPR (Again)

This disk is filled with ZCPR files. You get ZCPR for the KayPro II, KayPro 4, and the KayPro 10. This version is fixed so that you can pass control characters from the keyboard to the printer, and you can choose to have it recognize the semi-colon for drive select (as well as the colon). So you can enter "B;" or "B:" to select drive B. Super neat!

ZCPR, for those of you who don't know, makes CP/M a lot friendlier. It searches drive A for any .COM file it doesn't find on the current drive, the TYPE command scrolls text 24 lines at a time, and a new LIST command outputs a file to the printer.

KayPro Disk K23 Fast Terminal Software & New BYE

KayPro Disk K24 MBASIC Games & Keyboard Translator

We sifted through many, many games before coming up with these gems. All will work on any KayPro and all come in MBASIC source.

USOPEN shows you the fairway on the screen. You select the club and direction for each stroke. After you reach the green

Write or call
for a free catalog
(also included with each order from)

MICRO CORNUCOPIA

P.O. Box 223
Bend, OR 97709



(503) 382-5060

9-5 PST Monday-Friday

DISK \$12.00 ea.
postage paid



KAYPRO USERS DISKS for Kaypro II, 4 and 10

the display shifts to show details of the green and flag. For one to four players.

DUCK is an offshoot of aliens (pardon the pun). Hunter tries to shoot down the ducks while ducks try to bomb the hunter. (Much fairer than real life.)

CASTLE is an adventure in which you select your attributes (strength, dexterity, and intelligence), and you get to purchase arms and protection. Great documentation and a very interesting game.

KSTROKES is a keyboard translator similar to Smartkey. Bill Forbes did an excellent job creating this program. You can create and save translation files on disk. The program even includes a table which generates WordStar commands from the KayPro's keypad! You can define 8 keystrokes at up to 63 characters each.

KayPro Disk K25 Z80 Macro Assembler

KayPro Disk K26 EPROM Programmer & Character Editor

KayPro Disk K27 Typing Tutor

A complete typing tutor for beginners and experts. Written in Australia, it comes complete with source. This was customized for KayPro II, 4 and 10 by Barry Cole of WLAKUG.

The documentation says you can learn to touch type in 8 hours (probably a little longer for mortals).

KayPro Disk K28 Modem 730

KayPro Disk K29 Turbo Pascal Games 1 With Source

KayPro Disk K30 Turbo Pascal Games II With Source

KayPro Disk K31 Turbo Bulletin Board Complete Bulletin Board Package for only \$12

KayPro Disk K32 Forth-83 Much Fancier Forth

KayPro Disk K33

A super utilities disk containing:
NewSweep, Nulull, Superzap, & VDO-KP.

KayPro Disk K34

Five games plus source (mostly Turbo);
includes improved Othello and Eliza.

KayPro Disk K35

Small C Compiler & Source — Vers 2.1;
(Requires Microsoft's M80)

KayPro Disk K36

Small C Library of 100 Functions.

PRICELESS

MAGAZINE

Micro Cornucopia Magazine

Want to speed up your Kaypro? Want to find out what's going on under the Kaypro's hood? Want to know who's selling good products and providing good support (and who isn't)? Want to find really inexpensive software? Then you're in the right place.

Micro Cornucopia (Micro C) is the friendly journal for those of you who want to stay abreast of the latest information on Kaypros and other single board systems, or want to upgrade your Kaypro yourself without paying an arm and a leg. We have regular columns on Pascal, C, S-BASIC, FORTH as well as the popular "On Your Own" feature for those of you who plan to make the Kaypro your ticket to independence.

You can get all this and more when you order the special \$2.00 sample copy. In fact, you'll even find out how to turn a Kaypro II into a Kaypro 4 (or Kaypro 8).

Subscription Rates

1 yr. (6 issues - bulk rate)	\$16.00
1 yr. (6 issues - first class)	\$22.00
1 yr. (Canada & Mexico)	\$22.00
1 yr. (other foreign)	\$30.00



October 1984

No. 20

TABLE OF CONTENTS	
HSC 68000 Co-Processor	5
DynaDisk for the BBI	8
BBI: ETX/ACK Serial Print Driver	11
More I/O on the BBI	13
Parallel Printer on a BBI Sans S10	14
Pascal Procedures	16
Extended 8" Single Density	18
SBASIC Column	20
The Kaypro Column	22
Cheap and Dirty Talker for your Kaypro	26
The Slicer Column	30
FORTHwords	33
C'ing Clearly	38
Xerox 820 Column	44
SOG III	48
On Your Own	52
Technical Tips	62
	68

PRO-8 ROM PACKAGE

The PRO-8 package from Micro Cornucopia upgrades your Kaypro 4 (pre-84) to a Kaypro 8 with 784K bytes (96 directory entries) per Tandem 100-4 (or equivalent) quad-density drive. Plus, you can select your own cursor character (and change it at will).

The package includes the new PRO-8 monitor ROM, a disk of formatters & copiers, and printed instructions. (We even tell you how to turn your Kaypro II into a Kaypro 4.) All you add is one or two double-sided double-density (390K), or double-sided quad-density (784K) drives. You get over 1.5 Megabytes on a two-drive quad-density system!

This new system can read, write and format Kaypro II and Kaypro 4 disks as well as Kaypro 8 disks. And it recognizes each disk type automatically!

All this for only **149⁹⁵!**

Watch Micro Cornucopia for more Kaypro compatibles. Call or write for information on the other Kaypro II and 4 ROMS from Micro Cornucopia.

Schematic Packages

Finally, a complete schematic for your portable Kaypro, logically laid out on a single 24" by 36" sheet, plus a very complete illustrated Theory of Operation that's keyed to the schematic. You'll get detailed information on your processor board that's available nowhere else.

For instance, those of you with the 10 and new 84 systems get a thorough rundown on your video section complete with sample video control programs in assembly language and Pascal. Of course, all packages contain serial and parallel port details and programming examples as well as complete coverage of the processor, clock, I/O, and disk controller (information that is not even available in Kaypro's own Dealer Service Manual).

Kaypro Schematic Packages



Kaypro II & 4 (pre-84)	\$20
Kaypro 10 (pre-84)	\$20
Kaypro 84 series (II & 4)	\$20

All prices include postage.

Special Offer!

Your First Schematic Package (If you also order subscription) \$10

MICRO CORNUCOPIA ORDER FORM

Quantity	Description	Price	Total	NAME _____
	Subscription (1 year-6 issues) (See subscription rates above)			ADDRESS _____
	Kaypro Disks for 2, 4 & 10 — 5" SSDD #s	\$12		CITY _____
	Kaypro Catalog	FREE		STATE _____ ZIP _____
	Other Items:			Make check or money order payable to: Micro Cornucopia P.O. Box 223 • Bend, OR 97709
				Card No. _____ Exp. _____
				<input type="checkbox"/> VISA  <input type="checkbox"/> MasterCard 
				Signature _____
TOTAL ENCLOSED				

Prices include media, package,
1st Class Postage

Each course costs \$795 and is worth three credit hours. All online connect charges are included in the price of the course, and students receive unlimited online time when participating in a Connect Ed course.

You can enroll online via The Source (AAH298), MCI Mail (Connected Education), or EIES (Lev), or by calling Connect Ed's New York office.

Ancient online educator

Plato is the name of Control Data Corporation's (CDC) computer-based education system. Online since 1976, Plato is the oldest of all online education systems.

Until recently Plato was available only to businesses, universities and others who could afford it (original costs for 24-hour access to Plato included leasing a terminal for \$1,000 a month). By moving Plato into the "public domain" via its "Homelink" network, CDC has made it possible for the home computer user to take advantage of what Plato has to offer.

Kaypro 16 owners can use their graphics capabilities to produce high-resolution on-screen graphs and charts. For a \$49.95 communications package, a \$25 annual fee and \$7.75 an hour connect time, the cost of CDC's Homelink is comparable to the other major information utilities.

The courses offered on Plato read like a catalog from a university. "Astronomy: Constellation Study," "Aviation: Ground school," "Chemistry: Naming Acids and Bases," "Language: Basic English Grammar" (as if your eighth grade English teacher Ms. Grundy didn't teach you enough), and "Math: Solving Quadratic Equations." Students begin at their own level of knowledge and proceed at their own pace.

Plato is also offered through local universities. To find out if a nearby university offers Plato courses, check with the Independent Studies office. Credit for Plato courses varies, and credits are

transferable at the discretion of the receiving institution.

Student body benefits

What type of person does this "high-tech preppie" education appeal to (besides high-tech preppies?) The possibilities are simply tremendous.

The handicapped community comes instantly to mind. Anyone homebound can benefit from an electronic classroom. Other likely candidates include single parents who want to go back to school, professionals with little free time who are seeking advanced degrees, and procrastinators (like me) who

the professor in a traditional face-to-face classroom setting are more inclined to do so from the comfort of their computer keyboard." (Those who have agonized over raising their hands in a classroom can relate to that statement.)

Open and closed book

Will online education replace more traditional education? I doubt it. (Besides, I hear frat parties lose something in the phosphor.)

Though I can't vouch for the quality or viability of these programs (only your college registrar knows for sure), this new breed of education does offer an exciting

The Harvard Business Review placed WBSI in the top five among management programs.

never finished that last semester but plan to go back to school "real soon now."

But how good is electronic education? Some consider it nothing more than a glorified correspondence course.

So?

Tests show that it is possible to achieve more and retain more with correspondence courses than with regular classes. Monty McMahon, director of Independent Studies at the University of Nebraska, says that an online course can be better designed than a traditional course. McMahon says an online course tends to be better organized because the entire course is in printed form, and it allows students the luxury of examining it in its entirety from day one.

Levinson says: "Students get a lot more interaction from an online course. Student and professor can interact on a private level—something that rarely happens in a classroom of 200 people. Because an online course has a certain built-in ambiguity, students who might not participate or question

alternative to a large part of the population.

Now if you'll excuse me . . . I'm late for class. □

Telelearning Systems
San Francisco, CA
In Calif. (800) 455-3276
Outside Calif. (800) 225-3276

Western Behavioral Sciences Institute
La Jolla, CA
(619) 459-3811

Connected Education
Bronx, New York
(212) 548-0435

Intercultural Network
University of California, San Diego
La Jolla, CA
(619) 452-2059

National Education Corporation
Newport Beach, CA
(714) 955-9400

Plato's Homelink Network
Control Data Corporation
(800) 328-7104

mands?"). You divide that into smaller pieces (movement commands, editing commands, etc.), and those pieces into still smaller ones, refining and extending your outline, focusing on each small section, until you have everything worked out in detail. As you work, you use the viewing commands to see how your current section fits into the overall scheme, and you use the editing commands to rearrange things as new ideas crop up. This approach suits TOUR20 very well and can turn huge projects into a series of manageable steps.

- *Brainstorming.* You can also use the brainstorming approach. Here you put TOUR20 into its APPEND mode and bang in a series of ideas, without regard to their relationship to each other or their level of generality. In the process, you create a list of ideas, questions, and odd bits of information. Then, you go back over your list, using CUT, PASTE, and other editing commands to discard the junk and to group related details under more general ideas. Your structure and your controlling idea grow out of the details as you fight to get them in order. This approach also works but doesn't go as smoothly as the top-down approach, largely because it's inherently messier, and partly because TOUR20 makes it easier to work with small sections than with the whole outline.

- *Creating the Final Product.* With either method, your final steps will be adding any necessary text with INTRODUCE and SUMMARIZE, and then creating a paper printout (which is formatted with indentations) or a disk file (which has no indentations, unfortunately) to use for reference. All the output is done through a separate program, ROFFTOUR—not the easiest program to make friends with and not up to the quality of TOUR20 itself.

- *Finding TOUR20's Weak Spots.* TOUR20 has three glaring problems in its generally solid user interface:

1) You can enter a very long head-

ing—TOUR20 will simply wrap the line when you hit the edge of the screen—but after 134 characters, TOUR20 will start your text in the next heading, without any warning. You don't find out what's happened until you hit <RETURN>.

2) If you accidentally hit ^C during a session, you drop straight out of TOUR20 into CP/M, without any chance to save your work.

3) If you hit ^Z accidentally, TOUR20 goes into an infinite loop (at least on my machine).

You're warned against these last two in the documentation, but that's no protection against accidents—and no substitute for good error-trapping. All three problems need to be fixed.

- *Is TOUR20 worth having?* Yes—if you're willing to make yourself responsible for avoiding the three traps mentioned above. I think TOUR20 is an interesting new program and easy to use, now that I've got a feel for how it works and understand its limits. It lets me do things I can't do with a word

processor, and because it works entirely in memory, it's quite fast.

At first, TOUR20 and I circled each other like two stray cats, but now it's settled in to a regular space on my working disks.

TOUR20 was originally released as "shareware" (free distribution, \$30 suggested contribution), but Ed Taychert has now generously released it completely into the public domain and plans to remove the shareware notice for TOUR21 as well.

- *Where to Get VDO25 and TOUR20.* Both VDO25 and TOUR20 are probably still too new to be in most public domain software libraries. If you have a modem, you can find these programs on most CP/M bulletin boards. If you don't have a modem, find someone in your local users' group who does, and ask him or her to get the programs for you.

One final comment: both VDO25 and TOUR20 are fine examples of what the public domain is capable of producing. □

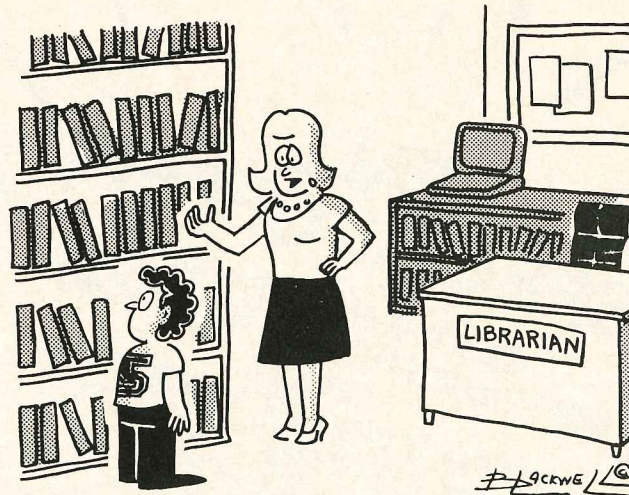

"NO, BILLY, WE DON'T REFER TO THESE AS 'HARD COPIES'! THEY'RE CALLED BOOKS!"

10 Powerful Reasons for Kaypro® Owners to Stop Using Their Old Perfect Software™

FALL SPECIAL OFFER!
 GET THE NEW PERFECT SOFTWARE FOR JUST \$49.95 EACH.
 OR BUY PERFECT WRITER™, FILER™, CALC™ FOR JUST \$99.95 AND GET PERFECT LINK™ FOR \$9.95!
 See details in ad. Offer expires October 15.

The Perfect™ Software that came bundled with your Kaypro® was good. But now, there's a whole new Perfect Software 2.0 series—Perfect Writer™, Perfect Calc™ and Perfect Filer™ programs—that's even better.

1 New Perfect Software 2.0 is easier to use.

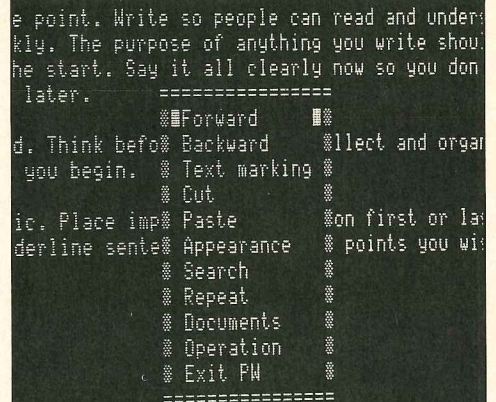

Perfect Software 2.0 features pop-up menus that use simple English language words. You can handle every function with the touch of a single key-stroke, so you never have to memorize complicated commands again. And because Perfect programs share common commands, you only have to learn one to know how to use them all.

2 New Perfect Software 2.0 is more convenient.

Now you can handle important document utilities, plus move from one Perfect program to another, without having to exit to CP/M.® That saves you time!

3 New Perfect Software 2.0 is backed by comprehensive customer support.

Answers to your technical questions are as close as your telephone. Just call our special customer service number and get instant help!



The New

4 The new Perfect Writer program comes with a spelling checker and thesaurus.



They're both included with the program! The Perfect Speller™ disk helps you prevent spelling mistakes. And the new Perfect Thesaurus™ disk helps you choose exactly the right word for what you're writing. So now it's easier to write better.

5 Format and print your document in one simple step.

Just select the print option, and automatically format your document at the same time. And Perfect Writer features support most popular printers, too.

6 The new Perfect Filer program lets you build larger databases. And store them on one disk.

```
Last name: Wilson_____ First: Robin_____ MI: B____
Address: 3427 West Oak Street_____
City: Costa Mesa_____ State: California_____ Zip: 92626_____
Home Phone: (714) 555-1234
Entry Date: 10/18/76          Soc. Sec. No.: 123-34-5789
1st Quarter Quota: $__1000.00_ Actual: $__1050.00
2nd Quarter Quota: $__2000.00_ Actual: $__1995.00
3rd Quarter Quota: $__2500.00_ Actual: $__2595.00
4th Quarter Quota: $__3000.00_ Actual: $__5000.00
```

Perfect Filer Version 2.00 (c) 1984 Perfect Software, Inc.
Press ESC for the menu

You can sort your Perfect Filer database according to nine different numerical and alphabetical categories.

Now you can put up to 128 different fields in each Perfect Filer record—

room for more information. And you can store up to 16 databases on one diskette.

7 The new Perfect Filer program is more versatile.

You can manage your information like never before. Sort records according to nine different criteria, alphabetical and numerical. Plus, you can automatically transfer data between files.

```

1 2SALES INTERNATIONAL
3 Yearly Sales
4
5
6
7 NAME          SOC SEC NO 1ST  2ND  3RD  4TH  1ST
8
9 Wilson, Robin 123-34-5789 1000 2000 2500 3000 1050
10 Jones, Mary  371-23-2345 1000 2000 2500 3000 950
11 Scott, Kevin  5=====0 2000 2500 3000 1400
12 Juarez, Sam  5#View      #00 3000 3500 4000 2100
13 Mills, Cathy  6# Text marking #0 3000 3500 4000 2200
14 Smith, Joy    4# Cut & Paste #0 3000 3500 4000 2100
15
16 # Appearance
17 # Repeat          TOTAL SALES 9800
18 # Datasheets
19 # Operations
20 # Exit
21 # =====
22
Memory available: 29920 (91%)

```

You can transfer data from your Perfect Filer database to a Perfect Calc spreadsheet and use it to develop projections, reports and analyses.

8 Use Perfect Filer data to build your new Perfect Calc spreadsheet.

Here's capability you never had until now. Use the Perfect Filer program to enter and sort alphabetical and numerical data. Then, you can transfer the data to a Perfect Calc spreadsheet, without any modification, and use it to develop sales reports, projections—virtually any kind of analysis.

9 Regional recalculation saves you time and keystrokes.

Spreadsheet operation has never been so simple. With regional recalculation, you can change some numbers, without changing them all. What's more, you can move blocks of data around your spreadsheet without having to rekey information.

10 New Perfect Software 2.0 is easier to get.

Now the best news of all. The new Perfect Software 2.0 family is available now at a special price just for Kaypro owners. Do it today—and start working faster, easier and better!

Perfect Software 2.0 series is compatible with all Kaypro II and Kaypro 4 models originally bundling Perfect Software.

SPECIAL OFFER! Please send me the Perfect Software 2.0 programs I've indicated for \$49.95 plus \$5 handling for each program.

- Perfect Writer (suggested list \$199.00)
- Perfect Filer (suggested list \$199.00)
- Perfect Calc (suggested list \$199.00)
- Perfect Link (suggested list \$129.00)

SAVE EVEN MORE! Get the Perfect Library with all three programs for just \$99.95, plus \$10 handling, and we'll also give you Perfect Link telecommunications software for \$9.95! A \$726.00 value for \$109.90.

California residents add 6% sales tax.

Enclosed is my check for the amount of \$_____ payable to THORN EMI Computer Software, Inc.

NAME _____

ADDRESS _____

CITY _____ STATE _____ ZIP _____

TELEPHONE _____

PLEASE PRINT CLEARLY

Mail to: THORN EMI Computer Software, Inc.
P.O. Box 16549, Irvine, CA 92714 PF-SP-85

For faster service, order direct using your credit card. Call (800) 225-8327. In California, call (800) 332-8327.

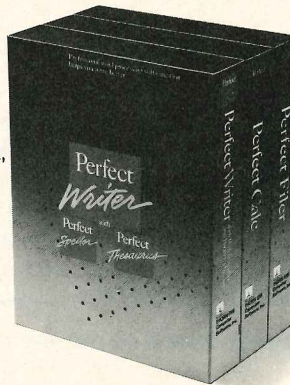

Perfect The Perfect Way to Work Better.



THORN EMI Computer Software, Inc.

Costa Mesa, CA 92626.

Kaypro is a registered trademark of Kaypro Corporation. CP/M is a registered trademark of Digital Research Corporation. Perfect Software, Perfect Writer, Perfect Filer, Perfect Calc, Perfect Speller, Perfect Thesaurus are trademarks of Perfect Software, Inc., used under license. © 1984, THORN EMI Computer Software, Inc. All rights reserved.

Perfect Software 2.0 for Kaypro.®

NOW! NON-COPY PROTECTED.

You type it in and save !!!

Kaypro owners . . . you can learn to activate our typesetting system within very little time. Books, manuals, newsletters, etc. can be produced at lower cost. By mail or by modem. Call or write for **FREE COMPLETE OPERATING INFORMATION.**

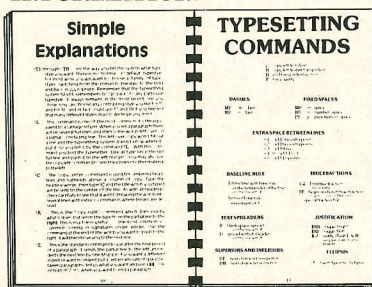

**ACCENT
GRAPHICS**

226 So. 16th St. • Lincoln, NE 68508
(402) 475-5533
Quality Service

EDU-CATE WITH EDU-KIDS !!!!

Here's a program for your child To make that spelling grade go wild. Customized lists from their book, Help provided, need they look. A list shows the words they miss, Spelling drills cease and desist. So if your child desires an "A", **SPELL-SO-WELL** shows the way.

Send check or money order to:

KP-1

Edu-Kids Software Co.
627-C Archdale Drive
Charlotte, NC 28210

Name: _____

Address: _____

City: _____

State: _____ Zip: _____

(\$29.95 plus \$2.00 shipping & handling)
(N. C. residents add 4.5% sales tax)

ALL KAYPROS EXCEPT ROBIE & KAYPRO 16

Trademarks: Kaypro (Kaypro Corp.), CP/M
(Digital Research, Inc.)

DU

(continued from page 64)

The Hex/ASCII Connection

Computers deal only with binary numbers, and the smallest piece of information a computer can work with is a single binary digit (0 or 1), which is called a "bit." Your Kaypro usually works with a group of eight bits, called a "byte," which might look something like this: 10011101. Depending on its context, a single byte can represent an instruction telling the computer what to do, a numeric value (like the number of lines on a page), or a character (like the letter "A").

Hexadecimal Numbers. It's very inconvenient for humans to work with bytes in a form like 10011101, so they are often translated into hexadecimal numbers, which are more compact. Technical programs like DU, for example, usually display bytes as hexadecimal numbers. These hexadecimal numbers work much like the familiar decimal ones except that where the decimal system has 10 single digits (0-9), the hexadecimal system has 16 single digits (0, 1 . . . 8, 9, A, B, C, D, E, F). In hexadecimal numbers, when you add 1 to hexadecimal F, you get 10 hexadecimal (which equals 16 decimal). To get a fuller explanation of hexadecimal numbers, read my article "Bits, Bytes, and Hexadecimal Numbers" on page 35 of the July/August 1985 **PROFILES**.

Hexadecimal numbers are usually written with a trailing **H** to distinguish them from decimal numbers, so that hexadecimal 1A is written 1AH or 1Ah. I use a lower-case **h** to show hexadecimal numbers, except when I'm reproducing what you'll see on your screen, as in the examples from the DU session. You *never* type the **h** when entering a hexadecimal number while you're using DU.

ASCII Characters. A byte can represent a character, like the letter "A," but the relationship is arbitrary—there has to be a system to

specify which byte represents which character. In the microcomputer world, the most commonly used system is ASCII (American Standard Code for Information Interchange). In the back of your *Kaypro User's Guide*, you'll find an ASCII chart, which lists each possible character together with its corresponding hexadecimal value: 41h equals A, 42h equals B, etc.

The ASCII characters are represented by bytes that use only seven of the possible eight bits—the eighth bit (called the high bit) is always set to 0. WordStar, however, uses this eighth bit for its own purposes. In a WordStar document file, some characters (the last letter in a word, for example) have this eighth bit set to 1, so they are no longer standard ASCII characters. That's why if you use CP/M's TYPE command to list a WordStar document file on the screen, you'll see odd graphics characters instead of letters in various places. Fortunately, DU removes these eighth bits from every byte in its ASCII display, so that when you display part of a WordStar file, you see only normal characters. □

How Disks Are Organized

Inside the square, flat package people call a floppy disk is a circular piece of flexible plastic with a gray-brown magnetic coating on both sides. This smooth, glossy surface is as featureless as it looks, until you format the disk. When you do format the disk, you make magnetic marks on that surface, dividing it into *tracks*, arranged like concentric rings, and *sectors*, which cut up the tracks like slices of a pie (see Figure 1). If you have double-sided drives (Kaypro 2X, 4, and 10), both sides of the disk will be formatted. If you have single-sided drives (Kaypro II and 2), only

(continued on page 83)

NO MORE PENCILS

(continued from page 32)

Where to Find Them

Advent Products, Inc.: 3154-F E. La Palma Ave., Anaheim, CA 92806 (800/821-8778; 800/521-7182)

Numbers & Math—\$19.95
Letters & Language—\$19.95
BASIC Tutorial—\$19.95

American Training International: 12638 Beatrice St., Los Angeles, CA 90066 (213/823-1129; 800/421-4827)

Skill Builder Series—\$39.95 each
Training Power Series—\$75 each

Answer in Computers, The: (619/287-0795)

Toricelli Series

Dynacomp, Inc.: 1064 Gravel Rd., Webster, NY 14580 (716/671-6167; 800/-828-6772)

Master Drill—\$18.95
Teacher's Aide—\$17.95
Teacher's Gradebook—\$49.95
Spell Master—\$39.95
Crypto—\$17.95
Management Simulator—\$29.95
Trivia Mania—\$39.95

Public Interest Software, Center for Science in the Public Interest: 1755 S St. NW, Washington, DC 20009 (202/-332-9110)

Nutribytes—\$39.95
Eco-Paradise—\$39.95

Resource Software International: 330 New Brunswick Avenue, Fords, New Jersey 08863 (201/738-8500)

Modules for Grades K-College—

\$34.95 each
Automatic Test Author—\$89.95

Software Academy: 2222 Morley Street, San Diego, CA 92111 (619/-571-8411)

Professor 3T Series—\$69
Artificial Intelligence Version—\$199

Tellon Software: P.O. Box 1464, La Mirada, CA 90637 (714/994-5135)

Language Tutor—\$29.95
Memory—\$29.95

DU

(continued from page 82)

one side will be formatted.

Each sector on your disk is a pigeonhole in which your Kaypro can store information, and it can be located through its address—the combination of its track number (from 0-79 for double-sided drives or 0-39 for single-sided) and its sector number (from 1-40) within a given track. The outermost track (track 0) on a Kaypro disk is used to store most of the CP/M operating system and is often called the system track. The next track (track 1) is used to store the directory of files on the disk and the rest of the CP/M operating system. Tracks 2 and beyond are used to store your files and are usually called the data or storage tracks.

Re-ink any fabric ribbon
AUTOMATICALLY for less
than

5¢ Mac Inker

Extremely simple operation, with built in electric motor. We support over 750 types of printers - cartridge, spool, harmonica, or zip pack type. Most MAC INKER(s) cost less than \$60.00. (Add \$3.00 for UPS shipping anywhere in the US).

Use your MAC INKER to re-ink your dry cartridges (for less than 5 cents in ink) and watch the improvement in print-out quality. Our residue-less, lubricated, dot-matrix ink yields a darker print than most new ribbons. Or get any of our 6 basic ink colors: brown, blue, red, green, yellow, purple and use MAC INKER to **CREATE YOUR OWN COLORED CARTRIDGES**. We have uninked cartridges. Load the cartridge on MAC INKER, ink in the desired color, and re-ink when appropriate.

Most cartridges can be used almost indefinitely, if ribbon is regularly re-inked, kept moist and lubricated so that the fabric does not fray. Some customers have reported 80 re-inkings of the same cartridge.

As of February 85, we have over 30,000 MAC INKER(s) in the field, in 5 continents (220V motors available). MAC INKER has been reviewed, approved and flattered in most magazines and even in the **NEW YORK TIMES** and the **CHICAGO SUN TIMES**.

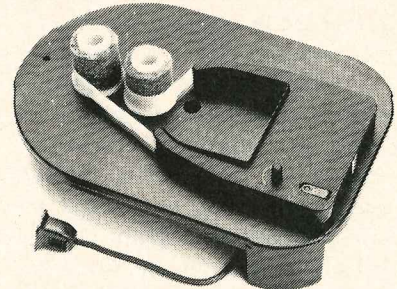

Order toll free 1-800-547-3303

or ask for free, detailed brochure. Dealers inquiries welcome.

Computer Friends

6415 SW Canyon Court
Suite #10
Portland, Oregon 97221
(503) 297-2321 (24 hour line)

NEW

Update your OKIDATA
and other open spool printers
with our patented self-inking ribbons.

Controlled Printout Devices will outlast ordinary spooled ribbons at least 15 to 1.

Please write or phone for complete information.

Name _____

Address _____

City _____ State _____ Zip _____

CONTROLLED PRINTOUT DEVICES, INC.

P.O. Box 869, Baldwin Road
Arden, North Carolina 28704
(704) 684-9044

Technical Forum

by Tom Enright

More Juki features

Several letters have come in detailing problems some of our users have been having with the special characters on Juki printwheels. Quite a few of you have had trouble with the WordStar User Patches (^PQ, ^PW, ^PE, and ^PR) causing your left margin to be offset one character to the right after each use.

This situation comes about from Juki's Diablo 630 compatibility. WordStar makes certain assumptions about a Diablo 630 printer. What it assumes is that User Patches 1 through 4 will only be used for accent characters. An accent character is one that is printed above another character to indicate special pronunciation.

The result is that when WordStar sends one of these commands to a Diablo 630, it sends a backspace and then the code for the special character. Both WordStar and the printer are aware of what has happened and take the situation into account in their margin calculations. The Juki does the same thing.

A problem comes about when something other than an accent character is defined as one of the user patches (User 1 through User 4). If you try to use the print-code to print a stand-alone special character, the special character is printed on top of the preceding character. If you try to get tricky and put a space in front of the special character, either WordStar or the printer gets confused about where the left margin is supposed to be.

You get similar results on the Juki and on a Diablo 630. It isn't exactly the same result—the margin error is in the opposite direction on a Diablo—but it still loses track of the left margin.

You can get around this problem in a couple of ways. The first way would be to go through the complete "Specialty Printer" installation process from scratch, defining every feature of your printer as WINSTALL asks for it.

The other method would be to leave your printer selection as Diablo 630 and reserve the "User Patches" for accent marks. Other special characters use a normal character space that could be assigned to Phantom Space or Phantom Rubout.

The last alternative would be to assign command sequences for stand-alone characters to a special keystroke with a key redefinition program. Escape sequences for special characters are short enough to assign to a key on your numeric pad with CONFIG.

More WordStar

Our last issue's Technical Forum included a WordStar patch to eliminate the annoying WordStar graphic screen. Well, one of our readers has taken that idea one step further. Mark Frank of Birmingham, Alabama has come up with a patch to skip both the graphics screen and the version sign-on screen.

This patch jumps past the first two screens that you would normally see when invoking WordStar and puts you directly at the Opening Menu. As with the patch from last month, this one is for CP/M WordStar 3.3 only. At the same location where I had you insert three NOP instructions, Frank has put a **C3 27 3D**, which means to jump to address 3D27.

Our standard instructions for patching apply to this procedure. Never patch your working or master diskette. Always patch a copy of

your working diskette and test the new version thoroughly before transferring it to your working diskette. In the following procedure, your entries are in boldface type. Assuming that you have both DDT and WordStar on the diskette in drive A, the steps for installing this patch are:

```
A0> DDT WS.COM
```

```
DDT VERS 2.2
```

```
NEXT PC
```

```
4600 0100
```

```
-S3CF4
```

```
3CF4 CD C3
```

```
3CF5 2A 27
```

```
3CF6 1B 3D
```

```
3CF7 CD . (Yes, a period)
```

```
GO (G zero, not GO.)
```

```
Warm Boot
```

```
A0> SAVE 69 WS.COM
```

I can foresee only one instance in which this patch might become inadvisable. If you work with more than one version of WordStar on a disk, you could accidentally use the wrong version after installing this patch. On my WordStar working disk are three different versions of WordStar 3.3: one for a parallel dot-matrix printer, one for a serial daisywheel printer, and one for testing new patches.

While each version has a different name, each one also has a different message on the sign-on screen. Since I can patch the terminal message for whatever I want it to say, my patch-testing version signs on with "Experimental Patches" as the assigned terminal. The other two versions, for different printers, sign on with the printer name and model number. I've come to depend on that information to tell me that I didn't inadvertently invoke the wrong WordStar file.

If you regularly use more than one customized version of Word-

Star, you may want to think twice before doing this patch. But, if you use only one version of WordStar, this patch can save you some time.

Warped video

I've had several letters from users who complain that lines of text on their screens are tilted. That is, the lines are higher at one end than the other end. There is a cure for this (other than learning to type with your head tilted to the side).

On the neck of the CRT is a white plastic collar with coils of fine wire in it. This collar controls how lines are squared on the screen. The only thing keeping this collar in adjustment is one clamp. It's a simple procedure to loosen the clamp and rotate the collar until the display is square.

The only problem is that this adjustment is easiest to make when the computer is on and a test pattern of lines is on the screen. This means putting your hand inside the computer right next to some rather high voltage while making the adjustment. The screw holding the clamp in place is also invariably facing the wrong direction to reach easily with a screwdriver. *Unless you are experienced at this type of work, leave this adjustment to a technician.*

If you absolutely insist on performing this adjustment yourself, buy Kaypro's *Dealer Reference Manual*. The adjustment sequence is detailed in the section on CRT adjustments. And remember to remove any rings or watches before trying this—that is, unless you like having a ring melted while it's still on your finger.

Juki ribbon finale

We've also been getting piles of letters from Juki owners who have come up with their own solutions to ribbon problems. Many of the solutions entail bending thin sheet metal parts in one direction or another. I realize how much satisfaction a person gets by solving this kind of a problem, but we cannot publish fixes that require bending parts. So far the fixes that we've received involve bending one of four different parts, too many to select from by mail.

The other side of the coin on all these ribbon fixes is—why should they be necessary? Modifying a piece of equipment to suit your own requirements is one thing, but having to modify it so it will work in the first place is unacceptable. When you consider the price tag on these things, shouldn't they work right from the start?

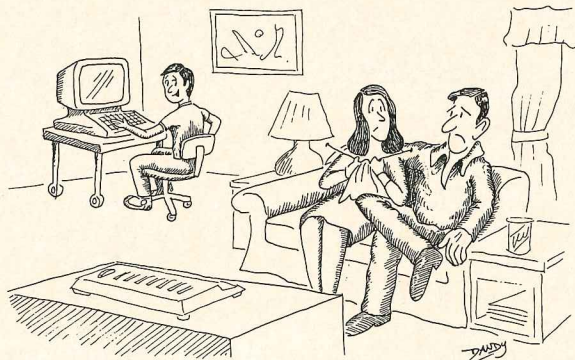

"I've finished my homework for the next seven years."

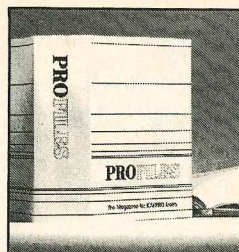

Special Offer

PROFILES® Binders

As a subscriber, you are entitled to purchase this top quality grey and blue vinyl covered binder that holds 12 issues of your magazine and gives complete protection at a special price of only \$12.95. The binder opens flat for quick, easy reference and metal rods hold publication in place without punching holes.

Name _____

Address _____

City _____ State _____ Zip _____

Check Visa MasterCard COD

Card No. _____ Exp. Date _____

Gty. _____ Cost _____ Total _____

Profiles Binders \$12.95

Postage & Handling \$2.00

Total \$ _____

HORNBY INC.

**13901 Harbour Place
Prospect, KY 40059
502-228-1353**

BIZPROF™

CAPITAL INVESTMENT & NEW VENTURE ANALYSIS

FINANCIAL MODELING PROGRAM FOR BUSINESSES, BANKERS, CONSULTANTS, FINANCIAL ANALYSTS, VENTURE CAPITALISTS

Do you have a new product, new machine or new factory?

Based on input variables, you can calculate:

- 10 Yr. Income Statements, Balance Sheets
- Allows For Bank Loans, Interest, Repay't
- Depreciation, ACRS
- Cash Flow, Discounted Cash Flow, Net Present Value, Discounted Payback Period, Internal Rate Of Return
- Break-even Analysis
- Twenty-Two Ratios

Specify KAYPRO® 2, 4 or 10

(Illinois Residents Add 6% Sales Tax)

Send Check For \$289.00, or Write To:

BIZPROF SOFTWARE, INC.
6 WHITBY COURT
LINCOLNSHIRE, ILLINOIS 60015

SMART-PIK NFL & USFL Football Handicapping Program

PURPOSE: Do-it-yourself Program. For Kaypro users interested in predicting the outcome of professional football games.

HOW IT WORKS: Each week, enter the stats required by the SMART-PIK formula. SMART-PIK projects the number of points that each team is likely to score (and allow) against its next opponent.

RESULTS: A winning record, against the pointspread, in each of the last 4 Pro Football seasons. (1983 and 1984, NFL and USFL. More than 500 selections.)

QUICK & EASY: Required stats are obtainable from any newspaper. I/O takes about 2 hours per week. (Also, data maintenance via mail or modem is an available option.)

VARIABILITY FEATURES: You can easily vary the SMART-PIK selection determinants. Further experimentation may produce still better results.

Developed by Marty Mendelsohn and Jim Thompson of Las Vegas Kaypro Users Group.

\$49.00 includes postage and handling. Specify what kind of Kaypro you have. MS DOS okay, too.

Phone or Write for Free Brochure



Marty Mendelsohn Associates

3807 Central Park Dr. #4 • Las Vegas, NV 89109
Tel. (702) 737-6256

VU*MOR BOOK RACK FOR YOUR KAYPRO®



VU*MOR 19.95
CLIP*MOR 4.95
SHIPPING 3.00

BEE*MOR ENTERPRISES

911 Western Ave. #406
Seattle, WA 98104
206-467-0630

Terms: M/C, VISA, COD, Check. Tax 7.8% for WA Residents. Kaypro is a registered Trademark of Kaypro Corp.



New Products

by Susan Hyman

The following new product listings are not reviews and should not be considered endorsements of tested products.

To be considered for publication in New Products, all press releases and product information should be sent to: New Products Editor, c/o PROFILES Magazine, Kaypro Corporation, P.O. Box N, Del Mar, CA 92014. Releases must state specific Kaypro compatibility and the products' prices. Send black-and-white photos if available.

Personal computer notebook/organizer

This customized three-ring binder system, called The Computer Companion, holds all computer essentials in one place. More than 20 special forms, labels, tabs and pockets are included to help users keep track of help cues, commands, database search methods, and hardware and software documentation, among other information.

The Computer Companion can be used to transport disks, reference materials, and paperwork between home and office.

The 5 1/2" by 8 1/2" notebook is available in brown, black, wine, gray, silver or cranberry vinyl.

\$39.95. Alfred Publishing Company Inc., P.O. Box 5964, Sherman Oaks, CA 91413 (800) 292-6122 or in CA: (800) 821-6083.

Users' group catalog and software library

The New York Amateur Computer Club (NYACC) has published a public domain software catalog for PC-compatible machines like the Kaypro 16 and 286i.

The catalog, which covers the PC/Blue Library, contains articles on public domain software and users' groups, a diskette volume list, a program index to 19 topics, a

diskette table of contents, an alphabetical index of files, and descriptions of commonly used filename extensions.

New York Amateur Computer Club, P.O. Box 106, Church Street Station, New York, NY 10008.

Math game

Cosmic Math is a game that uses graphics to teach math. It is a space adventure game, using a spaceship traveling the galaxy and aliens behind you asking questions on math. There are versions for addition, subtraction, multiplication and division. Four different skill levels are available, including grades 1-3, 4-6, 7-9, and a fraction game for grades 5 and up. Users must have machines with graphics capabilities.

\$14.95. Kaypro 2, 4, and 10. Applied Software Products, P.O. Box 292, Glassboro, NJ 08028.

Aviation route planning software

Automated Route Consulting System™ is a route planning system for pilots that provides direct routes to destination airports.

The type of route given depends on the navigation system the pilot has available (i.e. VOR, RNAV, LORAN C, Omega and more). The pilot enters the departure and destination airports, specifies the type of flight plan desired—the computer does the rest.

All the "navaids" used for navigation are stored on the system disk, and the user also has the option of storing up to 400 airports. A list of all the navaids used, plus waypoint descriptions, is provided.

The package will perform route planning, update navaid and airport files, and list the navaid and airport files to the printer.

\$49. Kaypro 2, 4, 10 and 16. Miller Flight Planning Inc., 404

North Gardenia, Broken Arrow, OK
74012 (918) 258-8906.

Computer equity kit

This grassroots kit, entitled "Programming Equity into Computer Education," is designed to help ensure equal participation for girls, minority, disabled and low-income students in computer courses.

Published by PEER (Project on Equal Education Rights) and its newly formed National Center for Computer Equity, the kit is an answer to an earlier PEER report that documented a consistent pattern of inequity

Aimed at parents, educators and community leaders, the kit is an assortment of tools to help them work for equity in their local schools. It provides:

- sample interview questions for getting data on school policies, practices, and allocations regarding computers;
- interview questions which elicit data on the perceptions of teachers, students and administrators regarding access and other equity-related issues;
- sample forms and instructions for analysis of enrollment patterns by sex, by racial or ethnic groups, and for disabled students;
- an annotated listing of resources (articles, organizations and projects) on computer equity.

It was developed and published with the financial support of the American Express Foundation, Aetna Life and Casualty Foundation, the Edward W. Hazen Foundation, the Rockefeller Family Fund, the Carnegie Corporation, and the Ford Foundation.

Cost of this kit is \$9.95 prepaid and it can be ordered from PEER.

PEER, 1413 K St., NW, 9th Floor,
Washington DC, 20005 (202)
332-7337.

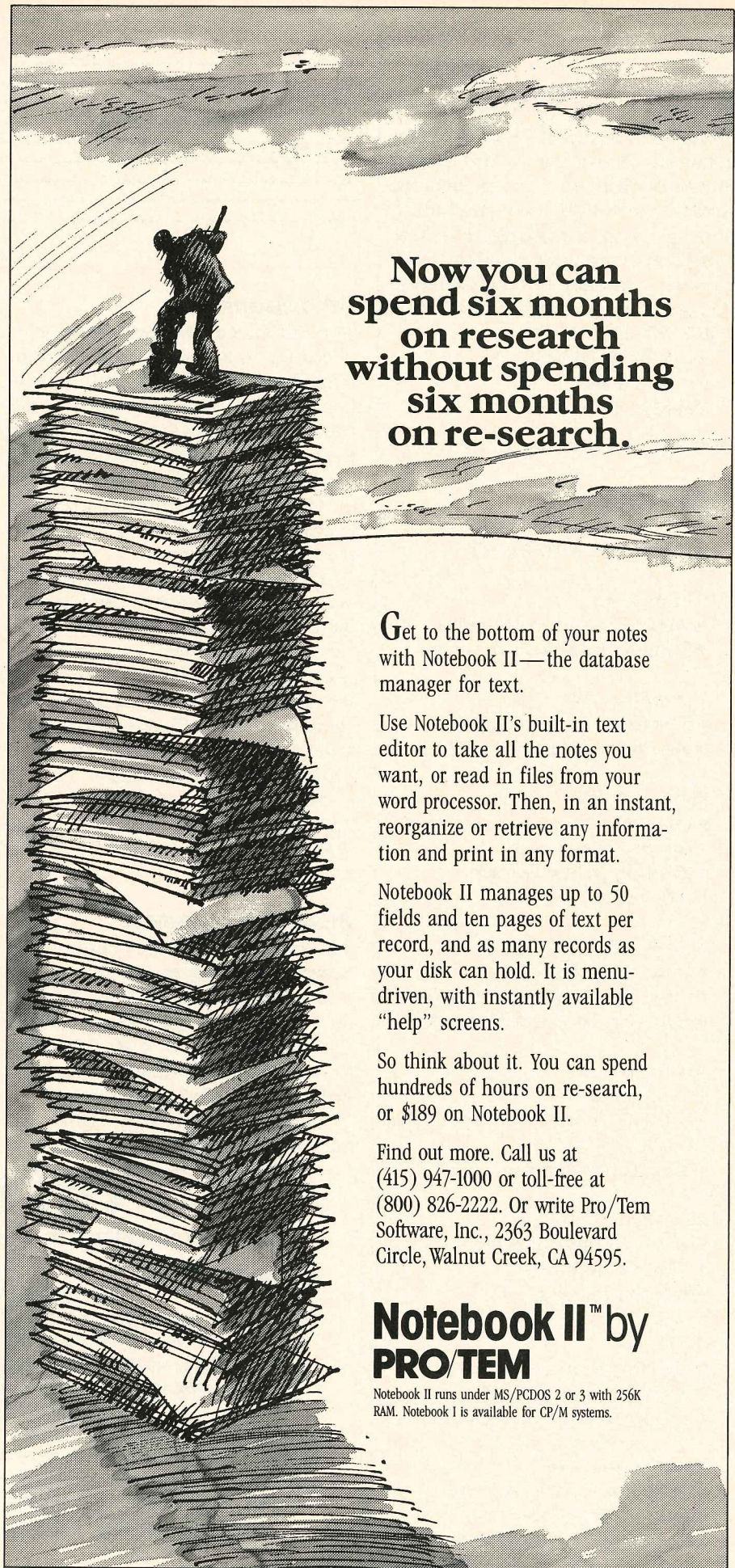

**Now you can
spend six months
on research
without spending
six months
on re-search.**

Get to the bottom of your notes with Notebook II—the database manager for text.

Use Notebook II's built-in text editor to take all the notes you want, or read in files from your word processor. Then, in an instant, reorganize or retrieve any information and print in any format.

Notebook II manages up to 50 fields and ten pages of text per record, and as many records as your disk can hold. It is menu-driven, with instantly available "help" screens.

So think about it. You can spend hundreds of hours on re-search, or \$189 on Notebook II.

Find out more. Call us at (415) 947-1000 or toll-free at (800) 826-2222. Or write Pro/Tem Software, Inc., 2363 Boulevard Circle, Walnut Creek, CA 94595.

**Notebook II™ by
PRO/TEM**

Notebook II runs under MS/PCDOS 2 or 3 with 256K RAM. Notebook I is available for CP/M systems.

Back Issues

Some back issues of *PROFILES* are available. If you live in the United States, we'll send you the desired issue(s) for \$4.00 each, including postage and handling. Enclose your name and address along with a check or money order payable to Kaypro Corporation and mail to:

PROFILES
 Attn: Back Issues
 P.O. Box 2889
 Del Mar, CA 92014

Highlights of past issues include:

September '84

- LOGO on the Kaypro
- Education with PILOT

October '84

- World of online databases
- Shopper's guide to modems

November '84

- First look at DataStar
- Freelance programming

February '85

- Use a modem—go to jail?
- Kaypro 16 preview
- Finding public domain software

March '85

- Unique applications
- Computerized speechwriting
- Statistical software roundup

April '85

- Famous users
- dBASE II and the real-time clock
- Tax prep software

May '85

- Alvin Toffler interview
- MBASIC marvels
- Telecommuting

June '85

- Micros in the Third World
- Perfect Series ver. 2.0 review
- Tracking the "desaparecidos"

July/August '85

- \$100,000/yr. freelancing
- Customizing WordStar
- Hardware review of 286i

New Products

Data spooler

The Advanced Data System spooler offers up to 256K of RAM for data transfer of scientific and business processing applications. The buffer/interface unit, which comes with 128K and may be upgraded, works well for EDP, spreadsheet and accounting printouts, telecommunications and local area network configurations.

The stand-alone spooler installs with two cable connections and is easily transferred from one hardware configuration to another. A digital readout displays memory in use or number of copies remaining to be processed. Two fingertip controls allow interrupt, resume and clearing of buffer memory.

\$600. Consolink Corporation, 1275 Sherman Dr., Longmont, CO 80501 (303) 651-2014 or (800) 525-6705.

300/1200 modem

The completely Hayes-compatible SmartTEAM modem has auto-dial and auto-answer features, as well as a built-in speaker with volume control. It comes with 20 commands, five responses, eight LED indicators, and dip switches.

The modem is Bell 103/212A compatible, supports touch-tone or

pulse dialing and is self-testing. It comes in an aluminum case with a two-year warranty.

\$349. Morrison & Dempsey Communications, 19209 Parthenia St., Suite D, Northridge, CA 91324 (818) 993-0195.

Tenant billing software

This package is tailor-made for marinas, airports, mobilehome parks, or any other business that has tenants paying rent and/or other constant charges. The Automatic Tenant Billing Program will bill recurring fees, plus add in optional miscellaneous charges such as utilities. The program is a form of accounts receivable combined with automatic billing.

The software will display current account status and show tenant information such as boat (or other) length, name and license/registration. A full range of transaction journals and reports, including an interactive vacancy list and delinquency report, come with the program

\$1,250. Kaypro 2, 4, 10, 16 and 286i. A demonstration disk is available for \$25. Office Computer Systems, 5627A Paradise Dr., Corte Madera, CA 94925 (415) 927-9844. □

OMNICOM

Specializing in Data Communications

PRODUCT DESCRIPTION	LIST	OMNICOM
DATASOLVERS MODEMS		
DS1200SMT: Internal for KayPro's, 300-1200 baud Hayes compatible smartmodem with software	\$349.95	\$299.95
DS300SMT: Internal for KayPro's 300 baud Hayes compatible smartmodem with software	\$199.95	\$169.95
SIGNALMAN MODEMS		
VOLKSMODEM 1200: 300-1200 baud, Hayes compatible smartmodem, auto-dial / auto-answer (needs cable)	\$299.95	\$219.95
MARK X: 300 baud, Hayes compatible smartmodem, auto-dial / auto-answer	\$169.95	\$115.95

CALL NOW TOLL FREE: 1-800-922-2329

1156 Amidon • Wichita, Kansas • 67203

Advertisers' Index

Advertiser	Page No.	Advertiser	Page No.
Accent Graphics.....	82	Micro Art Programmers.....	8
Advent Products.....	66,67	Micro Cornucopia.....	76,77
Alpine Data.....	12	Micro Solutions.....	7
Arizona Plastics.....	13	Microcomputer Systems Consultants	
AutoSoft.....	18		22
BizProf Software.....	85	Microsphere.....	1
Borland International.....	90	MicroTech, Inc.....	86
CDE Software.....	21	Multi-Tech Systems, Inside Front Cover	
C. Atkinson Programs.....	19	Mycroft Labs.....	Inside Back Cover
Central Computer Products..	23,24,25	Newstar Software.....	8
Chaucer Software.....	2	Ohio Plastics.....	37
Civil Computing.....	11	Omnicom.....	88
Computer Friends.....	83	PeopleTalk Associates.....	30,31
Computer Professionals, Inc.....	51	Pomerleau Computing Systems	89
Computerware.....	32	Practical Business Software.....	58
Controlled Printout Devices.....	83	Pro/Tem Software.....	87
Cuesta Systems.....	39	PROFILES Magazine.....	15
Custom Program House.....	13	Resource Software International.....	4
Edu-Kids Software.....	82	Rocky Mountain Software Systems	40
Financial Track Systems.....	73	SOS Computing.....	39
Flo Systems, Inc.....	57	Softcraft, Inc.....	9
Frank-Art.....	58	Spectre Technologies.....	65
H & E Computronics.....	Back Cover	Stanton Software.....	17
Hornby, Inc.....	85	Techware.....	18
Huntington Data Systems.....	56	Tellon Software.....	74
Hurd Computer Systems.....	11	Thorne EMI.....	80,81
Integrated Computer Systems.....	89	Wall Street Journal.....	38
James River Group.....	5	Walonick Associates.....	72
Kamasoft.....	19	WestWind Computer.....	75
Kaypro General Store.....	Insert	Woodsmith Software.....	12
MS & P Resources.....	89	Writing Consultants.....	37,72
Martin Mendelsohn Assoc.....	86	Xpert Software.....	73

This ad index is provided as an additional service. The publisher does not assume any liability for errors or omissions.

A COMPUTER IN YOUR BRIEFCASE?

Finally, a program that lets you take notes anywhere on a lap-size computer—and transfer those files directly to your Kaypro or PC-compatible home computer. **HardWire®** makes it simple, makes it fast.

HardWire® is menu-driven for simplicity. It moves data at speeds up to 19.2K baud! And it works with any combination of Kaypros, PC-compatibles and NEC, Radio Shack and Epson Geneva lap-size computers. All you need to add is a cable.

HardWire® program and easy-to-follow manual:

\$3995
only
Specify CP/M or MS-DOS. Or get both versions for just **\$59.95.**

VISA and MasterCard accepted.
To order or for information, call or write:

POMERLEAU COMPUTING SYSTEMS of Hyde Park
5634 S. Maryland Ave.
Chicago, IL 60637 (312) 667-2075

Call us for information on other lap-size computers.

SELLING

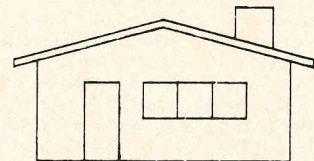

YOUR HOME?

(CURIOUS ABOUT POTENTIAL VALUE?)

YOU NEED APPRAISE

This program calculates estimated current value for real property, based on a variety of user specified inputs. Allows user created data files for multiple property tracking. Designed especially for KAYPRO owners, but runs on other CP/M-80 compatibles. Runs as .COM file; nothing else to buy. No printer required. Complete documentation on disk. Formatted for KAYPRO II (SSDD) unless otherwise specified.

Only \$14.95 postpaid (in USA only)
(NC residents add \$.70 sales tax)
Check or MO only - sorry, no COD's or credit sales.

MS & P RESOURCES
PO Box 16032
WINSTON-SALEM, N.C.
27115

NOW AVAILABLE IN 10 PACKS

Hub Reinforcing Rings
Tyvek Sleeves
Labels
Write Protect Tabs
Meets or Exceeds ANSI Standards
Lifetime Replacement Guarantee
100% certified Error-Free

MEET PLAIN JANE

(quality media at wholesale prices)

Now you can buy Name Brand
Quality Diskettes at Wholesale Prices

ALL THAT PLAIN JANE LACKS IS FANCY PACKAGING
SSDD - \$1.49 DSDD - \$1.89

AVAILABLE IN BOXES OF 50 DISKETTES ONLY

QUANTITY PURCHASE? WRITE FOR QUOTE.

COD's: CASH or CASHIERS CHECK ONLY



ORDER TOLL FREE
1-800-851-2753
ILLINOIS (call collect)
309-833-1157

Integrated Computer Systems
129 North Randolph Street
Macomb, Illinois 61455

Borland Introduces the Laws of *TURBO DYNAMICS*[™]

Laws That Work Like Magic. Whether considering technological excellence, or innovation in areas such as pricing, not copy-protection, licensing agreements, site licenses, 60 day money-back guarantee —Borland is clearly recognized as the software industry leader. The following three laws of "*Turbo Dynamics*"[™] exemplify our pledge for excellence.

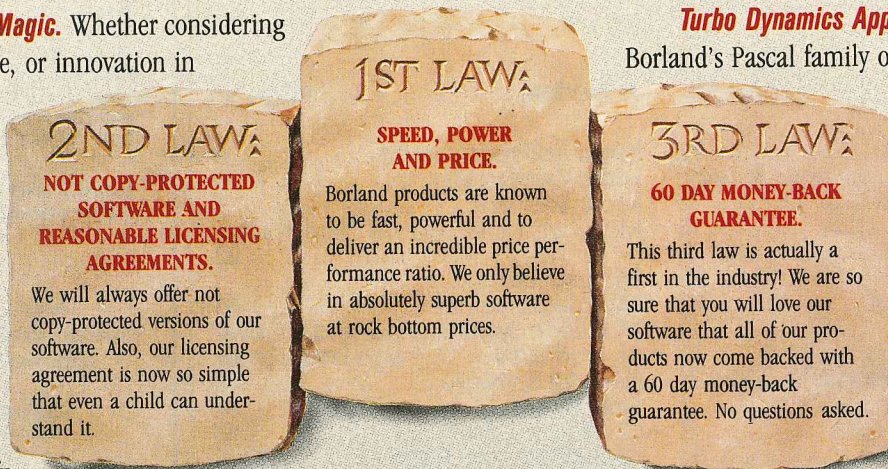

Turbo Dynamics Applies to Turbo Pascal. Borland's Pascal family of products is growing by leaps and bounds. You can now join hundreds of thousands of users and enter the world of Turbo Pascal programming. And remember, all three laws of *Turbo Dynamics* apply to all Borland products.

TURBO PASCAL[™] \$69.95



The industry standard. With more than 350,000 users worldwide Turbo Pascal is the industry's de facto standard. Turbo Pascal is praised by more engineers, hobbyists, students and professional programmers than any other development environment in the history of microcomputing. And yet, Turbo Pascal is simple and fun to use. **Free spreadsheet** included on every Turbo disk with ready-to-compile source code. **Options:** We offer the exciting Binary Coded Decimal (BCD) option for your business applications as well as an 8087 option for your number-crunching applications at a very low charge. Please refer to the coupon. **Portability.** Turbo Pascal is available today for most computers running PC-DOS, MS-DOS, CP/M-80 or CP/M-86. **Jeff Duntemann, PC Magazine:** "In its simplicity it achieves an elegance that no other language compiler has ever displayed."

TURBO GRAPHIX TOOLBOX[™] \$54.95



High resolution monochrome graphics and window management for the IBM PC. The Turbo Graphix Toolbox will give even a beginning programmer the expert's edge. It's a complete library of Pascal procedures and functions. Tools that will allow you to draw and hatch pie charts, bar charts, circles, rectangles and a full range of geometric shapes. Procedures that will save and restore graphic images to and from disk. And much, much, more. You may incorporate part or all of these tools in your programs and yet we won't charge you any royalties. Best of all, these functions and procedures come complete with commented source code on disk ready to compile.

TURBO TUTOR[™] \$34.95



From start to finish in 300 pages. Turbo Tutor is for everyone from novice to expert. Even if you've never programmed before Turbo Tutor will get you started right away. **A must.** You'll find the source code for all the examples in the book on the accompanying disk ready to compile. Turbo Tutor might be the only reference on Pascal and programming you'll ever need.

TURBO DATABASE TOOLBOX[™] \$54.95



The Turbo Database Toolbox is the perfect complement to Turbo Pascal. It contains a complete library of Pascal procedures that allows you to sort and search your data and build powerful applications. It's another Borland set of tools that will give the beginning programmer the expert's edge. **Get started right away: free database!** Included on every Toolbox disk is the source code to a working data base which demonstrates how powerful and easy to use our search system, Turbo-Access, really is. Modify it to suit your individual needs or just compile it and run. **Remember, no royalties!**



4585 Scotts Valley Drive, Scotts Valley CA 95066
Phone (408) 438-8400 Telex 172373

Copyright 1985 Borland International BI-1011

Turbo Pascal, Turbo Database Toolbox, Turbo Graphix Toolbox, Turbo Tutor and Turbo Dynamics are trademarks of Borland International, Inc.

TURBO PASCAL FAMILY

NOT COPY-PROTECTED

Available at better dealers nationwide. Call (800) 556-2283 for the dealer nearest you. To order by Credit Card call (800) 255-8008, CA (800) 742-1133

<p>Carefully Describe your Computer System!</p> <p>Mine is: <input type="checkbox"/> 8 bit <input type="checkbox"/> 16 bit</p> <p>I Use: <input type="checkbox"/> PC-DOS <input type="checkbox"/> MS-DOS</p> <p style="margin-left: 20px;"><input type="checkbox"/> CP/M 80 <input type="checkbox"/> CP/M 86</p> <p>My computers' name/model is: _____</p> <p>The disk size I use is:</p> <p><input type="checkbox"/> 3 1/2" <input type="checkbox"/> 5 1/4" <input type="checkbox"/> 8"</p> <p>Name: _____</p> <p>Shipping Address: _____</p> <p>City: _____</p> <p>State: _____ Zip: _____</p> <p>Telephone: _____</p>	<p style="text-align: center; font-weight: bold; color: white; background-color: red; border-radius: 50%; padding: 10px;">60 DAY MONEY-BACK GUARANTEE</p> <table style="width: 100%; border-collapse: collapse;"> <tr> <td>Pascal 3.0</td> <td style="text-align: right;">\$ 69.95</td> </tr> <tr> <td>Pascal w/8087</td> <td style="text-align: right;">\$109.90</td> </tr> <tr> <td>Pascal w/BCD</td> <td style="text-align: right;">\$109.90</td> </tr> <tr> <td>Pascal w/8087 & BCD</td> <td style="text-align: right;">\$124.95</td> </tr> <tr> <td>Turbo Database Toolbox</td> <td style="text-align: right;">\$ 54.95</td> </tr> <tr> <td>Turbo Graphix</td> <td style="text-align: right;">\$ 54.95</td> </tr> <tr> <td>Turbo Tutor</td> <td style="text-align: right;">\$ 34.95</td> </tr> </table> <p><small>*These prices include shipping to all U.S. cities. All foreign orders add \$10 per product ordered.</small></p> <p>Amount: (CA 6% tax) _____</p> <p>Payment: <input type="checkbox"/> VISA <input type="checkbox"/> MC <input type="checkbox"/> BankDraft <input type="checkbox"/> Check</p> <p>Credit Card Expir. Date: _____/_____/_____</p> <p>Card #: _____</p>	Pascal 3.0	\$ 69.95	Pascal w/8087	\$109.90	Pascal w/BCD	\$109.90	Pascal w/8087 & BCD	\$124.95	Turbo Database Toolbox	\$ 54.95	Turbo Graphix	\$ 54.95	Turbo Tutor	\$ 34.95
Pascal 3.0	\$ 69.95														
Pascal w/8087	\$109.90														
Pascal w/BCD	\$109.90														
Pascal w/8087 & BCD	\$124.95														
Turbo Database Toolbox	\$ 54.95														
Turbo Graphix	\$ 54.95														
Turbo Tutor	\$ 34.95														

COD's and Purchase Orders WILL NOT be accepted by Borland, California residents: add 6% sales tax. Outside USA: add \$10 and make payment by bank draft, payable in US dollars drawn on a US bank.

F28

Mycroft Labs Announces
a follow up to their enormously popular Suprterm to MITE Upgrade

A Super Deal on an MFDISK Replacement

The \$95.00 **COMPAT** Direct Disk Interchange Software System for \$29.95.* Exclusively for KAYPRO owners.

For a limited time, Mycroft Labs will be offering MFDISK owners a copy of **COMPAT** at a substantially reduced price. Each MFDISK owner will be allowed to purchase one copy of **COMPAT** at the reduced price of \$29.95 + \$2.55 postage and handling. With **COMPAT** you can Read, Write and Format over 60 different CP/M and MSDOS Disks (30 on single sided systems) on your Kaypro Computer. **COMPAT** allows you to change the personality of either or both drives and interchange foreign format CP/M disks with native ones. In addition, **COMPAT** allows you to initialize blank disks to any supported CP/M or MSDOS format. And when you purchase **COMPAT** we'll supply a utility to perform directories of, and transfer files to or from MSDOS disks, and a powerful replacement for PIP, called MYCOPY. **COMPAT** is also available for Sanyo 1000, 1150, 1250, Zenith-100, and other popular CP/M based computers.

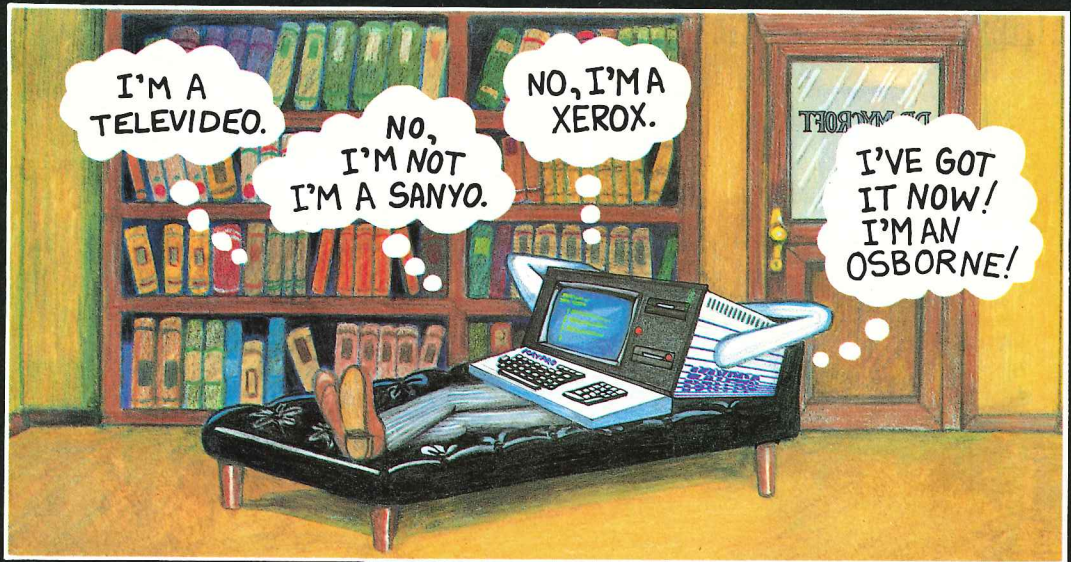

Give Your Computer Multiple Personalities

*This offer is also valid for owners of MicroSolutions **UniForm** software package on Kaypro Computers.

Mycroft Labs, Inc., P.O. Box 6045, Tallahassee, FL 32314

Yes, I would like to upgrade my copy of MFDISK to **COMPAT**

Enclosed is \$32.50 (which includes shipping, or \$34.00 for COD orders). Florida residents add applicable state Sales Tax.

Name: _____

Company: _____

Street Address: _____

City: _____ State: _____ Zip: _____

Phone: (_____) _____

Signature: _____

Available for Kaypro Models: 2/83, 2/84, 4/83, 4/84, 2x and 10.

PRO SEP. 1

**MYCROFT
LABS INC**

Phone: (904) 385-1141

Payment Method

Check COD

VISA MasterCard

Card # _____

Exp. Date: _____

Offer Expires September 30, 1985

Introducing the Most Powerful Business Software Ever!

FOR YOUR TRS-80 • IBM • APPLE • KAYPRO • COMMODORE 64 • MSDOS OR CP/M COMPUTER*

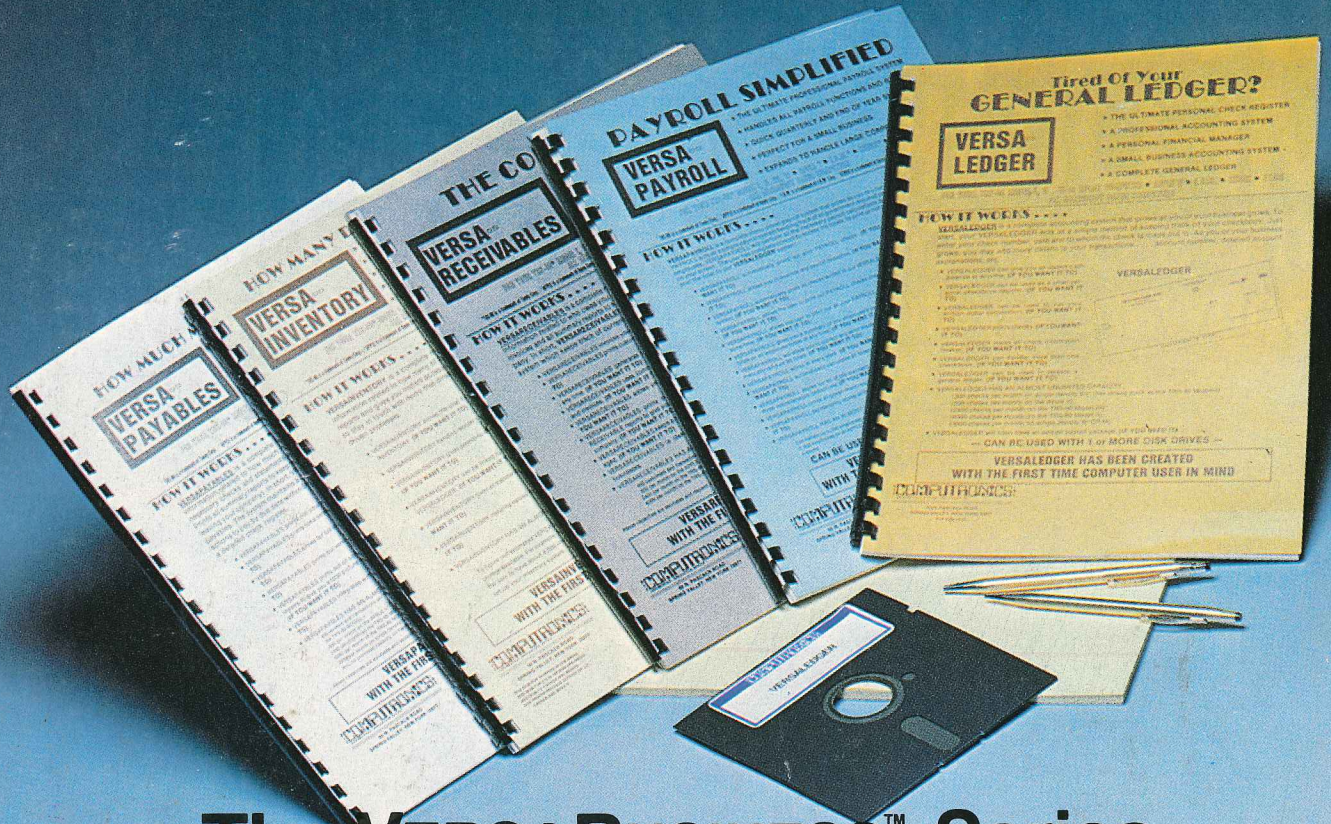

The VERSABUSINESS™ Series

Each VERSABUSINESS module can be purchased and used independently, or can be linked in any combination to form a complete, coordinated business system.

VERSA RECEIVABLES™ \$99.95
VERSA RECEIVABLES™ is a complete menu-driven accounts receivable, invoicing, and monthly statement-generating system. It keeps track of all information related to who owes you or your company money, and can provide automatic billing for past due accounts. VERSA RECEIVABLES™ prints all necessary statements, invoices, and summary reports and can be linked with VERSA LEDGER II™ and VERSA INVENTORY™.

VERSA PAYABLES™ \$99.95
VERSA PAYABLES™ is designed to keep track of current and aged payables, keeping you in touch with all information regarding how much money your company owes, and to whom. VERSA PAYABLES™ maintains a complete record on each vendor, prints checks, check registers, vouchers, transaction reports, aged payables reports, vendor reports, and more. With VERSA PAYABLES™, you can even let your computer automatically select which vouchers are to be paid.

VERSA PAYROLL™ \$99.95
VERSA PAYROLL™ is a powerful and sophisticated, but easy to use payroll system that keeps track of all government-required payroll information. Complete employee records are maintained, and all necessary payroll calculations are performed automatically, with totals displayed on screen for operator approval. A payroll can be run totally, automatically, or the operator can intervene to prevent a check from being printed, or to alter information on it. If desired, totals may be posted to the VERSA LEDGER II™ system.

VERSA INVENTORY™ \$99.95
VERSA INVENTORY™ is a complete inventory control system that gives you instant access to data on any item. VERSA INVENTORY™ keeps track of all information related to what items are in stock, out of stock, on backorder, etc., stores sales and pricing data, alerts you when an item falls below a preset reorder point, and allows you to enter and print invoices directly or to link with the VERSA RECEIVABLES™ system. VERSA INVENTORY™ prints all needed inventory listings, reports of items below reorder point, inventory value reports, period and year-to-date sales reports, price lists, inventory checklists, etc.

VERSA LEDGER II™ \$149.95
VERSA LEDGER II™ is a complete accounting system that grows as your business grows. VERSA LEDGER II™ can be used as a simple personal checkbook register, expanded to a small business bookkeeping system or developed into a large corporate general ledger system **without any additional software.**

- VERSA LEDGER II™ gives you almost unlimited storage capacity (300 to 10,000 entries per month, depending on the system),
- stores all check and general ledger information forever,
- prints tractor-feed checks,
- handles multiple checkbooks and general ledgers,
- prints 17 customized accounting reports including check registers, balance sheets, income statements, transaction reports, account listings, etc.

VERSA LEDGER II™ comes with a professionally-written 160 page manual designed for first-time users. The VERSA LEDGER II™ manual will help you become quickly familiar with VERSA LEDGER II™, using complete sample data files supplied on diskette and more than 50 pages of sample printouts.

SATISFACTION GUARANTEED!

Every VERSABUSINESS™ module is guaranteed to outperform all other competitive systems, and at a fraction of their cost. If you are not satisfied with any VERSABUSINESS™ module, you may return it within 30 days for a refund. Manuals for any VERSABUSINESS™ module may be purchased for \$25 each, credited toward a later purchase of that module. All CP/M-based Computers must be equipped with Microsoft BASIC (MBASIC or BASIC-80)

To Order:
Write or call Toll-free (800) 431-2818
(N.Y.S. residents call 914-425-1535)

- * add \$3 for shipping in UPS areas
- * add \$4 for C.O.D. or non-UPS areas

- * add \$5 to CANADA or MEXICO
- * add proper postage elsewhere



DEALER INQUIRIES WELCOME

All prices and specifications subject to change / Delivery subject to availability.

COMPUTRONICS

50 N. PASCACK ROAD, SPRING VALLEY, N.Y. 10977