

TANDY[®]

**Technical
Information Series**

**Notes
and
Jumpers**

01-0220 Computer Technical Services

```

*****
*
*
*   N O T E S   A N D   J U M P E R S
*
*
* Complete list of logic board jumpers for
* the Model II, 16, 12, 16B, 1000 series,
* 1200, 2000, 3000 series, 4000 series,
* 2500XL/XL2/SX, 4016SX, 4020SX, 5000MC,
* 6000 series computers, upgrade boards,
* all Hard Drives and Floppy Drives,
* Laptops, WP2, and WP100.
*
* PLUS the Model III, 4, 4D, and 4P
* computer main logic and related boards.
*****

```

COMPUTER TECHNICAL SERVICES
November 1991

CONTENTS

MODEL II (26-4001/2)	Model II.1
Notes	Model II.2
CPU Board Rev. A/B/C	Model II.2
CPU Board Rev. D	Model II.3
Keyboard/Video Board (early style)	Model II.3
Keyboard/Video Board (late style)	Model II.3
FDC Board (early style)	Model II.3
FDC Board (late style)	Model II.4
First 32K 280 Memory Board	Model II.4
Second 32K 280 Memory Board	Model II.4
64K 280 Memory Board	Model II.4
 MODEL III (26-1060/1/2/3/4/5/6)	Model III.1
4K Main Logic Board	Model III.2
16K/32K/48K Main Logic Board	Model III.2
Model III/4 Early FDC Board	Model III.2
 MODEL 4 (26-1067/8/9)	Model 4.1
16K Main Logic Board (standard)	Model 4.2
64K Main Logic Board (standard)	Model 4.2
128K Main Logic Board (standard)	Model 4.2
64K Main Logic board (gate array)	Model 4.3
128K Main logic board (gate array)	Model 4.3
 MODEL 4D (26-1070)	Model 4D.1
64K Main Logic Board	Model 4D.2
128K Main Logic Board	Model 4D.2
 MODEL 4P (26-1080)	Model 4P.1
Notes	Model 4P.2
Standard Main Logic Board	Model 4P.2
Gate Array Main Logic Board	Model 4P.2
 MODEL 12 (26-4004/5)	Model 12.1
Notes	Model 12.2
Main Logic Board	Model 12.2
Keyboard/Video Board	Model 12.3
Motorola Board	Model 12.3
 MODEL 16 (26-6001/2)	Model 16.1
Notes	Model 16.2
CPU Board Rev. D	Model 16.3
Keyboard/Video Board	Model 16.3
FDC Board	Model 16.3
280 Memory Board	Model 16.3
68000 6 MHz CPU Board	Model 16.4
68000 6 MHz CPU Board (reduced size)	Model 16.4
68000 Memory Boards	Model 16.4

TANDY COMPUTER PRODUCTS

CONTENTS (continued)

MODEL 16B (26-6004/5).....	Model 16B.1
Notes	Model 16B.2
Main Logic Board	Model 16B.3
Keyboard/Video Board	Model 16B.3
Video Driver Board	Model 16B.3
MODEL 6000 (a.k.a. TANDY 6000)(26-6021)	Model 6000.1
Notes	Model 6000.2
Main Logic Board	Model 6000.3
Keyboard/Video Board	Model 6000.3
8 MHz 68000 CPU Board	Model 6000.3
512K/1MEG 68000 RAM Board with 512K	Model 6000.3
512K/1MEG 68000 RAM Board with 1MEG	Model 6000.3
68000 8 MHz CPU Board (used with MMU upgrade) ..	Model 6000.4
68000 MMU Board	Model 6000.4
512K/1MEG 68000 RAM Board with 512K	Model 6000.4
512K/1MEG 68000 RAM Board with 1 MEG	Model 6000.4
TANDY 1000 (25-1000/A)	TANDY 1000.1
Main Logic Board	TANDY 1000.2
1000A Main Logic Board	TANDY 1000.2
TEAC FD-54B Floppy Drive Logic Board	TANDY 1000.2
10 MEG thinline (TM-252) Hard Drive logic board	TANDY 1000.2
Tandy 1000 WD1002S-WX2 Controller board	TANDY 1000.2
TANDY 1000EX (25-1050)	TANDY 1000EX.1
Main Logic Board	TANDY 1000EX.2
TEAC FD-55BV Floppy Drive Logic Board	TANDY 1000EX.2
TANDY 1000HX (25-1053)	TANDY 1000HX.1
Notes.....	TANDY 1000HX.2
Main Logic Board.....	TANDY 1000HX.2
Sony 3 1/2" Floppy Drive Logic Board.....	TANDY 1000HX.2
TANDY 1000RL/HD (25-1450/1)	TANDY 1000RL/HD.1
Introduction/notes	TANDY 1000RL/HD.2
Main Logic Board	TANDY 1000RL/HD.3
Audio Interface Board	TANDY 1000RL/HD.3
Power Supply	TANDY 1000RL/HD.3
Teac 235F 3 1/2" 720K Floppy Drive	TANDY 1000RL/HD.4
Seagate ST-325X 20 Meg Hard Drive	TANDY 1000RL/HD.4
Upgrade Options	TANDY 1000RL/HD.4

TANDY COMPUTER PRODUCTS

CONTENTS (continued)

TANDY 1000RLX/HD (25-1452/3).....	TANDY 1000RLX/HD.1
Introduction	TANDY 1000RLX/HD.2
Main Logic Board	TANDY 1000RLX/HD.2
Audio Interface Board	TANDY 1000RLX/HD.3
Teac 235HF-106U 3 1/2" 1.44M Floppy Drive	TANDY 1000RLX/HD.3
Seagate ST-351A/X 40 Meg IDE Hard Drive	TANDY 1000RLX/HD.3
Expansion Options	TANDY 1000RLX/HD.4
TANDY 1000SL (25-1401)	TANDY 1000SL.1
Notes	TANDY 1000SL.2
Main Logic Board	TANDY 1000SL.2
TANDY 1000SL/2 (25-1402)	TANDY 1000SL/2.1
Notes	TANDY 1000SL/2.2
Main Logic Board	TANDY 1000SL/2.2
TANDY 1000SX (25-1051)	TANDY 1000SX.1
Main Logic Board	TANDY 1000SX.2
TEAC FD-55BV Floppy Drive Logic Board	TANDY 1000SX.2
TANDY 1000TL (25-1601)	TANDY 1000TL.1
Notes	TANDY 1000TL.2
Main Logic Board	TANDY 1000TL.2
TANDY 1000TL/2 (25-1602)	TANDY 1000TL/2.1
Notes	TANDY 1000TL/2.2
Main Logic Board	TANDY 1000TL/2.2
TANDY 1000TL/3 (25-1603)	TANDY 1000TL/3.1
Introduction	TANDY 1000TL/3.2
Main Logic Board	TANDY 1000TL/3.3
Satellite Board	TANDY 1000TL/3.3
Sony MP-F11W-72D 720K Floppy Drive	TANDY 1000TL/3.3
Upgrade Options	TANDY 1000TL/3.3
TANDY 1000TX (25-1600)	TANDY 1000TX.1
Notes.....	TANDY 1000TX.2
Main Logic Board.....	TANDY 1000TX.2
Sony 3 1/2" 720K Floppy Drive Logic Board.....	TANDY 1000TX.2
Main Logic Board "Cleburn version"	TANDY 1000TX.3
Tandy 1100FD (25-3530)	TANDY 1100FD.1
Notes	TANDY 1100FD.2
Main Logic Board	TANDY 1100FD.2
Floppy Drive	TANDY 1100FD.3

TANDY COMPUTER PRODUCTS

CONTENTS (continued)

TANDY 1200 (25-3000/A)	TANDY 1200.1
Main Logic Board	TANDY 1200.2
1200A Main Logic Board	TANDY 1200.2
Floppy Drive Controller Board	TANDY 1200.3
Hard Drive Controller Board	TANDY 1200.3
Tandon TM100-2 Floppy Drive Logic Board	TANDY 1200.3
Tandon Internal 10 MEG Hard Drive Logic Board ..	TANDY 1200.4
Tandy 1200 WD1002S-WX2 Hard Drive Controller ...	TANDY 1200.4
Tandon TM65-2L Floppy Drive Logic Board	TANDY 1200.4
Tandy 1400FD/HD (25-3501/05)	TANDY 1400FD/HD.1
Notes	TANDY 1400FD/HD.2
Main Logic Board	TANDY 1400FD/HD.2
Teac FD235-136U	TANDY 1400FD/HD.3
20 MEG Hard Drive Kit	TANDY 1400FD/HD.3
Tandy 1400LT/HD (25-3500/A/B)	TANDY 1400LT.1
Notes	TANDY 1400LT.2
Main Logic Board	TANDY 1400LT.3
Citizen OPDB-12A 3 1/2" 720K Floppy Drive	TANDY 1400LT.3
Citizen OSDC-95A 3 1/2" 720K Floppy Drive	TANDY 1400LT.3
20 MEG CMS Lite Drive and Controller	TANDY 1400LT.3
1200 Baud Internal Modem for 1400LT	TANDY 1400LT.4
Tandy 1500HD (25-3506)	TANDY 1500HD.1
Introduction	TANDY 1500HD.2
Main Logic Board	TANDY 1500HD.2
Conner CP-2024 20 Meg IDE Hard Drive	TANDY 1500HD.2
Matsushita EME-263MG 3 1/2" 1.44M Floppy Drive .	TANDY 1500HD.3
1 Meg EMS SIMM Memory Module	TANDY 1500HD.3
2400 Baud Modem Board	TANDY 1500HD.3
TANDY 2000 (25-5103/4)	TANDY 2000.1
Main Logic Board	TANDY 2000.2
Mitsubishi M4853 Floppy Drive Logic Board	TANDY 2000.2
Mitsubishi M4853-1 Floppy Drive Logic Board	TANDY 2000.2
TANDY 2500SX (25-4076).....	TANDY 2500SX.1
Introduction	TANDY 2500SX.2
Main Logic Board	TANDY 2500SX.3
Floppy Drive	TANDY 2500SX.3
Upgrade Options	TANDY 2500SX.4
TANDY 2500XL (25-4074)	TANDY 2500XL.1
Notes	TANDY 2500XL.2
Main Logic Board	TANDY 2500XL.2
Floppy Drive	TANDY 2500XL.3
Hard Drives	TANDY 2500XL.4

TANDY COMPUTER PRODUCTS

CONTENTS (continued)

TANDY 2500XL/2 (25-4075)	TANDY 2500XL/2.1
Introduction	TANDY 2500XL/2.2
Main Logic Board	TANDY 2500XL/2.2
Floppy Drive	TANDY 2500XL/2.3
Upgrade Options	TANDY 2500XL/2.3
Service Notes	TANDY 2500XL/2.4
Tandy 2800HD (25-3550)	TANDY 2800HD.1
Notes	TANDY 2800HD.2
Main Logic Board	TANDY 2800HD.2
Math Coprocessor	TANDY 2800HD.3
1 MEG Memory Upgrade Board	TANDY 2800HD.3
Panasonic JU-257A213P 1.44M Floppy Drive	TANDY 2800HD.3
Conner CP-3024 20 MEG Hard Drive	TANDY 2800HD.3
Tandy 2810HD (25-3551/2)	TANDY 2810HD.1
Introduction	TANDY 2810HD.2
Memory Configurations	TANDY 2810HD.2
Power Supply	TANDY 2810HD.3
Video Display	TANDY 2810HD.3
Keyboard	TANDY 2810HD.3
Main Logic Board	TANDY 2810HD.3
Conner CP-2024 20 Meg IDE Hard Drive	TANDY 2810HD.3
Conner CP-2064 60 Meg IDE Hard Drive	TANDY 2810HD.4
Matsushita EME-263MG 3 1/2" 1.44M Floppy Drive .	TANDY 2810HD.4
1 Meg EMS SIMM Memory Module	TANDY 2810HD.4
2400 Baud Modem Board	TANDY 2810HD.4
TANDY 3000 (25-4000/1)	TANDY 3000.1
Notes	TANDY 3000.2
Main Logic Board (standard)	TANDY 3000.2
Main Logic Board (gate array)	TANDY 3000.3
Floppy Disk Controller Board	TANDY 3000.3
Floppy/Hard Drive WD1002-WA2 Controller Board ..	TANDY 3000.3
Floppy/Hard Drive WD1003-WA2 Controller Board ..	TANDY 3000.3
Mitsubishi M4854-3S Floppy Drive Logic Board ...	TANDY 3000.4
Mitsubishi MF504A Floppy Drive Logic Board	TANDY 3000.4
20 MEG Mitsubishi (MR522) Hard Drive Logic	TANDY 3000.4
20 MEG Seagate (ST225) Hard Drive Logic Board ..	TANDY 3000.4
40 MEG CDC (WREN II) Hard Drive Logic Board	TANDY 3000.5
Serial/Parallel Board Revision "A"	TANDY 3000.5
Serial/Parallel Board Revision "B" and "C"	TANDY 3000.5

TANDY COMPUTER PRODUCTS

CONTENTS (continued)

TANDY 3000 (12 MHZ) (25-4002)	TANDY 3000/12.1
Notes	TANDY 3000/12.2
Main Logic Board	TANDY 3000/12.2
Mitsubishi MF4854-347 Floppy Drive Logic Board ..	TANDY 3000/12.3
WD1002-WA2 Floppy/Hard Drive Controller	TANDY 3000/12.3
WD1003-WA2 Floppy/Hard Drive Controller	TANDY 3000/12.4
Enhanced Keyboard	TANDY 3000/12.4
TANDY 3000HL (25-4070/1)	TANDY 3000HL.1
Notes	TANDY 3000HL.2
Main Logic Board	TANDY 3000HL.2
Mitsubishi MF501A Floppy Drive Logic Board	TANDY 3000HL.2
Main Logic Board with Keylock.....	TANDY 3000HL.3
TANDY 3000NL (25-4072)	TANDY 3000NL.1
Main Logic Board	TANDY 3000NL.2
Tandy 3810HD (25-3571)	TANDY 3810HD.1
Introduction	TANDY 3810HD.2
Main Logic Board	TANDY 3810HD.2
Memory Configurations	TANDY 3810HD.2
Power Supply	TANDY 3810HD.3
Keyboard	TANDY 3810HD.3
Conner CP-2064 60 Meg IDE Hard Drive	TANDY 3810HD.3
Matsushita EME-263MG 3 1/2" 1.44M Floppy Drive..	TANDY 3810HD.4
2400 Baud Modem Board	TANDY 3810HD.4
TANDY 4000/A (25-5000/A).....	TANDY 4000/A.1
Notes	TANDY 4000/A.2
Main Logic Board Revision A	TANDY 4000/A.2
Main Logic Board Revision A-1, C	TANDY 4000/A.2
Sony 3 1/2" 1.44 MEG Floppy Drive Logic Board ..	TANDY 4000/A.2
Enhanced Keyboard.....	TANDY 4000/A.3
WD1002-WA2 Floppy/Hard Drive Controller.....	TANDY 4000/A.3
WD1003-WA2 Floppy/Hard Drive Controller.....	TANDY 4000/A.3
TANDY 4000LX (25-5100)	TANDY 4000LX.1
Main Logic Board Revision C, C-1	TANDY 4000LX.2
Sony MP-F73W-01D 3 1/2" 1.44 MEG Floppy Drive ..	TANDY 4000LX.2
WD1002-WA2 Floppy/Hard Drive Controller	TANDY 4000LX.3
WD1003-WA2 Floppy/Hard Drive Controller	TANDY 4000LX.3
TANDY 4000SX (25-4900)	TANDY 4000SX.1
Notes	TANDY 4000SX.2
Main Logic Board	TANDY 4000SX.2
Memory Board	TANDY 4000SX.5
Floppy Drive	TANDY 4000SX.5

TANDY COMPUTER PRODUCTS

CONTENTS (continued)

TANDY 4016DX/20LX/25LX/33LX (25-5001/5120/25/33) ...	4016DX/20/25/33LX.1
Notes	4016DX/20/25/33LX.2
CPU Logic Board	4016DX/20/25/33LX.3
Main Logic Board Revisions A-C	4016DX/20/25/33LX.3
Main Logic Board 4016DX Revision D	4016DX/20/25/33LX.4
Memory Board	4016DX/20/25/33LX.5
Parallel Port Configuration	4016DX/20/25/33LX.6
VGA Adapter Board (16 Bit)	4016DX/20/25/33LX.7
Super VGA Adapter Board (16 Bit)	4016DX/20/25/33LX.8
Floppy Drive	4016DX/20/25/33LX.8
Hard Drive	4016DX/20/25/33LX.9
TANDY 4016SX (25-4901)	TANDY 4016SX.1
Notes	TANDY 4016SX.2
Main Logic Board	TANDY 4016SX.2
Floppy Drive	TANDY 4016SX.3
Hard Drive	TANDY 4016SX.4
TANDY 4020SX (25-4903)	TANDY 4020SX.1
Introduction	TANDY 4020SX.2
Main Logic Board	TANDY 4020SX.2
Floppy Drive	TANDY 4020SX.4
TANDY 5000MC (25-6000)	TANDY 5000MC.1
Main Logic Board	TANDY 5000MC.2
CPU Board	TANDY 5000MC.2
0K Memory Expansion Adapter	TANDY 5000MC.3
TANDY 6000 - See Model 6000	TANDY 6000
TANDY WP2 (26-3930)	TANDY WP2.1
Notes	TANDY WP2.2
32K RAM Upgrade	TANDY WP2.2
32K Memory Card	TANDY WP2.2
Tandy WP-100 (26-3950)	TANDY WP-100.1
Notes	TANDY WP-100.2
Main Logic Board	TANDY WP-100.2
Quick Disk Drive	TANDY WP-100.2
3Server3 (26-5550)	3SERVER3.1
Power On Sequence	3SERVER3.2
Main Unit/Control Panel	3SERVER3.2
Thumbwheel Switch Settings	3SERVER3.2
Main Logic Connectors/Jumpers	3SERVER3.3
Hard Disk Controller Board Connectors/Jumpers ..	3SERVER3.3
Hard Disk Drive Board	3SERVER3.4
Tape Drive Controller Board Connectors/Jumpers ..	3SERVER3.4
Tape Drive	3SERVER3.4

CONTENTS (continued)

3Server386 (26-5552)	3SERVER386.1
Power On Sequence	3SERVER386.2
Control Panel Switches/Buttons	3SERVER386.2
Boot Switch Settings	3SERVER386.3
Internal Cabling	3SERVER386.3
Main Logic Board Jumpers/Connectors	3SERVER386.4
Drive Controller Board	3SERVER386.5
Hard Drive	3SERVER386.5
Tape Drive	3SERVER386.5

FLOPPY DRIVE SECTION

FLOPPY DRIVES - 8"

Shugart 8"	Floppy Drive.2
CDC 8" Discrete	Floppy Drive.2
CDC 8" LSI.....	Floppy Drive.2
TPI 8"	Floppy Drive.2
Tandon 8" in Model 16	Floppy Drive.3
Tandon 8" in Model 12	Floppy Drive.3
Tandon 8" in Expansion Bay	Floppy Drive.3
TM848 Direct Drive Tandon	Floppy Drive.4

FLOPPY DRIVES - 5 1/4"

TEAC FD-54B 5 1/4" (Tandy 1000)	Floppy Drive.4
TEAC FD-55BV 5 1/4" (Tandy 1000EX/SX)	Floppy Drive.4
Tandon TM100-2 5 1/4" (Tandy 1200)	Floppy Drive.5
Tandon TM65-2L (Tandy 1200A)	Floppy Drive.5
Mitsubishi M4853 5 1/4" (Tandy 2000)	Floppy Drive.5
Mitsubishi M4853-1 5 1/4" (Tandy 2000)	Floppy Drive.5
Mitsubishi M4851 5 1/4" (Tandy 3000)	Floppy Drive.5
Mitsubishi MF501A 5 1/4" (Tandy 3000/HL)	Floppy Drive.5
Mitsubishi M4854-347 5 1/4" (Tandy 3000)	Floppy Drive.6
Mitsubishi MF504A 5 1/4" (Tandy 3000/HL)	Floppy Drive.6
Teac FD55BV-221 5 1/4" 360K Floppy Drive	Floppy Drive.6
Teac FD55BR-521 5 1/4" 360K Floppy Drive	Floppy Drive.6
Teac FD55BR-121 5 1/4" 360K Floppy Drive	Floppy Drive.7
Mitsubishi MF504B 5 1/4" 1.2M Floppy Drive	Floppy Drive.7
Mitsubishi MF504C 5 1/4" 1.2M Floppy Drive	Floppy Drive.8

TANDY COMPUTER PRODUCTS

CONTENTS (continued)

FLOPPY DRIVES - 3 1/2"

Teac FD-35-FN 3 1/2" 720K Floppy Drive	Floppy Drive.6
Sony MP-F73W-01D 3 1/2" 1.44M Floppy Drive	Floppy Drive.6
Sony MP-F63-01D 3 1/2" 720K Floppy Drive	Floppy Drive.7
Sony MP-F17W-71 3 1/2" 1.44M Floppy Drive	Floppy Drive.7
Sony MP-F73W-70D 3 1/2" 1.44M Floppy Drive	Floppy Drive.7
Sony MP-F17W-70D 3 1/2" 1.44M Floppy Drive	Floppy Drive.7
Citizen OPBD-12A 3 1/2" 720K Floppy Drive	Floppy Drive.7
Citizen OSDC-95A 3 1/2" 720K Floppy Drive	Floppy Drive.8
Teac FD235F-105U 3 1/2" 720K Floppy Drive	Floppy Drive.8
Teac FD235-136U 3 1/2" 720K Floppy Drive	Floppy Drive.8
Sony MP-F63W-70D 3 1/2" 720K Floppy Drive	Floppy Drive.8
Sony MP-F11W-71 3 1/2" 720K Floppy Drive	Floppy Drive.9
Sony MP-F11W-72 3 1/2" 720K Floppy Drive	Floppy Drive.9
Matsushita EME-213AMC 3 1/2" 720K Floppy Drive .	Floppy Drive.9
Panasonic JU-257A213P 3 1/2" 1.44M Floppy Drive	Floppy Drive.9
Teac FD235HF-106U 3 1/2" 1.44M Floppy Drive	Floppy Drive.10
Matsushita EME-263MG 3 1/2" 1.44M Floppy Drive .	Floppy Drive.10
Sony MFD-17W-72 3 1/2" 1.44M Floppy Drive	Floppy Drive.11

FLOPPY DRIVES - MISC.

2.8" Quick Disk Drive for WP100	Floppy Drive.9
---------------------------------------	----------------

HARD DRIVES SECTION

Notes	Hard Drive.2
-------------	--------------

HARD DRIVES - INTERFACE BOARDS

(26-4150) 8 MEG Interface Board in MII/16/16B/6000	Hard Drive.3
(26-4150) 8 MEG Interface Board in M12	Hard Drive.3
(26-4152/5) 12 MEG Interface Board in MII/16/16B/6000	Hard Drive.3
(26-4152/5) 12 MEG Interface Board in M12	Hard Drive.4
(25-4121) Smart Drive Interface/Controller Adapter	Hard Drive.49

TANDY COMPUTER PRODUCTS

CONTENTS (continued)

HARD DRIVES - CONTROLLER BOARDS

(26-4150)	8 MEG Controller Board	Hard Drive.4
(26-4152/5)	5/12 MEG Controller Board (8X300)	Hard Drive.4
(26-4155W)	15 MEG Internal Controller Board (WD1010)	Hard Drive.4
(25-1025)	External WD1000-TB1 Controller Board	Hard Drive.5
(25-1007)	Xebec Hard Drive Controller (Tandy 1000/1200) ..	Hard Drive.6
(25-1001)	Tandy 1000 WD1002S-WX2 Controller Board	Hard Drive.7
(25-3000)	Tandy 1200 WD1002S-WX2 Controller Board	Hard Drive.8
(25-4060)	Floppy/Hard Drive WD1002-WA2 Controller Board ..	Hard Drive.9
(25-4060)	Floppy/Hard Drive WD1003-WA2 Controller Board ..	Hard Drive.9
(25-4058)	ST506 WD1003-WAH Hard Drive Only Controller	Hard Drive.30
(25-6040)	ST506-MC 5000 HD Controller	Hard Drive.32
(25-3515)	Lite Drive Controller Board	Hard Drive.32
(25-3516)	Lite Drive Controller Board (for 1400FD/HD)	Hard Drive.33
(25-1029/32)	Western Digital Hard Card Controller Board	Hard Drive.33
(25-4121)	Smart Drive Interface/Controller	Hard Drive.49
(90-2450)	WD ESDI Controller for 5KMC	Hard Drive.54
(25-4058)	ST506 WD1003V-MM1 Hard Drive Only Controller ...	Hard Drive.55
(90-2370)	WD AT ESDI Controller	Hard Drive.55

HARD DRIVES - LOGIC BOARDS

(26-4150)	8 MEG Shugart (SA1004) Drive Logic Board	Hard Drive.4
(26-4152/5)	12/15 MEG (TM603/TM503) Drive Logic Board	Hard Drive.5
(26-1130)	5 MEG Tandon (TM602) Drive Logic Board	Hard Drive.5
(25-3000)	10 MEG Tandon (TM502) Drive Logic Board	Hard Drive.5
(25-1025)	10 MEG Tandon (TM-252) Drive Logic Board	Hard Drive.5
(26-4171)	35 MEG Quantum (Q540) Drive Logic Board	Hard Drive.6
(26-4173)	70 MEG Micropolis (1325) Drive Logic Board	Hard Drive.6
(25-4062)	20 MEG Mitsubishi (MR522) Hard Drive Logic PCB .	Hard Drive.8
(25-4062)	20 MEG Seagate (ST225) Hard Drive Logic Board ..	Hard Drive.9
(25-4061)	40 MEG CDC (WREN II) Hard Drive Logic Board	Hard Drive.9
(25-4061)	40 MEG Microscience (HH1050) Drive Logic Board .	Hard Drive.9

HARD DRIVES - DRIVES

(25-4057)	40 MEG Seagate ST251 5 1/4" ST506 Hard Drive ...	Hard Drive.30
(25-4061A)	40 MEG Rodime 3055 3 1/2" ST506 Hard Drive	Hard Drive.31
(25-4067)	70 MEG Rodime 5090 5 1/4" ST506 Hard Drive	Hard Drive.31
(25-4140)	40 MEG Seagate ST151 3 1/2" ST506 HD for 5KMC...	Hard Drive.31
(25-4141)	80 MEG CDC 94355 3 1/2" ST506 HD for 5KMC	Hard Drive.31
(25-3515)	20 MEG CMS (1400LT) 3 1/2" Hard Drive	Hard Drive.32
(25-3516)	20 MEG 3 1/2" Hard Drive for 1400FD/HD	Hard Drive.33

(continued on next page)

TANDY COMPUTER PRODUCTS

CONTENTS (continued)

HARD DRIVES - DRIVES (CONTINUED)

(25-4119)	40 MEG Miniscribe 8051A Smart Drive	Hard Drive.50
(25-4120)	80 MEG Miniscribe 7080A Smart Drive	Hard Drive.50
(25-4151)	150 MEG Half Height ESDI Hard Drive	Hard Drive.53
(25-1045)	20 MEG WD 93028 Smart Drive	Hard Drive.53
(25-1046)	40 MEG WD 93044 Smart Drive	Hard Drive.54
(25-4123)	40 MEG Conner CP3044 Smart Drive	Hard Drive.54
(25-1047)	20 MEG Seagate ST-325X IDE Hard Drive	Hard Drive.60
(25-1048)	40 MEG Seagate ST-351A/X IDE Hard Drive	Hard Drive.60
(25-4124)	52 MEG Quantum LPS52 3 1/2" IDE Hard Drive	Hard Drive.62
(25-4130)	105 MEG Quantum LPS105 3 1/2" IDE Hard Drive	Hard Drive.63
(25-3506/3551)	20 MEG Conner CP-2024 Hard Drive	Hard Drive.66
(25-3552/3571)	60 MEG Conner CP-2064 Hard Drive	Hard Drive.66

HARD DRIVES - HARD CARDS

(25-1029/32)	Western Digital Hard Card Controller Board	Hard Drive.33
(25-1029)	20 MEG Fuji (FK302-26/305-26) Hard Card Logic ..	Hard Drive.35
(25-1029A/B)	20 MEG Hard Card	Hard Drive.36
(25-1032)	20 MEG Hard Card	Hard Drive.38
(25-1032A)	20 MEG Hard Card	Hard Drive.39
(25-1032B)	20 MEG Hard Card	Hard Drive.41
(25-1032C-E)	20 MEG Hard Card	Hard Drive.42
(25-4059/A)	40 MEG Hard Card	Hard Drive.43
(25-4059B)	40 MEG Hard Card	Hard Drive.59

HARD DRIVES - SCSI (Small Computer System Interface)

(25-4161/A/B)	General Notes for all SCSI controllers	Hard Drive.14
(25-4161/A)	16 Bit SCSI HD Controller	Hard Drive.14
(25-4161B)	16 Bit SCSI HD Controller	Hard Drive.20
(25-4159)	40 MEG Quantum 3 1/2" SCSI Hard Drive	Hard Drive.25
(25-4160)	80 MEG Quantum 5 1/4" SCSI Hard Drive	Hard Drive.26
(25-4160A)	80 MEG Quantum 3 1/2" SCSI Hard Drive	Hard Drive.27
(25-4162)	170 MEG CDC 5 1/4" SCSI Hard Drive	Hard Drive.28
(25-4163)	344 MEG CDC 5 1/4" SCSI Hard Drive	Hard Drive.29
(25-6060)	16 Bit SCSI-MC 5000 HD Controller	Hard Drive.32
(25-4164)	202 MEG SCSI Hard Drive	Hard Drive.64
(25-4167)	440 MEG SCSI Hard Drive	Hard Drive.64

TANDY COMPUTER PRODUCTS

CONTENTS (continued)

HARD DRIVES - CARTRIDGE DRIVES

(26-1245)	Disk Cartridge Controller Board	Hard Drive.10
(26-1245)	10 MEG IOMEGA (Alpha-10H) Disk Cart. Drive Logic	Hard Drive.10
(25-4066)	20 MEG IOMEGA (Alpha-20H) Disk Cart. Drive Logic	Hard Drive.10
(25-4064)	20 MEG IOMEGA (Beta 20) Disk Cart. Controller...	Hard Drive.10
(25-4064)	20 MEG IOMEGA (Beta 20) Primary Disk Cartridge..	Hard Drive.10
(25-4065)	20 MEG IOMEGA (Beta 20) Secondary Disk Cartridge	Hard Drive.11
(25-5147)	Disk Cartridge Interface for Tandy 20000	Hard Drive.11
(25-3022)	Disk Cartridge Interface for 10000/12000/30000	Hard Drive.11
(25-4064)	PC2B Disk Cart. Interface for 10000/12000/30000 ...	Hard Drive.11
(25-4064A)	20 MEG Internal Disk Cartridge System "A" Vers..	Hard Drive.45

HARD DRIVES - CD ROM DRIVES

(25-1081)	Hitachi CD ROM Player and Interface	Hard Drive.56
(25-1077)	Mitsumi CDR-10000 CD-ROM Player and Interface ...	Hard Drive.57
(90-2156)	Hitachi Ext. CDR-1503S CD-ROM Player and I/F ...	Hard Drive.57
(903-2376)	Hitachi Ext. CDR-1700S CD-ROM Player and I/F ...	Hard Drive.58

HARD DRIVES - TAPE CARTRIDGE

(25-3020)	TCS-100 Tape Cartridge Controller Board	Hard Drive.12
(25-3020)	TCS-100 Tape Cartridge Drive Logic Board	Hard Drive.12
(25-3020)	TCS-100 Tape Cartridge Drive Logic Board Rev. C2	Hard Drive.12
(25-3021)	TCS-100 Tape Cartridge I/F for 10000/12000/30000 ..	Hard Drive.13
(25-4169)	150 MEG 5 1/4" SCSI Tape Drive	Hard Drive.44
(25-4069)	40 MEG Internal Tape Cartridge System	Hard Drive.46
(25-4069A)	40 MEG Internal Tape Cartridge System "A" Vers..	Hard Drive.46
(25-4079)	60 MEG Internal Tape Cartridge System	Hard Drive.47
(90-2060)	Scorpion 60 MEG Internal Tape Cartridge System..	Hard Drive.48
(90-2060)	Long Interface Board SC-499	Hard Drive.48
(90-2060)	Short Interface Board SC-499R	Hard Drive.48
(25-4166)	160 MEG SCSI Tape Cassette System	Hard Drive.65

UPGRADE BOARD SECTION

UPGRADE BOARDS - CONTROLLERS

(26-5127)	Tandy 20000 Hard Drive Controller Board	Upgrade Board.5
(25-4060)	Floppy/Hard Drive WD1002-WA2 Controller Board ..	Upgrade Board.19
(25-4060)	Floppy/Hard Drive WD1003-WA2 Controller Board ..	Upgrade Board.19
(25-1060)	Tandy 1000EX/HX External Floppy Disk Interface..	Upgrade Board.19

TANDY COMPUTER PRODUCTS

CONTENTS (continued)

UPGRADE BOARDS - CPU

	68000 6 MHz CPU Board	Upgrade Board.3
	68000 6 MHz CPU Board (reduced size)	Upgrade Board.3
(26-6014)	8 MHz 68000 CPU Board	Upgrade Board.3
	68000 MMU Board (see Model 6000 chapter)	Model 6000.4

UPGRADE BOARDS - MEMORY

(26-4105)	Visicalc 64K Memory Board	Upgrade Board.2
(26-6503)	144K board for Visicalc	Upgrade Board.2
(26-6011)	128K/256K 68000 Memory Board (1st - 4th)	Upgrade Board.3
(26-6014)	512K/1MEG 68000 RAM Board with 512K	Upgrade Board.3
(26-6014)	512K/1MEG 68000 RAM Board with 1MEG	Upgrade Board.4
(25-1004)	Tandy 1000 First External RAM Board	Upgrade Board.4
(25-1009)	Tandy 1000 Second External RAM Board	Upgrade Board.4
(26-5161)	Tandy 2000 First External RAM Board	Upgrade Board.5
(26-5161)	Tandy 2000 Second External RAM Board	Upgrade Board.5
(25-3061)	Tandy 1200 Captain Multi-Function Board	Upgrade Board.6
(25-1011)	Tandy 1000 Memory Plus Board	Upgrade Board.7
(25-4030)	Tandy 3000 2 MEG Memory Expansion Board	Upgrade Board.7
(25-1062)	Tandy 1000EX/HX Memory PLUS Expansion Adapter ..	Upgrade Board.18
(25-4027)	0K Mem. Exp. Adapter for 3000NL without jumper..	Upgrade Board.30
(25-4027)	0K Mem. Exp. Adapter for 3000NL with jumper	Upgrade Board.30
(25-6030)	0K Memory Expansion Adapter for the 5000MC	Upgrade Board.31
(25-5030)	32 Bit Memory Board for the 4000/LX	Upgrade Board.31
(25-5029)	32 Bit Memory Board for the 4000/LX	Upgrade Board.31
(25-3554)	1 MB Memory Upgrade Board for 2800HD	Upgrade Board.31
(25-4930)	Memory Adapter for 4000SX	Upgrade Board.31
(25-3507)	1 MEG Memory Expansion SIMM (1500/2810/3810) ...	Upgrade Board.45

UPGRADE BOARDS - MISCELLANEOUS

(25-1035)	Tandy 286 Express Board	Upgrade Board.4
(26-5144)	Tandy 2000 Digi-Mouse/Clock Board	Upgrade Board.6
(25-1030)	Enhanced Keyboard Adapter	Upgrade Board.22
(25-4038)	Enhanced Keyboard.....	Upgrade Board.22
(25-1028)	Trackstar 128 Interface Board	Upgrade Board.46
(25-1038)	Trackstar E Interface Board	Upgrade Board.46
(90-2405)	CMS Tape Drive Mux Adapter	Upgrade Board.47

TANDY COMPUTER PRODUCTS

CONTENTS (continued)

UPGRADE BOARDS - MODEMS

(25-1003)	Tandy 1000 300 Baud Modem Board	Upgrade Board.19
(25-1013)	Internal 1200 Baud Modem Revision A, B, & C	Upgrade Board.19
(25-1013D/E)	Internal 1200 Baud Modem Revision D, E	Upgrade Board.20
(25-1018)	PLUS 1200 Baud Modem	Upgrade Board.20
(25-1018A)	PLUS 1200 Baud Modem Revision A	Upgrade Board.21
(25-1037/A)	2400 Baud Half Card Modem Board	Upgrade Board.21
(25-3510)	LT1400 Internal Modem Board	Upgrade Board.22
(25-1017)	Plus 300 Baud Modem.....	Upgrade Board.23
(25-3063)	Faxmate board	Upgrade Board.32
(25-1034)	2400-bps Error-Corrected Modem	Upgrade Board.33
(25-3538)	2400-bps Internal Modem for 1100FD	Upgrade Board.33
(25-3524)	2400-bps Internal Modem for 1400 FD/HD	Upgrade Board.34
(25-1037B)	2400-bps Half Card Modem Revision B	Upgrade Board.39
(25-3525)	2400 Baud Modem for 1500/2810/3810 Laptops	Upgrade Board.39
(25-3555)	2400 Baud Modem for 2800HD Laptop	Upgrade Board.39
(25-1013F)	Internal 1200 Baud Modem Revision F	Upgrade Board.39

UPGRADE BOARDS - NETWORK

(26-6501)	Arcnet Board	Upgrade Board.2
(26-6503)	144K board for Arcnet	Upgrade Board.2
(26-1221)	Vianet Board for the Tandy 1000/1200/3000/HL ...	Upgrade Board.16
(26-1220)	Vianet Board for the Tandy 2000	Upgrade Board.16
(25-1019)	PLUS Network 4 Interface.....	Upgrade Board.19
(26-5435)	Etherlink I Network Interface "Original Style" .	Upgrade Board.24
(26-5435)	Etherlink I Network Interface "Late Style"	Upgrade Board.25
(26-5501)	Etherlink II Network Interface Board	Upgrade Board.26
(26-5502)	Etherlink Plus Network Interface Board	Upgrade Board.27
(26-5602/1)	Tandylink/PLUS Boards	Upgrade Board.27
(26-6505)	Tandy Arcnet Adapter Board	Upgrade Board.34
(26-5540)	Tandy Token Ring Adapter Board	Upgrade Board.36
(26-5505)	Tandy Ethernet Adapter Board	Upgrade Board.36
(26-5505A/B)	Tandy Ethernet Adapter Board	Upgrade Board.38
(26-5506)	Tandy Ethernet Plus Adapter	Upgrade Board.37

UPGRADE BOARDS - SERIAL/PARALLEL

(26-6013)	Multi-Terminal Board - 1st board	Upgrade Board.2
(26-6013)	Multi-Terminal Board - 2nd board	Upgrade Board.2
(25-1006)	Tandy 1000 RS-232C Board	Upgrade Board.4
(25-3061)	Tandy 1200 Captain Multi-Function Board	Upgrade Board.6
(25-1014)	RS-232 PLUS Interface Board	Upgrade Board.14

(continued on next page)

TANDY COMPUTER PRODUCTS

CONTENTS (continued)

UPGRADE BOARDS - SERIAL/PARALLEL (CONTINUED)

(25-1031)	RS-232 PLUS Interface Board (2nd Version)	Upgrade Board.15
(26-5164)	Tandy 2000 Serial Expansion Board	Upgrade Board.15
(25-4031)	Multi-Terminal Board for the Tandy 3000	Upgrade Board.17
(25-4034)	Serial/Parallel Board Revision A	Upgrade Board.17
(25-4034)	Serial/Parallel Board Revisions B and C	Upgrade Board.17
(25-4039)	Dual Port Serial Board.....	Upgrade Board.23
(90-2185/6)	ARNET 4/8 Port Boards	Upgrade Board.28
(25-4025)	Dual Serial/Parallel Board	Upgrade Board.39
(25-4025A)	Dual Serial/Parallel Board	Upgrade Board.40
(90-2403)	ARNET Smartport 16 Port Board	Upgrade Board.42
(90-2453)	ARNET Multiport 4 Port Board	Upgrade Board.43
(90-2458)	ARNET Octaport 8 Port Board	Upgrade Board.44
(26-2829)	Serial/Parallel Converter	Upgrade Board.45

UPGRADE BOARDS - VIDEO

(26-4104)	Graphics Board	Upgrade Board.2
(26-5140)	Tandy 2000 Monochrome Graphics Board	Upgrade Board.5
(26-5140)	Tandy 2000 Color Graphics Board	Upgrade Board.5
(25-3043)	Tandy 1200 Graphics Tender Board	Upgrade Board.8
(25-3044)	Tandy 1200 Graphics Master Board	Upgrade Board.8
(25-3045)	Dual Display Graphics Adapter Board	Upgrade Board.9
(25-3045A)	Dual Display Graphics Adapter Revision A	Upgrade Board.9
(25-3046)	Deluxe Text Display Adapter	Upgrade Board.9
(25-3046B)	Deluxe Text Display Adapter Revision B	Upgrade Board.9
(25-3046C)	Deluxe Text Display Adapter Revision C	Upgrade Board.9
(25-3047)	Deluxe Graphics Display Adapter	Upgrade Board.10
(25-3048)	EGA/CGA Graphics Adapter	Upgrade Board.10
(25-3048A)	EGA/CGA Graphics Adapter Revision A	Upgrade Board.11
(25-4043)	VGA Adapter Board	Upgrade Board.13
(25-4037)	EGA Enhanced Graphics Adapter Board	Upgrade Board.13
(25-3049)	Monochrome/parallel Adapter board	Upgrade Board.31
	16 Bit VGA Adapter board	Upgrade Board.33
	16 Bit Super VGA Adapter Board	Upgrade Board.46

TANDY COMPUTER PRODUCTS

APPENDIX Appendix.1
 TRS-DOS System Floppy Drive Usage (8") .. Appendix.2
 TRS-DOS Upgrade Board Usage Appendix.2
 TRS-DOS System Hard Drive Usage Appendix.2
 TRS-DOS Hard Drives Used In MS-DOS CPUs . Appendix.3
 MS-DOS System Floppy Drive Usage (5 1/4") Appendix.3
 MS-DOS System Floppy Drive Usage (3 1/2") Appendix.4
 Hard Card Heads and Cylinders Appendix.4
 ST-506 Hard Drive Heads and Cylinders ... Appendix.5
 IDE Hard Drive Heads and Cylinders Appendix.6
 SCSI Hard Drive Heads and Cylinders Appendix.6
 Hard Drive Types Appendix.7
 TANDY 5000MC Hard Drive Type Table Appendix.8
 MS-DOS Upgrade Board Usage Appendix.10
 RAM Reference Guide Appendix.12
 SIMM ID Table Appendix.13
 Tandy/GriD Catalog/Model # Cross Ref..... Appendix.15
 Monitor Type Table Appendix.15
 Video Monitor/Video Board
 Compatibility Chart..... Appendix.16
 Diagnostic Beep Codes Appendix.18
 Decimal-Binary-Hexadecimal Chart Appendix.19
 ASCII Character Code Table Appendix.20
 VGA Pin Outs Appendix.21
 DB25 Parallel Port Pin Outs Appendix.21
 DB9 Serial Port Pin Outs Appendix.21

LIST OF FIGURES

Description	Figure
CPU Board Model II (Rev. A-C)	1
CPU Board Model II/16 (Rev. D)	2
Keyboard/Video Board (Early Style)	3
Keyboard/Video Board (Late Style)	4
Keyboard/Video Board (Model 12/16B)	5
FDC Board (Early Style)	6
FDC Board (Late Style for Model II)	7
FDC Board (Late Style for Model 16)	8
First 32K Memory Board	9
Second 32K Memory Board	10
First 64K Memory Board (26-4105).....	11
Visicalc 64K Memory Board (26-4105).....	12
144K Memory Board for Arcnet (26-6503).....	13
144K Memory Board for Visicalc (26-6503).....	14
Model 12 Main Logic Board	15
68000 6 MHz CPU board	16
Reduced Size 68000 6 MHz CPU board	17
128K/256K 68000 Memory Board (26-6011).....	18

(continued on next page)

TANDY COMPUTER PRODUCTS

LIST OF FIGURES (cont.)

Description	Figure
8 MEG Hard Disk Interface In Model II/16/16B	19
8 MEG Hard Disk Interface In Model 12	20
12 MEG Hard Disk Interface In Model II/16/16B	21
12 MEG Hard Disk Interface In Model 12	22
8 MEG Hard Disk Controller Board	23
5/12/External 15 MEG Hard Disk Controller Board	24
8 MEG Hard Disk Drive Logic Board	25
12/15 MEG Hard Disk Drive Logic Board	26
5 MEG Hard Disk Drive Logic Board	27
Arcnet Board (26-6501).....	28
Hi-Res Graphics Board (26-4104).....	29
Tandon Thinline Floppy Disk Drive Logic Board	30
Multi-Terminal Board (26-6013).....	31
Shugart 8" Floppy Disk Drive Logic Board (Discrete)	32
Shugart 8" Floppy Disk Drive Logic Board (Early LSI)	33
Shugart 8" Floppy Disk Drive Logic Board (Late LSI)	34
CDC 8" Floppy Disk Drive Logic Board (Discrete)	35
CDC 8" Floppy Disk Drive Logic Board (LSI)	36
TPI 8" Floppy Disk Drive Logic Board	37
15 MEG Hard Disk Internal Controller/Interface Board	38
Model 16B Main Logic Board	39
Mitsubishi 5 1/4" Floppy Disk Drive Logic Board	40
TM848 Direct Drive Tandon Floppy Disk Drive Logic	41
Tandy 1000 Main Logic Board	42
TEAC FD-54B 5 1/4" Floppy Drive Logic Board (in Tandy 1000)	43
Tandy 1200 Main Logic Board	44
Tandy 1200 Floppy Disk Controller Board	45
Tandy 1200 Hard Disk Controller Board	46
Tandon TM100-2 5 1/4" Floppy Drive Logic (in Tandy 1200) ...	47
10 MEG Hard Drive Logic Board	48
Tandy 2000 Main Logic Board	49
Mitsubishi M4853-1 5 1/4" Floppy Drive Logic (in Tandy 2000)	50
35 MEG Hard Drive Logic Board	51
WD1010 External Hard Drive Controller Board	52
Tandy 1000 300 Baud Modem Board (25-1003).....	53
Tandy 1000 RS-232 Board (25-1006).....	54
Tandy 1000 First External RAM Board (25-1004).....	55
Tandy 1000 Second External RAM Board (25-1009).....	56
Tandy 1200 Captain Multi-Function Board (25-3061).....	57
Tandy 1200 Graphics Tendor Board (25-3043).....	58
Tandy 1200 Graphics Master Board (25-3044).....	59
Tandy 2000 Internal Hard Drive Controller Board (26-5127)...	60
Tandy 2000 Monochrome Graphics Board (26-5140).....	61
Tandy 2000 Color Graphics Board (26-5140).....	62

(continued on next page)

TANDY COMPUTER PRODUCTS

LIST OF FIGURES (cont.)

Description	Figure
Tandy 20000 First External RAM Board (26-5161).....	63
Tandy 20000 Second External RAM Board (26-5161).....	64
Tandy 20000 Digi-Mouse/Clock Board (26-5144).....	65
8 MHz 68000 CPU Board (26-6014).....	66
512K/1MEG 68000 RAM board with 512K (26-6014).....	67
512K/1MEG 68000 RAM board with 1MEG (26-6014).....	68
Tandy 10000 Xebec Hard Drive Controller Board (25-1007).....	69
70 MEG Micropolis Hard Drive Logic Board	70
Vianet Board for Tandy 10000 and Tandy 12000 (26-1221).....	71
Vianet Board for Tandy 20000 (26-1220).....	72
Disk Cartridge Controller Board	73
Disk Cartridge Drive Logic Board	74
Interface Board for Tandy 10000/12000 with Disk Cartridge	75
10 MEG Thinline (TM-252) Hard Drive Logic Board	76
Tandy 10000 WD1010 Controller Board	77
Tape Cartridge Controller Board	78
Tape Cartridge Drive Logic Board	79
Tape Cartridge Interface Board to the Tandy 10000/12000	80
Tandy 10000 Memory Plus Board (25-1011).....	81
Tandy 10000 Internal 1200 Baud Modem (25-1013).....	82
Tandy 10000A Main Logic Board	83
Tandy 12000A Main Logic Board	84
4K Model III Main Logic Board	85
16K/32K/48K Model III Main Logic Board	86
Model III/4 Early FDC Board	87
16K Model 4 Standard PCB	88
64K/128K Model 4 Standard PCB	89
64K/128K Model 4 Gate Array PCB	90
64K/128K Model 4D Main Logic Board	91
Tandy 20000 Serial Expansion Board (SDLC) (26-5164).....	92
Tandy 30000 Main Logic Board	93
Tandy 30000 Floppy Disk Controller Board	94
Tandy 30000 Floppy/Hard Disk Controller Board (25-4036)	95
Mitsubishi M4851 Floppy Drive Logic Board (25-4060)	96
Mitsubishi M4854-347 Floppy Drive Logic Board	97
Tandon TM65-2L Floppy Drive Logic Board	98
Tandy 12000 WD1010 (short) Hard Drive Controller Board	99
20 MEG Mitsubishi (MR522) Hard Drive Logic Board	100
20 MEG Seagate (ST225) Hard Drive Logic Board	101
Tandy 30000 Serial/Parallel Board (25-4034A)	102
Tandy 30000 2 MEG Memory Board (25-4030)	103
Deluxe Text Display Adapter (Tandy 12000/30000) (25-3046).....	104
Deluxe Graphics Display Adapter (Tandy 12000/30000) (25-3047).....	105
RS-232 Plus Interface Board (25-1014).....	106

(continued on next page)

TANDY COMPUTER PRODUCTS

LIST OF FIGURES (cont.)

Description	Figure
TEAC FD-55BV Floppy Drive Logic Board	107
Mitsubishi MF501A Floppy Drive Logic Board	108
Mitsubishi MF504A Floppy Drive Logic Board	109
40 MEG CDC (WREN II) Hard Drive Logic Board	110
PC2B Disk Cartridge Interface Board	111
Tandy 2000 Disk Cartridge Interface Board	112
Tape Cartridge Drive Logic Board Revision C2	113
Vianet (Arcnet-PC100) Board (1000/1200/3000) (26-1221)	114
Serial/Parallel Board Revision B/C (25-4034B/C)	115
Dual Display Graphics Adapter Video Board (25-3045).....	116
Tandy 3000 Multi-Terminal Board (25-4031).....	117
20 MEG IOMEGA (Alpha-20H) Disk Cartridge PCB	118
Tandy 3000 Gate Array Main Logic Board	119
Tandy 1000EX Main Logic Board	120
Tandy 1000SX Main Logic Board	121
Tandy 3000HL Main Logic Board	122
Tandy 1000EX Memory PLUS Expansion Adapter (25-1062)	123
Floppy/Hard Drive WD1003-WA2 Controller Board (25-4060)	124
1000 External Floppy Disk Interface (25-1060)	125
Plus Network 4 Interface (25-1019)	126
Plus 1200 Baud Modem (25-1018)	127
Enhanced Keyboard Adapter (25-1030)	128
Enhanced Keyboard (25-4038)	129
Dual Port Serial Board (25-4039)	130
Plus 300 Baud Modem (25-1017)	131
Teac FD-35-FN 3 1/2" 720K Floppy Drive	132
40 MEG Microscience (HH-1050) Drive Logic Board	133
Western Digital Hard Card Controller Board	134
Tandy 1000HX Main Logic Board	135
Tandy 1000TX Main Logic Board	136
Tandy 3000 (12MHZ) Main Logic Board	137
Tandy 4000 Main Logic Board	138
Tandy 3000HL with Key Lock Main Logic Board	139
Plus RS232 (25-1031)	140
Sony MP-F73W-01D 3 1/2" 1.44 Meg Floppy Drive	141
Sony MP-F73W-70D 3 1/2" 1.44 Meg Floppy Drive	141
Sony MP-F17W-70D 3 1/2" 1.44 Meg Floppy Drive	141
Sony MP-F17W-71 3 1/2" 1.44 Meg Floppy Drive	141
Sony MP-F17W-72 3 1/2" 1.44 Meg Floppy Drive	141
Teac FD55BV-221 5 1/4" 360K Floppy Drive	142
Teac FD55BR-521 5 1/4" 360K Floppy Drive	143

(continued on next page)

TANDY COMPUTER PRODUCTS

LIST OF FIGURES (cont.)

Description	Figure
Sony MP-F63-01D 3 1/2" 720K Floppy Drive	144
Sony MP-F63-70D 3 1/2" 720K Floppy Drive	144
Sony MP-F11W-70D 3 1/2" 720K Floppy Drive	144
Sony MP-F11W-71 3 1/2" 720K Floppy Drive	144
Sony MP-F11W-72 3 1/2" 720K Floppy Drive	144
Etherlink Network Interface Board (26-5435)	145
Etherlink Plus Network Interface Board (26-5502)	146
20 MEG Fuji (FK302-26/305-26) Hard Card Logic Board	147
20 MEG Miniscribe (8438) Hard Card Logic Board	148
Enhanced Graphics Adapter (25-4037)	149
20 MEG IOMEGA (Beta 20) Disk Cartridge Controller	150
20 MEG IOMEGA (Beta 20) Primary Disk Cartridge	151
20 MEG IOMEGA (Beta 20) Secondary Disk Cartridge	152
Dual Display Graphics Adapter (25-3045A)	153
Mitsubishi MF504B 1.2 Meg Floppy Drive	154
Model 4P Standard Main Logic Board	155
Model 4P Gate Array Main Logic Board	156
68000 MMU board	157
512K/1MEG 68000 memory board with 512K	158
512K/1MEG 68000 memory board with 1 MEG	159
Citizen OSDC-95A 3 1/2" Floppy Drive 720K	160
16 Bit SCSI HD Controller (25-4161)	161
40 MEG Quantum 3 1/2" SCSI Hard Drive (25-4159)	162
80 MEG Quantum 3 1/2" SCSI Hard Drive (25-4160)	162
80 MEG Quantum 5 1/4" SCSI Hard Drive (25-4160A)	163
170 MEG 5 1/4" SCSI Hard Drive (25-4162)	164
344 MEG 5 1/4" SCSI Hard Drive (25-4163)	165
ST506 WD1003 WAH Hard Drive Only Controller (25-4058)	166
40 MEG Seagate ST251 5 1/4" ST506 Hard Drive (25-4057)	167
40 MEG Rodime 3055 3 1/2" ST506 Hard Drive (25-4061A)	168
70 MEG Rodime 5090 5 1/4" ST506 Hard Drive (25-4067)	169
40 MEG Seagate ST151 3 1/2" ST506 HD for 5KMC (25-4140)	170
80 MEG CDC 94355 3 1/2" ST506 HD for 5000MC (25-4141)	171
16 Bit SCSI-MC 5000 HD Controller (25-6060)	172
ST506-MC 5000 HD Controller (25-6040)	173
20 MEG CMS (1400 LT) 3 1/2" Hard Drive (25-3515)	174
Lite Drive Controller Board (25-3515)	175
20 MEG Mini Scribe 8438 Hard Card (25-1029A/B)	176
20 MEG Tandon TM362 Hard Card (25-1032/A/B)	177
20 MEG Western Digital WD362 Hard Card (25-1032/A/B)	177
20 MEG Western Digital 93028 Hard Card (25-1032C)	178
40 MEG Seagate 157 Hard Card Controller Board (25-4059)	179
40 MEG Seagate 157 Hard Card (25-4059)	180
150 MEG 5 1/4" SCSI Tape Drive (25-4169)	181
20 MEG Internal DCS "A" Vers - BETA I (25-4064A).....	182

(continued on next page)

TANDY COMPUTER PRODUCTS

LIST OF FIGURES (cont.)

Description	Figure
4Ø MEG Internal Tape Cartridge System (25-4Ø69)	183
4Ø MEG Internal Tape Cartridge System "A" Vers. (25-4Ø69A)..	183
Scorpion 6Ø MEG Internal Tape Cartridge System (9Ø-2Ø6Ø) ...	184
Long Interface Board SC-499 (9Ø-2Ø6Ø)	185
Short Interface Board SC-499R (9Ø-2Ø6Ø)	186
286 Express Board for Tandy 1ØØØ family (25-1Ø35)	187
Deluxe Text Display Adapter Rev. B (25-3Ø46B AX-Ø189)	188
Deluxe Text Display Adapter Rev. C (25-3Ø46C AX-Ø233)	188
EGA/CGA Video Board (25-3Ø48)	189
EGA/CGA Video Board "A" Version (25-3Ø48A)	19Ø
VGA Graphics Adapter Board (25-4Ø43)	191
12ØØ Baud Internal Modem Board Revision D/E (25-1Ø13D/E) ..	192
12ØØ Baud PLUS Modem Board Revision A (25-1Ø18A)	193
24ØØ Baud Internal Modem Board (25-1Ø37/A)	194
12ØØ Baud LT14ØØ Internal Modem Board (25-351Ø)	195
ARNET Smartport 4 Board (9Ø-2185)	196
ARNET Smartport 8 Board (9Ø-2186)	197
Tandylink Board (26-56Ø1)	198
Tandylink PLUS Board (26-56Ø2)	198
ØK Memory Exp. Adapter for Tandy 3ØØØNL W/jumper (25-4Ø27)..	199
ØK Memory Exp. Adapter for Tandy 3ØØØNL without jumper	2ØØ
ØK Memory Exp. Adapter for Tandy 5ØØØMC (25-6Ø3Ø)	2Ø1
32 Bit Memory Board for Tandy 4ØØØ/LX (25-5Ø29/3Ø)	2Ø2
Tandy 1ØØØSL Main Logic Board (25-14Ø1)	2Ø3
Tandy 1ØØØTL Main Logic Board (25-16Ø1)	2Ø4
Tandy 1ØØØTX Revision A (Cleburn Version) (25-16ØØ)	2Ø5
Tandy 3ØØØNL Main Logic Board (25-4Ø72)	2Ø6
Tandy 4ØØØLX Main Logic Board (25-51ØØ)	2Ø7
Tandy 5ØØØMC Main Logic Board (25-6ØØØ)	2Ø8
Tandy 5ØØØMC CPU Board (25-6ØØØ)	2Ø9
Etherlink II Network Interface Board (26-55Ø1)	21Ø
Teac FD55BR-121 Floppy Disk Drive (25-1Ø63A)	211
16 Bit SCSI Hard Drive Controller "B" version (25-4161B) ...	212
Citizen OPBD-12A Floppy Disk Drive	213
Tandy 4ØØØSX Main Logic Board (25-49ØØ)	214
Teac FD235-1Ø5U 3 1/2" Floppy Drive	215
Mitsubishi MF5Ø4C-347UA 5 1/4"	216
EME-213 3 1/2" Floppy Drive 72ØK	217
Teac FD235-136U 3 1/2" Floppy Drive 72ØK	218
Panasonic JU-257A213P 1.44 MEG Floppy Drive	219
WP2 Main Logic Board/32K Mem Upgrade/32K Mem Card	22Ø
16 Bit VGA Adapter Board	221
WD 1ØØ3V-MM1 Hard Drive Controller	222
Tandy 1ØØØSL/2 Revision C Main Logic Board	223
Tandy 1ØØØSL/2 Revision D Main Logic Board	224

(continued on next page)

TANDY COMPUTER PRODUCTS

LIST OF FIGURES (cont.)

Description	Figure
Tandy 1000TL/2 Main Logic Board	225
Tandy 1400LT/A Main Logic Board	226
Tandy 1400LT "B" Version Main Logic Board	227
Tandy 1400FD/HD Main Logic Board	228
WP-100 Main Logic Board	229
40 MEG Miniscribe 8051A 3 1/2" Smart Drive	230
80 MEG Miniscribe 7080A 3 1/2" Smart Drive	231
150 MEG Half Height ESDI Hard Drive Logic Board	232
20/40 MEG IDE Smart Drive	233
Hard Drive and Controller for Tandy 1400FD/HD	234
Tandy 2500XL Main Logic Board	235
Tandy 4016DX/4020/25/33LX Main Logic Board	236
Tandy 4016DX CPU Board	237
Tandy 4020/25/33LX CPU Board	238
Tandy 4016SX Main Logic Board	239
Tandy 1100FD Main Logic Board - Solder Side	240
Tandy 2800HD Main Logic Board	241
Conner CP-3024 (20 MEG) and CP-3044 (40 MEG) HD Logic Board.	242
60 MEG 5 1/4" Internal Tape Drive	243
Hitachi CD ROM player and Interface	244
Monochrome/parallel Adapter Board (25-3049)	245
Smart Drive Interface Adapter Board	246
Trackstar 128/E Interface Board (25-1028/1038)	247
Tandy Ethernet Adapter Board (26-5505)	248
Tandy Ethernet 1 New style (26-5435)	249
Tandy Token Ring Adapter Board (26-5540)	250
Tandy Arcnet Adapter Board (26-6505)	251
Serial Parallel Converter Boards (26-2829).....	252
Tandy 2400 Baud Error Correcting Modem Board (25-1034)	253
Tandy 1400LT/FD/HD 2400 Baud Internal Modem Board (25-3524).	254
Tandy 1100FD Internal Modem Board (25-3538)	255
2400 Baud Internal Modem for 2800HD (25-3555)	256
Tandy Faxmate Board (25-3063)	257
Western Digital ESDI Controller for AT style computers	258
Western Digital ESDI Controller for Tandy 5000MC	259
Memory Adapter Board for Tandy 4000SX (25-4930)	260
1 MEG Memory Upgrade Board for Tandy 2800HD	261
20 MEG MiniScribe 8438 Hard Card Version 3	262
2.8" Quick Drive for WP100	263
WD344 40 Meg Hard Card Hard Drive	264
Adaptec ST506 Hard Drive Controller for T5000MC	265
20 MEG Internal DCS "A" Vers - BETA L (25-4064A).....	266
Tandy 1500 Main Logic Board	267
Tandy 2810 Main Logic Board	268

(continued on next page)

TANDY COMPUTER PRODUCTS

LIST OF FIGURES (cont.)

Description	Figure
Tandy 4020SX Main Logic Board	269
Tandy 2500XL/2 Main Logic Board	270
Tandy 1000TL/3 Main Logic Board	271
Tandy 1000RL/HD Main Logic Board and SSJ Board	272
Tandy 1000RLX/HD Main Logic Board and SSJ Board	273
Tandy 3810 Main Logic Board	274
Teac 235HF-106U 3 1/2" 1.44 Meg Floppy Drive	275
Tandy 2500SX Main Logic Board	276
CMS Tape Drive Mux Adapter	277
1 Meg EMS Memory Expansion SIMM	278
2400 Baud Modem Board for 2800 (25-3555)	279
2400 Baud Modem Board for 1500/2810/3810 Laptops (25-3525) .	280
Internal 1200 Baud Modem Board Revision F	281
Tandy Ethernet Plus Adapter Board (25-5506)	282
Conner CP-2064 60 Meg IDE Hard Drive	283
Tandy 1000EX Revision D Main Logic Board	284
Tandy Etherlink Board (25-5505A/B)	285
Dual Serial/Parallel Board Revision Blank (25-4025)	286
Dual Serial/Parallel Board Revision A (25-4025A)	287
Arnet Multiport 4 Board (90-2453)	288
Arnet Octaport 8 Board (90-2458)	289
Arnet Smartport 16 Board (90-2403)	290
2400 Baud Half Card Modem Board Revision B (25-1037B)	291
Seagate ST-325X 20 Meg IDE Hard Drive	292
Seagate ST-351A/X 40 Meg IDE Hard Drive	293
Quantum LPS52 52 Meg Smart Drive	294
Quantum LPS105 105 Meg Smart Drive	294
202 Meg SCSI Hard Drive	295
440 Meg SCSI Hard Drive	296
160 Meg SCSI Tape Drive	297
16 Bit Super VGA Adapter Board	298
Conner CP-2024 20 Meg IDE Hard Drive	299
Matsushita EME-263MG 1.44M Floppy Drive	300
3SERVER3 Main Unit/Control Panel	301
3SERVER3 Main Logic Board	302
3SERVER3 Disk Drive Controller Board	303
3SERVER3 Priam Hard Disk Drive	304
3SERVER3 Tape Drive Controller Board	305
3SERVER3 Wangtek Tape Drive	306
3S/401 Main Unit Control Panel	307
3S/401 Main Logic Board	308
3S/401 Hard/Tape Drive Controller Board	309
3S/401 CDC Hard Drive	310
3S/401 Tandberg Tape Drive	311
Mitsumi CDR-1000 CD-ROM Drive and Interface	312
Hitachi External CD-ROM Drive 1700S (90-2156) and I/F	313
Hitachi External CD-ROM Drive 1503S (903-2376) and I/F	314

TANDY COMPUTER PRODUCTS

Upgrade Boards Quick Reference by Catalog Number

This list is NOT all inclusive but is provided as an aid when identifying boards that are similar in description.

Catalog Number	Description	Figure #	Text
25-1003	Tandy 1000 300 Baud Modem	53	Upgrade.19
25-1004	Tandy 1000 First External Ram Board	55	Upgrade.4
25-1006	Tandy 1000 RS-232 Board	54	Upgrade.4
25-1009	Tandy 1000 Second External Ram Board	56	Upgrade.4
25-1011	Tandy 1000 Memory Plus Board	81	Upgrade.7
25-1013	Tandy 1000 Internal 1200 Baud Modem	82	Upgrade.19
25-1013D/E	Tandy 1000 Internal 1200 Bd Modem Rev. D/E	192	Upgrade.20
25-1013F	Tandy 1000 Internal 1200 Baud Modem Rev. F	281	Upgrade.39
25-1014	RS-232 Plus Interface Board	106	Upgrade.14
25-1017	PLUS 300 Baud Modem	131	Upgrade.23
25-1018	PLUS 1200 Baud Modem	127	Upgrade.20
25-1018A	PLUS 1200 Baud Modem Board Rev. A	193	Upgrade.21
25-1019	PLUS Network 4 Interface	126	Upgrade.19
25-1028	Trackstar 128	247	Upgrade.46
25-1030	Enhanced Keyboard Adapter	128	Upgrade.22
25-1031	Plus RS232	140	Upgrade.15
25-1034	2400 Baud Error Correcting Modem	253	Upgrade.33
25-1035	Tandy 286 Express Board	187	Upgrade.4
25-1037/A	2400 Baud Modem Board	194	Upgrade.21
25-1037B	2400 Baud Modem Board	291	Upgrade.39
25-1038	Trackstar E	247	Upgrade.46
25-1062	Tandy 1000EX Memory Plus Expansion Adapter	123	Upgrade.18
25-3043	Tandy 1200 Graphics Tendor Board	58	Upgrade.8
25-3044	Tandy 1200 Graphics Master Board	59	Upgrade.8
25-3045	Dual Display Graphics Adapter	116	Upgrade.9
25-3045A	Dual Display Graphics Adapter Rev. A	153	Upgrade.9
25-3046	Deluxe Text Display Adapter	104	Upgrade.9
25-3046B/C	Deluxe Text Display Adapter Vers. B & C	188	Upgrade.9
25-3047	Deluxe Graphics Display Adapter	105	Upgrade.10
25-3048	EGA/CGA Graphics Adapter	189	Upgrade.10
25-3048A	EGA/CGA Graphics Adapter Vers. A	190	Upgrade.11
25-3049	Monochrome/Parallel Adapter Board	245	Upgrade.31
25-3061	Captain Multifunction Board	57	Upgrade.6
25-3063	Tandy FAXMATE Board	257	Upgrade.32
25-3507	1 MEG Memory Exp. SIMM for 1500/2810/3810	278	Upgrade.45
25-3510	LT1400 Internal Modem Board	195	Upgrade.22
25-3524	2400 Baud Internal Modem for 1400LT/FD/HD	254	Upgrade.34
25-3525	2400 Bd Internal Modem for 1500/2810/3810	280	Upgrade.39
25-3538	2400 Baud Internal Modem for 1100FD	255	Upgrade.33
25-3555	2400 Bd Internal Modem for 2800HD	279	Upgrade.39

(continued on next page)

TANDY COMPUTER PRODUCTS

UPGRADE BOARDS SORTED BY CATALOG NUMBER
(cont.)

Catalog Number	Description	Figure #	Text
25-4025	Dual Serial/Parallel Board	286	Upgrade.39
25-4025A	Dual Serial/Parallel Board Rev. A	287	Upgrade.40
25-4027	0K Memory Exp. Board for Tandy 3000NL	199/200	Upgrade.30
25-4030	Tandy 3000 2 MEG Memory Board	103	Upgrade.7
25-4031	Multi-Terminal Board for the Tandy 3000	117	Upgrade.17
25-4034	Serial/Parallel Board Rev. A/B/C	102/115	Upgrade.17
25-4037	Enhanced Graphics Adapter	149	Upgrade.13
25-4038	Enhanced Keyboard	129	Upgrade.22
25-4039	Dual Port Serial Board	130	Upgrade.23
25-4043	VGA Adapter Board	191	Upgrade.13
25-4060	Floppy/Hard Drive WD1002-WA2 Controller	95	Upgrade.19
25-4060	Floppy/Hard Drive WD1003-WA3 Controller	124	Upgrade.19
25-4930	Tandy 4000SX Memory Upgrade Board	260	Upgrade.31
25-5029/30	32 Bit Memory Board for Tandy 4000/LX	202	Upgrade.31
25-6030	0K Memory Expansion Adapter for 5000MC	201	Upgrade.31
26-1220	Vianet for Tandy 2000	72	Upgrade.16
26-1221	Vianet for Tandy 1K/3K/4K Series	71/114	Upgrade.16
26-2829	Serial/Parallel Converter	252	Upgrade.45
26-4104	Graphics Board	29	Upgrade.2
26-4105	Visicalc 64K Memory Board	12	Upgrade.2
26-5127	Tandy 2000 Hard Drive Controller Board	60	Upgrade.5
26-5140	Tandy 2000 Monochrome/Color Board	61/62	Upgrade.5
26-5144	Tandy 2000 Digi-Mouse/Clock Board	65	Upgrade.6
26-5161	Tandy 2000 External RAM Board	63/64	Upgrade.5
26-5164	Tandy 2000 Serial Expansion Board	92	Upgrade.15
26-5435	Tandy Etherlink I Original Style	145	Upgrade.24
26-5435	Tandy Etherlink I Late Style	249	Upgrade.25
26-5501	Tandy Etherlink II	210	Upgrade.26
26-5505	Tandy Ethernet	248	Upgrade.36
26-5505A/B	Tandy Ethernet	285	Upgrade.38
26-5506	Tandy Ethernet PLUS Adapter	282	Upgrade.37
26-5540	Tandy Token Ring	250	Upgrade.36
26-5601/2	Tandylink/PLUS	198	Upgrade.27
26-6013	Multi-Terminal Board for 68000 Computer	31	Upgrade.2
26-6501	Arcnet Board	28	Upgrade.2
26-6503	144K RAM Board	13/14	Upgrade.2
26-6505	Tandy Arcnet	251	Upgrade.34
90-2185/6	ARNET Smartport 4/8 Boards	196/197	Upgrade.28
90-2403	ARNET Smartport 16 Port Board	290	Upgrade.42
90-2453	ARNET Multiport 4 Port Board	288	Upgrade.43
90-2458	ARNET Octaport 8 Port Board	289	Upgrade.44

```
*****  
*                                                                 *  
*                                                                 *  
*           M O D E L   I I           *  
*                                                                 *  
*                                                                 *  
*****
```

TANDY COMPUTER PRODUCTS

NOTES:

The recommended order for boards to be installed into the Model II card cage starting at the side nearest the power supply is:

Z-80 CPU board -- REQUIRED
 FDC board -- REQUIRED
 ARCNET board (if installed)
 Hard Disk interface board (if installed)
 Disk Cartridge interface board (if installed)
 Multi-terminal board (if installed)
 Z-80 memory board (s)
 Kb/video board (with the graphics board next to it if it is installed)
 68000 CPU and memory board(s) (if installed)

The Z-80 CPU board should be installed in the first slot (nearest the power supply). The other boards should be installed with no empty slots between them so that the interrupt system will work properly. The only exceptions are the 68000 boards, this is because they do not use Z-80 interrupts. To make installation easier the 68000 boards can be installed into the slots furthest from the Z-80 CPU but make sure that the foil side of the board does not short out against the side of the card cage.

When more than 5 Z-80 boards are installed into Model II the power supply will have to be upgraded to an AXX-6008 or an AXX-6009 type, and a new 5 volt supply wire must be routed to the mother board (AW-2841). With the AXX-6008 power supply, it will be necessary to adjust the power supply output voltage every time the number of boards is changed. Refer to Technical Bulletin II:29 for the AXX-6008 power supply adjustment procedures. If any 68000 boards are used a AXX-6009 power supply must be installed.

Following is a list of all the jumpers for the four basic boards in the Model II. These jumpers may change with new boards and modifications.

CPU Board Rev. A/B/C (figure 1):

Since the pins are labeled differently on all revisions of the CPU board, we are going to use the labels on the Rev. D board. For Rev. A through C and those with no Rev. letter, the position refers to the same place on a Rev. D board.

A-B Found on Revision C boards only
 E0-E1 Generates waits only on an M1 cycle, install if missing
 E3-E4 Generates waits only when ROM is addressed, install if missing
 E14-E15 Connects a clock from the CTC to channel B of the SIO
 E11-E12 Connects a CTC clock to the X-mit section of serial channel A
 E7-E8 Connects a CTC clock to the receive section of channel A

Note the last two jumpers will change with the installation of BiSync. Refer to Technical Bulletin II:17.

CPU board Rev. D (figure 2):

E0-E1 Generates waits only on an M1 cycle, install if missing
E3-E4 Generates waits only if ROM is addressed, install if missing
E14-E15 Connects a clock from the CTC to channel B of the SIO
E11-E12 Connects a clock from the CTC to the X-mit section of chan A
E7-E8 Connects a clock from the CTC to the REC section of chan A

Note again the last two will change with the installation of BiSync. Also, Rev. D boards already have the DMA and Interrupt mods (Technical Bulletin II:26) included as part of the PCB layout. These are the mods that are done for hard disks, graphics boards, and BiSync.

Keyboard/video board (early style figure 3):

1-2 This generates a 30 hz RTC signal (very early board-few made)
On most boards these pins are labeled 14-16 and some versions will need a wire wrap jumper while others can use a push on jumper.

The other jumper connected to pin 21 has to be adjusted for each board and will vary from board to board.

Keyboard/video board (late style labeled LEIMV-1 1082 figure 4):

14-15 This generates a 30 hz RTC signal

The other jumper connected to pin 21 has to be adjusted for each board and will vary from board to board.

Keyboard/Video Board (figure 5):

E1-E2 For Model II type operation
E5-E6 For Model II type operation
14-15 This generates a 30 hz RTC signal

The other jumper connected to pin 21 has to be adjusted for each board and will vary from board to board.

NOTE: This board is normally found in the Model 12 and 16B but may also be found in later Model IIs.

FDC board (early style all Rev's. Figure 6):

3-4 Enables precomp at track >43
6-7 Selects 250 ns precomp
A-B Divides 4 MHZ CPU clock by 2 for 1791 FDC chip

TANDY COMPUTER PRODUCTS

FDC Board (late style with one internal drive - figure 7):

- L-M Selects a positive XFERRQ (Without a Disk Cartridge Installed)
- M-N Inverts XFERRQ (With a Disk Cartridge Installed)
- P-Q Divides 4 MHZ CPU clock by 2 for 1791 FDC chip
- B-C Selects 8" drive ready signal
- T-U Drive 0 is the only internal drive
- J-K FDC board will use ports E0 through EF
- Y-X Enables head load delay

Unlabeled boards do not have a W-X-Y jumper, Rev. A and later do

First 32k memory board (figure 9):

- 1-2 Pulls up an input to U27 that was floating, install if missing
- 5-6 Pulls up an input to U9 that was floating, install if missing
- 16-17 Selects the first 16k of the base page
- 15-18 Selects the second 16k of the base page

Second 32k memory board (figure 10):

- 1-2 Pulls up an input to U27 that was floating, install if missing
- 5-6 Pulls up an input to U9 that was floating, install if missing
- 26-27 Enables the next jumpers on page 1 of the memory map
- 9-11 Selects the first 16k of the page set by above (page 1)
- 10-12 Selects the second 16k of the page set by above (page 1)

First 64k memory board (figure 11):

- 1-2 Pulls up an input to U27 that was floating, install if missing
- 5-6 Pulls up an input to U9 that was floating, install if missing
- 16-17 Selects the first 16k of the base page
- 15-18 Selects the second 16k of the base page
- 26-27 Enables the next jumpers on page 1 of the memory map
- 9-13 Selects the first 16k of the page set by above (page 1)
- 10-14 Selects the second 16k of the page set by above (page 1)

Note: For jumpering a second 64K memory board refer to Upgrade Board.2 (see Visicalc Memory Board 26-4105).

```
*****  
*                                                                 *  
*                                                                 *  
*           M O D E L   I I I           *  
*                                                                 *  
*                                                                 *  
*****
```

4K Model III (figure 85):

GG-FF Selects 4K RAM's
U-T Selects 4K RAM's
B-C Selects 60Hz video sync
D-E Selects timing of vertical sync
H-J Selects timing of vertical sync
K-L Selects timing of vertical sync
V-W Selects timing of horizontal sync
BB-CC Selects timing of horizontal sync

16K/32K/48K Model III (figure 86):

EE-FF Selects 16K RAM's
S-T Selects 16K RAM's
B-C Selects 60Hz video sync
D-E Selects timing of vertical sync
H-J Selects timing of vertical sync
K-L Selects timing of vertical sync
V-W Selects timing of horizontal sync
BB-CC Selects timing of horizontal sync

Early Version FDC board (figure 87):

A-B Selects 1 MHz clock
E-G Selects programmed precomp
H-J Selects read data from one-shot
L-M Selects write data from one-shot

```
*****  
*                                           *  
*                                           *  
*           M O D E L   4                   *  
*                                           *  
*                                           *  
*****
```

TANDY COMPUTER PRODUCTS

16K Model 4, standard PCB (figure 88):

16K RAM's in locations U77-U84

E1-E2 Connects +12v to RAM's pin 8

E5-E6 Connects +5v to RAM's pin 9

E12-E13 Connects -5v to RAM's pin 1

E14-E15 Disables graphic board

Note: E14-E15 is removed when Hi-Res board is installed.

4 pin Dip Shunt at U72:	1	--	--	20
	2	--	--	19
	3	--	--	18
	4	--	--	17
	5	--	--	16
	6	-----		15
	7	-----		14
	8	-----		13
	9	-----		12
	10	--	--	11

64K Model 4, standard PCB (figure 89):

64K RAM's in locations U77-U84

E2-E3 Connects +5v to RAM's pin 8

E4-E5 Connects 'A7' to RAM's pin 9

E7-E8 Connects GND to U59 pin 11 (PAL)

E11-E12 Connects +5v to RAM's pin 1

E14-E15 Disables graphic board

Note: E14-E15 is removed when Hi-Res board is installed.

4 pin Dip Shunt at U72:	1	--	--	20
	2	--	--	19
	3	--	--	18
	4	--	--	17
	5	--	--	16
	6	-----		15
	7	-----		14
	8	-----		13
	9	-----		12
	10	--	--	11

128K Model 4, standard PCB (figure 89):

64K RAM's in locations U77-U84

64K RAM's in locations U85-U92

E2-E3 Connects +5v to RAM's pin 8

E4-E5 Connects 'A7' to RAM's pin 9

E7-E8 Connects GND to U59 pin 11 (PAL)

E11-E12 Connects +5v to RAM's pin 1

E14-E15 Disables graphic board

Note: E14-E15 is removed when Hi-Res board is installed.

128K upgrade PAL installed at U72

TANDY COMPUTER PRODUCTS

64K Model 4, gate array PCB (figure 90):

JP1 Connects +5v to RAM's pin 1
JP4 Connects +5v to RAM's pin 8
JP6 Connects address line to RAM's
JP8 Connects 'All' to ROM B/C (U4)
64K Selects 16K (or larger) RAM chips
JP12 Selects 'CHRADD' from video array (U17)
JP13 Selects 'DOT*' for video data enable
J12 pin 16 to J12 pin 18 - Disables graphic board

Note: This jumper is removed when Hi-Res board is installed.

Jumper wire from U5 pin 16 to ground - selects 64K RAM size

The PAL that comes with the memory upgrade kit is not needed or used with the gate array PCB.

128K Model 4, gate array PCB (figure 90):

JP1 Connects +5v to RAM's pin 1
JP4 Connects +5v to RAM's pin 8
JP6 Connects address line to RAM's
JP8 Connects 'All' to ROM B/C (U4)
64K Selects 16K (or larger) RAM chips
JP12 Selects 'CHRADD' from video array (U17)
JP13 Selects 'DOT*' for video data enable
J12 pin 16 to J12 pin 18 - Disables graphic board

Note: This jumper is removed when Hi-Res board is installed.

Jumper wire from U5 pin 16 to U33 pin 16 - selects 128K RAM size

NOTE: The PAL that comes with the memory upgrade kit is not needed or used with the gate array PCB. When doing the 128K upgrade to a gate array logic board, locate the jumper wire going from U5 pin 16 to ground. Remove the ground side of this jumper, and attach it to pin 16 of U33. Then install the 64K RAM ICs in positions U67 to U74. Refer to Technical Bulletin 4:21 for further details.

This page intentionally left blank.

```
*****  
*                                                                 *  
*                                                                 *  
*           M O D E L   4 D           *  
*                                                                 *  
*                                                                 *  
*****
```

TANDY COMPUTER PRODUCTS

NOTES:

The Model 4D main logic board is electrically identical to the Model 4's gate array logic board. There are however minor physical layout differences. The only change involving the jumpers is the location and function of JP13.

On the Model 4/4D gate array logic board (Rev. B or earlier) with 64K, there is a jumper wire connecting the ENPAGE signal at pin 16 of U5 to ground. In order to select 128K of RAM on this board, this jumper must be removed from ground and attached to pin 16 of U33.

On the Model 4D logic board (Rev. C), 64K or 128K RAM size is selected by JP13 which is now located between U33 and U34 and there isn't a jumper connecting pin 16 of U5 to ground.

64K Model 4D (figure 91):

JP1 Connects +5v to RAM's pin 1
JP4 Connects +5v to RAM's pin 8
JP6 Connects address line to RAM's
JP8 Connects 'All' to ROM B/C (U4)
64K Selects 16K (or larger) RAM chips
JP12 Selects 'CHRADD' from video array (U17)
JP13 lower pins Selects 64K RAM size
J12 pin 16 to J12 pin 18 Disables graphic board
 Note: This jumper is removed when Hi-Res board is installed.

128K Model 4D (figure 91):

JP1 Connects +5v to RAM's pin 1
JP4 Connects +5v to RAM's pin 8
JP6 Connects address line to RAM's
JP8 Connects 'All' to ROM B/C (U4)
64K Selects 16K (or larger) RAM chips
JP12 Selects 'CHRADD' from video array (U17)
JP13 upper pins Selects 128K RAM size
J12 pin 16 to J12 pin 18 Disables graphic board
 Note: This jumper is removed when Hi-Res board is installed.

```
*****  
*                                           *  
*                                           *  
*           M O D E L   4 P           *  
*                                           *  
*                                           *  
*****
```

NOTES:

There are two types of Model 4P main logic boards. The standard and gate array boards are electrically the same and have the same capabilities of performance. The gate array logic board takes advantage of chip array technology replacing many discrete components.

RAM Specification:

Organization	Access Time
64K X 1	200nsec

Model 4P Standard (figure 155):

E1-E2	Provides 1.2672MHZ reference input to the PLL circuit (Standard)
E4-E5	On Graphics board not installed (Standard) Off Enables Graphics board when installed
E6-E7	Uses DCLK as qualifier for VOUT signal
E7-E8	Uses DOT* as qualifier for VOUT signal (Standard)
E9-E10	Off (Standard) Used for PLL adjustment as outlined in Technical Bulletin 4P:2
E11-E12	128K RAM installed
E12-E13	64K RAM installed (Standard)
E14-E15	Enables use of DLYGRAPHIC* signal (Standard)

Model 4P Gate Array (figure 156):

E1-E2	128K RAM installed
E2-E3	64K RAM installed (Standard)
E4-E5	On Graphics board not installed (Standard) Off Enables Graphics board when installed
E6-E7	Uses DCLK as qualifier for VOUT signal
E7-E8	Uses DOT* as qualifier for VOUT signal (Standard) Reference Technical Bulletin 4P:14 when Graphics board is installed.
E14-E15	Enables use of DLYCHAR signal (Standard)

```
*****  
*                                                                 *  
*                                                                 *  
*           M O D E L   1 2           *  
*                                                                 *  
*                                                                 *  
*****
```

TANDY COMPUTER PRODUCTS

NOTES:

The recommended order for boards to be installed into the Model 12 card cage starting at the bottom is:

ARCNET interface board (if installed)
Hard Disk interface board (if installed)
Multi-terminal board (if installed)
Disk Cartridge interface board (if installed)
Z-80 memory board(s) (if installed)
Kb/video board (with the graphics board next to it if it is installed)
68000 CPU and memory board(s) (if installed CPU board on top)

The boards should be installed with no empty slots between them so that the interrupt system will work properly. The only exception are the 68000 boards. This is because they do not use Z-80 interrupts. To make installation easier the 68000 boards can be installed into the slots at the top of the card cage.

The Model 12 has an extra 16K of RAM installed at pages 14 & 15 of the memory map. You should note this when servicing or exchanging the main logic board. A Model 16B/6000 main logic board should not have this extra 16K of memory on it. Wire jumper E38-E39 qualifies this extra memory and should be present when there is an extra 16K of RAM installed and removed when there is not an extra 16K of RAM.

Because of this, the extra 16K RAM board used with ARCNET should not be installed in a Model 12. Also, the RAM on the Hard Disk interface board should be moved to another page of the memory map to avoid a memory map conflict with the Model 12 main logic board 16K RAM. The position labeled AG-AL (pages 8 & 9) is recommended.

Following is a list of all the jumpers for the main logic board and the Video/Keyboard used in the Model 12. These jumpers may change with new boards and modifications.

Model 12 Main logic board (figure 15):

E1-E2 Inserts 1 wait state on every M1 cycle
E4-E5 Connects the 8 megahertz oscillator to the divider logic
E7-E8 Connects SIO channel B to the internal CTC clock
E15-E16 Sets up U63-U70 for using 16K RAM chips
E18-E19 Selects a 2K boot ROM
E24-E25 No delay on head load
E27-E28 FDC gets a READY signal from the disk drive
E31-E49 FDC jumpered for normal operation
E42-E43 -5vdc to pin 1 of U63-U70
E44-E45 +12vdc to pin 8 of U63-U70
E46-E47 +5vdc to pin 9 of U63-U70
E38-E39 Maps U63-U70 on pages 14 and 15 of the memory map
E51-E52 Sets up U63-U70 for using 16K RAM chips
E53-E54 Connects SIO channel A receive to the internal CTC clock
E10-E11 Connects SIO channel A transmit to the internal CTC clock
Note the last two jumpers will change with the installation of BiSync.

Model 12 Keyboard/video board (figure 5):

E1-E2 For Model II type operation

E5-E6 For Model II type operation

14-15 This generates a 30 hz RTC signal

The other jumper connected to pin 21 has to be adjusted for each board and will vary from board to board.

Model 12 Video PCB

The Motorola version of this board is the same as that for the Model 16, except for one cut and one jumper difference. Pin 2 is isolated from the rest of the circuit board by a cut. Pin 2 should be connected by a jumper to pin 5. This modification allows the video signal from the video/keyboard interface to be routed through the video driver board on its way to the brightness control.

This page intentionally left blank.

```
*****  
*                                                                 *  
*                                                                 *  
*           M O D E L   1 6           *  
*                                                                 *  
*                                                                 *  
*****
```

TANDY COMPUTER PRODUCTS

NOTES:

The recommended order for boards to be installed into the Model 16 card cage starting at the side nearest the power supply is:

Z-80 CPU board -- REQUIRED
FDC board -- REQUIRED
ARCNET board (if installed)
Hard Disk interface board (if installed)
Disk Cartridge interface board (if installed)
Multi-terminal board (if installed)
Z-80 memory board(s)
Kb/video board (with the graphics board next to it if it is installed)
68000 CPU and memory board(s)

The Z-80 CPU board should be installed in the first slot (nearest the power supply). The other boards should be installed with no empty slots between them so that the interrupt system will work properly. The only exceptions are the 68000 boards, this is because they do not use Z-80 interrupts. To make installation easier the 68000 boards can be installed into the slots furthest from the Z-80 CPU but make sure that the foil side of the board does not short out against the side of the card cage.

The four basic Z-80 based boards of the Model 16 are functionally the same as the 4 boards of the Model II. For testing purposes the Model II boards can be used to substitute for their counter parts in the Model 16. An exception here is the Model 16 FDC board jumpers S-T and F-H, which deal with the number of internal floppy drives. Refer to the text for correct setting when using a Model II FDC board in a Model 16.

NOTE: These boards are not FCC approved (except for the REV. B RAM board) and cannot be left in a Model 16 when it is returned to the customer.

While TRSDOS 2.0 and the diagnostic DOS do not need to have the 68000 CPU board or RAM board installed to be booted, the TRSDOS 4.x operating systems require that either a hard disk interface board, a 68000 board set or a 16k memory board be installed. If the 68000 boards are suspected of causing a problem they can be removed and the computer then tested with the diagnostic DOS to see if they are the cause. Also TRSDOS 1.2a will not work properly with the Model 16 at this time, due to the thinline drives.

Following is a list of all the jumpers for the six basic types of boards in the Model 16. These jumpers may change with new boards and modifications.

CPU Board Rev. D (figure 2):

E0-E1 Generates waits only on an M1 cycle, install if missing
E3-E4 Generates waits only if ROM is addressed, install if missing
E14-E15 Connects a clock from the CTC to channel B of the SIO
E11-E12 Connects a clock from the CTC to the X-mit section of chan A
E7-E8 Connects a clock from the CTC to the REC section of chan A

Note the last two will change with the installation of BiSync (Technical Bulletin II:17). Also, Rev. D boards already have the DMA and interrupt mods (Technical Bulletin II:26) included as part of the PCB layout. These are the mods that are done for hard disks, graphics boards, and BiSync.

Keyboard/Video Board (late style labeled LEIMV-1 1082 figure 4):

14-15 This generates a 30 hz RTC signal
The other jumper connected to pin 21 has to be adjusted for each board and will vary from board to board.

Keyboard/Video Board (figure 5):

E1-E2 For Model II type operation
E5-E6 For Model II type operation
14-15 This generates a 30 hz RTC signal
The other jumper connected to pin 21 has to be adjusted for each board and will vary from board to board.

NOTE: This board is normally found in the Model 12 and 16B but may also be found in later Model 16s.

FDC Board (late style with two internal drives. Figure 8):

L-M Selects a positive XFERRQ (Without a Disk Cartridge installed)
M-N Inverts XFERRQ (With a Disk Cartridge installed)
P-Q Divides 4 MHZ CPU clock by 2 for 1791 FDC chip
B-C Selects 8" drive ready signal
S-T Allows more than 1 internal drive
F-H Sets two internal drives
J-K FDC board will use ports E0 through EF
W-X Disables head load delay
Unlabeled boards do not have a W-X-Y jumper, Rev. A and later do

First 64K Memory Board (figure 11):

1-2 Pulls up an input to U27 that was floating, install if missing
5-6 Pulls up an input to U9 that was floating, install if missing
16-17 Selects the first 16K of the base page
15-18 Selects the second 16K of the base page
26-27 Enables the next jumpers on page 1 of the memory map
9-13 Selects the first 16K of the page set by above (page 1)
10-14 Selects the second 16K of the page set by above (page 1)

TANDY COMPUTER PRODUCTS

68000 CPU Board (figure 16):

E3-E10 Sets the interrupt acknowledge level (level should match E19)
E16-E19 Sets the interrupt level at 5
E43-E44 Causes the refresh circuit to output a pulse every 31.5 us
(Labeled E29-E30 on some boards)
E47-E48 Selects a 6 MHZ clock for the 68000
(Labeled E33-E34 on some boards)
Pin 11 of U34 pulled out of the socket & tied to ground

Reduced Size 68000 Board (figure 17):

E1-E2 Causes the refresh circuit to output a pulse every 31.5 us
E4-E7 Selects a 6 MHZ clock for the 68000

68000 first memory board (either 128K or 256K, figure 18):

E13-E14 Connects A14 directly to the RAM
E15-E16 Connects A16 directly to the RAM
E17-E18 Connects A15 directly to the RAM
E11-E12 Supplies A17 inverted to 1/2 the RAM
Position 2 of S1 on. This maps the board at 000000 to 03FFFF

68000 second memory board (either 384K or 512K) (figure 18):

Same as the first memory board except both 2 & 3 should be in the on position on S1 to map the RAM on this board between 040000 to 07FFFF

68000 third memory board (either 640K or 768K) (figure 18):

Same as the first memory board except both 2 & 5 should be in the on position on S1 to map the RAM on this board between 080000 to 0BFFFF

68000 fourth memory board (either 896K or 1024K) (figure 18):

Same as the first memory board except 2, 3, and 5 should be in the on position on S1 to map the RAM on this board between 0C0000 to 0FFFFF

TANDY COMPUTER PRODUCTS

```
*****  
*                                                                 *  
*                                                                 *  
*           M O D E L   1 6 B           *  
*                                                                 *  
*                                                                 *  
*****
```

NOTES:

The recommended order for boards to be installed into the Model 16B card cage starting at the bottom is:

ARCNET interface board (if installed)
Hard disk interface board (if installed)
Multiterminal board (if installed)
Kb/video board (with the graphics board next to it if it is installed)
2-80 memory board(s) (if installed)
68000 CPU and memory board(s) (if installed CPU board on top)

The boards should be installed with no empty slots between them so that the interrupt system will work properly. The only exceptions are the 68000 boards, this is because they do not use 2-80 interrupts. To make installation easier the 68000 boards can be installed into the slots at the top of the card cage.

The Model 16B should not have the extra 16k RAM as the Model 12 has. You should note this when servicing or exchanging the main logic board. Wire jumper E38-E39 qualifies this extra memory and should be present when there is an extra 16K of RAM installed (as in the Model 12) and removed when there is not an extra 16K of RAM (as in the Model 16B/6000).

Because of this the RAM on the hard disk interface board should be mapped at pages 14 and 15 like the Model II and 16. The position labeled AK-AP is the proper location.

While TRSDOS 2.0 and the diagnostic DOS do not need to have the 68000 CPU board or RAM board installed to be booted, the TRSDOS 4.x operating systems require that either a hard disk interface board, a 68000 board set or a 16k memory board be installed. If the 68000 boards are suspected of causing a problem they can be removed and the computer then tested with the diagnostic DOS to see if they are the cause. Also TRSDOS 1.2a will not work properly with the Model 16B at this time, due to the thinline drives.

Following is a list of all the jumpers for the main logic and the Video/Keyboard PCB's in the Model 16B. These jumpers may change with new boards and modifications.

Model 16B Main logic board (figure 39):

E1-E2 Inserts 1 wait state on every M1 cycle
E4-E5 Connects the 8 megahertz oscillator to the divider logic
E7-E8 Connects SIO channel B to the internal CTC clock
E15-E16 Sets up U63-U70 for using 16K RAM chips
E18-E19 Selects a 2K boot ROM
E24-E25 No delay on head load
E27-E28 FDC gets a READY signal from the disk drive
E31-E49 FDC jumpered for normal operation
E40-E41 On If one internal floppy drive installed
Off If two internal floppy drives installed
E42-E43 -5vdc to pin 1 of U63-U70
E44-E45 +12vdc to pin 8 of U63-U70
E46-E47 +5vdc to pin 9 of U63-U70
E51-E52 Sets up U63-U70 for using 16K RAM chips
E53-E54 Connects SIO channel A receive to the internal CTC clock
E10-E11 Connects SIO channel A transmit to the internal CTC clock

Note the last two jumpers will change with the installation of BiSync.

Model 16B Keyboard/video board (figure 5):

E1-E2 For Model II type operation
E5-E6 For Model II type operation
14-15 This generates a 30 hz RTC signal
The other jumper connected to pin 21 has to be adjusted for each board and will vary from board to board.

Model 16B Video PCB

The Motorola version of this board is the same as that for the Model 16, except for one cut and one jumper difference. Pin 2 is isolated from the rest of the circuit board by a cut. Pin 2 should be connected by a jumper to pin 5. This modification allows the video signal from the video/keyboard interface to be routed through the video driver board on its way to the brightness control.

This page intentionally left blank.

TANDY COMPUTER PRODUCTS

```
*****  
*                                                                 *  
*                                                                 *  
*           M O D E L   6 0 0 0           *  
*                                                                 *  
*                                                                 *  
*****
```

NOTES:

The recommended order for boards to be installed into the Tandy 6000 card cage, starting at the bottom, is:

ARCNET board (if installed)
Hard disk interface board (if installed)
Multiterminal board (if installed)
Disk Cartridge interface board (if installed)
Keyboard/video interface (with the graphics board next to it if installed)
2-80 memory board(s) (if installed)
68000 CPU board
68000 Memory board(s)

The boards should be installed with no empty slots between them so that the interrupt system will work properly. The only exceptions are the 68000 boards, this is because they do not use 2-80 interrupts. To make installation easier the 68000 boards can be installed into the slots at the top of the card cage.

The Model 6000 should not have the extra 16k RAM as the Model 12 has. You should note this when servicing or exchanging the main logic board. Wire jumper E38-E39 qualifies this extra memory and should be present when there is an extra 16K of RAM installed (as in the Model 12) and removed when there is not an extra 16K of RAM (as in the Model 16B/6000).

Because of this the RAM on the hard disk interface board should be mapped at pages 14 and 15 like the Model II and 16. The position labeled AK-AP is the proper location.

Following is a list of all the jumpers for the main logic, Video/Keyboard and 68000 boards in the Tandy 6000. These jumpers may change with new boards and modifications.

TANDY COMPUTER PRODUCTS

Tandy 6000 Main logic board (identical to the Model 16B, figure 39):

E1-E2 Inserts 1 wait state on every M1 cycle
E4-E5 Connects the 8 megahertz oscillator to the divider logic
E7-E8 Connects SIO channel B to the internal CTC clock
E15-E16 Sets up U63-U70 for using 16k RAM chips
E18-E19 Selects a 2k boot ROM
E24-E25 No delay on head load
E27-E28 FDC gets a READY signal from the disk drive
E31-E49 FDC jumpered for normal operation
E40-E41 On If one internal floppy drive installed
Off If two internal floppy drives installed
E42-E43 -5vdc to pin 1 of U63-U70
E44-E45 +12vdc to pin 8 of U63-U70
E46-E47 +5vdc to pin 9 of U63-U70
E51-E52 Sets up U63-U70 for using 16k RAM chips
E53-E54 Connects SIO channel A receive to the internal CTC clock
E10-E11 Connects SIO channel A transmit to the internal CTC clock

Note the last two jumpers will change with the installation of BiSync.

Tandy 6000 Key/video board (identical to the Model 16B, figure 5):

E1-E2 For Model II type operation
E5-E6 For Model II type operation
14-15 This generates a 30 Hz RTC signal
The other jumper connected to pin 21 has to be adjusted for each board and will vary from board to board.

8 MHz 68000 CPU board (figure 66):

E1-E2 Selects 15.5 usec refresh timing
E6-E7 Sets "PCLOCK" to 8 MHz

512K/1MEG 68000 RAM board with 512K (figure 67):

E1-E2 Select 512K RAM size
E5-E6 Along with S1 and E1-E2 maps RAM at address 000000 to 07FFFF
E7-E8 Configures A19 to select RAS multiplexor
E12-E14 Configures for 150 ns RAM (Normal configuration)
E13-E14 Configures for 200 ns RAM
S1 position 2 should be on all others should be off

512K/1MEG 68000 RAM board with 1MEG (figure 68):

E2-E3 Select 1MEG RAM size
E5-E6 Along with S1 and E2-E3 maps RAM at address 000000 to 0FFFFFF
E7-E8 Configures A19 to select RAS multiplexor
E12-E14 Configures for 150 ns RAM (Normal configuration)
E13-E14 Configures for 200 ns RAM
S1 position 2 should be on all others should be off

TANDY COMPUTER PRODUCTS

8 MHz 68000 CPU board used with MMU upgrade (figure 66):

This 68000 CPU board must be used with 1 MEG memory boards only.

E1-E2 Selects 15.5 μ sec refresh timing

E6-E7 Sets "PCLOCK" to 8 MHz

6000 MMU (figure 157): No jumpers are present on this board. The memory management unit consists of satellite circuit board that plugs into the 68000 CPU socket. This MMU kit consists of a modified 68000 CPU board with the satellite MMU board installed. To complete this upgrade, the customer must provide a working 8 MHz 68000 CPU board (AX-9006) to exchange for the modified 68000 MMU CPU board. Refer to Technical Bulletin 6000:18 for installation instructions.

512K/1MEG 68000 RAM board with 512K (figure 158):

E1-E2 Select 512K RAM size

E5-E6 Along with S1 and E1-E2 maps RAM at address 000000h to 07FFFFh (board 1) or 100000h to 17FFFFh (board 2 -- used with MMU upgrade)

E7-E8 Configures A19 to select RAS multiplexer

E12-E14 Configures for 150 ns RAM (normal configuration)

E13-E14 Configures for 200 ns RAM

Board 1: S1, position 2 on, all others off.

Board 2: S1, positions 2, 7 on, all others off. *

512K/1MEG 68000 RAM board with 1 MEG (figure 159):

E2-E3 Select 1 MEG RAM size

E5-E6 Along with S1 and E2-E3 maps RAM at address 000000h to 0FFFFFFh (board 1) or 100000h to 1FFFFFFh (board 2 -- used with MMU upgrade)

E7-E8 Configures A19 to select RAS multiplexer

E12-E14 Configures for 150 ns RAM (normal configuration)

E13-E14 Configures for 200 ns RAM

Board 1: S1, position 2 on, all others off.

Board 2: S1, positions 2, 7 on, all others off. *

* Switch settings for use with the second 1 MEG board, only with the MMU kit.

```
*****  
*                                           *  
*                                           *  
*           T A N D Y   1 0 0 0           *  
*                                           *  
*                                           *  
*****
```

TANDY COMPUTER PRODUCTS

Tandy 1000 Main logic board (figure 42):

E5-E6 Connects clock to video logic
E8-E9 Connects 8 MHZ clock to FDC clock divider
E21-E22 Selects active drive ready signal constantly

Tandy 1000A Main logic board (figure 83):

E1-E2 Connects clock crystal to circuit
E3-E4 Selects continuous floppy drive ready (this is a wire jumper)
E6-E7 Connects printer select to parallel port
E8-E9 Indicates there is NO coprocessor installed
(Remove E8-E9 when installing coprocessor chip)

NOTE: To enable use of some IBM software and/or our IBM compatible printers E6-E7 should be removed. This is equivalent to Technical Bulletin 1000:05.

TEAC FD-54B 5 1/4" Floppy drive logic board (figure 43):

IU Selects active In-Use signal
DSx Drive Select, x = 0-3
Termination (RA1) will be on all drives.

Internal 10 MEG drive logic board as in Tandy 1000HD (figure 76):

W14 Disables backlash
DSx Drive select (W12 = drive 1, W9 = drive 4)
Last drive on cable should have terminating resistor at U19

NOTE: DS2 (W11) is used to configure for drive C.

Tandy 1000HD WD1002S-WX2 hard drive controller board (figure 77):

W1 pins 1-2 Connects 'DSEL0' (drive select) to bus
W2 pins 1-2 Connects 'RG' (read gate) into circuit
W3 pins 1-2 Connects 'ROMEN' (ROM enable) to ROM
W4 pins 2-3 Connects 'A2' (address line 2) for address select
W6 pins 2-3 Connects 'RWC' (reduced write current) to J1 (drive)
W7 pins 2-3 Selects IRQ2 (standard)
pins 1-2 Selects IRQ5

(continued on next page)

TANDY COMPUTER PRODUCTS

The following are eight (8) sets of jumpers labeled SW1 positions 1-8. Notice that they are numbered from the bottom 1 through 4 and then backwards 8 through 5.

Position 5	ON	Selects address
Position 6	OFF	Selects address
Position 7	OFF	Selects address
Position 8	OFF	Selects address
Position 4	With position 3 selects Drive D type	
Position 3	(See below for drive types)	
Position 2	With position 1 selects Drive C type	
Position 1	(See below for drive types)	

DRIVE C:	1	2	DRIVE D:	3	4
35 MEG	ON	ON	35 MEG	ON	ON
15 MEG	ON	OFF	15 MEG	ON	OFF
10 MEG	OFF	ON	10 MEG	OFF	ON

For 20 MEG hard drive support, use the following table and refer to Technical Bulletin 1000:37 for more information.

DRIVE C:	1	2	DRIVE D:	3	4
35 MEG	ON	ON	35 MEG	ON	ON
20 MEG	ON	OFF	20 MEG	ON	OFF
10 MEG	OFF	ON	10 MEG	OFF	ON

This page intentionally left blank.

TANDY COMPUTER PRODUCTS

```
*****  
*                                                                 *  
*                                                                 *  
*           T A N D Y   1 0 0 0 E X           *  
*                                                                 *  
*                                                                 *  
*****
```

TANDY COMPUTER PRODUCTS

Tandy 1000 EX Main Logic Board Revision A (figure 120):

Tandy 1000 EX Main Logic Board Revision D (figure 284):

Note: The jumpers are the same for both boards.

E1-E2 Connects printer select signal (SEL*) to the printer port
 (Remove E1-E2 to tie SEL* high and enable use of IBM software)

TEAC FD-55BV Floppy Drive Logic Board (figure 107):

DSx Drive Select (DS0 = Drive A, DS1 = Drive B)

Termination (RA1) will be on all drives.

TANDY COMPUTER PRODUCTS

```
*****  
*                                                                 *  
*                                                                 *  
*           T A N D Y   1 0 0 0 H X           *  
*                                                                 *  
*                                                                 *  
*****
```

Notes:

There is a SETUPHX file on the Tandy 1000HX DOS diskette and on the 1000HX diagnostics diskette. This program must be run when performing floppy drive upgrades. This program should also be run when exchanging a board received from parts.

RAM Specifications:

Organization	Access Time
64K X 4	150nsec

Tandy 1000 HX Main Logic Board (figure 135):

E1-E2	Off:	Pulls up Printer Select Line to +5V (Standard)
	On:	Connects Printer Select Line to Printer Port

SONY MP-F63-70D 3 1/2" 720K Floppy Disk Drive (figure 144):

DS0	Drive A	Slide switch positioned all way to rear.
DS1	Drive B	Slide switch positioned second notch from the rear.

Termination is internal to the drive.

TANDY COMPUTER PRODUCTS

```
*****  
*                                     *  
*                                     *  
*   T A N D Y   1 0 0 0 R L / H D   *  
*                                     *  
*                                     *  
*****
```

TANDY COMPUTER PRODUCTS

Introduction:

The 1000RL uses a 10MHz 8086 microprocessor in the new 44-pin PLCC package, a 120-pin DMA/CPU control chip, and a Keyboard/Floppy support chip that supports a PS/2 mouse port. Other features include a slim-line case (3" high x 13 1/2" wide x 15" deep), MS-DOS and the Deskmate Desktop in ROM, speech and sound capabilities, Tandy Graphics Adapter (TGA) and Hercules compatible video, 2 joystick ports, a 9 pin RS-232 serial port, and a DB-25 PC compatible printer port. The standard 1000RL comes equipped with:

- * 10 MHz 8086-1 CPU, selectable at 9.54 MHz or 4.77 MHz.
- * 512K Base RAM in (2) 256K x 4 bit RAMs and (8) 64K x 4 RAMs
- * Expandable to 768K by installing (2) 256K x 4 bit RAMs (100nSec) in sockets U19 and U23)
- * MS-DOS version 3.30.22, Deskmate Desktop version 3.04
- * One 8-bit XT-style expansion slot allowing up to a 9.5 inch long card
- * One RS-232 serial port
- * One parallel printer port on the main logic board (LPT1 at port address 0378 hexadecimal)
- * Speech/sound support with a microphone input and external sound output on a separate sound/serial/joystick satellite board
- * CGA/TGA/MGA/Hercules compatible RGB video port
- * Dual joystick controller
- * An on-board Floppy Disk Controller that can support (2) 720K drives.
- * One 720K 3.5 inch floppy disk drive
- * Enhanced 101-key, PS/2 style keyboard
- * PS/2 compatible mouse port
- * 25-Watt power supply

Notes:

There is a SETUPRL file on the Tandy 1000RL DOS diskette. This program must be run when performing floppy drive upgrades as well as changing other options of the computer. Also, running SETUPRL /A will give you additional setup screens which control options such as video memory size, control of certain chip selects, network options, etc.. Using the /A option with this program should be executed with great care!

One option in setup allows changing the video mode between monochrome and color. This can also be accomplished by depressing the key sequence given below. Each word within the <> refers to a single key, not to the letters of the keys themselves. Executing this key sequence will cause the computer to reboot!

<CTRL><ALT><SHIFT><V>

TANDY COMPUTER PRODUCTS

The 1000RL/HD comes standard with one of two versions of a SmartWatch chip kit. The 25-1033 version SmartWatch operates without a battery and plugs into a 28 pin socket at U28. The 23-162 version SmartWatch contains a DS1215 clock chip at U29 and a crystal at Y4, and requires a battery. The 1000RL has the 28 pin socket for an optional 25-1033 version of the SmartWatch. Due to these differences, the main logic boards are not interchangeable.

Tandy 1000 RL and Main Logic Board 25-1450 (figure 272):

There are two sets of jumpers on the main logic board and one jumper group on the audio interface PCB. An asterisk (*) next to the jumper numbers denote factory default settings. The jumpers are as follows:

- E12-E13 Connects IRQ5 to VSYNC which is used by some software originally designed for the Tandy 1000 or the IBM PC Jr. This jumper may cause your video to roll if some other device is using this interrupt. If this is the case, try to change the interrupt used by the other device or disable the VSYNC interrupt by removing the jumper.
- E13-E14* Connects IRQ5 to the hard drive IRQ line on the IDE port.
- E14-E15 Connects IRQ2 to the hard drive IRQ line on the IDE port.

The following option does not have staking pins, but is silk-screened on the board. This is used for compatibility with some non-Tandy printers:

- E2-E3** Connects SLCTIN* to the printer
- E3-E4* Disconnects SLCTIN* from the printer port (permanently wired on the board)

**NOTE: Installing staking pins and a jumper from E2-E3 will enable the parallel port to be bidirectional for use with external devices designed to connect to a parallel port. Refer to Technical Bulletin 1000:59 for more information.

Early production units (on both the 1000RL and 1000RL/HD) will have an early version of the KMFIT. The early KMFIT (X07900300) will have a decoding PAL XU1, a resistor pack XRP1, and a buffer at XU2. The later version of the KMFIT (X07900300A) will contain these components internally.

Tandy 1000RL Sound/Serial/Joystick (SSJ) board (figure 272):

- E7-E8 Connects a line level audio input device such as a stereo to AUDIOIN
- E6-E7* Connects a microphone input to AUDIOIN

Power Supply:

The 1000RL and RL/HD contain a 25-Watt power supply that connects to the main logic board via the 6-pin connector at J1. This supplies 5 Volts at 3.3 Amps, 12 Volts at 600 mA, and -12 Volts at 110 mA. A fan is not used in the power supply section. The power supply instead is cooled by strategically located vents.

TANDY COMPUTER PRODUCTS

TEAC FD235F-105U 3 1/2 inch 720K Drive Logic Board (figure 215):

D0 Drive select 0.

D1 Drive select 1.

Left pins of RY and DC should be jumped (Connects Ready input to pin 34 of ribbon cable signal. All other jumpers should be off.

Power is derived from ribbon cable (no separate power connector).

Termination is internal to the drive.

ST-325X 20 Meg IDE Hard Drive 25-1047 (figure 292):

The new low power 20 Megabyte Seagate ST-325X drive is used in the RL/HD version of the computer. The ST-325X utilizes the IDE-XT interface. The drive logically formats as 615 tracks, 4 heads, 17 sectors/track, and 512 bytes/sector for a total of 21.4 Megabytes. Technical Bulletin HD:48 is especially applicable with this drive. In addition the drive should not be tilted more than 5 degrees from horizontal or from vertical.

The jumpers are factory set and will not need to be changed for any standard configuration. The factory settings are:

J5 1-2	Reset Active High
J5 3-4	Reset Active Low (*Factory Default)
J5 5-6	Life Test

Upgrade Options:

The RAM may be upgraded in this computer from 512K to 768K by installing 2 256Kx4 100nS DRAMs (catalog #25-1082) in the two empty sockets (labeled U19, U23) provided; no jumpers are required. **A numeric coprocessor (8087) is not supported in the 1000RL.** The 1000RL also has a socket at U28 for the SmartWatch option (catalog #25-1033).

In the 1000RL there is a slot for either a secondary 3.5 inch internal floppy disk drive (catalog #25-1075) or either a 20 MEG hard drive (catalog #25-1047) or a 40 MEG hard drive (catalog #25-1048). These two hard drives are the only ones supported due to power supply limitations. The second 3.5 inch floppy disk drive can be added using the supplied bracket (using the screw holes marked "FD"). For the SmartDrive, the mounting bracket can be rotated to mount the hard drive (using the screw holes marked "HD"). Always use the screws provided for this hard drive, as an incorrect pitch or length can cause irreparable damage to the drive.

NOTE: Only one hard drive and one floppy OR two floppy drives will function in this machine at one time. The computer should not be power cycled rapidly in the 1000RL/HD due to the startup power consumption of the ST-325X hard drive. Damage to the power supply may result.

TANDY COMPUTER PRODUCTS

```
*****  
*                                                                 *  
*                                                                 *  
*   T A N D Y   1 0 0 0 R L X / H D   *  
*                                                                 *  
*                                                                 *  
*****
```

TANDY COMPUTER PRODUCTS**Introduction:**

The Tandy 1000RLX is an 80286 based XT-compatible computer system. The Tandy 1000RLX includes an IDE hard drive port, 1.44 Meg diskette drive, 512K RAM, built in serial, parallel, joystick, keyboard, and a PS/2 compatible mouse port. The 1000RLX also has MS-DOS Version 03.30.23 and the Deskmate Desktop Version 03.04.02 in ROM. The 1000RLX uses a VGA video port that is software compatible with CGA, EGA, VGA, and Hercules Monochrome. In the standard configuration, the 1000RLX comes with:

- * 10/5 Mhz 80L286-10 microprocessor.
- * 512K RAM on main board (80ns).
- * Expansion for an additional 512K RAM (80ns).
- * 101 key PS/2 style keyboard.
- * PS/2 compatible mouse port.
- * Built in VGA compatible video port.
- * 256K of video memory.
- * On board XT IDE hard drive port.
- * On board FDC that can support two floppy drives (1.44 Meg or 720 K).
- * 1.44 Meg internal 3 1/2" floppy drive.
- * One DB-25 parallel port.
- * One DB-9 RS-232 serial port.
- * Two joystick ports.
- * On board real time clock chip.
- * A 10 inch XT compatible expansion slot.
- * MS-DOS and Deskmate Desktop in ROM.
- * Enhanced speech and sound support.

Notes:

There is a SETUPRLX file on the Tandy 1000RL DOS diskette. This program must be run when performing floppy drive upgrades as well as changing other options of the computer. Also, running SETUPRLX/A will give you additional setup screens which control options such as video memory size, control of certain chip selects, network options, etc.. Using the /A option with this program should be executed with great care!

Tandy 1000RLX Main Logic Board 25-1452 (figure 273):

E10-E11	* Dual map video BIOS at F0000-F7FFF and C0000-C7FFF
E11-E12	Dual mapping of video BIOS disabled
E7-E8	Disable onboard VGA port
E8-E9	* Enable onboard VGA port
E2-E3	Video IRQ3 enabled (Jumpered)
	* Video IRQ3 disabled (Not jumpered)
E4-E5	* FDC primary address
E5-E6	FDC secondary address

Tandy 1000RLX SSJ Board (figure 273):

- E7-E8 Connects a line level audio input device such as a stereo to
AUDIOIN
- E6-E7* Connects a microphone input to AUDIOIN

Note: the '*' denotes default settings.

Teac 235HF-106U 1.44 Meg 3 1/2 inch Drive Logic Board (figure 275):

The floppy drive is a Teac FD-235HF-106U 1.44 Meg 3 1/2 inch drive. There are two sets of jumper blocks located at the rear of the floppy drive. The following is a list of the jumpers and their functions:

- FG: Frame ground. This jumper is permanently installed.
- D0: Drive select zero. (default)
- D1: Drive select one.
- HHI: Logic HI sets the drive in high density mode (not used).
- LHI: Logic LOW sets the drive in high density mode (not used).
- OP: High density switch enabled (jumpered).
- HHO: High density output on high (not used).
- D2: Drive select two. Jumper between D2 and center pin.
- D3: Drive select three. Jumper between D3 and center pin.

Seagate ST-351A/X 40 Meg IDE Hard Drive 25-1048 (figure 293):

The Tandy 1000RLX/HD uses a 40 Meg IDE hard drive. This hard drive is a low power Seagate ST-351A/X. A jumper block on the hard drive is labeled J2 and the jumpers are numbered 1 to 18. Jumper pin 1 is located toward the center of the drive. For more information on the function of these jumpers refer to Technical Bulletin HD:61 or see Chapter Hard Drive.60. The default settings for these jumpers are:

- | | |
|----------------------|------------------------|
| JP1 1-2 Not Jumpered | JP6 11-12 Not Jumpered |
| JP2 3-4 Jumpered | JP7 13-14 Not Jumpered |
| JP3 5-6 Not Jumpered | JP8 15-16 Not Jumpered |
| JP4 7-8 Not Jumpered | JP9 17-18 Jumpered |
| JP5 9-10 Jumpered | |

Expansion Options:

The 1000RLX is equipped with 512K RAM soldered onto the main logic board. An additional 512K RAM can be added to the main logic board using four 256K X 4 ZIP memories (KM44C256AZ-8, cat. # 25-1083) at locations U23, U24, U25, and U26.

Note: The 1000RLX/HD comes equipped with the expansion RAM on the main logic board.

Either a low power IDE XT hard drive can be added using the onboard XT IDE port or a second 3 1/2 inch floppy drive can be added. **Due to power supply limitations both devices cannot be installed in the 1000RLX at the same time.** The floppy drive interface can support either 720K 3 1/2 inch or 1.44 Meg 3 1/2 inch floppy drives. The hard drive must be a 25-1047, 20 Meg hard drive or a 25-1048, 40 Meg hard disk drive as these drives are low power consuming.

A single XT compatible expansion slot is provided. The slot can support boards up to 9.5 inches in length which allows for a variety of expansion capabilities.

Expansion ports for adding joysticks and a PS/2 mouse are provided. There are also ports for adding either headphones or amplified speakers and a microphone to enhance the sound capabilities of the 1000RLX.

```
*****  
*                                                                 *  
*                                                                 *  
*           T A N D Y   1 0 0 0 S L           *  
*                                                                 *  
*                                                                 *  
*****
```

TANDY COMPUTER PRODUCTS

Notes:

There is a SETUPSL file on the Tandy 1000SL DOS diskette and on the 1000SL diagnostics diskette. This program must be run when performing floppy drive upgrades. Also, running SETUPSL/A will give you additional setup screens which control options such as video memory size, control of certain chip selects, network options, etc. Using the /A option with this program should be executed with great care!

Tandy 1000SL Main Logic board 25-1401 (figure 203):

E2 - E3 connects IRQ5 to the bus (standard)

E3 - E4 connects IRQ5 to VSYNC

E5 - E6 connects SLCTIN* to the printer

E6 - E7 ties SLCTIN* high (standard = there can either be a jumper here
or not; either way will tie SLCTIN* high)

Satellite Sound Board

E1 - E2 connects line input to AUDIOIN

E2 - E3 connects microphone input to AUDIOIN (standard)

TANDY COMPUTER PRODUCTS

```
*****  
*                                                                 *  
*                                                                 *  
*           T A N D Y   1 0 0 0 S L / 2                       *  
*                                                                 *  
*                                                                 *  
*****
```

Notes:

There is a SETUPSL/2 file on the Tandy 1000SL/2 DOS diskette and on the 1000SL/2 diagnostics diskette. This program must be run when performing floppy drive upgrades. Also, running SETUPSL2/A will give you additional setup screens which control options such as video memory size, control of certain chip selects, network options, etc.. Using the /A option with this program should be executed with great care!

Tandy 1000 SL/2 Main Logic board Revision C 25-1402 (figure 223):

E2 - E3 jumped connects IRQ5 to the Expansion Bus (default)
E3 - E4 jumped connects VSYNC to IRQ5

E5 - E6 jumped connects SLCTIN* to the printer
E6 - E7 jumped ties SLCTIN* hi (default)

Tandy 1000SL/2 Audio Interface board (refer to figure 203 Satellite Sound Board diagram)

E1 - E2 jumped connects a line audio input such as a stereo to AUDIOIN
E2 - E3 jumped connects a microphone input to AUDIOIN (default)

Tandy 1000 SL/2 Main Logic Board Revision D 25-1402 (figure 224):

The Revision D Main Logic Board has the same jumpers as listed above as well as an additional jumper block labeled E901-E902-E903. Refer to Technical Bulletin 1000:49 for further details concerning this jumper setting.

E902-E903	For the following SHARP ROM set only -	SU4 ROM	SU3 ROM
		8079047	8079048
		LH5321R7	LH5321R8

E901-E902 All other ROM sets, SHARP or HITACHI

TANDY COMPUTER PRODUCTS

```
*****  
*                                                                 *  
*                                                                 *  
*           T A N D Y   1 0 0 0 S X           *  
*                                                                 *  
*                                                                 *  
*****
```

RAM Specification:

Organization	Access Time
256K X 1	150nsec
64K X 1	150nsec

Tandy 1000SX Main Logic Board (figure 121):

E1-E2	Selects 384K RAM (standard) (Remove E1-E2 when upgrading to 640K)
E3-E4	Indicates NO coprocessor is installed (standard) (Remove E3-E4 when installing a coprocessor)
E5-E6	Connects printer select signal (SEL*) to the printer port (Remove E5-E6 to tie SEL* high and enable use of IBM software)

Switch S2:

Position 1:	Off	Selects Composite Monochrome Monitor
	On	Selects Color RGB Monitor
Position 2:	Off	Disables on board Interrupt 5 (See note 1)
	On	Enables on board Interrupt 5 (Standard)
Position 3:	Off	Disables on board Interrupt 6
	On	Enables on board Interrupt 6 (Standard)
Position 4:	Off	Disables on board Interrupt 7
	On	Enables on board Interrupt 7 (Standard)

Note:

1. IRQ5 is used by some Hard Drive Controllers

TEAC FD-55BV Floppy Drive Logic Board (figure 107):

DSx Drive Select (DS0 = Drive A, DS1 = Drive B)

Termination (RA1) will be on all drives.

```
*****  
*                                           *  
*                                           *  
*           T A N D Y   1 0 0 0 T L       *  
*                                           *  
*                                           *  
*****
```

TANDY COMPUTER PRODUCTS

Notes:

There is a SETUPTL file on the Tandy 1000TL DOS diskette and on the 1000TL diagnostics diskette. This program must be run when performing floppy drive upgrades. Also, running SETUPTL/A will give you additional setup screens which control options such as video memory size, control of certain chip selects, network options, etc.. Using the /A option with this program should be executed with great care!

Tandy 1000 TL Main Logic Board 25-1601 (figure 204):

- E1 - E2 connects IRQ5 to VSYNC
- E2 - E3 connects IRQ5 to expansion bus (standard)

- E4 - E5 on connects SLCTIN* to printer
off ties SLCTIN* high (standard)

- E6 - E7 connects microphone input to AUDIOIN (standard)
- E7 - E8 connects line input to AUDIOIN

- E9 - E10 present as solder pads on the board but not used or connected to anything.

TANDY COMPUTER PRODUCTS

```
*****  
*                                                                 *  
*                                                                 *  
*           T A N D Y   1 0 0 0 T L / 2           *  
*                                                                 *  
*                                                                 *  
*****
```

TANDY COMPUTER PRODUCTS

Notes:

There is a SETUPTL2 file on the Tandy 1000TL/2 DOS diskette and on the 1000TL/2 diagnostics diskette. This program must be run when performing floppy drive upgrades. Also, running SETUPTL2/A will give you additional setup screens which control options such as video memory size, control of certain chip selects, network options, etc.. Using the /A option with this program should be executed with great care!

Tandy 1000TL/2 Main Logic Board 25-1602 (figure 225):

E6 - E7 open connects IRQ5 to the Expansion Bus

E6 - E7 jumped connects VSYNC to IRQ5 (default)

E7 - E8 jumped connects IDE IRQ to IRQ5

E8 - E9 jumped connects IDE IRQ to IRQ2 (default)

E8 - E9 open connects IRQ2 to the Expansion Bus

Tandy 1000TL/2 Audio Interface board (figure 225):

E11 - E12 jumped when a line audio input is connected to the microphone jack.

E12 - E13 jumped when a microphone input is connected to the microphone jack
(default)

```
*****  
*                                     *  
*                                     *  
*   T A N D Y   1 0 0 0 T L / 3   *  
*                                     *  
*                                     *  
*****
```

TANDY COMPUTER PRODUCTS

Introduction:

The Tandy 1000TL/3 utilizes the 80L286 microprocessor operating at a clock speed of 10 Mhz. Other features include 640KB of RAM upgradable to 768KB, one 720KB floppy disk drive with support for 1.2MB and 1.44MB floppy drives, MS-DOS and Deskmate® Desktop in ROM, speech and sound capabilities, Tandy graphics adapter and Hercules compatible video, 2 joystick ports, a PS/2 style mouse port, 9 pin serial port, DB-25 PC compatible parallel printer port and 101 key keyboard. The standard Tandy 1000TL/3 comes equipped with:

- * 10 Mhz 80L286
- * 640KB RAM consisting of four 256K x 4 bit, 100ns chips (512K) and four 64K x 4 bit 100 nS chips (128K video RAM)
- * RAM expansion sockets (U4 - U7) to increase RAM size to 768KB by adding four 64K x 4 bit, 100ns RAM chips
- * MS-DOS version 3.30.23 and Deskmate® version 3.05.00
- * Four XT-style expansion slots allowing up to 10 inch long cards to be installed
- * One RS-232C serial port
- * One parallel printer port
- * Speech and sound support with a microphone input and external sound output on a separate sound satellite board
- * CGA/TGA/MGA/Hercules compatible RGB video port
- * Dual joystick controller
- * On board floppy disk controller that can support three floppy drives. Diskette media supported includes 360KB, 720KB, 1.2MB and 1.44MB densities
- * One 3 1/2" 720KB floppy disk drive
- * Enhanced 101-key, PS/2 style keyboard
- * PS/2 compatible mouse port
- * Real time clock with battery
- * IDE interface
- * Socket (U9) for 80287, 8 MHz math coprocessor

There is a SETUPTL3 file on the Tandy 1000TL/3 DOS diskette. This program must be run when performing floppy drive upgrades and altering certain system parameters. Also, running SETUPTL3/A will give you additional setup screens which control options such as video memory size, control of certain chip selects, network options, etc.. Using the /A option with this program should be executed with great care!

One option in setup allows changing the video mode between monochrome and color. This can also be accomplished by depressing the key sequence given below. Each word within the <> refers to a single key, not to the letters of the keys themselves. Executing this key sequence will cause the computer to reboot!

<CTRL><ALT><SHIFT><V>

TANDY COMPUTER PRODUCTS

Tandy 1000TL/3 Main Logic Board 25-1603 (figure 271):

ROM Size Select Jumper	E1 - E2* installed	4MB ROM enabled
	E3 - E4* installed	
Diskette Drive Controller Address Select	E6 - E7* installed	Primary address (03F0h - 03F7h)
	E7 - E8	Secondary address (0370h - 0377h)
Diskette Drive Connector Enable	E9 - E10 installed	Disabled
	E10 - E11* installed	Enabled
Interrupt Jumpers	E16 - E17 installed	HDIRQ=IRQ2
	E17 - E18* installed	HDIRQ=IRQ5
	E18 - E19 installed	VSYNC=IRQ5

Tandy 1000TL/3 Satellite Board (figure 271):

Microphone/Line Audio Input Jumper	E1 - E2 installed	Line level audio input enabled
	E2 - E3* installed	Microphone enabled
Earphone/Line	E4 - E5 installed	Line level audio output enabled
	E5 - E6* installed	Earphone enabled

Sony MP-F11W-72D 720K Drive Logic Board (figure 144):

DS0 Drive A Slide switch all the way to the rear of the drive.
 DS1 Drive B Slide switch second notch from the rear of the drive.
 Power is derived from ribbon cable (no separate power connector).
 Termination is internal to the drive.

Upgrade Options

The RAM on the main logic board may be upgraded by adding a 128KB Memory Kit (25-1078) to the four empty sockets U4 - U7.

An 80287 math coprocessor rated at 8 MHz (90-2191) can be installed in the empty socket U9. Also, there is an 80287XL math coprocessor (catalog number 900-2585) which works in all Tandy 286-based desktop computers.

A total of three floppy disk drives are supported in the Tandy 1000TL/3. A 720KB, 3 1/2" floppy disk drive comes standard with the computer. There is one 3 1/2" drive bay and one 5 1/4" drive bay that can be used for expansion.

(continued on next page)

TANDY COMPUTER PRODUCTS

The 5 1/4" expansion bay can accept a 5 1/4" floppy disk drive (25-1063) or using the 3 1/2" to 5 1/4" Disk Drive Adapter (25-1076), a 3 1/2" floppy disk drive (25-1075) can be installed.

The 3 1/2" drive bay can accept a 3 1/2" floppy disk drive (25-1075) or 3 1/2" Smart drive (25-1045 or 25-1046). It is possible to install floppy drives into all the existing drive bays, giving a total of three floppy disk drives installed in the system. In this circumstance, a Smart drive can still be installed using a Smart Drive Mounting Bracket available from National Parts.

TANDY COMPUTER PRODUCTS

```
*****  
*                                                                 *  
*                                                                 *  
*           T A N D Y   1 0 0 0 T X           *  
*                                                                 *  
*                                                                 *  
*****
```

Notes:

The Tandy 1000TX comes standard with 512K Main Memory and 128K Video Memory. In this configuration the computer will display 640K memory at bootup. The TX may be upgraded to 640K main memory, by adding four 150 nanosecond 64K X 4 RAM chips at U54-U57 and removing the E9-E10 jumper. In this configuration the computer will display 768K at bootup.

Floppy Drive Cable:

The Floppy Drive cable in this computer is unique and can not be substituted with any other existing cable. Pins 3,5,7,9,11,29,31 and 33 have been punched out on the cable between the drive 0 and drive 1 connectors to prohibit +5V and +12 volts supplied to Drive 0 to be routed to Drive 1. Failure to follow this procedure could result in damage to Drive 1 and/or the main logic board.

RAM Specification:

Organization	Access Time
256K X 1	150nsec
64K X 4	150nsec

Tandy 1000TX Main Logic Board 25-1600 (figure 136):

E1-E2	Enables serial port (Standard)
E3-E4	On: Selects Com 1 (Standard) Off: Selects Com 2
E9-E10	On: Selects 640K Main memory (Standard) Off: Selects 768K Main memory
E11-E12	Off: Printer select signal not used (Standard) On: Printer select signal enabled

Switch S2:

Position 1:	Off	Selects Composite Monochrome Monitor
	On	Selects Color RGB Monitor
Position 2:	Off	Disables on board Interrupt 5
	On	Enables on board Interrupt 5 (Standard)
Position 3:	Off	Disables on board Interrupt 6
	On	Enables on board Interrupt 6 (Standard)
Position 4:	Off	Disables on board Interrupt 7
	On	Enables on board Interrupt 7 (Standard)

Note: Jumper locations E5-E6 and E7-E8 shown on the drawing do not have staking pins in place and provide no user options.

Sony MP-F63-01D 3 1/2 inch 720K Floppy Disk Drive (figure 144):

DS0 Drive A Slide switch all way to rear of drive
DS1 Drive B Slide switch second notch from rear of drive
Termination is internal to the drive.

Tandy 1000TX "Cleburn" Version Main Logic Board 25-1600 (figure 205):

E1 - E2 on enables on board serial port (standard)
 off disables on board serial port
E3 - E4 on selects COM1 (standard)
 off selects COM2
E9 - E10 on selects 640K memory size (standard)
 off selects 768K memory size
E11 - E12 off ties SLCTIN* high (standard)
 on connects SLCTIN* to the printer

Note: Jumpers E7 - E8 are present on the board but provide no user option.

Switch S2

Position 1: off selects composite monochrome monitor
 on selects color RGB monitor (standard)
Position 2: off disables on board INT5
 on enables on board INT5 (standard)
Position 3: off disables on board INT6
 on enables on board INT6 (standard)
Position 4: off disables on board INT7
 on enables on board INT7 (standard)

Switch S3

Position 1 & 2 toward the inside of the board for Tandy 1000 standard keyboard operation

Position 1 & 2 toward the outside of the board is not supported

This page intentionally left blank.

TANDY COMPUTER PRODUCTS

```
*****  
*                                                                 *  
*                                                                 *  
*           T A N D Y   1 1 0 0 F D           *  
*                                                                 *  
*                                                                 *  
*****
```

TANDY COMPUTER PRODUCTS

Tandy 1100FD 25-3530 (figure 240):

The Tandy 1100FD Laptop Computer is based on the 8088-equivalent CPU, the NEC V20 microprocessor, operating at 8MHz. It contains MS-DOS and the Deskmate Graphical User Interface Desktop in ROM. The 1100FD standard configuration is shown below:

- .NEC V20 operating at 8 MHz
- .640K RAM on the main logic board
- .MS-DOS Version 3.30.40, Deskmate Desktop Version 3.03.01, and a spelling checker, all contained in ROM
- .One serial port on the main logic board
- .One parallel port on the main logic board
- .A dedicated modem port for an optional 2400 bps modem
- .A CGA reflective LCD video screen, with 640 x 200 resolution
- .A Real Time Clock on the main logic board
- .An 84 key enhanced keyboard
- .One 720K 3.5" floppy drive

The 1100FD uses a rechargeable battery (25-3536) rated for 6 VDC, accessible through a cover on the back of the unit. It uses a 9.5 VDC AC adapter. The charge condition of the battery, or whether the AC adapter is being used for recharging, is indicated through an LED above the F2 key. A charged battery should last 3-5 hours, depending on level of drive and screen usage.

Main Logic Board Jumpers

The 1100FD main logic board has four jumper options to permit any of: an enhanced BIOS ROM (IC209), an enhanced Deskmate ROM (IC210), or a different Character Generator ROM (IC302). The jumpers are surface mount "chip jumpers" soldered on the back (bottom) of the main logic board (see Figure 240). The default setting of the jumpers is shown in the table below. No options are presently known that would necessitate any change in these jumper settings.

J201	on	+5VDC	\	to IC209.1,
J202	off	SA15	/	BIOS ROM
J203	on	MASK17	IC210.30	\ on IC210, the
J204	off	+5VDC	IC210.30	/ Deskmate ROM
J205	on	SMEMR*	\	to IC210.24, the
J206	off	MASK16	/	Deskmate ROM
J301	on	+5VDC	\	to IC302.2, the
J302	off	Gnd	/	Character Generator ROM (CGR)

TANDY COMPUTER PRODUCTS

Matsushita EME-213AMC 3 1/2 inch 720K Floppy Drive 25-3530 (figure 217):

This drive is for the 1100FD. There are NO jumpers on this drive.
Test points are as follows:

Head amp	TP1
Head amp	TP2
GND	TP3
Track 00	TP5
Index	Pin 23 of the floppy drive connector cable

Alignment is straight forward. Radial alignment is done by loosening the stepper motor screws and rotating the motor. Index timing is adjusted by loosening and adjusting a photo sensor that monitors holes in the rotating spindle. Track 00 is adjusted by loosening the track 00 sensor assembly and moving it as needed.

2400 Baud Internal Modem for Tandy 1100FD 25-3538 (figure 255):

This modem uses the standard Hayes command set. There are no jumpers on this board. Use SETUP_11.COM to set the communication port for internal modem operation.

This page intentionally left blank.

TANDY COMPUTER PRODUCTS

```
*****  
*                                           *  
*                                           *  
*           T A N D Y   1 2 0 0           *  
*                                           *  
*                                           *  
*****
```

TANDY COMPUTER PRODUCTS

Tandy 1200 Main Logic Board (figure 44):

This Main Logic board has five 8 bit expansion slots. Switch 1 (S1) and switch 2 (S2) are both 8 position dip switches. They will be configured differently depending on the options added to the basic unit. If more than one setting is included after the switch position the first one is the standard setting as it comes from the manufacturer.

S1-1 OFF Allows booting from floppy drive "A"
 S1-2 ON Indicates the co-processor (8087) is not installed
 OFF Indicates the co-processor IS installed
 S1-3 OFF Selects 256k RAM on board
 S1-4 OFF Selects 256k RAM on board

<u>S1-5</u>	<u>S1-6</u>	
OFF	OFF	Selects monochrome monitor or more than one monitor
OFF	ON	Selects color monitor in 40 x 25 mode
ON	OFF	Selects color monitor in 80 x 25 mode

S1-7 ON Indicates one floppy drive and one hard drive in system
 S1-8 ON Must be set ON at all times

Switch 2 determines the amount of RAM installed in the expansion slots. Note positions 6-8 are not used.

<u>RAM</u>	<u>S2-1</u>	<u>S2-2</u>	<u>S2-3</u>	<u>S2-4</u>	<u>S2-5</u>
None	OFF	OFF	OFF	OFF	OFF
64K	OFF	ON	ON	ON	ON
128K	ON	OFF	ON	ON	ON
192K	OFF	OFF	ON	ON	ON
256K	ON	ON	OFF	ON	ON
320K	OFF	ON	OFF	ON	ON
384K	ON	OFF	OFF	ON	ON

Tandy 1200A Main Logic Board (figure 84):

This main logic board has seven 8 bit expansion slots. Switch 1 (S1) is an 8 position dip switch. It will be configured differently depending on the options added to the basic unit. If more than one setting is included after the switch position the first one is the standard setting as it comes from the manufacturer.

S1-1 OFF Allows booting from floppy drive "A"
 S1-2 ON Indicates the co-processor (8087) is not installed
 OFF Indicates the co-processor IS installed

(continued on next page)

TANDY COMPUTER PRODUCTS

Note: The 1200A can be upgraded to 640K on the main logic board. S1-3, S1-4, and JP1 determine how much RAM and what type of RAM chips are installed. JP1 is located between U51 and U64 with pin 1 near U51. The following configurations are possible with S1-3 and S1-4:

CONFIGURATION	S1-3	S1-4	JP1	MEMORY
Internal 256K	OFF	OFF	2-3	64K RAM chips installed at U79-U87 and U100-U108
Internal 384K	OFF	ON	1-2	256K RAM chips installed at U79-U87
Internal 640K	OFF	OFF	1-2	256K RAM chips installed at U79-U87 and U100-U108
External 640K	OFF	OFF	2-3	64K RAM chips installed at U79-U87 and U100-U108 and Captain Multi-Function board installed.

S1-5 S1-6

OFF	OFF	Selects monochrome monitor or more than one monitor
OFF	ON	Selects color monitor in 40 x 25 mode
ON	OFF	Selects color monitor in 80 x 25 mode

S1-7 ON For 1200 HD; Indicates one floppy drive and one hard drive

OFF For 1200 FD; Indicates two floppy drives

S1-8 ON Must be set ON at all times

NOTE: On some Gate Array logic boards there is an LPT1 jumper located on the left side between RP6 and U41. When installed, this jumper enables the on board printer port. Refer to Technical Bulletin 1200:6 for when this jumper should be removed.

Floppy Drive Controller Board (figure 45):

J2 Connects 16 MHZ clock to FDC logic

Hard Drive Controller Board (figure 46):

E17-E18 Connects VCO into circuit

NOTE: There are several jumpers labeled on the board that have no staking pins. These jumper positions use traces rather than plugs. To change these options the trace must be cut on the PCB. Radio Shack® has none of the traces cut at this time.

Tandon TM100-2 5 1/4" Floppy Drive Logic Board (figure 47):

Dip Shunt (1E) All broken except 3-14 drive select 1

Terminating resistor pak (220/330 ohm) should be installed at location 2F

The following are wires not jumper plugs.

W1 Selects double sided drive

W2 Disables set/preset on write flip-flop

W4 Enables write protect control

W6 Activity LED is controlled with drive select signal

W8 Allows drive to be selected via J1 pin 6

TANDY COMPUTER PRODUCTS

Tandon TM-502 Internal 10 Meg Hard Drive Logic Board (figure 48):

S1 Drive select 1 (also labeled as W12)

W7 Terminates the read data lines

W8 Terminates the write data lines

Terminating resistor pak (220/330 ohm) should be installed at location U22

Tandy 1200 WD1002S-WX2 (short) Hard Drive Controller Board (figure 99):

W1 pins 1-2 Connects 'DSEL0' (drive select) to bus

W2 pins 1-2 Connects 'RG' (read gate) into circuit

W3 pins 1-2 Connects 'ROMEN' (ROM enable) to ROM

W4 pins 2-3 Connects 'A2' (address line 2) for address select

W6 pins 2-3 Connects 'RWC' (reduced write current) to J1 (drive)

W7 pins 1-2 Selects IRQ5

The following are eight (8) sets of jumpers labeled SW1 positions 1-8.

Notice that they are numbered from the bottom 1 through 4 and then backwards 8 through 5.

Position 5	OFF	Selects IRQ5
Position 6	OFF	Selects address
Position 7	OFF	Selects address
Position 8	OFF	Selects address
Position 4	With position 3	selects Drive D type
Position 3		(See below for drive types)
Position 2	With position 1	selects Drive C type
Position 1		(See below for drive types)

DRIVE C:	1	2	DRIVE D:	3	4
35 MEG	ON	OFF	35 MEG	ON	OFF
15 MEG	OFF	OFF	15 MEG	OFF	OFF
10 MEG	OFF	ON	10 MEG	OFF	ON

Tandy ROM
62-000052-010

DRIVE C:	1	2
10 MEG	OFF	ON

Tandon ROM
62-000040-03

DRIVE C:	1	2
10 MEG	OFF	OFF

IMPORTANT NOTE: The Tandy 1000 WD1002S-WX2 controller and the Tandy 1200 WD1002S-WX2 (short) controller board appear identical but they ARE different and are not interchangeable. Refer to the Hard Drive chapter notes for help in identifying the two boards.

Tandon TM65-2L Floppy Drive Logic Board (figure 98):

This drive is used only in the dual floppy version of the Tandy 1200.

DS1 Both floppy drives in system have DS1 as the cable selects the drive.

J34 B-C Spindle motor controlled by drive select

```
*****  
*                                                                 *  
*                                                                 *  
*           T A N D Y   1 4 0 0 F D / H D           *  
*                                                                 *  
*                                                                 *  
*****
```

TANDY COMPUTER PRODUCTS

Tandy 1400FD/HD 25-3501/05 (figure 228):

The Tandy 1400FD Laptop Computer is based on the 8088-equivalent CPU, the NEC V20 microprocessor, operating at a switchable 8.00/4.77 MHz. The 1400FD standard configuration is shown below:

- .NEC V20 CPU operating at 8.00/4.77 MHz
- .768K RAM on the main logic board
- .One serial port on the main logic board
- .One parallel port on the main logic board
- .Optional 1200 or 2400 bps, Hayes-compatible modem in main case
- .Backlit "Supertwist" LCD video screen, 640 x 200 resolution. Can optionally use an external RGBI color monitor.
- .Real Time Clock on the main logic board
- .76 key full size keyboard, or optionally an external keyboard
- .2 720K 3.5" internal disk drives, a 3rd external drive optional
- .Optionally upgradable to the 1400HD configuration (see below)

The 1400FD (25-3501) has a rechargeable battery rated at 12 VDC, accessible through a cover on the back left side of the case. It uses a 12 VDC AC adapter rated at 1.2A for recharging. Battery condition or recharge status is indicated by an LED.

The Tandy 1400HD (25-3505) is identical to the Tandy 1400FD (25-3501) except that a 20M 3.5" 1" form-factor Hard Drive is substituted for one of the 720K 3.5" Floppy Drives and that the 12 VDC adapter used is rated at 2.2A. Jumpers are identical to those of the Tandy 1400FD.

Note that the 1400FD main logic board is made by Sanyo, and is not the same as that of the 1400LT.

Main Logic Board Jumpers and Switches

The 1400FD/HD has two staking pin jumpers on the main logic board: the default setting is both jumpers off. The description of the jumpers is noted below, corresponding to Figure 228:

JP001	*off	+5VDC	\	to U007.2	A12
	on	Gnd	/		
JP002	*off	+5VDC	\	to U007.23	A11
	on	Gnd	/		

* denotes standard settings

There is a user accessible switch which permits switching the boot device from an internal drive to the external drive.

There is a Setup menu which allows the user to change some of the functions of the 1400FD/HD. To enter this setup mode, press the CTRL, ALT, and INS keys at the same time.

TANDY COMPUTER PRODUCTS

A math coprocessor can be installed by simply inserting it into location U27. It must be an 8087-2 device. No jumpers are needed for this installation.

TEAC FD235-136U 3 1/2 inch 720K Drive Logic Board (figure 218):

D0 Drive select 0.

D1 Drive select 1.

All other jumpers should be off.

Power is derived from ribbon cable (no separate power connector).

Termination is internal to the drive.

20 Meg (1400FD) 3 1/2" Hard Drive Kit 25-3516 (figure 234):

This drive has one set of three jumpers for factory testing on the left hand side of the drive (facing the drive indicator light). The three jumpers are set from the factory as follows and should not be changed:

DMW Jumped Wait Mode 1 Enabled

WM2 Jumped Wait Mode 2 Enabled (Spindle Motor OFF)

AG Not jumped Aging Test (Factory test mode)

There are no jumpers or switches on the controller board. Installation is straight forward. It should be used with DOS 03.30.00. Detailed instructions are in the hard drive installation guide.

The adapter that comes with this kit must be used once the hard drive is installed, as the original AC adapter does not supply enough current to the hard drive. Also, due to a manufacturing difference between the 1400LT and 1400FD the power supplies used are NOT compatible between machines. For more information on adapters see Technical Bulletin PORTABLES:4.

Parts that come in the kit:

- (1) Hard Disk Controller Connector
- (1) Hard Disk Controller Card
- (1) Hard Disk Drive
- (2) HDD Mounting Bracket
- (1) RF shield
- (1) Hard Disk Controller Cable
- (1) Plastic Spacer
- (3) Screws
- (1) Fan
- (1) AC Adapter
- (1) Bad Sector Label

This page intentionally left blank.

TANDY COMPUTER PRODUCTS

```
*****  
*                                                                 *  
*                                                                 *  
*           T A N D Y   1 4 0 0 L T           *  
*                                                                 *  
*                                                                 *  
*****
```

TANDY COMPUTER PRODUCTS

Tandy 1400LT 25-3500/A (figure 226):

Tandy 1400LT 25-3500B (figure 227):

The Tandy 1400LT Laptop Computer is based on the 8088-equivalent CPU, the NEC V20 microprocessor, operating at a switchable 7.14/4.77 MHz. The 1400LT standard configuration is shown below:

- .NEC V20 CPU operating at 7.14/4.77 MHz
- .768K RAM on the main logic board
- .One serial port on the main logic board
- .One parallel port on the main logic board
- .Optional 1200 or 2400 bps, Hayes-compatible modem in main case
- .Backlit "Supertwist" LCD video screen, 640 x 200 resolution. Can optionally use an external RGBI color monitor, or composite video
- .Real Time Clock on the main logic board
- .76 key full size keyboard
- .2 720K 3.5" internal disk drives, a 3rd external drive optional

The difference between the 1400LT 25-3500/A version and the 1400LT 25-3500B version is that the original 25-3500/A version had 512K of expansion memory on a separate memory board which occupied a card slot below the hard drive controller slot. With the 25-3500B version, the memory that was on this separate memory board was incorporated on the main logic board. Jumpers and switches are the same for both versions of main logic board.

The 1400LT has a rechargeable battery rated at 12 VDC, accessible through a cover on the back left side of the case. It uses a 15 VDC AC adapter for recharging. Battery condition or recharge status is indicated by an LED.

Note that the 1400LT main logic board is made by Citizens, and is not the same as that of the 1400FD/HD.

There is a Setup menu which allows the user to change some of the functions of the 1400LT. To enter this setup mode, press the CTRL, ALT, and INS keys at the same time.

A math coprocessor can be installed by simply inserting it into location U9. It must be an 8087-2 device. No jumpers are necessary.

Main Logic Board Jumpers and Switches

The Tandy 1400LT has no jumpers on the main logic board. There is a two position DIP switch on the main logic board, noted in Figure 226 and 227 as Dip Switch 1. The default setting for both DS1-1 and DS1-2 is off. The description of the switch settings is shown below:

DS1-1	*off	Internal Use	\	address 4000:0-9000:FFFF
	on	External Use	/	
DS1-2	*off	Internal Use	\	address DC00:0-EC00:FFFF
	on	External Use	/	

* denotes standard position

User accessible switches permit switching between the LCD and an external monitor (SW2), and switching the boot drive from an internal drive to the external drive (SW3).

Citizen OPBD-12A 3 1/2 inch 720K Floppy Drive (figure 213):

DS0 Drive A - Slide switch all the way to the rear of the drive.
 DS1 Drive B - Slide switch second notch from the rear of the drive.
 Termination is internal to the drive.

Citizen OSDC-95A 3 1/2 inch 720K Floppy Drive (figure 160):

DS0 Drive A - Slide switch all the way to the rear of the drive.
 DS1 Drive B - Slide switch second notch from the rear of the drive.
 Termination is internal to the drive.

20 MEG CMS (1400 LT) 3 1/2" Hard Drive 25-3515 (figure 174):**20 MEG CMS (1400 LT) 3 1/2" Hard Drive Controller 25-3515 (figure 175):**

This drive has no jumpers or drive select. There are also no jumpers or switches on the controller board. Installation is straight forward. It should be used with MS-DOS version 03.20.04. Refer to Technical Bulletin PORTABLES:2 for detailed installation instructions. Be SURE that the hard drive controller power cable has a fuse in series with a current limiting resistor paralleled with a diode in line between the power supply and the battery. Without these components, extensive battery damage WILL occur.

The adapter that comes with this kit must be used once the hard drive is installed, as the original AC adapter does not supply enough current to the hard drive. Also, due to a manufacturing difference between the 1400LT and 1400FD the power supplies used are NOT compatible between machines. For more information on adapters see Technical Bulletin PORTABLES:4.

(continued on next page)

TANDY COMPUTER PRODUCTS

DOS version 03.20.04 comes with a RAMDISK option installing as a C: drive. This will interfere with the PREP.EXE program which performs a low level format. Make sure to rename the CONFIG.SYS and AUTOEXEC.BAT files temporarily in order to allow PREP.EXE to format properly. If you do not allow for this, an "Invalid Partition" message will occur after the low level formatting.

Parts that come in the kit:

- (1) Hard Disk Drive
- (1) Controller Card
- (1) LiteDrive Utilities Disk
- (3) Plastic Hex nuts (usually on the drive)
- (1) AC Adapter (15V @ 1600 MAH)

*The control and power cables will be attached to the controller card.

1400LT Internal Modem Board 25-3510 (figure 195):

The 25-3510 modem has one jumper. It is labeled as W1. It is only set when an older 1A2 multi-line phone system is in use. It connects the A and A1 leads of the station wire together to enable the busy lamp for the CO line it is connected to.

To self test the modem type in the command:

```
AT S16=1 C1 D<CR>
```

The modem will respond:

```
CONNECT
```

Each key pressed will be echoed back to the screen.

To exit the test enter:

```
+++
```

Do NOT enter <CR> after +++.

TANDY COMPUTER PRODUCTS

```
*****  
*                                           *  
*                                           *  
*   T A N D Y   1 5 0 0 H D   *  
*                                           *  
*                                           *  
*****
```

Tandy 1500HD Laptop Computer 25-3506 (figure 267):

The Tandy 1500HD laptop computer is based on an 8088 compatible 10MHz NEC V20 microprocessor. The unit comes standard with a 2.5" 20 MB hard drive preconfigured with MS-DOS and DeskMate and a 1/4 height 3.5" 1.44 MB floppy disk drive. The 1500HD standard configuration includes:

- * NEC 10 MHz V20 microprocessor
- * 640K RAM, expandable to 1.64 MB
- * One Conner CP-2024 2.5" 20MB hard drive
- * One Matsushita EME-263MG 3.5" 1.44 MB floppy drive
- * CGA compatible LCD display panel with fluorescent backlight (640 x 200 resolution)
- * One standard DB-25 parallel printer port
- * One standard DB-9 serial port
- * Dedicated modem port for optional 2400 bps modem
- * 84 key keyboard (full 101 key compatibility)
- * Battery backed up Real Time Clock

The unit may be powered by either 12V, 1.4Ah rechargeable nicad battery (25-3526) or 9.5V DC input supplied from an A.C. adapter. The A.C. adapter is rated for 2.1A.

Main Logic Board Jumpers and Switches**SW1**

- 1 *OFF Normal operation
- ON Swaps the functions of the Ctrl and Caps Lock keys
- 2 *OFF No function

TC1 Adjusts Real Time Clock

VR1 Adjusts LCD contrast

Hardware Setup command is SETUP_15.COM

Conner CP-2024 2 1/2 inch 20MB Hard Drive 25-3506 (figure 299):

The hard disk drive is a 20MB 2.5" Conner CP-2024. The jumper settings are:

Drives in System	E1	E2
* Single Drive System	Not Installed	Installed
Master of Two Drive System	Installed	Installed
Slave of Two Drive System	Not Installed	Not Installed

* = Indicates Factory Setting

TANDY COMPUTER PRODUCTS

Matsushita EME-263MG 3 1/2 inch 1.44M Floppy Drive 25-3506 (figure 300):

This drive is for the 1500HD/2810/3810HD. There are no jumpers on this drive. The test points are as follows:

Head Amp	TP1
Track 00 Check	TP5
Track 00 Bias	TP6 (Shorting it to ground enables Track 00 check)
Index	Pin 2 of the floppy drive connector cable
Read Data	Pin 24 of the floppy drive connector cable
Head 0 Connect	CN1
Head 1 Connect	CN2
VCC (+5V)	CN8 Pins 1,3,5,7
Ground	CN8 Pins 13,15,17,19,21,23,25

This drive is interfaced through a soldered on flat conductor cable instead of the conventional ribbon cable.

1 MB EMS SIMM Memory Module 25-3507 (figure 278):

The SIMM module plugs into a single SIMM socket located underneath the access panel above the keyboard. It has 1 MB of memory, rated at 80 nsec. There are no jumpers or switches to change. However, a line must be in the CONFIG.SYS file to use the extra memory, as follows:

```
DEVICE=C:\DOS\TEMM1500.SYS
```

2400 Baud Modem for the 1500HD/2810HD/3810HD 25-3525 (figure 280):

There are no jumpers for this modem. It is installed beneath the two inch wide access panel adjacent to the battery. The modem is connected to the main logic board via a single flat cable and secured in position upside down with two screws.

This page intentionally left blank.

TANDY COMPUTER PRODUCTS

```
*****  
*                                           *  
*                                           *  
*           T A N D Y   2 0 0 0           *  
*                                           *  
*                                           *  
*****
```

TANDY COMPUTER PRODUCTS

Tandy 2000 Main logic board (figure 49):

E4-E5 Connects count pulse to video PLL chip
E7-E8 Selects 250nS precomp
E9-E12 Connects DS0 from FDC to drive select latch (U30.15)
E10-E16 Connects DS0 from drive select latch to J11.10
E11-E15 Connects DS1 from drive select latch to J11.12
E13-E14 Connects DS1 from FDC to drive select latch (U30.14)

Note: The above are jumper wires not plugs.

Mitsubishi M4853 5 1/4" (figure 40):

3, 4, 5, 6, 7, 8, and 9 are for termination and should only be installed on the last drive on the cable.

DSx Drive Select (x = 0-3)
HC Causes a constant head load condition
MM Causes motor on when drive is selected
H1 Routes ready signal R3 to the head load circuitry
R3 Establishes a ready signal when a diskette is inserted in the drive and the door is closed.

Mitsubishi M4853-1 (Mark II) 5 1/4" (figure 50):

HC Selects constant head load after door closed
2S Selects constant drive ready
MM Selects active low motor on
DSx Drive select (x = 0-3)

The terminating resistor pak should be installed at location B6 on the last drive on the cable.

TANDY COMPUTER PRODUCTS

```
*****  
*                                     *  
*                                     *  
*   T A N D Y   2 5 0 0 S X   *  
*                                     *  
*                                     *  
*****
```

TANDY COMPUTER PRODUCTS

Tandy 2500SX 25-4076 (figure 276):**Introduction:**

The Tandy 2500SX is another low profile computer similar to the 2500XL/2. The major difference between the 2500SX and the 2500XL/2 is that the processor has been changed from an 80C286 to an 80386SX. The HT21 bus controller, or "AT on a chip" from Headland is still the main support component of the 80386SX processor. The familiar FDC controller, 16-bit SVGA controller, AT-style IDE hard drive interface, keyboard/mouse controller, RAM and PSSJ (printer, serial, sound {no joystick support}) round out the rest of the features packed onto the main logic board. MS-DOS version 5.0 and Deskmate version 3.5 are included with the 2500SX. Standard equipment includes:

- * 16 MHz 80386SX CPU.
- * Socket for an optional 16MHz 80387SX coprocessor.
- * 1 Meg. of on-board RAM (eight 256Kx4 80nS SMT RAMs).
- * Capable of up to 5 Meg. of total RAM on the main logic board.
- * Three 16 bit ISA compatible expansion slots.
- * 16 bit Super VGA graphics adapter built in.
- * 256K Video RAM expandable to 512K RAM.
- * One 1.44 Meg 3.5 inch diskette drive.
- * Expansion slots for one more 3.5" drive and one half height 5.25" drive.
- * On board dual speed floppy controller that supports 2 drives.
- * On board AT-style IDE Hard Drive interface.
- * On board 9-pin serial port.
- * On board 25-pin bidirectional parallel printer port located at I/O port 378H or 278H.
- * PS/2 style mouse/keyboard interfaces.
- * Enhanced PS/2 style 101-key keyboard.
- * 70 watt power supply.
- * Music and sound capability.
- * Chassis design allows easy subassembly access.

Setup:

The SETUPSX.COM utility is located on the first MS-DOS diskette. The setup screen is similar to the 4020/25/33 LX setup screen.

TANDY COMPUTER PRODUCTS

Jumpers:

The following list describes the possible jumper settings for the 2500SX. An asterisk (*) next to the jumper numbers denotes factory default settings.

E4,E5	Clear CMOS RAM	*Not Jumpered (no staking pins)
E14,E15	Video interrupt	*Not Jumpered, No Video Interrupt Jumpered = IRQ9 (See Note 1)
E11,E12,E13	On Board Video Enable	*E11-E12 enabled E12-E13 disabled
E16,E17,E18	VGA BIOS	*E17-E18 PS/2 mode E16-E17 AT mode
E22,E23	Power/IDE Activity LED	*Not Jumpered = Standard Power LED Jumpered = Power/IDE activity LED (Power LED blinks with IDE activity)
E19,E20,E21	Monitor Type	*E19-E20 standard VGA monitor or standard Multi-sync E20-E21 non-standard Multi-sync monitor
E24,E25,E26	Audio Input Source	*E24-E25 Microphone E25-E26 Line audio
E28,E29,E30	Audio Output Source	*E28-E29 Headphone E29-E30 Line audio

NOTE 1: IRQ9 is software mapped to IRQ2 per the AT standard.

Floppy Drive (figure 141):

The floppy drive is a Sony MFD-17W-72 1.44 Meg 3.5 inch drive. The following is a list of the test points and their functions:

Differential read amps	RFA, RFB
Direction	CN101, pin 18
Step	CN101, pin 20
Track 0	CN101, pin 26
Index	CN101, pin 8
Read Data	CN101, pin 30
Ground	CN101, pin 13
Write Protect	CN101, pin 28
Motor On	CN101, pin 16

The drive is internally terminated. There is a single drive select switch on the side. Drive A: should be set for DS0, Drive B: should be set for DS1, etc. If a 5 1/4" drive is added to the system, it must also be terminated.

Upgrade Options:

RAM expansion is accomplished by adding either 256K or 1 Meg SIMM's to sockets J1, J5, J6, and J9. The supported memory configurations are: 1 Meg (empty), 1.5 Meg (2, 256K x 9), 2 Meg (4, 256K x 9), 3 Meg (2, 1 Meg x 9), and 5 Meg (4, 1 Meg x 9). Bank A (which may be labeled Bank 4 and is at connectors J6, J9) is to be used for the configurations that use only two SIMM modules. Using 16 bit memory expansion boards (Catalog number 900-2400), the system could be brought up to a maximum of 16 Meg of RAM.

IDE, SCSI, ESDI or MFM hard drives can be used with the 2500SX, but Hard Cards of any type are NOT supported. The physical size of the hard drive is limited to a 5.25" half height device or smaller. The 5.25" drive bay or the 3.5" bays can be used. When using the 5.25" mount, a standard half height hard drive is allowed. When using a 3.5" drive in the 3.5" bays, use a 1" tall hard drive. Remember, IDE drives are already low level formatted. Do NOT run HSECT on IDE drives.

The 2500SX has 256K of video memory soldered to the main logic board at U58, and U54. To access the Super VGA modes an additional 256K of video memory must be installed at U48 and U50. This kit can be ordered under part number MX-3750 under catalog number 25-4075.

Service Notes:

The expansion backplane has three 16-bit ISA slots and plugs into the main logic board. These slots can support a variety of expansion cards up to 13 inches in length. Be aware that there are some older 8-bit expansion cards that will not fit because they extend into the 16-bit connector.

When reassembling the unit, take care to dress your cables properly. Due to the position of the IDE and power connectors used, and the amount of cabling, the carriage could easily crimp cables or trap unused connectors against the main logic board (warping it).

CAUTION: When closing the carriage KEEP YOUR FINGERS OUT OF THE WAY!

As the drive carriage moves into it's resting place, the end closest to the expansion backplane passes by the front grill with a shearing action. The edges are SHARP! Exercise caution when closing the drive carriage.

```
*****  
*                                                                 *  
*                                                                 *  
*           T A N D Y   2 5 Ø Ø X L           *  
*                                                                 *  
*                                                                 *  
*****
```

TANDY COMPUTER PRODUCTS

Tandy 2500XL 25-4074 (figure 235):

The Tandy 2500XL is one of a series of low profile computers. This is an AT class machine utilizing an 80286 microprocessor, Headland G2 support LSIs, an FDC controller, a 16 bit VGA controller, an AT-style IDE hard drive interface, a mouse port, a serial port, and a parallel port, all on the main logic board. This unit, though similar to the Tandy 3000 line, has MSDOS 3.3 and Deskmate in ROM like the current Tandy 1000 family. The unit stands only 4.5 inches high. Standard equipment includes:

- * 10 MHz 80286 CPU.
- * Full Speed Bus option (10MHz) makes the unit faster than a 12MHz 3000 (6MHz Bus).
- * Socket for an optional 80287 coprocessor.
- * 1 Meg. of RAM (four 256Kx9 100nS SIMMs).
- * Capable of up to 4 Meg. of RAM on board total
- * Three 16 bit AT compatible expansion slots.
- * 16 bit VGA graphics adapter built in.
- * One 1.44 Meg. 3.5 inch diskette drive.
- * Expansion slots for one more 3.5" drive and one half height 5.25" drive.
- * On board dual speed floppy controller supports 3 drives.
- * On board AT-style IDE hard drive interface.
- * On board serial port.
- * On board parallel printer port.
- * Enhanced PS/2 style 101-key keyboard.
- * PS/2 style mouse interface.
- * 70 watt power supply.
- * Full music and sound capability.
- * Carriage style chassis for easy subassembly access.

Main Logic Board

The main logic board contains all the circuitry necessary for system operation. All system memory is installed on the main logic board. There are four SIMM sockets for this purpose. Using 1 Meg SIMMs limits system memory to 4 Meg on board. The actual supported steps are: 1 Meg (4, 256Kx9), 2 Meg (2, 1Mx9), and 4 Meg (4, 1Mx9). Using 16 bit expansion boards the system could be brought up to a maximum of 15 Meg of RAM.

TANDY COMPUTER PRODUCTS

Jumpers:

E1-E3	CMOS RAM clear	Shorting these pins clears the CMOS RAM contents for reprogramming.
E2,4,8	Expansion Bus Speed	E2-E4 Full speed bus. (default) The CPU and Bus speeds are locked together and change with the speed setting in SETUP. E4-E8 Half speed bus. Only the CPU speed changes with SETUP. The bus is locked at low speed.
E5,6,7	Memory Parity Check	E6-E7 Enabled (default)** E5-E6 Disabled
E9,10,11	BIOS ROM Type	E9-E10 Two 32Kx8 EPROMS E10-E11 4 or 8Meg ROM (default)
E12,13	Video interrupt	No Jumper Installed (default) E12-E13 IRQ9*
E14,15,16	On Board Video Enable	E15-E16 enabled (default) E14-E15 disabled
E17,18,19	Audio Input Source (from MIC jack)	E18-E19 Microphone (default) E17-E18 Line audio

* NOTE: IRQ9 is software mapped to IRQ2 per the AT standard.

** NOTE: The early version of the user's manual is wrong with respect to the memory parity check jumpers. This document and the schematic are correct.

FLOPPY DRIVE (figure 141):

The floppy drive is a new Sony MP-17W-72. It is a relative of the 1.44 Meg MP-17W-70D found in the 4016SX. Here are the drive's test points:

Differential read amps:	RFA, RFB
Direction:	CN101, pin 18
Step:	CN101, pin 20
Track 0:	TRK0
Index:	CN101, pin 8
Raw data:	CN101, pin 30
Ground:	AGND
Write protect:	WPRT
Motor on:	CN101, pin 16

TANDY COMPUTER PRODUCTS

The drive is internally terminated. There is a single drive select switch on the side. Drive A: should be set for DS0, a second drive (B:) DS1, etc.. If a 5.25" drive is added it should be terminated. This unit will support up to 3 floppy disk drives.

Hard drives:

Use AT style IDE drives with the 2500XL. Hard cards are NOT supported. The physical size of the hard drive can be a limitation. Two sizes of hard drives can be mounted. The 5.25" drive bay or the 3.5" bays can be used. When using the 5.25" mount, a standard half height hard drive is allowed. When using a 3.5" drive in the 3.5" bays, use a 1" tall hard drive. Remember, IDE drives are already low level formatted. Do not run HSECT on IDE drives.

The SETUP utility:

The SETUPXL.COM utility is located on the DOS diskette and is very similar to those used in the Tandy 1000TLs. A setup screen appears listing the various options.

Service Notes: The expansion backplane can be removed by removing two screws holding the backplane bracket to the chassis. One of these screws is at the rear, just above the keyboard connector. The other screw is at the front of the chassis.

There is no -5 Volts circuit on the main logic board. The -5 Volts is derived from the -12 Volts with the help of a -5 Volt regulator mounted on the expansion backplane. This means that a 2400 Baud modem plugged directly into the main logic board would not work (no -5V). The modem would have to be inserted into the expansion backplane (which has -5V).

When reassembling the unit, watch your cable dress! The carriage could easily crimp cables or trap unused connectors against the main logic (warping it).

When closing the carriage KEEP YOUR FINGERS OUT OF THE WAY. As the drive carriage moves into its resting place, the end closest to the expansion backplane passes by the front grill with a shearing action. The edges are SHARP! Later models will have dulled edges but still be careful.

```
*****  
*                                                                 *  
*                                                                 *  
*           2 5 Ø Ø X L / 2           *  
*                                                                 *  
*                                                                 *  
*****
```

Tandy 2500XL/2 25-4075 (figure 270):**Introduction:**

The Tandy 2500XL/2 is an AT class machine which utilizes "AT on a chip" technology from Headland. The improvements to the support of the 80C286 microprocessor are the Headland HT21 bus controller, and a clock generator called GESUALDO. The familiar FDC controller, 16-bit SVGA controller, AT-style IDE hard drive interface, keyboard/mouse controller, RAM and PSSJ IC (printer, serial, sound {no joystick ports}) round out the rest of the features packed onto the main logic board. MS-DOS and Deskmate in ROM have been carried forward from the 2500XL. Standard equipment includes:

- * 16 MHz 80C286 CPU.
- * Socket for an optional 10MHz 80287 coprocessor.
- * 1 Meg. of on-board RAM (eight 256Kx4 80nS SMT RAMs).
- * Capable of up to 5 Meg. of total RAM on the main logic board.
- * Three 16 bit ISA compatible expansion slots.
- * 16 bit Super VGA graphics adapter built in.
- * 256K Video RAM expandable to 512K RAM.
- * One 1.44 Meg 3.5 inch diskette drive.
- * Expansion slots for one more 3.5" drive and one half height 5.25" drive.
- * On board dual speed floppy controller that supports 2 drives.
- * On board AT-style IDE hard drive interface.
- * On board 9-pin serial port.
- * On board 25-pin bidirectional parallel printer port located at I/O port 378H or 278H.
- * PS/2 style mouse/keyboard interfaces.
- * Enhanced PS/2 style 101-key keyboard.
- * 70 watt power supply.
- * Music and sound capability.
- * Chassis design allows easy subassembly access.

Main Logic Board Jumpers:

The following list describes the possible jumper settings for the 2500XL/2. An asterisk (*) next to the jumper numbers denote the factory default settings.

E9,E10,E11	BIOS ROM Type	E9-E10 Two 32Kx8 EPROMS *E10-E11 4 or 8 Meg. ROM
E17,E18	Video interrupt	*Not Jumpered, No Video Interrupt E17-E18 IRQ9 (See Note 1)
E14,E15,E16	On Board Video Enable	*E14-E15 enabled E15-E16 disabled

(continued on next page)

TANDY COMPUTER PRODUCTS

E19,E20,E21	VGA BIOS	*E20-E21 PS/2 mode E19-E20 AT mode
E22,E23,E24	Monitor Type	*E22-E23 standard VGA monitor or standard Multi-sync E23-E24 non-standard Multi-sync monitor
E25,E26,E27	Audio Input Source	*E25-E26 Microphone E26-E27 Line audio
E28,E29,E30	Audio Output Source	*E28-E29 Headphone E29-E30 Line audio
E31,E32,E33	Front Panel LED	*E31-E32 Power LED Only E32-E33 Power LED/IDE Activity LED (it blinks when there is IDE activity)

* NOTE 1: IRQ9 is software mapped to IRQ2 per the AT standard.

Teac FD-235HF-106U 1.44 Meg 3.5 inch floppy drive (figure 275):

The floppy drive is a Teac FD-235HF-106U 1.44 Meg 3.5 inch drive. There are two sets of jumper blocks located at the rear of the floppy drive. The following is a list of the jumpers and their functions:

FG: Frame ground. This is permanently jumpered.
D0: Drive select zero. (default)
D1: Drive select one.
HHI: Logic HI sets the drive in high density mode (not used).
LHI: Logic LOW sets the drive in high density mode (not used).
OP: High density switch enabled (jumpered).
HHO: High density output on high (not used).

D2: Drive select two. Connect the middle pin to the D2 pin.
D3: Drive select three. Connect the middle pin to the D3 pin.

Upgrade Options:

RAM expansion is accomplished by adding either 256K or 1 Meg. SIMM's to sockets J1, J5, J6, and J9. The supported memory configurations are: 1 Meg (empty), 1.5 Meg (2,256K x 9), 2 Meg (4,256K x 9), and 3 Meg (2,1 Meg x 9), and 5 Meg (4, 1 Meg x 9). Bank 3 (J1,J5) is to be used for the configurations that use only two SIMM modules. Using 16 bit memory expansion boards, the system could be brought up to a maximum of 16 Meg of RAM.

(continued on next page)

TANDY COMPUTER PRODUCTS

IDE, SCSI, ESDI or MFM hard drives can be used with the 2500XL/2, but Hard Cards of any type are NOT supported. The physical size of the hard drive is limited to a 5.25" half height device or smaller. The 5.25" drive bay or the 3.5" bays can be used. When using the 5.25" mount, a standard half height hard drive is allowed. When using a 3.5" drive in the 3.5" bays, use a 1" tall hard drive. Remember, IDE drives are already low level formatted. Do NOT run HSECT on IDE drives.

The 2500XL/2 currently has 256K of video memory soldered to the main logic board at U50, and U54. To access the Super VGA modes an additional 256K of video memory must be installed at U44 and U46. This kit can be ordered under part number MX-3750 under catalog number 25-4075.

Three AT compatible expansion slots are provided. These slots can support a variety of expansion cards up to 13 inches in length.

Service Notes:

The expansion backplane has three 16-bit ISA slots and plugs into the main logic board. This board can be removed by unscrewing the two screws holding the backplane bracket to the chassis. One of these screws is at the rear, just above the keyboard connector. The other screw is on the front of the chassis.

When reassembling the unit, take care to dress your cables properly. Due to the position of the IDE and power connectors used, and the amount of cabling, the carriage could easily crimp cables or trap unused connectors against the main logic board (warping it).

CAUTION: When closing the carriage KEEP YOUR FINGERS OUT OF THE WAY!

As the drive carriage moves into its resting place, the end closest to the expansion backplane passes by the front grill with a shearing action. The edges are SHARP!

```
*****  
*                                                                 *  
*                                                                 *  
*           T A N D Y   2 8 0 0 H D           *  
*                                                                 *  
*                                                                 *  
*****
```

TANDY COMPUTER PRODUCTS**Tandy 2800HD 25-3550 (figure 241):**

The Tandy 2800HD Laptop Computer is based on the Intel 80C286-12 (low current version) operating at 12 or 6 MHz. Its basic configuration is shown below:

- .80C286-12 operating at a switchable 12/6 MHz
- .MSDOS 3.30.30 and the Deskmate Desktop in ROM
- .1 Meg of RAM on main logic board
- .One serial port on the main logic board
- .One parallel port on the main logic board
- .Expansion slot for an internal 2400 bps modem
- .Built-in EGA compatible backlit "Supertwist" LCD display with 640 x 400 resolution. Optional on-board external EGA/CGA video port.
- .Real Time Clock on the main logic board
- .84 key full sized keyboard. Optional use of external keyboard.
- .Optional 80C287A-12 Co-processor expansion
- .1 1.44M 3.5" Floppy Drive, and 1 20M IDE AT Hard Drive

The Tandy 2800HD uses a rechargeable 6VDC battery and a 9.5 VDC AC adapter charging unit. The battery is accessible at the back of the top case.

Tandy 2800HD Jumpers and Switches

There is a user accessible 4-position DIP switch on the right side of the 2800HD, hidden by a latched door. It is located on a satellite to the main logic board. The following table describes the functions of these switches (see Figure 241):

SW1	down (on, closed) up (off, open)	internal LCD display external monitor display
SW2	down (on, closed) up (off, open)	EGA display CGA display

SW3, SW4 are reserved (not used, default down position)

There are three sets of jumpers on the main logic board (see Figure 241), with the following functions:

E1 E2	Not jumpered	for clearing the CMOS RAM
E4 E5 E6	E4-E5 jumpered (default)	\ 512K BIOS ROM
E7 E8 E9	E7-E8 jumpered (default)	/ size select
	E4-E5-E6 not jumpered	\ 1 Meg BIOS ROM
	E7-E8 jumpered	/ size select
	E5-E6 jumpered	\ 2 Meg BIOS ROM
	E7-E8 jumpered	/ size select

At this writing, no options are available requiring movement of jumpers.

TANDY COMPUTER PRODUCTS

There are five variable resistors located on the power supply, used at the factory to adjust threshold voltages for various stages of battery low detection. **These resistors should not be adjusted in the field.**

Math Coprocessor

An 80C287A, or a 287XLT, PLCC math coprocessor can be installed into IC socket U11. No jumpers are necessary.

1 MB Memory Upgrade Board for 2800HD 25-3554 (figure 261):

There are no jumpers for this upgrade. This will increase the total memory to 2 MEG. The memory is LIM 4.0 Expanded Memory compatible.

Panasonic JU-257A213P 1.44 MEG Floppy Drive for 2800HD (figure 219):

SW1(RY/DC): Ready/Disk Change. Default is "DC".

SW2(MO/MS): Motor ON/Motor on Drive Select(MS). Default is "MO".

SW3(0321) : Drive Select. Default is Drive "0".

SW4(BCD) : Selects head assembly rank. This switch is used to match the logic board to the head. Set to letter marked on head assembly.

SW5(PS2/AT): Selects either PS2 polarity or AT polarity. Default is PS2.

Power supplied by I/O cable.

Conner CP-3024 20MEG Hard Drive for 2800HD (figure 242):

There are three connectors on this drive, the outside two are the power connectors (J3, which is the standard power connector, and J5 a 3-pin power connector) and the inner 40-pin header is the IDE port (J2). The configuration jumpers are located just behind the 3-pin power connector on the bottom of the drive (see figure 242).

ACT Provides signal to drive external LED

DSP/CD Determines # of drives and primary/secondary status

HSP Reserved for future use

Since only one hard drive is supported, only the settings for a single drive system are given.

Single IDE
Drive System

ACT Jumped
DSP Not jumped
C/D Jumped
HSP Not jumped

This page intentionally left blank.

```
*****  
*                                     *  
*                                     *  
*   T A N D Y   2 8 1  Ø H D   *  
*                                     *  
*                                     *  
*****
```

TANDY COMPUTER PRODUCTS

INTRODUCTION:

25-3551 281ØHD with 2Ø MEG hard drive

25-3552 281ØHD with 6Ø MEG hard drive

The 281ØHD contains a 8ØC286 microprocessor running at 16MHz. The computer comes standard with 1MB of RAM, expandable to 5MB on the main logic board. The video is a VGA compatible LCD display with a fluorescent backlight. A special "resume" function allows you to turn off your computer in the middle of an application without losing your place within the program. The standard configuration is:

- * 16MHz 8ØC286 CPU
- * Optional 8ØC287A or XLT Co-processor Socket
- * One Conner CP-2Ø24 2.5 Inch 2ØMB Hard Disk Drive
- * One Matsushita EME-263MG 3.5 Inch 1.44MB Floppy Disk Drive
- * MSDOS Version 4.Ø1 Operating System
- * Deskmate Version 3.5
- * BIOS ROM Version 3.1Ø.Ø1
- * Advanced Video BIOS ROM Version 1.1Ø.ØØ
- * VGA Compatible LCD Display with Fluorescent backlight
- * One DB-15 External VGA Port
- * One DB-25 Parallel Port / External Floppy Drive Port
- * One DB-9 RS-232 Serial Port
- * 84 Key Keyboard (1Ø1 Key Emulation)
- * External PS/2 Keyboard Port
- * Resume Function
- * One 12VDC 1.4AH Ni-Cad Rechargeable Battery
- * 1MB Onboard Memory
- * Maximum Memory Expansion 5MB
- * One 16VDC 1.25A AC Adapter

The setup for the 281ØHD is run from the "SETUP281" program which lies on the 281Ø MS-DOS operating disk.

MEMORY CONFIGURATIONS:

The 281ØHD comes standard with 1MB of RAM on the main logic board. Supported RAM configurations are 1MB, 3MB, or 5MB. Upgrades are done by adding double-sided 1MB 8Øns SIMM modules (25-35Ø7, figure 278). Two 25-35Ø7 memory kits are needed for the upgrade to 3MB and four are needed for the upgrade to 5MB. SIMM modules are located under a cover between the LCD display and the keyboard. Sockets CN1 and CN2 are used for the 3MB upgrade and sockets CN1, CN2, CN3, and CN4 are used for the 5MB upgrade. There are NO jumpers to set when memory is added.

POWER SUPPLY:

Power for the unit can be obtained from either a 12VDC 1.4AH Ni-Cad rechargeable battery (25-3526) or a 16VDC 1.25A AC adapter (WF-Ø334).

The Ni-Cad battery (25-3526) has a 2 to 4 hour charge time. The battery can run up to 3.5 hours under optimal conditions of continuous computing power. **The battery pack must be fully charged before using the computer.** Failure to fully charge the battery before use could greatly reduce the battery life and efficiency.

The AC adapter (WF-Ø334) has a 16VDC output and uses a positive center conductor and a negative outer conductor jack.

VIDEO DISPLAY:

The video display is a VGA compatible LCD display with a fluorescent backlight. The display uses blue characters and a white background. The backlight has 3 brightness settings; low, medium, and high which is controlled by a switch on the left side of the case.

The external video port is a fully compatible color VGA port.

KEYBOARD:

The keyboard is an 84 key keyboard that supports a 1Ø1 key emulation. The "CTRL" and "CAPS LOCK" keys have the ability to have their functions reversed. This is done by changing the position of a dip switch (SW2) that lies in a compartment under the battery. The switch settings are:

On - to reverse the "CTRL" and "CAPS LOCK" keys
Default > Off - to restore the standard "CTRL" and "CAPS LOCK" keys.

The external keyboard port supports a PS/2 style enhanced keyboard.

Tandy 281ØHD Main Logic Board (figure 268):

This unit contains 1 jumper (JP 33) that comes jumpered Pin 2 (CLK) to Pin 3 (16Mhz). The (CLK) signal is the co-processor clock. Do NOT move this jumper.

Conner CP-2Ø24 2Ø MEG IDE Hard Drive (figure 299):

The hard disk drive is a 2ØMB 2.5" Conner CP-2Ø24. The jumper settings are:

<u>Drives in System</u>	<u>E1</u>	<u>E2</u>
* Single Drive System	Not Installed	Installed
Master of Two Drive System	Installed	Installed
Slave of Two Drive System	Not Installed	Not Installed

* = Indicates Factory Setting

TANDY COMPUTER PRODUCTS

Conner CP-2064 60 Meg IDE Hard Drive (figure 283):

The 60 MEG version of the 2810HD contains a 60MB 2.8" Conner CP-2064 hard disk drive. The 2810 hard drive is preinitialized at the factory with MS-DOS and DeskMate, reinitialization if needed is done in three steps:

1. HSECT - Run HSECT.COM to low level format the drive. The hard disk type is 19, the drive's translation mode circuitry will emulate a drive with 566 cylinders and 13 heads.
2. FDISK - Run FDISK.COM to partition the drive.
3. FORMAT - Run FORMAT.COM with the /s option to high level format the drive and install the operating system.

The jumper settings are:

Drives in System	E1	E2
* Master Drive	Installed	Not Used
Slave Drive	Not Installed	Not Used

* = Indicates Factory Setting

Matsushita EME-263MG 3 1/2 inch 1.44M Floppy Drive 25-3506 (figure 300):

This drive is for the 1500HD/2810HD/3810HD. There are no jumpers on this drive. The test points are as follows:

Head Amp	TP1
Track 00 Check	TP5
Track 00 Bias	TP6 (Shorting it to ground enables Track 00 check)
Index	Pin 2 of the floppy drive connector cable
Read Data	Pin 24 of the floppy drive connector cable
Head 0 Connect	CN1
Head 1 Connect	CN2
VCC (+5V)	CN8 Pins 1,3,5,7
Ground	CN8 Pins 13,15,17,19,21,23,25

This drive is interfaced through a soldered on flat conductor cable instead of the conventional ribbon cable.

2400 Baud Modem for the 1500HD/2810HD/3810HD 25-3525 (figure 280):

There are no jumpers for this modem. It is installed beneath the two inch wide access panel adjacent to the battery. The modem is connected to the main logic board via a single flat cable and secured in position upside down with two screws.

TANDY COMPUTER PRODUCTS

```
*****  
*                                           *  
*                                           *  
*           T A N D Y   3 0 0 0           *  
*                                           *  
*                                           *  
*****
```

Notes:

The Tandy 3000 comes in a variety of configurations.

- Tandy 3000 FD - One 1.2 MEG floppy drive, either the M4854-347 or the MF504A. May have the standard main logic or the gate array version.
- Tandy 3000 20 MEG HD - One 1.2 MEG floppy drive, either the M4854-347 or the MF504A. One internal 20 MEG hard drive, either the MR522 or the ST225. May have the standard main logic or the gate array version.
- Tandy 3000 40 MEG HD - One MF504A 1.2 MEG floppy drive, one internal 40 MEG hard drive, and the gate array version of the main logic board.

Following are the jumpers for each of the possible combinations:

Tandy 3000 Standard Main Logic Board (figure 93):

Jumper positions on the Tandy 3000 main logic board vary depending on the configuration of the machine. The positions labeled "(standard)" are the default positions from the factory.

Monitor Type

- E2-E3 Selects monochrome video board (standard)
E3-E4 Selects color video board

Memory Size

- None Selects 512K onboard memory (standard)
E13-E14 Selects 640K onboard memory

ROM Size

- E5-E9 Selects 27128 type ROMs (standard)
E7-E11 Selects 27128 type ROMs (standard)
E6-E10 Selects 27256 type ROMs
E8-E12 Selects 27256 type ROMs

TANDY COMPUTER PRODUCTS

Tandy 3000 Gate Array Main Logic Board (figure 119):

- E4-E5 Selects color video board
 E5-E6 Selects monochrome video board

On board RAM is selected with E7 through E10 as follows:

<u>E7-E8</u>	<u>E9-E10</u>	<u>RAM Size</u>
Off	On	512K
On	Off	640K
Off	Off	1 MEG

- E11-E15 & E13-E17 Selects 16K ROMs (standard)
 E12-E16 & E14-E18 Selects 32K ROMs

Floppy Disk Controller Board (figure 94):

The standard configurations are also valid if there is no jumper installed.

- E1-E2 Selects primary address 3Fx (standard)
 E2-E3 Selects secondary address 37x
 E4-E5 Enables board (standard)
 E5-E6 Disables board
 E7-E8 Selects single speed drive M4851 (standard)
 E8-E9 Selects dual speed drive M4854
 E14-E15 Indicates 24 MHz crystal is being used (standard)
 E13-E14 Indicates 24 MHz oscillator is being used

Floppy/Hard Drive WD1002-WA2 Controller Board (figure 95):

- E2-E3 Selects primary address for floppy (standard)
 E1-E2 Selects secondary address for floppy
 E5-E6 Selects primary address for hard drive (standard)
 E4-E5 Selects secondary address for hard drive
 E7-E8 Connects floppy read data into VCO

Floppy/Hard Drive WD1003-WA2 Controller Board (figure 124):

- E2-E3 Selects primary address for floppy (standard)
 E1-E2 Selects secondary address for floppy
 E5-E6 Selects primary address for hard drive (standard)
 E4-E5 Selects secondary address for hard drive
 E7-E8 Supports 360 RPM floppy disk drives (standard)
 E8-E9 Supports 300 RPM floppy disk drives

TANDY COMPUTER PRODUCTS

Mitsubishi M4854-347 1.2 MEG Floppy Drive Logic Board (figure 97):

DS1 Both floppy drives in system use DS1 as the cable selects the drive
 TD Termination select
 HC Selects constant head load
 UD Disables head unload delay
 DC Selects active low diskette change
 MM Spindle motor power controlled by 'MOTOR ON' signal
 RR Output selected by 'DRIVE SELECT' signal
 SB Selects 360 rpm for both high and low density modes
 1IH LED will light with the 'DRIVE SELECT' signal

Mitsubishi MF504A 1.2 MEG Floppy Drive Logic Board (figure 109):

DS1 Both floppy drives in sysem use DS1 as the cable selects the drive
 TD Connect drive select terminator
 DC Diskette change, connects active signal when drive door opened
 MM Spindle motor power controlled by 'MOTOR ON' signal
 RR Output selected by 'DRIVE SELECT' signal
 SB Selects 360 rpm for both high and low density modes

20 MEG Mitsubishi (MR522) Hard Drive Logic Board (figure 100):

Switch	First Drive	Second Drive	Description
SW1-1	On	On	Selects daisy chain operation
SW1-2	Off	Off	Disables diagnostic operation
SW1-3	Off	Off	Drive select 4
SW1-4	Off	Off	Drive select 3
SW1-5	Off	On	Drive select 2
SW1-6	On	Off	Drive select 1
SW2-1	On	Off	Termination
SW2-2	On	Off	Termination
SW2-3	On	Off	Termination
SW2-4	On	Off	Termination
SW2-5	On	Off	Termination
SW2-6	On	Off	Termination

20 MEG Seagate (ST225) Hard Drive Logic Board (figure 101):

Only one jumper should be on.

15-16 Drive select 1
 13-14 Drive select 2
 11-12 Drive select 3
 9-10 Drive select 4

Termination resistor pak (220/330 ohm) should be installed on the last drive on the cable.

TANDY COMPUTER PRODUCTS

40 MEG CDC (WREN II) Hard Drive Logic Board (figure 110):

DSx Drive select (DS1 = C, DS2 = D)

Termination resistor pak (220/330 ohm SIP) should be installed on the last drive on the cable.

Serial/Parallel Board Revision "A" 25-4034 (figure 102):

There are new ways of configuring LPT port addresses and assignments which will affect the jumpering configurations of boards related to parallel ports.

REFER TO TECHNICAL BULLETIN INFO:26 FOR FURTHER DETAILS ON CONFIGURING THIS BOARD WITH THE 25-3049 MONOCHROME PARALLEL BOARD TOGETHER OR THE NEWER COMPUTERS (i.e., 4020/25/33LX series).

E1-E3 Selects USA Standard baud-rate generator (standard)

E1-E2 & Selects International baud-rate

E3-E4 Selects International baud-rate

E6-E7 Selects parallel port 1 (LPT1) address 378-37F (standard)

E5-E6 Selects parallel port 2 (LPT2) address 278-27F

E9-E10 Selects serial port 1 (COM1) address 3F8-3FF (standard)

E8-E9 Selects serial port 2 (COM2) address 2F8-2FF

Serial/Parallel Board Revision "B" and "C" 25-4034 (figure 115):

There are new ways of configuring LPT port addresses and assignments which will affect the jumpering configurations of boards related to parallel ports.

REFER TO TECHNICAL BULLETIN INFO:26 FOR FURTHER DETAILS ON CONFIGURING THIS BOARD WITH THE 25-3049 MONOCHROME PARALLEL BOARD TOGETHER OR THE NEWER COMPUTERS (i.e., 4020/25/33LX series).

E1-E3 Selects USA Standard baud-rate generator (standard)

E1-E2 & Selects International baud-rate

E3-E4 Selects International baud-rate

PORT SELECTION

<u>LPT1</u>	
E6-E7	Selects address 378-37F
E11-E12	Enables IRQ7

<u>LPT2</u>	
E5-E6	Selects address 278-27F
E13-E14	Enables IRQ5

<u>COM1</u>	
E9-E10	Selects address 3F8-3FF
E15-E16	Enables IRQ4

<u>COM2</u>	
E8-E9	Selects address 2F8-2FF
E17-E18	Enables IRQ3

This page intentionally left blank.

TANDY COMPUTER PRODUCTS

```
*****  
*                                                                 *  
*                                                                 *  
*           T A N D Y   3 0 0 0 / 1 2 M H Z           *  
*                                                                 *  
*                                                                 *  
*****
```

TANDY COMPUTER PRODUCTS

RAM Specifications:

Organization	Access Time
256K X 1	120nsec
64K X 4	120nsec
64K X 1	120nsec

Tandy 3000 12MHZ Main Logic Board (figure 137):

Monitor Type

E1-E2	Selects Color Video Board
E2-E3	Selects Monochrome Video Board

Processor Clock Speed

E9-E10	Selects 6MHZ Processor Clock Speed
E10-E11	Selects 12MHZ Processor Clock Speed
E9-E10-E11	Off: Allows Processor Clock Speed to be software selectable. Default Clock Speed is 12MHZ (Standard)

Co-processor Clock Speed

E43-E44 and E47-E48	6MHZ (5.3MHZ effective operation)
E44-E45 and E48-E49	8MHZ
E44-E46 and E47-E48	10MHZ (8MHZ effective operation)
E44-E45 and E48-E49	10MHZ with 10 MHZ crystal in Y2A. (10MHZ effective operation)

On board RAM is selected with E12 through E15 as follows:

<u>E12-E13</u>	<u>E14-E15</u>	<u>RAM Size</u>
On	On	256K
On	Off	512K (Standard)
Off	On	640K

Rom Size

E31-E32 and E40-E41	512K
E31-E32 and E41-E42	256K
E32-E33 and E41-E42	128K (Standard)

8 bit Wait States

E28-E29	On: 2 Wait States
E29-E30	On: 3 Wait States (Standard)
E28-E29-E30	Off: 4 Wait States

(continued on next page)

TANDY COMPUTER PRODUCTS

Serial Port

E20-E21 Enables on board Serial Port
 E26-E27 On: Selects COM1 (Standard)
 Off: Selects COM2
 E34-E35 On: IRQ4 selected (Standard)
 E35-E36 On: IRQ3 selected
 E34-E35-E36 Off: Disables on board interrupts for Serial Port

Parallel Port

E18-E19 Enables on board Parallel Printer Port
 E24-E25 On: Selects LPT1 (Standard)
 Off: Selects LPT2
 E38-E39 On: IRQ7 selected (Standard)
 E37-E38 On: IRQ5 selected
 E37-E38-E39 Off: Disables on board interrupt for Parallel Port

FDC/DMA

E4-E5 Selects 6MHZ DMA clock
 E7-E8 Off: Sets Precomp to 120nsec (Standard)
 On: Sets Precomp to 187nsec
 E16-E17 Enables on board FDC (Standard)
 E22-E23 On: Selects on board FDC as primary address. (Standard)
 Off: Selects on board FDC as secondary address.

Mitsubishi M4854-347 1.2 MEG Drive Logic Board (figure 97):

DS1 Both floppy drives in system use DS1 as the cable selects the drive
 TD Termination select
 HC Selects constant head load
 UD Disables head unload delay
 DC Selects active low diskette change
 MM Spindle motor power controlled by 'MOTOR ON' signal
 RR Output selected by 'DRIVE SELECT' signal
 SB Selects 360 RPM for both high and low density modes
 1IH LED will light with the 'DRIVE SELECT' signal
 The terminating resistor pak should be installed in the last drive on the cable.

WD1002-WA2 Floppy/Hard Drive Controller Board (figure 95):

E2-E3 Selects primary address for floppy (standard)
 E1-E2 Selects secondary address for floppy
 E5-E6 Selects primary address for hard drive (standard)
 E4-E5 Selects secondary address for hard drive
 E7-E8 Connects floppy read data into VCO

NOTE: Proper system configuration when this board is installed in the Tandy 3000 12MHZ computer.

1. E22-E23 jumper on the main logic board removed, which puts the onboard floppy drive controller at the secondary address.
2. Connect the floppy drive to the Floppy/Hard Drive Controller NOT the main logic board.

TANDY COMPUTER PRODUCTS

WD1003-WA2 Floppy/Hard Drive Controller Board (figure 124):

E2-E3 Selects primary address for floppy (standard)
 E1-E2 Selects secondary address for floppy
 E5-E6 Selects primary address for hard drive (standard)
 E4-E5 Selects secondary address for hard drive
 E7-E8 Supports 360 RPM floppy disk drives (standard)
 E8-E9 Supports 300 RPM floppy disk drives

NOTE: Proper system configuration when this board is installed in the Tandy 3000 12MHZ computer.

1. E22-E23 jumper on the main logic board removed, which puts the onboard floppy drive controller at the secondary address.
2. Connect the floppy drive to the board NOT the main logic board.

Enhanced Keyboard 25-4038 (figure 129):

4 position dip switch

Computer	Position 1	Position 2	Position 3	Position 4
Tandy 3000 (AT types)	On	On	XX	XX
XX=Don't Care				

TANDY COMPUTER PRODUCTS

```
*****  
*                                                                 *  
*                                                                 *  
*           T A N D Y   3 0 0 0 H L                               *  
*                                                                 *  
*                                                                 *  
*****
```

NOTES:

The Tandy 3000HL may use any of the expansion boards for the Tandy 3000.

If an expansion board contains an FDC circuit, such as the Hard Drive/Floppy Drive controller, the main logic's on board FDC circuit should be disabled and the floppy drive cables should be routed to the expansion board.

If an expansion board contains a printer port it must be configured as LPT2 or the main logic's on board printer port must be disabled.

RAM Specifications:

Organization	Access Time
256K X 1	150nsec
64K X 4	150nsec
64K X 1	150nsec

Tandy 3000HL Main Logic Board (figure 122):

E1-E2 Selects color video board

E2-E3 Selects monochrome video board

E4-E5 Enable on board parallel port (standard)
Remove E4-E5 to disable on board parallel port.

E6-E7 Enable on board FDC port (standard)
Remove E6-E7 to disable on board FDC port.

RAM Size	E8-E9	E10-E11	
512K	On	Off	(standard)
640K	Off	On	

E12-E13 Selects 27128 (16Kx8) type ROMs (standard)

E13-E14 Selects 27256 (32Kx8) type ROMs

E16-E17 Selects 8 MHz clock for 92C32 type data separator
(for Rev. A PCB, a jumper wire from U80 pin 3 to U81 pin 13)

E15-E16 Selects 4 MHz clock for 92C16 type data separator
(for Rev. A PCB, a jumper wire from U80 pin 3 to U81 pin 9)

Important Note: The computer may come with either the 92C16 or the 92C32. Confirm the type, at location U80, to select the correct jumper position. On Rev A PCB, confirm the type at location U80, and insure the jumper wire connections are correct.

Mitsubishi MF501A Floppy Drive Logic Board (figure 108):

DS1 Both floppy drives in system use DS1 as the cable selects the drive

MM Spindle motor power controlled by 'MOTOR ON' signal

TANDY COMPUTER PRODUCTS

Tandy 3000HL Main Logic Board with Keylock (figure 139):

This logic board is the same as the original 3000HL for jumpering considerations. The only difference between the two logic boards is the addition of S2 for Keyboard Inhibit.

- E1-E2 Selects color video board
 E2-E3 Selects monochrome video board
- E4-E5 Enable on board parallel port (standard)
 Remove E4-E5 to disable on board parallel port.
- E6-E7 Enable on board FDC port (standard)
 Remove E6-E7 to disable on board FDC port.

<u>RAM Size</u>	<u>E8-E9</u>	<u>E10-E11</u>	
512K	On	Off	(standard)
640K	Off	On	

- E12-E13 Selects 27128 (16Kx8) type ROMs (standard)
 E13-E14 Selects 27256 (32Kx8) type ROMs

E16-E17 Selects 8 MHz clock for 92C32 type data separator
 (for Rev. A PCB, a jumper wire from U80 pin 3 to U81 pin 13)

E15-E16 Selects 4 MHz clock for 92C16 type data separator
 (for Rev. A PCB, a jumper wire from U80 pin 3 to U81 pin 9)

Important Note: The computer may come with either the 92C16 or the 92C32.
 Confirm the type, at location U80, to select the correct
 jumper position. On Rev A PCB, confirm the type at location
 U80, and insure the jumper wire connections are correct.

This page intentionally left blank.

```
*****  
*                                                                 *  
*                                                                 *  
*           T A N D Y   3 0 0 0 N L           *  
*                                                                 *  
*                                                                 *  
*****
```

RAM specifications

Organization	Access Time
256K x 1 SIMM	150 nS
64K x 4 DIP	150 nS
64K x 1 DIP	150 nS

Tandy 3000 NL Main Logic Board 25-4072 (figure 206):

E1-E2, E6-E7	Optional 80287-8 using on board clock for effective operation at 6.7 Mhz.
E2-E3, E4-E6	Optional 80287-10 and optional 33% duty cycle 10 Mhz oscillator for effective operation at 10 Mhz.

NOTE: When using the Rev. A MLB and a Co-processor the bus speed must be 10 Mhz.

E8-E9 SW3 = ON SW4 = ON	* On-board Serial port = IRQ4 Enabled COM1 (3F8-3FF)
E9-E10 SW3 = ON SW4 = OFF	On-board Serial port = IRQ3 Enabled COM2 (2F8-2FF)
E12-E13 SW1 = ON SW2 = ON	* On-board Parallel port = IRQ7 Enabled LPT1 (378-37F)
E11-E12 SW1 = ON SW2 = OFF	On-board Parallel port = IRQ5 Enabled LPT2 (278-27F)
E14-E15 E15-E16	* Monochrome Monitor Color Monitor

(continued on next page)

TANDY COMPUTER PRODUCTS

Memory Jumpers	Bank 0		Bank 1		Bank 2		Bank 3		Base Memory	Ext. Memory
	MBd	EXBd	MBd	EXBd	MBd	EXBd	MBd	EXBd		
E21-E22,E23-E24	*	512K	--	--	--	--	--	--	512K	0K
E21-E22,E23-E24		512K	--	128K	--	--	--	--	640K	0K
E20-E21,E24-E25		--	512K	--	512K	--	--	--	640K	384K
E21-E22,E24-E25		--	512K	128K	--	--	512K	--	512K	1024K
E20-E21,E24-E25		--	512K	--	512K	--	512K	--	512K	1024K
E21-E22,E24-E25		--	512K	128K	--	--	2M	--	2M	4096K
E20-E21,E24-E25		--	512K	--	512K	--	2M	--	2M	4096K
E20-E21,E24-E25		--	2M	--	2M	--	2M	--	2M	7168K

A bank marked with -- in the above table will not be accessed even if it contains memory.

E26-E27,E29-E31 * 128K BIOS ROMs (16K x 8)
 E26-E27,E28-E29 256K BIOS ROMs (32K x 8)
 E27-E30,E28-E29 512K BIOS ROMs (64K x 8)

SW1 - * On = On-board Parallel port enabled
 Off = On-board Parallel port disabled

SW2 - * On = On-board Parallel port = LPT1 = 378H ** See NOTE on page 4 **
 Off = On-board Parallel port = LPT2 = 278H

SW3 - * On = On-board Serial port enabled
 Off = On-board Serial port disabled

SW4 - * On = On-board Serial port = COM1
 Off = On-board Serial port = COM2

SW5 - * On = On-board Floppy = Primary FDC
 Off = On-board Floppy = Secondary FDC

SW6 - Reserved for future options

SW7 - Reserved for future options

SW8 - Reserved for future options

Note: * denotes factory setting

*** NOTE ***

There are new ways of configuring LPT port addresses and assignments which will affect the jumpering configurations of boards related to parallel ports. REFER TO TECHNICAL BULLETIN INFO:26 FOR FURTHER DETAILS ON CONFIGURING THE 3000NL TOGETHER WITH THE MONOCHROME PARALLEL BOARD (25-3049), OR OTHER BOARDS RELATED TO PARALLEL PORTS.

TANDY COMPUTER PRODUCTS

```
*****  
*                                     *  
*                                     *  
*   T A N D Y   3 8 1  Ø  H  D   *  
*                                     *  
*                                     *  
*****
```

INTRODUCTION:

25-3571 Tandy 3810HD

The 3810HD contains an 80386SX microprocessor running at 20MHz. The computer comes standard with 1MB of RAM, expandable to 5MB on the main logic board. The video is a VGA compatible LCD display with a fluorescent backlight. A special "resume" function allows you to turn off your computer in the middle of an application without losing your place within the program. The standard configuration is:

- * 20MHz 80386SX CPU
- * Optional 80387SX Co-processor Socket
- * One Conner CP-2064 2.8 Inch 60MB Hard Disk Drive
- * One Matsushita EME-263MG 3.5 Inch 1.44MB Floppy Disk Drive
- * MSDOS Version 5.00 Operating System
- * Deskmate Version 3.05.02
- * BIOS ROM Version 3.10.01
- * Advanced Video BIOS ROM Version 1.10.00
- * VGA Compatible LCD Display with Fluorescent backlight
- * One DB-15 External VGA Port
- * One DB-25 Parallel Port / External Floppy Drive Port
- * One DB-9 RS-232 Serial Port
- * 84 Key Keyboard (Full 101 Key Emulation)
- * External PS/2 Keyboard Port
- * Resume Function
- * One 12VDC 1.4AH Ni-Cad Rechargeable Battery
- * 1MB Onboard Memory
- * Maximum Memory Expansion 5MB
- * One 16VDC 1.25A AC Adapter

Setup for the 3810 is run from the program SETUP381.COM.

MAIN LOGIC BOARD (figure 274):

This unit contains 1 jumper (JP31) that comes unjumpered. This jumper is a factory test jumper and should not be installed.

MEMORY CONFIGURATIONS:

The 3810HD comes standard with 1MB of RAM on the main logic board. Supported RAM configurations are 1MB, 3MB, or 5MB. Upgrades are done by adding double-sided 1MB 80ns SIMM modules (25-3507 figure 278). Two 25-3507 memory kits are needed for the upgrade to 3MB and four are needed for the upgrade to 5MB. The SIMM module sockets are located under a cover between the LCD display and the keyboard. Sockets CN1 and CN2 are used for the 3MB upgrade and sockets CN1, CN2, CN3, and CN4 are used for the 5MB upgrade. There are NO jumpers to set when memory is added.

TANDY COMPUTER PRODUCTS

POWER SUPPLY:

Power for the unit can be obtained from either a 12VDC 1.4AH Ni-Cad rechargeable battery (25-3526) or a 16VDC 1.25A AC adapter (WE-Ø157, 25-3571).

The Ni-Cad battery (25-3526) has a 2 to 4 hour charge time. The battery can run up to 3.1 hours under optimal conditions of continuous computing power. **The battery pack must be fully charged before using the computer.** Failure to fully charge the battery before use could greatly reduce the battery life and efficiency.

The AC adapter (WE-Ø157) has a 16VDC output and uses a positive center conductor and a negative outer conductor jack.

KEYBOARD:

The keyboard is an 84 key keyboard that supports a 1Ø1 key emulation. The "CTRL" and "CAPS LOCK" keys have the ability to have their functions reversed and the keycaps may be swapped to reflect their new functions. This is done by changing the position of a dip switch (SW2) that lies in a compartment under the battery. The switch settings are:

On - to reverse the "CTRL" and "CAPS LOCK" keys
 Default > Off - to restore the standard "CTRL" and "CAPS LOCK" keys.

The external keyboard port supports a PS/2 style enhanced keyboard.

Conner CP-2Ø64 6Ø Meg IDE Hard Drive (figure 283):

The 381Ø contains a 6ØMB 2.8" Conner CP-2Ø64 hard disk drive. The 381Ø hard drive is preinitialized at the factory with MS-DOS and DeskMate, reinitialization if needed is done in three steps:

1. HSECT - Run HSECT.COM to low level format the drive. The hard disk type is 19, the drive's translation mode circuitry will emulate a drive with 566 cylinders and 13 heads.
2. FDISK - Run FDISK.COM to partition the drive.
3. FORMAT - Run FORMAT.COM with the /s option to high level format the drive and install the operating system.

The jumper settings are:

Drives in System	E1	E2
* Master Drive	Installed	Not Used
Slave Drive	Not Installed	Not Used

* = Indicates Factory Setting

Matsushita EME-263MG 3 1/2 inch 1.44M Floppy Drive 25-3506 (figure 300):

This drive is for the 1500HD/2810/3810HD. There are no jumpers on this drive. The test points are as follows:

Head Amp	TP1
Track 00 Check	TP5
Track 00 Bias	TP6 (Shorting it to ground enables Track 00 check)
Index	Pin 2 of the floppy drive connector cable
Read Data	Pin 24 of the floppy drive connector cable
Head 0 Connect	CN1
Head 1 Connect	CN2
VCC (+5V)	CN8 Pins 1,3,5,7
Ground	CN8 Pins 13,15,17,19,21,23,25

This drive is interfaced through a soldered on flat conductor cable instead of the conventional ribbon cable.

2400 Baud Modem for the 1500HD/2810/3810HD 25-3525 (figure 280):

There are no jumpers for this modem. It is installed beneath the two inch wide access panel adjacent to the battery. The modem is connected to the main logic board via a single flat cable and secured in position upside down with two screws.

Note: Xenix and Unix are not supported on this unit.

```
*****  
*                                                                 *  
*                                                                 *  
*           T A N D Y   4 0 0 0 / A           *  
*                                                                 *  
*                                                                 *  
*****
```

TANDY COMPUTER PRODUCTS

RAM Specifications:

Organization	Access Time
256K X 9 SIMM	100nsec
1M X 9 SIMM	100nsec

Tandy 4000 Main Logic Board (figure 138):

E1-E2	On: Selects color video board Off: Selects monochrome video board
E3-E4	Connects AF32* to 82C306. NOT USED.
E5-E6	Enables primary address for onboard FDC (Standard)
E6-E7	Enables secondary address for onboard FDC
E8-E9	On: Coprocessor installed Off: No coprocessor installed

Tandy 4000A Main Logic Board (figure 207): **Same as Tandy 4000LX**

The main difference between TANDY 4000 and the TANDY 4000A is that support of the 80387 was added to the TANDY 4000A, and the 40 pin 80287 coprocessor socket was removed. Also, the jumper to enable/disable the coprocessor is different. Refer to the notes for each individual board for correct jumper settings. The 80387 math coprocessor (Catalog # 900-2131) is available through Express Order Hardware. It is not supported in a TANDY 4000 but is supported in a TANDY 4000A. It will work in the Tandy 4000 Revision C (or later) board **ONLY** and is installed in an 84 pin Weitec PGA socket at location U15. Some Revision A-1 boards will have this PGA socket as well as a 40 pin socket at location U25 for the 80287 math coprocessor. If the board has this 40 pin 80287 math coprocessor socket, then the 80387 will not function at all. All Tandy 4000As should not have this 80287 math coprocessor socket.

Jumpers are as follows:

E1 - E2	OFF for monochrome mode ON for color mode
E3 - E4	OFF for coprocessor when 80387 not installed or Wytec installed ON for 80387 coprocessor installed
E5 - E6	ON sets primary address for on board floppy controller
E6 - E7	ON sets secondary address for on board floppy controller

Sony MP-F73W-01D 3 1/2 inch 1.44 Meg Floppy Drive (figure 141):

DS1 ALL Drives Slide Switch on back right corner set to second closest position to the rear of the drive.

Termination is internal to the drive.

TANDY COMPUTER PRODUCTS

Enhanced Keyboard 25-4038 (figure 129):

4 position dip switch

Computer	Position 1	Position 2	Position 3	Position 4
Tandy 4000 (AT Types)	On	On	XX	XX
XX=Don't Care				

WD1002-WA2 Floppy/Hard Drive Controller Board (figure 95):

E2-E3 Selects primary address for floppy (standard)
 E1-E2 Selects secondary address for floppy
 E5-E6 Selects primary address for hard drive (standard)
 E4-E5 Selects secondary address for hard drive
 E7-E8 Connects floppy read data into VCO

NOTE: Proper system configuration when this board is installed in the Tandy 4000 computer.

1. E5-E6 jumper on the main logic board moved to E6-E7 jumper position which puts the onboard floppy drive controller at the secondary address.
2. Connect the floppy drive to the floppy/hard drive controller NOT the main logic board.

WD1003-WA2 Floppy/Hard Drive Controller Board (figure 124):

E2-E3 Selects primary address for floppy (standard)
 E1-E2 Selects secondary address for floppy
 E5-E6 Selects primary address for hard drive (standard)
 E4-E5 Selects secondary address for hard drive
 E7-E8 Supports 360 RPM floppy disk drives (standard)
 E8-E9 Supports 300 RPM floppy disk drives

NOTE: Proper system configuration when this board is installed in the Tandy 4000 computer.

1. E5-E6 jumper on the main logic board moved to E6-E7 jumper position which puts the onboard floppy drive controller at the secondary address.
2. Connect the floppy drive to the floppy/hard drive controller, NOT the main logic board.

This page intentionally left blank.

TANDY COMPUTER PRODUCTS

```
*****  
*                                                                 *  
*                                                                 *  
*           T A N D Y   4 Ø Ø Ø L X           *  
*                                                                 *  
*                                                                 *  
*****
```

TANDY COMPUTER PRODUCTS

Tandy 4000LX Main Logic Board 25-5100 Revision C, C-1 (figure 207):

The Tandy 4000LX comes equipped with 2 MB of RAM consisting of eight 256K x 9 80nS SIMM memory modules. These SIMMs must be rated at 80nS access time to prevent the need for wait states when accessing memory. Expansion to 8 MB of RAM is possible on the main logic board by replacing the 256K x 9 80nS SIMMs with 1 MB x 9 80nS SIMMs.

The BIOS ROM consists of two 128K ROMs. The capability exists for the use of 256K ROMs. BIOS is organized as even and odd addresses with even address information contained in U26 and odd address information contained in U32.

RAM Specifications

Organization	Access time
256K x 9 SIMM	80 nS
1M x 9 SIMM	80 nS

Tandy 4000LX Main Logic Board Jumpers

E1 - E2 OFF for monochrome mode
ON for color mode (standard)

E3 - E4 OFF for coprocessor when 80387 not installed or Weitec installed
(standard)

ON for 80387 coprocessor installed

E5 - E6 ON sets primary address for on board floppy controller (standard)

E6 - E7 ON sets secondary address for on board floppy controller

Sony MP-F73W-01D 3 1/2 inch 1.44 Meg Floppy Drive (figure 141):

DS1 ALL Drives Slide Switch on back right corner set to second closest position to the rear of the drive.

Termination is internal to the drive.

TANDY COMPUTER PRODUCTS

WD1002-WA2 Floppy/Hard Drive Controller Board (figure 95):

E2-E3 Selects primary address for floppy (standard)
E1-E2 Selects secondary address for floppy
E5-E6 Selects primary address for hard drive (standard)
E4-E5 Selects secondary address for hard drive
E7-E8 Connects floppy read data into VCO

NOTE: Proper system configuration when this board is installed in the Tandy 4000LX computer.

1. E5-E6 jumper on the main logic board moved to E6-E7 jumper position puts the onboard floppy drive controller at the secondary address.
2. Connect the floppy drive to the floppy/hard drive controller NOT the main logic board.

WD1003-WA2 Floppy/Hard Drive Controller Board (figure 124):

E2-E3 Selects primary address for floppy (standard)
E1-E2 Selects secondary address for floppy
E5-E6 Selects primary address for hard drive (standard)
E4-E5 Selects secondary address for hard drive
E7-E8 Supports 360 RPM floppy disk drives (standard)
E8-E9 Supports 300 RPM floppy disk drives

NOTE: Proper system configuration when this board is installed in the Tandy 4000LX computer.

1. E5-E6 jumper on the main logic board moved to E6-E7 jumper position puts the onboard floppy drive controller at the secondary address.
2. Connect the floppy drive to the floppy/hard drive controller NOT the main logic board.

This page intentionally left blank.

TANDY COMPUTER PRODUCTS

```
*****  
*                                                                 *  
*                                                                 *  
*           T A N D Y   4 0 0 0 S X           *  
*                                                                 *  
*                                                                 *  
*****
```

TANDY COMPUTER PRODUCTS

Tandy 4000SX 25-4900 (figure 214):

The Tandy 4000SX is an AT compatible desktop computer, based on the Intel 80386SX microprocessor, several Chips and Technologies support LSI's, an Intel FDC capable of supporting the 1.44 MEG, 720K, 1.2 MEG, and 360K floppy drives, and an AT-style IDE (Intelligent Drive Electronics) hard drive interface. Additionally, there is on-board support for serial and parallel I/O. In the standard configuration, the machine comes equipped with:

- o 16 MHz 80386SX CPU
- o socket for optional 16 MHz 80387SX numeric coprocessor
- o two proprietary local memory expansion slots, allowing expansion up to 16 MEG
- o 1 MEG of 256K x 9 bit, 100 nsec SIMM memory on a local memory adapter board (installed in one of the above proprietary memory expansion slots)
- o five 16-bit AT-style expansion card slots (expansion bus runs at 8 MHz)
- o one serial port (on main logic board)
- o one bidirectional parallel port (on main logic board)
- o enhanced AT-style 101-key keyboard
- o one 1.44 MEG floppy drive
- o three drive expansion slots, one for 3.5 inch drives, two for 5.25 inch drives (half-height devices)
- o on board floppy drive controller
- o on board real time clock and CMOS RAM with battery backup
- o on board AT-style IDE hard drive interface
- o 200 watt power supply

No system memory is installed on the main logic board; instead, all system RAM is installed on memory boards which are installed in the special memory expansion slots, leaving the AT-style expansion slots available for other options.

Main Logic Board:

The main logic board contains everything necessary for system operation save for system RAM and video display. The 80386SX CPU, optional 80387SX numeric coprocessor, serial interface, parallel interface, floppy drive controller, keyboard control, IDE hard drive interface, and clock logic is resident on this board.

Main Logic Board Jumpers and Switch Settings:

Note that the standard or default system settings are noted with two bold asterisks (*i.e.* **).

Video Monitor Type:

Monochrome video: E8-E9
Color video: E9-E10 **

BIOS ROM Type:

128K (16K x 8): E17-E18, E21-E22 **
256K (32K x 8): E17-E18, E22-E23
512K (64K x 8): E18-E19, E22-E23

Second Memory Expansion Adapter Access:

Second adapter enabled: E29-E30, E31-E32
Second adapter disabled: E30-E31, E32-E33 **

On-board Parallel Port:

Parallel port enabled: SW1 on **
Parallel port disabled: SW1 off
Address port as LPT1: SW2 on **
Address port as LPT2: SW2 off
Parallel port uses IRQ7: E12-E13 **
Parallel port uses IRQ5: E11-E12

On-board Serial Port:

Serial port enabled: SW3 on **
Serial port disabled: SW3 off
Address port as COM1: SW4 on **
Address port as COM2: SW4 off
Serial port uses IRQ4: E15-E16 **
Serial port uses IRQ3: E14-E15

(continued on next page)

TANDY COMPUTER PRODUCTS

On-board FDC:

FDC enabled: SW5 on **
 FDC disabled: SW5 off

NOTE: As per Technical Bulletin 4000SX:3 SW5 is redefined. The new definitions for SW5 are as follows:

Uni-directional on board parallel port SW5 on
 (OS/2 and Xenix compatible)
 Fully bi-directional on board parallel port SW5 off **
 (MS/DOS applications which require such operation)

Addressed at primary port: SW6 on **
 Addressed at secondary port: SW6 off

On-board IDE Hard Drive Interface:

IDE interface enabled: SW7 on **
 IDE interface disabled: SW7 off
 Addressed at primary port: SW8 on **
 Addressed at secondary port: SW8 off
 Standard IRQ14: E6-E7 **
 Non-standard IRQ14: E5-E6
 Standard IOCHRDY: E3-E4 **
 Non-standard IOCHRDY: E1-E2

80387SX Numeric Coprocessor Option:

80387SX installed: E27-E28
 80387SX not installed: E26-E27 **

Optional Dual Oscillator Option

16.0 MHz Standard Oscillator E20-E24 ** (hard wired on the board)
 32.0 MHz Oscillator Option E24-E25 (must cut trace at E20-E24)

Memory Configurations:

Allowable memory configurations for the 4000SX are somewhat different than those allowed for the 4000 and the 4000LX. Allowable configurations in this machine are:

With one memory adapter in the system:

The main logic board should be jumpered E30-E31 and E32-E33 (for one memory adapter in the system). The memory adapter should be jumpered E1-E2. Memory may be installed as follows, where the numbers under the banks indicate the type of SIMMs to be installed in the bank. Two SIMMs are required for a bank.

TANDY COMPUTER PRODUCTS

Bank 0	Bank 1	Bank 2	Bank 3	Total Memory
256K	256K	none	none	1 MEG (standard)
256K	256K	256K	256K	2 MEG
256K	256K	1 MEG	1 MEG	5 MEG
1 MEG	1 MEG	1 MEG	1 MEG	8 MEG

NOTE: 100nS speeds are standard for these SIMMs

With two memory adapters in the system:

The main logic board should be jumpered E29-E30 and E31-E32 (two memory adapters in the system). The memory adapters should be jumpered E1-E2. Memory on the first adapter should be configured at the 8 MEG configuration; memory on the second adapter should be installed as:

Bank 0	Bank 1	Bank 2	Bank 3	Total Memory
1 MEG	1 MEG	none	none	12 MEG
1 MEG	1 MEG	1 MEG	1 MEG	16 MEG

Memory Board 25-4930 (figure 260):

The memory board is very similar to that which is used in the 3000NL. However, there is now a jumper on the board which determines whether the board is being used in a system with one or two memory board slots. Jumpering for this board is:

E1-E2 on: for use in two memory board system (Tandy 4000SX)

The board is organized into four banks (Banks 0, 1, 2, and 3) of two SIMMs each. The default configuration is Banks 0 and 1 filled with four 256K x 9 bit, 100 nsec SIMMs, giving a system default configuration of 1 MEG.

Floppy Drive (figure 141):

The floppy drive is a Sony 3.5 inch micro floppy drive, the MP-F17W-70D, capable of handling both 1.44 MEG and 720K disks, with 2 heads, 80 tracks and spinning at 300 RPM. The drive test points are:

Differential read amps:	RFA, RFB
Direction:	CN101, pin 18
Step:	CN101, pin 20
Track 0:	CN104, pin 3
Index:	CN101, pin 8
Read Data (Raw Data):	CN101, pin 30

(continued on next page)

TANDY COMPUTER PRODUCTS

Ground:	AGND
Write Protect:	WPRT
Motor On:	CN101, pin 16

The drive is internally terminated, and has only one switch, S101, used for drive selection. The DS0 position is used for the first drive, and is rearmost on the switch. The second floppy, whether 3.5 inch or 5.25 inch, is selected as DS1. Upgrade 5.25 inch floppy drives should be terminated when installed.

```
*****  
*                                                                 *  
*                                                                 *  
*          TANDY 4Ø16DX/2ØLX/25LX/33LX          *  
*                                                                 *  
*                                                                 *  
*****
```

TANDY COMPUTER PRODUCTS

Tandy 4016DX 25-5001
Tandy 4020LX 25-5120
Tandy 4025LX 25-5125
Tandy 4033LX 25-5133

Introduction:

The Tandy 4016DX, 4020LX, 4025LX, and 4033LX are Tandy's newest entries into the high-speed, AT compatible market. Besides the obvious speed advantages obtained from the faster clock speeds utilized, there is also a memory cache controller incorporated into the design of the 4020/25/33LX to execute frequently used code and data. The 4016DX does not have the memory cache controller. When the cached accesses are averaged with the non-cached accesses, the net result is virtually 0 wait states. The basic system consists of four logic boards: the CPU board, main logic board, primary memory board and VGA adapter board. The standard configuration consists of:

CPU Logic Board

- * 16, 20, 25 or 33 MHz Intel 80386 processor
- * 20, 25 or 33 MHz Intel 82385 memory cache controller with 32k of 25nS access static RAM
- * socket for optional Intel 80387 or Weitek W3167 coprocessor

Main Logic Board

- * two proprietary local memory expansion slots, allowing expansion up to 16 meg
- * 1 meg (early 4025LX/33LXs came with 2 meg) of 256k x 9, 100ns SIMM memory on a local memory adapter (installed in one of the two proprietary memory slots mentioned above)
- * six AT-style, 16-bit interface slots running at 8MHz (two of the six slots are for half length cards only)
- * 16-bit VGA adapter card (installed in one of the two half-length 16-bit interface slots) (some units are coming with a new 16 bit super VGA board capable of super VGA resolutions)
- * one 1.44 meg floppy drive
- * three expansion drive slots, one for 3.5 inch drives, two for half-height 5.25 inch drives
- * on board dual-speed floppy drive controller
- * on board AT-style IDE hard drive interface
- * one on board serial port
- * one on board bi-directional parallel port (bi-directional feature may be disabled through setup for OS/2 and Xenix compatibility)
- * enhanced AT-style 101-key keyboard with software password protection (uses PS/2 style connector)
- * real time clock with battery backup
- * on board PS/2 style mouse port (COMM port is not used)
- * 200 watt power supply
- * keylock on front face locks the top case to the frame and does not affect the keyboard.

CPU Logic Board (figures 237 and 238):

The CPU logic board plugs into the main logic board at connector J2. The 4020/25/33LX CPU logic boards (figure 238) use memory caching which allows the CPU quick access to frequently used code and data. The 4016DX CPU logic board (figure 237) does not use memory cache control. The areas of memory that are not to be cached are selectable through the MEMCACHE.COM program on the Utilities diskette. The default areas not to be cached are from 640k - start of BIOS (A0000-F7FFF), and from 15meg to the end of 16meg (E00000-FFFFFF).

Main Logic Board Revisions A-C (figure 236):

The main logic board is very similar in architecture to the 4000LX. It uses the Chips and Technologies seven-piece CHIPset and 82C206, which is used in the 4000LX. The major difference is that the 4000LX has a place for up to 8-1meg SIMM modules on the main logic board and the 4016DX/4020/25/33LX series have all the system RAM located on separate 32-bit memory boards plugged into the main logic board. The floppy drive controller, IDE hard drive interface, serial interface, parallel interface, PS/2 mouse interface, and clock logic are resident on this board.

Main Logic Board Jumpers:

Note: * denotes default settings

Primary Monitor Type:

Input per setup:	E11-E12 *
Color monitor:	E10-E11
Monochrome:	no jumper

BIOS ROM Type:

128k (16k x 8):	no jumper
256k (32k x 8):	E24-E25 *
512k (64k x 8):	E22-E23 E24-E25
1meg (128k x 8):	E22-E23, E24-E25

On-Board Hard Disk (IDE) Interface:

IOCHRDY enabled:	E1-E2 jumpered *
IOCHRDY disabled:	E1-E2 removed
Diag. mode disabled:	E3-E4 removed *
Diag. mode enabled:	E3-E4 jumpered

I/O Recovery:

Enabled:	E8-E9 jumpered *
Disabled:	E8-E9 removed

(continued on next page)

TANDY COMPUTER PRODUCTS

Operating Mode:

4016DX/4020LX/25LX: E14-E15, E17-E18, E20-E21 *
 4033LX Only: E14-E15, E17-E18, E19-E20 *

Tandy 4016DX Rev D Main Logic Board 25-5001

The Revision D Main Logic Board is for the 4016DX only. It is quite different from Revisions A-C in that there are alot more jumpers on the board. Below are the jumpers.

Note: * denotes default settings

Jumpers:

IOCHRDY to IDE interface	E1-E2 jumpered *
IOCHRDY disabled	E1-E2 removed
IDE diagnostic mode enabled	E3-E4 jumpered
IDE diagnostic mode disabled	E3-E4 removed *
Delayed ADS for 486	E5-E7 jumpered
Regular ADS from CPU	E6-E7 jumpered *
Sync CPUADS to SCLK	E7-E8 jumpered
HRQ2 always enabled	E9-E10 jumpered *
Video mode set through setup	E11-E12 jumpered *
Enable color mode only	E12-E13 jumpered
Latch interrupt for 486	E14-E15 jumpered
Interrupt unaltered	E15-E16 jumpered *
Buffered M/IO	E17-E18 jumpered *
M/IO unbuffered	E17-E18 removed
LBA/AF32 signal always in	E19-E20 jumpered *
Enable buffers for 486 clock	E21-E22 jumpered
Disable buffers for 486 clock	E21-E22 removed *
Enable write F0	E23-E24 jumpered
Enable generation of 486 clock	E25-E27 jumpered
Disable generation of 486 clock	E25-E27 removed *

(continued on next page)

TANDY COMPUTER PRODUCTS

Enable terminating network	E26-E28 jumpered *
Disable terminating network	E26-E28 removed
486 CLKB	E29-E30 jumpered
Enable terminating network	E30-E39 jumpered *
Clock B-A for 386	E29-E38 jumpered
Enable terminating network	E38-E39 jumpered
CPUBUSY for 386	E31-E40 jumpered *
CLKD for 486	E31-E40 removed
NPBUSY for 386	E32-E41 jumpered *
CLKE for 486	E32-E41 removed
386 CLK2	E33-E34 jumpered *
Enable terminating network	E33-E42 jumpered
486 CLK1	E34-E43 jumpered
Enable terminating network	E43-E42 jumpered *
SYSCLK2 always in	E35-E36 jumpered *
Enable terminating network	E35-E44 jumpered
SYSCLK2/2 always out	E36-E45 jumpered
Enable termination network	E44-E45 jumpered *
CPU READY always in	E37-E46 jumpered *
27128 (16k x 8) ROM	E47-E48 removed, E49-E50 removed
27256 (32k x 8) ROM	E47-E48 removed, E49-E50 jumpered *
27512 (64k x 8) ROM	E47-E48 jumpered, E49-E50 jumpered
27010 (128k x 8) ROM	E47-E48 jumpered, E49-E50 jumpered

Memory Board (figure 201):

The (25-6030) memory boards used are the revision C version of the memory board used in the 5000MC. Revision C provides support for 4meg SIMM modules, but use of the 4meg SIMM module will not be supported on the 4016DX/4020/25/33 LX series. The two 32-bit memory board slots are located at the front of the computer and allow places for two half-length interface boards on the backside of the computer. The front of the memory boards are secured by a bracket that screws into the bottom of the computer (the bracket to secure the secondary memory board is also included in the computer). As with the rest of the 4000 line, 16meg (2 memory boards loaded with 8-1meg SIMMs) will be the maximum supported configuration. 100 nsec SIMM modules are used. There are no jumpers or switches on this board. Supported configurations include:

(continued on next page)

TANDY COMPUTER PRODUCTS

1meg	Primary memory board stuffed with 4-256k SIMMs
2meg	Primary memory board stuffed with 8-256k SIMMs
4meg	Primary memory board stuffed with 4-1meg SIMMs or 2 memory adapters each stuffed with 8-256k SIMMs
8meg	Primary memory adapter stuffed with 8-1meg SIMMs
10meg	Primary memory adapter stuffed with 8-1meg SIMMs and secondary adapter stuffed with 8-256k SIMMs
16meg	2 memory adapters each stuffed with 8-1meg SIMMs

Parallel port configuration:

In setup, the parallel port number does not represent the LPT#. This is a brief overview of the parallel port addressing scheme: Reference Technical Bulletin INFO:26 for more information.

Parallel port	I/O Address	IRQ	Description
1	3B8-3BF	7	Mono/parallel board port
2	378-37F	7	Conventional LPT1 port
3	278-27F	5	Conventional LPT2 port

The default parallel port in setup is 2, which denotes LPT1 according to the chart. Xenix 2.3.x does not recognize the ports in the same way. It sees them like this:

Parallel port	Unix/Xenix
1	/dev/lp1
2	/dev/lp0
3	/dev/lp2

16 Bit VGA Adapter Board (figure 221):

The VGA adapter board is a half-card, 16-bit adapter and is fully IBM PS/2 VGA compatible. It is software compatible with programs written for VGA, MCGA, EGA, CGA, MDA, and Hercules graphics. The different modes may be entered using the VGA.EXE program from the Utilities diskette. Following are the switches and jumpers available:

SW1	1	on	for special multi-frequency displays
		* off	conventional VGA
	2	* on	enables all VGA modes on all monitors - this allows monochrome-mapped text modes to be used on color monitors, and color "shades of grey" modes to be used on monochrome monitors
		off	monochrome-mapped modes are not available on color monitors, and color-mapped modes are not available on monochrome monitors
	3	* off	not used
	4	* on	16-bit operation with AutoSense enabled
		off	8-bit operation with AutoSense disabled
W1		* on	jumped always
W2		* 1-2	enables 132 column text mode
		2-3	supports all signals on the Video Feature Connector

Note: * denotes default setting

If a secondary adapter is to be added, it must be configured as the second adapter, for only the VGA adapter can be the primary display device. You are allowed only one color and one monochrome adapter in the computer at one time in accordance with IBM PS/2 VGA compatibility (EX. if you add a CGA adapter and a CM-11, you must configure the VGA adapter for monochrome operation). The MODE.EXE command is used to select between the two adapters.

16 Bit Super VGA Adapter Board (figure 298):

The VGA adapter board is a half-card, 16 bit adapter and is fully IBM PS/2 VGA compatible. It supports Super VGA modes with 132 column text and both 800 x 600 and 1024 x 768 resolution graphics. It comes with 512K of memory on board, and is capable of supporting both fixed frequency and multi-frequency monitors. Support for the Super VGA modes is accomplished by executing the VGA1024.EXE program from the Utilities diskette. Following are the switches and jumpers available:

SW1	1	on	for special multi-frequency displays
		* off	conventional fixed frequency displays
	2	* on	enables all VGA modes on all monitors - this allows monochrome-mapped text modes to be used on color monitors, and color "shades of grey" modes to be used on monochrome monitors
		off	monochrome-mapped modes are not available on color monitors, and color-mapped modes are not available on monochrome monitors
	3	* off	not used
	4	* on	16-bit operation with AutoSense enabled
		off	8-bit operation with AutoSense disabled
W1		* on	enables normal operation using AutoSense
			Jumped always

Note: * denotes default setting

Sony MP-17W-70D 3.5" 1.44 Meg Floppy Drive (figure 141):

The floppy drive is a Sony 3.5 inch unit, the MP-17W-70D, which is the same unit used in the 4000SX. It has a formatted capacity of 1.44 megabytes on an 80 track, double sided, 3.5" diskette. The drive test points are:

Differential read amps:	RFA, RFB
Direction:	CN101, pin 18
Step:	CN101, pin 20
Track 0:	TRK0
Index:	CN101, pin 8
Read data:	CN101, pin 30
Ground:	AGND
Write protect:	WPRT
Motor on:	CN101, pin 16

The drive is internally terminated, and has only one switch, S101, used for drive selection. The DS0 position is used for the first drive, and is rearmost on the switch. The second floppy, whether 3.5" or 5.25", is selected as DS1. Upgrade 5.25" floppy drives should be terminated when installed.

Hard Drive:

Several options for hard disk storage exist. Support for AT-style IDE drives is available through connector J8 of the main logic board. Other possible options include optional SCSI, ESDI, ST-506 type (AT-style), and Hard Card hard drives. All hard drive types except the hard cards must be defined in the setup. The possible combinations of hard drives that can co-exist together are SCSI and either ESDI, IDE, or ST-506. Tandy no longer markets conventional AT-style ST-506 type hard drives but they are supported. A secondary IDE drive may be mounted in one of the 5.25" slots by using an adapter available as AXX-7004, 25-4159.

Note: The IDE drives, like the SCSI drives, are already low-level formatted. Do not HSECT these drives!

Further Notes:

- * The PS/2 mouse functions properly under the Tandy version of OS/2 but not with the IBM version of OS/2.
- * The parallel ports are specified differently than previous units, please read parallel port section carefully.
- * SCO version 2.3.2 or greater must be used since it supports VGA; SCO Xenix 2.2.4 does not support VGA video.
- * The network password mentioned in user's manual was not implemented.
- * 25-4069 40M internal tape drive is not supported on these units.

This page intentionally left blank.

TANDY COMPUTER PRODUCTS

```
*****  
*                                                                 *  
*                                                                 *  
*           T A N D Y   4 Ø 1 6 S X                             *  
*                                                                 *  
*                                                                 *  
*****
```

TANDY COMPUTER PRODUCTS

Tandy 4016SX 25-4901 (figure 239):

The Tandy 4016SX is the replacement for the Tandy 4000SX. It is one of a series of low profile computers. This machine utilizes an 80386SX microprocessor, Chips and Technologies support LSIs, a FDC controller, a 16 bit VGA controller, and an AT-style IDE hard drive interface all on the main logic board. The unit stands only 4.5 inches high. Standard equipment includes:

- * 16 MHz 80386SX CPU.
- * Socket for an optional 80387SX coprocessor.
- * 1 Meg. of RAM (four 256Kx9 100nS SIMMs).
- * Capable of up to 4 Meg. of RAM on board total.
- * Three 16 bit AT compatible expansion slots.
- * 16 bit VGA graphics adapter built in.
- * One 1.44 Meg. 3.5 inch diskette drive.
- * Expansion slots for one more 3.5" drive and one half height 5.25" drive.
- * On board dual speed floppy controller supports 2 drives.
- * On board AT-style IDE hard drive interface.
- * On board serial port.
- * On board parallel printer port.
- * Enhanced PS/2 style 101-key keyboard.
- * PS/2 style mouse interface.
- * 100 watt power supply.
- * Carriage style chassis for easy subassembly access.

Main Logic Board

The main logic board contains all the circuitry necessary for system operation. System memory is installed on the main logic board. There are four SIMM sockets for this purpose. Using 1 Meg. SIMMs limits system memory to 4 Meg. on board. The actual supported steps are: 1 Meg. (4, 256Kx9), 2 Meg. (2, 1Mx9), and 4 Meg. (4, 1Mx9). Using 16 bit expansion boards the system could be brought up to a maximum of 16 Meg. The video adapter, FDC, keyboard interface, mouse interface, serial port, printer port, AT-style IDE interface, and clock logic are all on this PCB.

Switches:

S1-1	Parallel Port Enable
S1-2	Parallel Port Address
S1-3	Serial Port Enable
S1-4	Serial Port Address
S1-5	Parallel Port Bidirectional
S1-6	FDC Address
S1-7	IDE Enable
S1-8	IDE Port Address

Factory Setting:

On = enabled	Off = disabled
On = LPT1 = 3BCH	Off = LPT2 = 378H
On = enabled	Off = disabled
On = COM1	Off = COM2
On = no	Off = yes
On = primary	Off = secondary
On = enabled	Off = disabled
On = primary	Off = secondary

TANDY COMPUTER PRODUCTS

Jumpers:

E1,2,3,4,5,6	BIOS ROM SIZE	E2-E3 and E5-E6, 27C128 (2) E1-E2 and E5-E6, 27C256 (2) (default) E1-E2 and E4-E5, 27C512 (2)
E7,8,9	Color/Monochrome	E7-E8 Color (default) E8-E9 Monochrome
E14,16,18	Serial Port Int.**	E14-E16 COM1 IRQ4 (default) E16-E18 COM2 IRQ3
E19,20,21	Parallel Port Int.	E20-E21 LPT1 IRQ7 (default) E19-E20 LPT2 IRQ5
E25,26,27	On Board Video Int.*	E25-E26 disabled (default) E26-E27 enabled
E30,31,32	Coprocessor	E30-E31 installed E31-E32 not installed (default)
E33,34,35	On Board Video Enable	E33-E34 enabled (default) E34-E35 disabled

* NOTE: The video interrupt should normally be disabled when using the on board video capability. This is IRQ9 which has been software mapped to IRQ2 per the AT standard.

** NOTE: The silk screened legends on Rev. B1 PCBs for these jumpers are WRONG. Those listed here and in the users manual are correct.

FLOPPY DRIVES (figure 141):

The floppy drive is a Sony MP-17W-70D. This is the same 3.5 inch, 1.44 Meg. drive found in the 4000SX, 4020LX, and 4025LX. Here are the drive's test points:

Differential read amps:	RFA, RFB
Step:	CN101, pin 20
Track 0:	TRK0
Index:	CN101, pin 8
Raw data:	CN101, pin 8
Ground:	AGND
Write protect:	WPRT

The drive is internally terminated. There is a single drive select switch on the side. Drive A: should be set for DS0, a second drive (B:) DS1, etc. If a 5.25" drive is added it should be terminated.

Hard drives:

There are several hard drive options available for the 4016SX. Hard Cards are NOT supported. SCSI, ST-506, ESDI, and AT-style IDE drives will work with the unit. The physical size of the hard drive can be a limitation. Two types of hard drives can be mounted. The 5.25" drive bay or the 3.5" bays can be used. When using the 5.25" mount, a standard half height hard drive is allowed. When using a 3.5" drive in the 3.5" bays, use 1" tall hard drives. Remember, SCSI and IDE drives are already low level formatted. Do not run HSECT on these drives.

The Utility Diskette

The 4016SX has its own utilities diskette similar to that used by the 4020LX and 4025LX. TEMMS16.EXE is the expanded memory manager driver included with this unit. TEMMS16.EXE allows you to use up to 4 Meg. of RAM as LIM 4.0 expanded memory. Be careful, however, when setting up the TEMMS16 parameters "I" and "M". The "I" parameter identifies the port address used by TEMMS16. It should not be set to an address currently used by an adapter card. The "M" parameter sets the frame address in memory. Do not set the frame address such that it would overlap memory used on adapter cards (like a SCSI controller).

Service Notes:

The expansion backplane can be removed by removing two screws holding the backplane bracket to the chassis. One of these screws is at the rear, just above the keyboard connector. The other screw is at the front of the chassis.

There is no -5 Volts circuit on the main logic board. The -5 Volts is derived from the -12 Volts with the help of a -5 Volt regulator mounted on the expansion backplane. This means that a 2400 Baud modem plugged directly into the main logic board would not work (no -5V). The modem would have to be inserted into the expansion backplane (which has -5V).

When reassembling the unit, watch your cable dress! The carriage could easily crimp cables or trap unused connectors against the main logic (warping it).

When closing the carriage KEEP YOUR FINGERS OUT OF THE WAY. As the drive carriage moves into its resting place, the end closest to the expansion backplane passes by the front grill with a shearing action. The edges are SHARP! Later models will have dulled edges, but still be careful.

```
*****  
*                                     *  
*                                     *  
*   T A N D Y   4 Ø 2 Ø S X   *  
*                                     *  
*                                     *  
*****
```

TANDY COMPUTER PRODUCTS**INTRODUCTION:**

The 4020SX utilizes an 80386SX 32-bit microprocessor running at 20Mhz. The computer comes with 2MB of RAM (25-4902) or 1 MB of RAM (25-4903), both expandable to 5MB on the main logic board. One Megabyte of this RAM is soldered to the main logic board, the other Megabyte is installed on four 256K 80ns SIMM sockets. The video circuit is one of the biggest advantages of this computer. Contained on the main logic board is 256K of video RAM, that can be expanded to 512K. This extra RAM for the video circuit allows the use of multi-frequency monitors and additional VGA graphic modes. The 4020SX comes standard with:

- * 20Mhz 80386SX CPU
- * Socket for optional 80387SX co-processor
- * BIOS ROM version 01.10.00
- * 2MB of RAM expandable up to 5MB on the main logic board using 1MB 80ns SIMMs
- * On-board VGA compatible video circuitry
- * Sockets for optional 256K video RAM upgrade (MX-3750)
- * 101-key enhanced PS/2 style keyboard
- * Three 16-bit expansion slots
- * Three drive bays: Two 3.5 inch and One 5.25 inch
- * On-board high-density diskette drive controller
- * One 1.44MB 3.5 inch Panasonic JU-257A213P floppy drive
- * 16-bit SmartDrive connector
- * PS/2 compatible mouse port
- * One on-board serial port
- * One on-board parallel port
- * 100-Watt power supply

Tandy 4020SX Main Logic Board 25-4902/4903 (figure 269):**NOTES:**

The setup for the 4020SX is run from the "SETUPS20.COM" program which lies on the 4020SX utilities disk.

MEMORY CONFIGURATIONS:

1MB of RAM soldered on the main logic board.

TOTAL MEMORY	NUMBER OF SIMMS	TYPE OF SIMMS	BANKS USED	SOCKETS USED	
2MB	4	256KB 80ns	2,3	J4,J8,J9,J10	Factory Configuration
3MB	2	1MB 80ns	2	J9,J10	
5MB	4	1MB 80ns	2,3	J4,J8,J9,J10	

(continued on next page)

JUMPER SETTINGS:

BIOS ROM Jumpers E1-E2-E3 and E4-E5-E6

- * E1 and E2 - 32Kx8 ROMs
- E2 and E3 - Reserved
- E4 and E5 - Reserved
- * E5 and E6 - 32Kx8 ROMs

Video Mode Jumpers E7-E8-E9

- * E7 and E8 - Color
- E8 and E9 - Monochrome

Parallel Port Interrupt Jumpers E13-E14-E15

- E13 and E14 - IRQ 5
- * E14 and E15 - IRQ 7

Serial Port Interrupt Jumpers E16-E17-E18

- * E16 and E17 - IRQ 4 (COM1)
- E17 and E18 - IRQ 3 (COM2)

Multiple Frequency Monitor Jumpers E25-E26-E27

- E25 and E26 - Non-Standard Multiple Frequency Monitor
- * E26 and E27 - VGA Analog or Standard Multiple Frequency Monitor

Video Interrupt Jumpers (IRQ 9) E22-E23-E24

- * E22 and E23 - Disabled
- E23 and E24 - Enabled

Video Enable Jumpers E19-E20-E21

- * E19 and E20 - Enabled
- E20 and E21 - Disabled

Serial Port ID Jumpers E28-E29-E30

- E28 and E29 - Serial Port Enabled as COM3 or COM4
- * E29 and E30 - Serial Port Enabled as COM1 or COM2

Power Switch LED Jumpers E10-E11-E12

- E10 and E11 - Ties Power Switch LED to IDE Port Drive Active Signal
- * E11 and E12 - Ties Power Switch LED to 5V (Turns ON at Power Up)

* = Indicates Factory Settings

TANDY COMPUTER PRODUCTS

DIP SWITCH SETTINGS:

SWITCH	FUNCTION	POSITION
1	Parallel Port Enable	* ON - Enable OFF - Disable
2	Parallel Port Address	* ON - 378-37F hex (LPT1) OFF - 278-27F hex (LPT2)
3	Serial Port Enable	* ON - Enable OFF - Disable
4	Serial Port Address For COM1 or COM2	* ON - 3F8-3FF hex (COM1) OFF - 2F8-2FF hex (COM2)
4	Serial Port Address For COM3 or COM4	** ON - 3E8-3EF hex (COM3) OFF - 2E8-2EF hex (COM4)
5	Extended Parallel Port (Bidirectional)	* ON - Disable OFF - Enable
6	Diskette Drive Port Address	* ON - 3F0-3F7 hex (Primary) OFF - 370-377 hex (Secondary)
7	Smartdrive Port Enable	* ON - Enable OFF - Disable
8	Smartdrive Port Address	* ON - (Primary) 1F0-1F7 for CS0 3F6-3F7 for CS1 OFF - (Secondary) 170-177 for CS0 376-377 for CS1

* = Indicates Factory Setting

** = See Serial Port ID Jumper Setting

Panasonic JU-257A213P 3 1/2" 1.44 Meg Floppy Disk Drive (figure 219):

SW1 (RY/DC) : Ready/Disk Change. Default is "DC".

SW2 (MO/MS) : Motor ON/Motor ON Drive Select(MS). Default is "MO".

SW3 (O123) : Drive select. Default is "0".

SW4 (BCD) : Selects head assembly rank. This switch is used to match the logic board to the head. Set to letter marked on head assembly.

SW5 (PS2/AT) : Selects either PS2 polarity or AT polarity. Default is "PS2".

Power is supplied by the I/O cable.

```
*****  
*                                                                 *  
*                                                                 *  
*           T A N D Y   5 0 0 0 M C           *  
*                                                                 *  
*                                                                 *  
*****
```

TANDY COMPUTER PRODUCTS

Tandy 5000MC Main logic board (figure 208):

E1-E2 off (Normal configuration). This jumper is used to clear the CMOS RAM. Short E1-E2 with the power off to clear the memory, and replace the supplied jumper on the single pin it was stored on.

E3-E4 off (Normal configuration). Routes RTCINT to data bus when on.

E5-E6-E7-E8 no jumpers installed (Normal configuration). Changes operation of FDC port.

RAM Specifications

Organization	Access Time
256K x 9 SIMM	100 nS
1M x 9 SIMM	100 nS

Memory configurations:

2 MEG: SW1, position 4 on, all others off.
SW2, positions 1, 4, 8 on, all others off.
Jumpers installed on E9-E10, E11-E12, E14-E15, E16-E17.

4 MEG: SW1, positions 3, 4 on, all others off.
SW2, positions 4, 8 on, all others off.
Jumpers installed on E9-E10, E11-E12, E14-E15, E16-E17.

8 MEG: SW1, positions 4, 6 on, all others off.
SW2, positions 1, 4 on, all others off.
Jumpers installed on E9-E11, E10-E12, E14-E16, E15-E17.

16 MEG: SW1, positions 3, 4, 6 on, all others off.
SW2, position 4 on, all others off.
Jumpers installed on E9-E10, E11-E12, E14-E15, E16-E17.

Tandy 5000MC CPU board (figure 209):

There are no switches or jumpers on this board.

First and Second Tandy 5000MC Memory board (figure 201):

There are no switches or jumpers on this board. The board must be fully populated with SIMMs, all of one type (either 256k by 9 bit or 1 MEG by 9 bit page mode 100 ns SIMMS).

Permitted memory configurations in the Tandy 5000MC are:

- 2 MEG: one memory adapter with 8 100 ns 256k SIMMS
- 4 MEG: two memory adapters, each filled with 8 100 ns 256k SIMMS
- 8 MEG: one memory adapter with 8 100 ns 1 MEG SIMMS
- 16 MEG: two memory adapters, each filled with 8 100 ns 1 MEG SIMMS

The only difference between the first and second memory board in the Tandy 5000MC is the mounting bracket. The first board uses a mounting bracket secured with a screw concealed underneath the rear case bezel; the second board uses a microchannel bracket.

This page intentionally left blank.

TANDY COMPUTER PRODUCTS

```
*****  
*                                     *  
*                                     *  
*           T A N D Y   W P 2       *  
*                                     *  
*                                     *  
*****
```

TANDY COMPUTER PRODUCTS

WP-2 Portable Word Processor 26-3930 (figure 220):

Jumpers: There are no jumpers on this unit.

Notes: The unit comes standard with 256K of ROM and 32K of battery backed up RAM.

The internal RAM can be expanded to 64K by adding a 32K RAM chip (26-3932) to a socket inside the unit. Note: some of this RAM may be used by the system. See the text below for further details.

A 32K memory card may be added (26-3931) by inserting it into the expansion card slot on the side. The additional RAM will act as a diskette or a cassette tape to store files. See the text below for further details.

WP2 32K RAM Upgrade 26-3932 (figure 220):

There are no jumper changes required when installing the memory chip into the WP2. The memory chip is an M5M5256BP-10L, 28 pin IC and will be inserted into a 32 pin socket on the logic board. See figure 220 for proper installation. Once the memory chip is installed, it is necessary to 'format' it. To do this, you must be within an active document and not in the opening screen. Once in an active document, press <F2><=> to enter the files menu. Select "RAM DISK" from the menu with the arrow keys. Press <F1><F> and a warning message of "Are you sure (Yes/No)" will appear. Press <Y> and the message "Now formatting" will appear for a few seconds. After the format is completed, the RAM DISK is ready for use. Note: the RAM DISK is treated as a separate block of memory and does not expand the main memory.

WP2 32K Memory Card 26-3931 (figure 220):

There are no jumper changes required when using this device. This is a credit card sized device that will store an additional 32K of data for the WP2. The Memory Card is a non-volatile memory device and will store the information even when removed from the WP2. A backup battery holds the information in the Memory Card when not powered up or installed. To install the Memory Card simply slide it into the slot on the left hand side of the WP2. When the Memory Card is installed for the first time, it is necessary to 'format' it. To do this, you must be within an active document and not in the opening screen. Once in an active document, press <F2><=> to enter the files menu. Select "MEMORY CARD" from the menu with the arrow keys. Press <F1><F>, a warning message of "Are you sure (Yes/No)" will appear. Press <Y>, the message "Now formatting" will appear for a few seconds. After the format is completed, the MEMORY CARD is ready for use. Note: the MEMORY CARD is treated as a separate block of memory and does not expand the main memory.

```
*****  
*                                                                 *  
*                                                                 *  
*           T A N D Y   W P - 1 0 0           *  
*                                                                 *  
*                                                                 *  
*****
```

Tandy WP-100 26-3950 (figure 229):

The Tandy WP-100 Portable Word Processor is based on the HD64180 CPU, which is an 8-bit CPU with an integrated Memory Management Unit capable of addressing 1 Meg of physical memory space. It comes in one standard configuration as shown below: currently there are no upgrade options known:

- .HD64180 CPU.
- .32K of Text/Display SRAM plus 8K of Back-up Memory SRAM
- .Word Processing Software in Main ROM
- .A 50,000 word spelling dictionary in a second ROM
- .A beeper to indicate spell check errors, and other warnings
- .An 80 character x 8 row LCD display.
- .70 key Matsushita membrane keyboard with 30 character buffer
- .1 100K character 2.8" internal disk drive, 100-512 byte sectors per side in one spiral track in MFM format.

The WP-100 is AC powered, but has a non-rechargeable Lithium battery rated at 3 VDC to hold data in a user dictionary word list. All other contents or margin setting/mode changes made while power is on will be lost when power is turned off.

Main Logic Board Jumpers and Switches

The Tandy WP-100 has no switches on any of the logic boards. As noted in Figure 229, there are 6 soldered wire jumpers in place on the Control PCB, and open positions for 3 others not installed. The functions of the wired jumpers that are installed are shown below:

JP301	Memory Size Select
JP302	Gnd to CN306.14, to the LCD
JP303	Enable DMA Reg
JP304	Not installed
JP305	Main ROM Size Select
JP306	Main ROM Output Enable
JP307	Not installed
JP308	Not installed
JP309	Back-up SRAM Chip Enable

There are no known options that would require changing any of these jumper settings.

2.8" Quick Disk Drive (figure 263):

The 2.8" Quick Disk Drive uses a single track spiral disk (26-3951). Unlike the disks ordinarily used with computers, the single track spiral disk is not formatted with a number of concentric circular tracks. Instead, the surface of the disk is magnetically inscribed with a single track that spirals inward toward the center, much like the track on a phonograph record. There are no test points or jumpers with this drive.

```
*****  
*                                     *  
*                                     *  
*   3 S E R V E R 3                 *  
*                                     *  
*                                     *  
*****
```

26-5550 3SERVER3
 90-1660 3S200 SERVER
 90-1661 3S201 SERVER
 90-1662 3S202 SERVER

POWER ON SEQUENCE:

When powered on, the 3Server3 automatically runs a brief initialization procedure and then goes on to run the unit self test, which takes about 60 seconds.

When powered on for normal operation with application software on its disk, the server signals the end of the entire boot sequence by displaying the current date and time on the LCD.

When powered on for maintenance at thumbwheel setting 4, the server displays its network address when it completes the self test.

MAIN UNIT/CONTROL PANEL (figure 301):

The THUMBWHEEL SWITCH settings determine the 3Server3's startup and operating status.

The OPERATE/TEST toggle switch should be in the OPERATE position for all normal operations. When in the OPERATE position, this switch disables the STROBE and RESET buttons. The TEST position is used to enable the RESET button, which is done when installing software, performing routine maintenance, or running diagnostic tests.

The RESET button resets the 3Server3 when the OPERATE/TEST toggle is set to TEST. Do not press the RESET button (or power off the server) during the CMOS RAM diagnostic test that runs at startup time.

The STROBE Button is for service and diagnostic purposes only.

THUMBWHEEL SWITCH SETTINGS:

Setting	State	Console
0	Normal operation	None; printer or modem on Serial 1 port
1	Normal operation	Local console on Serial 1 port (output)
2	Factory use	
3	Installation/Maint.	Local MS-DOS console on Serial 1 port
4	Installation/Maint.	Network MS-DOS Ethernet console
5	Factory use	
6	Installation/Maint.	Network MS-DOS Apple Talk console
7	Factory use	

(continued on next page)

TANDY COMPUTER PRODUCTS

8	Installation/Maint.	Network MS-DOS Token Ring console
9	Factory use	
10	Front panel test	None
11	Extended unit self-test	"
12	Diagnostic use; TDR test	"
13	Extended unit self-test	"
14	Special services	"
15	Factory use; internal ROM debugger	"

NOTE: Extended unit self-test requires external loopback on serial port, Ethernet port, and Apple Talk port. Setting 11 does not stop on errors.

MAIN LOGIC CONNECTORS/JUMPERS (figure 302):

P1, Ethernet BNC Connector	J8, External Tape Drive Connector
P2, Parallel Connector	J9, Internal Tape Drive Connector
P3, Serial Connector	J11, Internal Disk Drive Connector
J1, RAM Expansion Connector	J12, Power Connector (Not used)
J2, Expansion Option Connector	J16, Optional DIX Interface Connector
J5, LCD Connector	J19, Led Connector
J6, Apple Bus Connector	J20, DIX/BNC Jumper
J7, External Disk Drive Connector	

Jumpers:	W007	No Jumper
	W008	No Jumper
	W009	No Jumper
	DIX/BNC	BNC Jumpered

NOTE: When replacing the main logic board, be sure to remove the original Ethernet address ROM located at U19 and install it into the new replacement board.

Hard Disk Controller Board Connectors/Jumpers (figure 303):

J0 (20 pins)	Data cable to disk drive 0
J1 (20 pins)	Data cable to disk drive 1 (if present)
J2 (34 pins)	Control cable to disk drive(s)
J3 (4 pins)	DC power to controller board
J4 (50 pins)	SCSI bus to Main Logic board

J5 No Jumpers (SCSI ID=0)

PU-R-S-T PU-R Jumpered
No others jumpered.

Hard Disk Drive Controller: RP3 and RP4 are to be installed only if the controller is the last device on the SCSI cable.

Hard Disk Drive Board (figure 304):

Disk Drive (Priam V-185)

J6, pin-pair 1 jumpered = drive select 1 for a single hard drive.

J6, pin-pair 2 jumpered = drive select 2 for a second of two hard drives.

RP1 is the terminator. It should be installed in the last drive of the cable.

Tape Drive Controller Board Connectors/Jumpers (figure 305):

J1 (50 pins) Interface cable to tape drive

J2 (4 pins) DC power to controller board

J3 (50 pins) SCSI bus to Main Logic board

J6 Jumpered (SCSI ID=7)

J7 Jumpered (SCSI ID=7)

J8 Jumpered (SCSI ID=7)

J9 Jumpered

J10 No Jumper

Tape Drive Controller: RN1, RN2, and RN3 are to be installed only if the controller is the last device on the SCSI cable.

Tape Drive (Wangtek 5099EN24) (figure 306):

E1 Jumpered

HDR 2,6 Jumpered

TNG Jumpered

IHC Jumpered

HDR3 3,11 Jumpered

7,15 Jumpered

NOTE: All others are not jumpered.

SCSI ID JUMPERS

The jumper for the base unit's internal disk should be set at SCSI ID 0.
Expansion disk SCSI ID jumpers should be set at unique numbers in the range of 1 to 6.

The jumper for the tape drive controller should be set at SCSI ID 7.

TANDY COMPUTER PRODUCTS

```
*****  
*                                     *  
*                                     *  
*      3 S E R V E R 3 8 6          *  
*                                     *  
*                                     *  
*****
```

26-5552 3S/401 386 SERVER**3SERVER386 Control Panel (figure 307):****POWER ON SEQUENCE**

When powered on, the 3Server386 automatically runs a brief initialization procedure and then goes on to run the unit self-test, which takes about 60 seconds. If the 3Server386 encounters any error, the test stops and an error message appears on the LCD.

When powered on for normal operation with application software on its disk, the server signals the end of the entire boot sequence by displaying its name and the current date and time on the LCD. The server is then ready for operation.

When powered on for maintenance BOOT switch setting 1 or 2, the server displays its network address when it completes the self-test.

CONTROL PANEL SWITCHES/BUTTONS

The RESET button restarts the 3Server386 when the MODE switch is set for maintenance or diagnostics, as if the power had just been turned on.

The MODE switch selects 3Server386 operation and test conditions. Maintenance mode allows you to run utility programs, when you want only DOS to be active. Diagnostics mode allows you to test various components of the 3Server386. Server mode is used for normal operation.

The BOOT switch settings, together with the MODE setting determine how the 3Server386 operates. These settings range from normal operation, which handles everyday use and installation needs, to maintenance and service settings, which enable server-based utility programs and various self-tests to operate.

The CONT button is used to display a second message on the LCD when the first message ends in a plus sign (+). It is also used in extended self-tests and other diagnostic operations.

The ATTN button is reserved. DO NOT USE THIS BUTTON during system power up, normal operation, maintenance, or diagnostics unless specifically directed to do so. Indiscriminate use of this button can cause the system to halt and lock up, or damage to the contents of CMOS RAM.

(continued on next page)

TANDY COMPUTER PRODUCTS

BOOT SWITCH SETTINGS:

<u>Setting</u>	<u>Server State</u>	
	(MODE = MAINTENANCE)	(MODE=DIAGNOSTICS)
*Ø	Local boot	Front panel test
1	Ethernet boot	All diagnostics
2	Token ring boot	Reserved
3	Reserved	Serial port external loopback test (asynchronous)
4		Ethernet external loopback test
5		Parallel port extended test
6		Reserved
7		Extended memory setup
8		RS-232C synchronous port external loopback test (not implemented)
9		Service use; view/clear error log
1Ø		Reserved
11		Reserved
12		Service use; CMOS test
13		Reserved
14		Reserved
15		Continuous POST

* denotes normal server operation

NOTE: When the MODE switch is in the server position (left), the BOOT switch has no effect.

INTERNAL CABLING**Hard Drive to Controller:**

The 2Ø-pin ribbon cable must be plugged into the rightmost connector on the disk controller board (labeled J3). Also, the darker striped edge of the cable must be matched with the side of the connector that is labeled "1". The 34-pin ribbon cable can be plugged to only one connector so, unless it is twisted, it is unlikely to present a connection problem. The hard drive must have the terminator installed.

SCSI Connector to DISK Controller:

The 5Ø-pin SCSI cable is attached to the disk controller board. Make sure the colored edge of the ribbon cable connects to pin 1 of position JØ on the disk controller board. The disk controller must have terminators installed.

SCSI Connector to TAPE drive:

The 5Ø-pin SCSI cable is plugged into the connector on the back of the tape drive. Make sure the colored edge of the ribbon cable connects to pin 1 of the SCSI connector.

TANDY COMPUTER PRODUCTS

Main Logic Board Jumpers/Connectors (figure 308):

NOTE: When replacing the main logic board, be sure to remove the original Ethernet address ROM located at U378 and install it into the new replacement board.

- JP200 *Not Jumpered = Server configuration
 Jumpered = Workstation configuration, allows for keyboard and monitor attachment
- JP201 *Not Jumpered = External transceiver
 Jumpered = Internal transceiver
- JP202 Serves as a spare jumper holder only
- JP275 *Jumpered = Connects chassis to logic ground
- JP526 1,8 pin pair jumpered (This is the pin pair closest to the expansion bus) = SCC (8530) interrupt to IRQ15
- JP600 No jumpers are installed on JP600. The functions of the jumpers are:
- A - Reserved
 - B - Jumpered allows diagnostic test loop
 Not jumpered = no test loop
 - C - Not jumpered = LCD display
 Jumpered = monitor display
 - D - Jumpered = disabling of keylock
 Not jumpered = bypassing of keylock

* denotes standard server configuration

MAIN LOGIC CONNECTORS:

- J1, J2, J3, J4 AT Type Expansion Connectors
- J50 Internal SCSI Connector
- J51 External SCSI Connector
- J58 ASYNC Serial/Parallel Connector
- J57 Apple Talk Connector
- J55 Serial A, Serial B Connectors (Sync)
- J60 Service Only, Enhanced Keyboard Connector
- J200 LCD Panel Connector
- J250 BNC Ethernet Connector
- J225 DIX Connector
- J275 Power Connector
- J276 Power Connector (Not Used)
- J500, J501 Memory Expansion Connectors

Drive Controller Board (figure 309):

CD and MN pin pairs jumpered. CD and MN set the Drive to SCSI ID=2

Hard Drive (figure 310):

Drive Select 1 jumpered on rear of drive. (This is the first set of jumpers from the left).

Tape Drive Unit Jumpers (figure 311):

The 4th jumper from the power connector enables parity and is the only jumper installed.

SCSI ID JUMPERS

The jumper for the base unit's internal disk should be set at SCSI ID 2. Expansion disk SCSI ID jumpers should be set at unique numbers in the range of 3 to 6.

The jumpers for the tape drive (SEL0, SEL1 & SEL2) should be set at SCSI ID 0 (no jumpers installed), whether the tape is installed in the 3Server386 or in the Expansion Unit.

If the 3Server386 has a maximum configuration of six disk drives, the jumper for the last physical expansion drive attached to the system should be set at SCSI ID 1.

This page intentionally left blank.

```
*****  
*                                                                 *  
*                                                                 *  
*           F L O P P Y   D R I V E S           *  
*                                                                 *  
*                                                                 *  
*****
```

TANDY COMPUTER PRODUCTS

Shugart SA800 8" (Discrete and LSI. Figures 32, 33, and 34):

Push On --- A, B, C, DC, DS, DS1, T1, T2, Z, 800

L (Present on discrete boards only, jumpered vertically)

Wire Wrap - FROM

TO

J1-4	T6	(On row furthest from conn.)
J1-6	T5	"
J1-8	T4	"
J1-10	T3	"

Wire wrap jumpers are used only with early (AXX-0505) style FDC board.

CDC 8" (Discrete figure 35):

Remove pin 14 of the resistor pak.

Dip Switch 1 (8 position): Positions 1-4 Drive select (only one on)
 Position 5 Ready (always on)
 Positions 6-8 Spares (always off)

Dip Switch 3 (7 position): Positions 1-3 Off
 Position 4 On
 Positions 5-7 Off

SW3 may not be installed. If not, position 4 should have a jumper wire.

CDC 8" (LSI figure 36):

Remove pin 9 of the resistor pak.

Drive Select 8 pin dipshunt numbered 1-4 on the PCB but Radio Shack numbers their drives 0-3. Short only the jumper for the desired drive.

TPI 8" (figure 37):

Drive 0 Only: T1, T8 (these should be installed with early style FDC and removed with the late style FDC board.)

On Rev. B and later boards, install a wire jumper across the pads of 1S, SYS4, SYS5, and SYS6. This will allow for proper termination when either a terminator or an expansion bay is used.

Drive 1 Only: T3, T4, T5, T6, T7, and T8

All Drives : E1-E2

E3-E4

DSx (x = appropriate drive select number)

TANDY COMPUTER PRODUCTS

Tandon in Model 16's (figure 30):

M1 Enables 20 second wait before the motor shuts off

M3 Starts the spindle motor on drive select

There should be one DSx jumper located just above the stepper motor.

Drive 0 would be jumpered DS1 and drive 3 would be jumpered DS4.

There should be NO M2 jumper installed. If M2 is installed, the motor will run continuously, which would conflict with the design of the system.

In Model 16's one and only one internal drive should have a resistor pack installed in RP1 with pins 1,2,4,6,7,8 and the pins across from them removed. The resistor pack should be installed in the drive furthest from the FDC board in the computer. This terminates the head load and side select lines.

The dip shunt labeled U3 or HLL should have the connection between pins 2 and 15 broken or have one of those pins removed from the IC socket. This enables the stepper motor at all times.

Tandon in Model 12's (figure 30):

M1 Enables 20 second wait before the motor shuts off

M3 Starts the spindle motor on drive select

There should be one DSx jumper located just above the stepper motor.

Drive 0 would be jumpered DS1 and drive 3 would be jumpered DS4.

There should be NO M2 jumper installed. If M2 is installed, the motor will run continuously, which would conflict with the design of the system.

In Model 12's one and only one internal drive should have a resistor pack installed in RP1 with all the pins plugged into the socket. The resistor pack should be installed in the drive furthest from the FDC board on the drive cable, usually drive 0.

The dip shunt labeled U3 or HLL should have the connection between pins 2 and 15 broken or have one of those pins removed from the IC socket. This enables the stepper motor at all times.

Tandon in Expansion Bays (figure 30):

M1 Enables 20 second wait before the motor shuts off

M3 Starts the spindle motor on drive select

There should be one DSx jumper located just above the stepper motor.

Drive 0 would be jumpered DS1 and drive 3 would be jumpered DS4.

There should be NO M2 jumper installed. If M2 is installed, the motor will run continuously, which would conflict with the design of the system.

(continued on next page)

TANDY COMPUTER PRODUCTS

In expansion bays one and only one drive in the bay should have a resistor pack installed in RP1 with pins 1 and/or 16 removed. The resistor pack should be installed in the drive furthest from the FDC board on the drive cable. This leaves the head load signal unterminated.

The dip shunt labeled U3 or HLL should have the connection between pins 2 and 15 broken or have one of those pins removed from the IC socket. This enables the stepper motor at all times.

Tandon TM848-2E Direct Drive Logic Board (figure 41):

DSx Drive Select (DS1 = Drive 0)
DC Disk Change signal available
2S Two-Sided diskette signal available
TR True Ready
XC External Write current switch
MOH Motor control signals are active high
M3 Motor control using Drive Select
M1 Enables 5 second motor off delay
DM Enables diagnostics mode

NOTE: The MOH jumper may vary from machine to machine. This jumper will either be on or off. For example; with the jumper on: if after the drive has been selected the motor never turns off the jumper should be removed.

In Model 16s one and only one internal drive should have a resistor pack installed in RP1 with pins 1,2,4,6,7,8 and the pins across from them removed. The resistor pack should be installed in the drive furthest from the FDC board in the computer. This terminates the head load and side select lines.

In Model 12s one and only one internal drive should have a resistor pack installed in RP1 with all the pins plugged into the socket. The resistor pack should be installed in the drive furthest from the FDC board on the drive cable, usually drive 0.

TEAC FD-54B Drive Logic Board (figure 43):

IU Selects active in use signal
DSx Drive Select, x = 0-3 (DS0 = Drive A, DS1 = Drive B)
Termination (RA1) will be on all drives.

TEAC FD-55BV Drive Logic Board (figure 107):

DSx Drive Select x = 0-3 (DS0 = Drive A, DS1 = Drive B)
Termination (RA1) will be on all drives.

TANDY COMPUTER PRODUCTS

Tandon TM100-2 Drive Logic Board (figure 47):

Dip Shunt (1E) All broken except 3-14 drive select 1
Terminating resistor pak should be installed at location 2F

The following are jumper wires not plugs.

W1 Selects double sided drive
W2 Disables set/preset on write flip-flop
W4 Enables write protect control
W6 Activity LED is controlled with drive select signal
W8 Allows drive to be selected via J1 pin 6

Tandon TM65-2L Floppy Drive Logic Board (figure 98):

This drive is used only in the dual floppy version of the Tandy 1200.

DS1 Both floppy drives in system have DS1 as the cable selects the drive.
J34 B-C Spindle motor controlled by drive select

Mitsubishi M4853, Mark I (figure 40):

3, 4, 5, 6, 7, 8, and 9 are for termination and should only be installed on the last drive on the cable.

DSx Drive Select (x = 0-3)
HC Causes a constant head load condition
MM Causes motor on when drive is selected
H1 Routes ready signal R3 to the head load circuitry
R3 Establishes a ready signal when a diskette is inserted in the drive and the door is closed.

Mitsubishi M4853-1, Mark II (figure 50):

HC Selects constant head load after door closed
2S Selects constant drive ready
MM Selects active low motor on
DSx Drive select (x = 0-3)
The terminating resistor pak should be installed at location B6 on the last drive on the cable.

Mitsubishi M4851 360K Drive Logic Board (figure 96):

DS1 Both floppy drives in system use DS1 as the cable selects the drive
HC Causes head load with door closed
DC Resets status on falling edge of step pulse
MM Selects active low motor on
The terminating resistor pak should be installed in the last drive on the cable.

Mitsubishi MF501A 360K Drive Logic Board (figure 108):

DS1 Both floppy drives in system use DS1 as the cable selects the drive
MM Spindle motor power controlled by 'MOTOR ON' signal
The terminating resistor pak should be installed in the last drive on the cable.

Mitsubishi M4854-347 1.2 MEG Drive Logic Board (figure 97):

DS1 Both floppy drives in system use DS1 as the cable selects the drive
TD Termination select
HC Selects constant head load
UD Disables head unload delay
DC Selects active low diskette change
MM Spindle motor power controlled by 'MOTOR ON' signal
RR Output selected by 'DRIVE SELECT' signal
SB Selects 360 RPM for both high and low density modes
1IH LED will light with the 'DRIVE SELECT' signal
The terminating resistor pak should be installed in the last drive on the cable.

Mitsubishi MF504A 1.2 MEG Drive Logic Board (figure 109):

DS1 Both floppy drives in system use DS1 as the cable selects the drive
TD Connect drive select terminator
DC Diskette Change, activates signal when drive latch opened
MM Spindle motor power controlled by 'MOTOR ON' signal
RR Output selected by 'DRIVE SELECT' signal
SB Selects 360 rpm for both high and low density modes
The terminating resistor pak should be installed in the last drive on the cable.

Teac FD-35-FN 3 1/2 inch 720K Floppy Drive (figure 132):

DSx Drive Select, x = 0-3 (DS0 = Drive A, DS1 = Drive B)
MO Enables use of motor on signal
FG Connects frame ground to logic 0V
Termination is internal to the drive.

Sony MP-F73W-01D 3 1/2 inch 1.44 Meg Floppy Drive (figure 141):

DS1 ALL Drives Slide Switch on back right corner set to second closest position to the rear of the drive.
Termination is internal to the drive.

Teac FD55BV-221 5 1/4 inch 360K Floppy Drive (figure 142):

DSx Drive Select, x = 0-3 (DS0 = Drive A, DS1 = Drive B)
Termination is internal to the drive.

Teac FD55BR-521 5 1/4 inch 360K Floppy Drive (figure 143):

DSx Drive Select, x = 0-3 (DS0 = Drive A, DS1 = Drive B)
Termination is internal to the drive.

TANDY COMPUTER PRODUCTS

Sony MP-F63-01D 3 1/2 inch 720K Floppy Drive (figure 144):

DS0 Drive A Slide switch all way to rear of drive
 DS1 Drive B Slide switch second notch from rear of drive
 Termination is internal to the drive.

Mitsubishi MF504B 5 1/4 inch 1.2 MEG Drive Logic Board (figure 154):

DS0 Used in non-standard setups when cable is straight (no twists) where two 5 1/4" floppy drives are used. The second drive would be DS1.
 DS1 Both floppy drives in system use DS1 if the cable has a twist between the drive connectors
 TD Connect drive select terminator.
 DC Diskette change.
 IR LED lit when drive selected (Jumper IU must be off).
 MM Spindle motor power controlled by 'MOTOR ON' signal.
 RI Index pulse is issued only when spindle completes one rotation.
 SB Selects 360rpm for both high and low density modes.
 The terminating resistor pack should be installed in the last drive on the cable.

Teac FD-55BR121 5 1/4 inch 360K Floppy Drive (figure 211):

Dx Drive Select, x = 0-3 (D0 = Drive A, D1 = Drive B)
NOTE: Figure 211 shows D0 selected.
 Termination is internal to the drive.
 FG Jumped Frame Ground
 IU Jumped In Use
 All other jumpers should be off.

Sony MP-F17W-71 3 1/2 inch 1.44M Floppy Drive (figure 141):

DS0 Drive A Slide switch all the way to the rear of the drive.
 DS1 Drive B Slide switch second notch from the rear of the drive.
 Termination is internal to the drive.

Sony MP-F73W-70D 3 1/2 inch 1.44 MEG Floppy Drive (figure 141):

DSx Drive Select, x = 0-3 (DS0 = Drive A, DS1 = Drive B)
 Termination is internal to the drive.

Sony MP-F17W-70D 3 1/2 inch 1.44 MEG Floppy Drive (figure 141):

DSx Drive Select, x = 0-3 (DS0 = Drive A, DS1 = Drive B)
 Termination is internal to the drive.

Citizen OPBD-12A 3 1/2 inch 720K Floppy Drive (figure 213):

DS0 Drive A - Slide switch all the way to the rear of the drive.
 DS1 Drive B - Slide switch second notch from the rear of the drive.
 Termination is internal to the drive.

Citizen OSDC-95A 3 1/2 inch 720K Floppy Drive (figure 160):

DS0 Drive A - Slide switch all the way to the rear of the drive.
DS1 Drive B - Slide switch second notch from the rear of the drive.
Termination is internal to the drive.

Mitsubishi MF504C 5 1/4 inch 1.2 MEG Drive Logic Board (figure 216):

DS0 Used in non-standard setups when cable is straight (no twists) where two 5 1/4" floppy drives are used. The second drive would be DS1.
DS1 Both floppy drives in system use DS1 if the cable has a twist between the drive connectors
TD Connect drive select terminator.
DC Diskette change.
IR LED lit when drive selected (Jumper IU must be off).
MM Spindle motor power controlled by 'MOTOR ON' signal.
RI Index pulse is issued only when spindle completes one rotation.
SB Selects 360rpm for both high and low density modes.
The terminating resistor pack should be installed in the last drive on the cable.

TEAC FD235F-105U 3 1/2 inch 720K Drive Logic Board (figure 215):

D0 Drive select 0.
D1 Drive select 1.
Left pins of RY and DC should be jumped (Connects Ready input to pin 34 of ribbon cable signal. All other jumpers should be off.
Power is derived from ribbon cable (no separate power connector).
Termination is internal to the drive.

TEAC FD235F-136U 3 1/2 inch 720K Drive Logic Board (figure 218):

This drive is used in the 1400FD/HD laptop computer.
D0 Drive select 0.
D1 Drive select 1.
All other jumpers should be off.
Power is derived from ribbon cable (no separate power connector).
Termination is internal to the drive.

Sony MP-F63W-70D 3 1/2 inch 720K Drive Logic Board (figure 144):

DS0 Drive A Slide switch all the way to the rear of the drive.
DS1 Drive B Slide switch second notch from the rear of the drive.
Power is derived from ribbon cable (no separate power connector).
Termination is internal to the drive.

TANDY COMPUTER PRODUCTS

Sony MP-F11W-71 720K Drive Logic Board (figure 144):

DS0 Drive A Slide switch all the way to the rear of the drive.
 DS1 Drive B Slide switch second notch from the rear of the drive.
 Power is derived from ribbon cable (no separate power connector).
 Termination is internal to the drive.

Sony MP-F11W-72 720K Drive Logic Board (figure 144):

DS0 Drive A Slide switch all the way to the rear of the drive.
 DS1 Drive B Slide switch second notch from the rear of the drive.
 Power is derived from ribbon cable (no separate power connector).
 Termination is internal to the drive.

Matsushita EME-213AMC 3 1/2 inch 720K Floppy Drive 25-3530 (figure 217):

This drive is for the 1100FD. There are NO jumpers on this drive.
 Test points are as follows:

Head amp	TP1
Head amp	TP2
GND	TP3
Track 00	TP5
Index	Pin 23 of the floppy drive connector cable

Panasonic JU-257A213P 1.44 MEG Floppy Drive for 2800HD (figure 219):

SW1(RY/DC): Ready/Disk Change. Default is "DC".
 SW2(MO/MS): Motor ON/Motor on Drive Select(MS). Default is "MO".
 SW3(0321) : Drive Select. Default is Drive "0".
 SW4(BCD) : Selects head assembly rank. This switch is used to match the
 logic board to the head. Set to letter marked on head assembly.
 SW5(PS2/AT): Selects either PS2 polarity or AT polarity. Default is PS2.

Power supplied by I/O cable.

2.8" Quick Disk Drive for WP100 (figure 263):

The 2.8" Quick Disk Drive uses a single track spiral disk (26-3951). Unlike the disks ordinarily used with computers, the single track spiral disk is not formatted with a number of concentric circular tracks. Instead, the surface of the disk is magnetically inscribed with a single track that spirals inward toward the center, much like the track on a phonograph record. There are no test points or jumpers with this drive.

TANDY COMPUTER PRODUCTS

Teac FD235HF-106U 1.44 Meg 3 1/2 inch Floppy Drive (figure 275):

There are two sets of jumper blocks located at the rear of the floppy drive. The following is a list of the jumpers and their functions:

FG: Frame ground. This jumper is permanently installed.
 D0: Drive select zero.
 D1: Drive select one.
 HHI: Logic HI sets the drive in high density mode (not used).
 LHI: Logic LOW sets the drive in high density mode (not used).
 OP: High density switch enabled (jumpered).
 HHO: High density output on high (not used).
 D2: Drive select two. Jumper between D2 and center pin.
 D3: Drive select three. Jumper between D1 and center pin.

Termination is internal to the drive.

Matsushita EME-263MG 3 1/2 inch 1.44M Floppy Drive 25-3506 (figure 300):

This drive is for the 1500HD/2810HD/3810HD. There are no jumpers on this drive. The test points are as follows:

Head Amp	TP1
Track 00 Check	TP5
Track 00 Bias	TP6 (Shorting it to ground enables Track 00 check)
Index	Pin 2 of the floppy drive connector cable
Read Data	Pin 24 of the floppy drive connector cable
Head 0 Connect	CN1
Head 1 Connect	CN2
VCC (+5V)	CN8 Pins 1,3,5,7
Ground	CN8 Pins 13,15,17,19,21,23,25

This drive is interfaced through a soldered on flat conductor cable instead of the conventional ribbon cable.

Sony MFD-17W-72 3 1/2" 1.44M Floppy Drive (figure 141):

The floppy drive is a Sony MFD-17W-72 1.44 Meg 3.5 inch drive. The following is a list of the test points and their functions:

Differential read amps	RFA, RFB
Direction	CN1Ø1, pin 18
Step	CN1Ø1, pin 2Ø
Track Ø	CN1Ø1, pin 26
Index	CN1Ø1, pin 8
Read Data	CN1Ø1, pin 3Ø
Ground	CN1Ø1, pin 13
Write Protect	CN1Ø1, pin 28
Motor On	CN1Ø1, pin 16

The drive is internally terminated. There is a single drive select switch on the side. Drive A: should be set for DSØ, Drive B: should be set for DS1, etc. If a 5 1/4" drive is added to the system, it must also be terminated.

This page intentionally left blank.

```
*****  
*                                     *  
*                                     *  
*           H A R D   D R I V E S   *  
*                                     *  
*                                     *  
*****
```

TANDY COMPUTER PRODUCTS

TRS-80 HARD DRIVE NOTES:

The 5, 12, 35, 70 and external 15 MEG controller boards are interchangeable as are the 12, 35, 70 and external 15 MEG interface boards. However, the controller boards should be replaced with like boards. So if the controller is the later WD1010 you should not replace it with the earlier 8x300. The 8 MEG interface or controller boards are **NOT** interchangeable with the 5, 12, 35, 70 or external 15 MEG.

For troubleshooting and diagnostic purposes the 5 MEG hard drive can be placed on a Model II/12/16/16B computer provided the 12 MEG interface board is used. Likewise the 12, 15, 35, and 70 MEG hard drives can be placed on a Model I/III/4 computer; however, 15 MEG is the maximum size these systems will recognize. So the 35 and 70 MEG drives will not be fully checked out.

The 5, 10, 12, and 15 MEG full height hard drives all use the same drive logic board. However, the 10 and 15 MEGs have a different ROM code in the processor chip. The chip can be identified by the version number on the IC package. The 10 and 15 MEGs use a Ver. 3.x ROM code. The 5 and 12 MEGs use a Ver. 2.x.

There are also two types of media (plated and oxide) for the 10 and 15 MEG full height bubbles. Each type requires a different logic board. Refer to Technical Bulletin HD:29 for a more detailed description. Refer to Technical Bulletin HD:32 for the procedure to convert one type of logic board to the other.

Refer to the Appendix for a list of hard drives with their respective head and cylinder counts.

In the Model II and 16 the hard disk interface board must be placed after the FDC board while in the 12, 16B and 6000 it must be in the bottom slot. The exception here would be ARCNET interface board which would be installed before the hard disk interface board. The disk cartridge interface board for the Tandy 6000 is terminated. Because of this, it **MUST** be the **LAST** interrupt driven board in the card cage.

TANDY 1000/1200 HARD DRIVE NOTES:

The Tandy 1000 WD1002/S-WA2 hard drive controller and the Tandy 1200 WD1010 (short) hard drive controller appear identical but they **ARE** different and are **NOT** interchangeable. For identification purposes refer to the following:

Tandy 1000 25-1001 AX-9009
 PC board vendor number = 61000007-13 (on adhesive label)
 ROM at U14, number suffix will be -01 or -010
 R13, R14, and C18 are on the board

Tandy 1200 25-3000 AX-9010
 PC board vendor number = 61000007-11 (on adhesive label)
 ROM at U14, number suffix will be -03
 R13, R14, and C18 are **NOT** on the board

TANDY COMPUTER PRODUCTS

8 MEG Hard Disk Interface Board in a Model II/16/16B/6000 (figure 19):

AP-AK Sets the RAM as pages 14 & 15 (the manual is incorrect)

In the Model II/16/16B/6000 there should be 64K standard main board memory which does not have memory mapped out at pages 14 & 15, so the AP-AK setting on the hard drive interface board presents no addressing conflict. If, for some reason a Model 16B/6000 should have an additional 16K of memory installed as main board memory, and the AK-AP jumper selected, an addressing conflict would result. The computer should be checked to insure that it has the correct amount of memory.

S1 1,3,5, and 7 on 2,4,6, and 8 off Configures drives 4 & 5
 S2 1,3,5, and 7 on 2,4,6, and 8 off Configures drives 6 & 7
 S3 3 & 4 on 1,2,5,6,7, and 8 off defines the port address as C0-CF
 W-V Pulls up an input of U26
 A-B Pulls up an input of U1

8 MEG Hard Disk Interface Board in a Model 12 (figure 20):

AG-AL Sets the RAM as pages 8 & 9 (the manual is incorrect)

In the Model 12 there should be 80K standard main board memory, which is qualified by a wire jumper from E38-E39. This additional memory is mapped out to pages 14 & 15, therefore the AK-AP option for the hard disk interface board would cause an addressing conflict, and must be moved to the suggested AG-AL option.

S1 1,3,5, and 7 on 2,4,6, and 8 off Configures drives 4 & 5
 S2 1,3,5, and 7 on 2,4,6, and 8 off Configures drives 6 & 7
 S3 3 & 4 on 1,2,5,6,7, and 8 off defines the port address as C0-CF
 W-V Pulls up an input of U26
 A-B Pulls up an input of U1

12 MEG Hard Disk Interface Board in a Model II/16/16B/6000 (figure 21):

AP-AK Sets the RAM on this board as pages 14 & 15

W-V Pulls up an input of U26

A-B-C Set to A-B which pulls up an input of U1

A-B-C-D-E Set to A-B which defines the port address of the board as C0-CF

In the Model II/16/16B/6000 there should be 64K standard main board memory which does not have memory mapped out at pages 14 & 15, so the AP-AK setting on the hard drive interface board presents no addressing conflict. If, for some reason a Model 16B/6000 should have an additional 16K of memory installed as main board memory, and the AK-AP jumper selected, an addressing conflict would result. The computer should be checked to insure that it has the correct amount of memory.

TANDY COMPUTER PRODUCTS

12 MEG Hard Disk Interface Board in a Model 12 (figure 22):

AG-AL Sets the RAM on this board as pages 8 & 9
 W-V Pulls up an input of U26
 A-B-C Set to A-B which pulls up an input of U1
 A-B-C-D-E Set to A-B which defines the port address of the board as C0-CF

In the Model 12 there should be 80K standard main board memory, which is qualified by a wire jumper from E38-E39. This additional memory is mapped out to pages 14 & 15, therefore the AK-AP option for the hard disk interface board would cause an addressing conflict, and must be moved to the suggested AG-AL option.

8 MEG Hard Disk Controller Board (figure 23):

Q-R When using a WD1100-02 for U4
 S-R When using a WD1100-12 for U4
 U-V Selects on board RAM using the RB* signal
 J-K Allows CS* only to enable waits back to the interface board.

12 & 5 MEG 8X300 Hard Disk Controller Board (figure 24):

1-2 When using a WD-1100-12 for U5
 2-3 When using a WD-1100-02 for U5
 5-6 Allows DCRCS* only to enable waits back to the computer
 17-19 Defines the port address of the board as C0-CF

15 MEG Internal Hard Drive Controller/Interface (figure 38):

E1-E2 Selects port address C0 to CF
 E6-E7 Connects DRD1 to U27 (WD1100-11)

8 MEG Shugart (SA1004) Hard Drive Logic Board (figure 25):

DSx Selects which drive number this board is (drive 4 is DS1)

Any board can have either an IC installed at location 3C or a stepper board connected to J9 (NOT BOTH). Stepper boards are being discontinued and replaced by the ROM that plugs into the socket at 3C. Also, replacement boards may come without either the stepper PCB or the ROM, so it would be a good idea to stock a spare ROM (AMX-5136). Last drive in chain should have a resistor pak (220/330 ohm) installed at 8C.

TANDY COMPUTER PRODUCTS

12 (TM603) and 15 (TM503) MEG Tandon Hard Drive Logic Board (figure 26):

Sx Selects which drive number this board is (drive 4 is S1)
W13 Allows the use of 6 heads
W7 Terminates the read data lines
W8 Terminates the write data lines

NOTE: In the 5, 12, and 15 Meg hard drives, the last drive on the chain (the drive furthest from the computer on the drive cable) must have a terminator (220/330 ohm) installed at location U22.

U4 Processor 2.XX Version 12 Meg
U4 Processor 3.XX Version or ALL Masked 15 Meg

5 MEG Tandon (TM602) Hard Drive Logic Board (figure 27):

Sx Selects which drive number this board is (drive 4 is S1)
W5 Selects a maximum of 153 cylinders
W7 Terminates the read data lines
W8 Terminates the write data lines

NOTE: In the 5, 12, and 15 Meg hard drives, the last drive on the chain (the drive furthest from the computer on the drive cable) must have a terminator (220/330 ohm) installed at location U22.

10 MEG Tandon (TM502) Hard Drive Logic Board (figure 48):

Sx Drive select (1-4) also labeled as W12-W9
W7 Terminates the read data lines
W8 Terminates the write data lines
Terminating resistor pak (220/330 ohm) should be installed at location U22.

10 MEG Tandon (TM-252) Hard Drive Logic Board (figure 76):

W14 Motor backlash option - set by the factory - do not change.
DSx Drive select (W12=DS1, W11=DS2, W10=DS3, W9=DS4)
Last drive on cable should have terminating resistor (220/330) at U19.

On the external hard drive, the orange wire connects to feedthrough connected to J2 pin 7 which routes +12V from the data cable to the relay which switches AC on to the power supply.

NOTE: DS2 (W11) is used to configure for drive C:.
 DS3 (W10) is used to configure for drive D:.

External WD1000-TB1 Controller Board (figure 52):

E1-E2 Enables software reset of WD1010 chip
E3-E4 Selects port address C0-CF
E11-E12 Connects oscillator to write clock circuit
E13-E14 Adds pull-ups to write protect lines of drive

TANDY COMPUTER PRODUCTS

35 MEG Quantum (Q540) Hard Drive Logic Board (figure 51):

DSx Drive select (x = 1-4)

Terminating resistor pak (220/330 ohm) should be installed at RN3 for the last drive on the cable.

70 MEG Micropolis (1325) Hard Drive Logic Board (figure 70):

DSx Drive Select (1-4)

W1 Fault status latch

W2 Selects daisy chain operation

W8 Selects radial data operation

RN1 Termination resistor pak (220/330 ohm) should be installed in the last drive on the cable.

Xebec Hard Drive Controller Board for Tandy 1000/1200 (figure 69):

The Xebec controller board is used for external hard drives only.

	<u>Tandy 1000</u>		<u>Tandy 1200</u>
IRQ2	Selects interrupt request 2	IRQ5	Selects interrupt request 5
INT2	Selects interrupt request 2	INT5	Selects interrupt request 5

The following jumpers are valid for both computers.

PD Enables processor data buffers

I/OADD1 Along with I/OADD2 selects base I/O address (320H) of board

I/OADD2 Along with I/OADD1 selects base I/O address (320H) of board

<u>DRIVE C:</u>	<u>1</u>	<u>2</u>	<u>DRIVE D:</u>	<u>3</u>	<u>4</u>
35 MEG	ON	OFF	35 MEG	ON	OFF
15 MEG	OFF	OFF	15 MEG	OFF	OFF
10 MEG	OFF	ON	10 MEG	OFF	ON

To support 20 MEG hard drives remove the ROM at U33 and replace it with the revised ROM, then set the jumpers according to the bubble type as follows:

<u>DRIVE C:</u>	<u>1</u>	<u>2</u>	<u>DRIVE D:</u>	<u>3</u>	<u>4</u>
35 MEG	ON	OFF	35 MEG	ON	OFF
20 MEG	OFF	OFF	20 MEG	OFF	OFF
10 MEG	OFF	ON	10 MEG	OFF	ON

Original ROM: MXP-0359 Checksum = A800H (supports 10, 15 and 35 MEG.)

Revised ROM: MXP-0358 Checksum = A900H (supports 10, 20 and 35 MEG.)

Refer to Technical Bulletin HD:46 for more information.

TANDY COMPUTER PRODUCTS

Tandy 1000 WD1002S-WX2 Controller Board (figure 77):

- W1 pins 1-2 Connects 'DSEL0' (drive select) to bus
- W2 pins 1-2 Connects 'RG' (read gate) into circuit
- W3 pins 1-2 Connects 'ROMEN' (ROM enable) to ROM
- W4 pins 2-3 Connects 'A2' (address line 2) for address select
- W6 pins 2-3 Connects 'RWC' (reduced write current) to J1 (drive)
- W7 pins 2-3 Selects IRQ2

The following are eight (8) sets of jumpers labeled SW1 positions 1-8. Notice that they are numbered from the bottom 1 through 4 and then backwards 8 through 5.

- Position 5 ON Selects address
- Position 6 OFF Selects address
- Position 7 OFF Selects address
- Position 8 OFF Selects address
- Position 4 With position 3 selects Drive D type
(See below for drive types)
- Position 3
- Position 2 With position 1 selects Drive C type
(See below for drive types)
- Position 1

DRIVE C:	1	2	DRIVE D:	3	4
35 MEG	ON	ON	35 MEG	ON	ON
15 MEG	ON	OFF	15 MEG	ON	OFF
10 MEG	OFF	ON	10 MEG	OFF	ON

For 20 MEG hard drive support, use the following table and refer to Technical Bulletin 1000:37 for more information.

DRIVE C:	1	2	DRIVE D:	3	4
35 MEG	ON	ON	35 MEG	ON	ON
20 MEG	ON	OFF	20 MEG	ON	OFF
10 MEG	OFF	ON	10 MEG	OFF	ON

The Tandy 1000 WD1002S-WX2 hard drive controller and the Tandy 1200 WD1002S-WX2 (short) hard drive controller appear identical but they ARE different and are NOT interchangeable. For identification purposes refer to the following:

Tandy 1000 25-1001 AX-9009
 PC board vendor number = 61000007-13 (on adhesive label)
 ROM at U14, number suffix will be -01 or -010
 R13, R14, and C18 are on the board

Tandy 1200 25-3000 AX-9010
 PC board vendor number = 61000007-11 (on adhesive label)
 ROM at U14, number suffix will be -03
 R13, R14, and C18 are NOT on the board

TANDY COMPUTER PRODUCTS**Tandy 1200 WD1002S-WX2 Hard Drive Controller Board (figure 99):**

W1 pins 1-2 Connects 'DSEL0' (drive select) to bus
 W2 pins 1-2 Connects 'RG' (read gate) into circuit
 W3 pins 1-2 Connects 'ROMEN' (ROM enable) to ROM
 W4 pins 2-3 Connects 'A2' (address line 2) for address select
 W6 pins 2-3 Connects 'RWC' (reduced write current) to J1 (drive)
 W7 pins 1-2 Selects IRQ5

The following are eight (8) sets of jumpers labeled SW1 positions 1-8. Notice that they are numbered from the bottom 1 through 4 and then backwards 8 through 5.

Position 5	OFF	Selects IRQ5
Position 6	OFF	Selects address
Position 7	OFF	Selects address
Position 8	OFF	Selects address
Position 4	Not Used	
Position 3	Not Used	
Position 2	With position 1	selects Drive C type
Position 1		(See below for drive types)

Tandy ROM		
62-000052-010		
DRIVE C:	1	2
10 MEG	OFF	ON

Tandon ROM		
62-000040-03		
DRIVE C:	1	2
10 MEG	OFF	OFF

The Tandy 1000 WD1000S-WX2 hard drive controller and the Tandy 1200 WD1002S-WX2 (short) hard drive controller appear identical but they ARE different and are NOT interchangeable. For identification purposes refer to the table listed under the note for Tandy 1000 WD1002S-WX2 controller board.

20 MEG Mitsubishi (MR522) Hard Drive Logic Board 25-4062 (figure 100):

Switch	Drive C	Drive D	Description
SW1-1	On	On	Selects daisy chain operation
SW1-2	Off	Off	Disables diagnostic operation
SW1-3	Off	Off	Drive select 4
SW1-4	Off	Off	Drive select 3
SW1-5	Off	On	Drive select 2
SW1-6	On	Off	Drive select 1

Termination is accomplished with SW2. On=Termination. Off=Not Terminated.

Switch	Last Drive	First Drive
	On Cable	On Cable
SW2-1	On	Off
SW2-2	On	Off
SW2-3	On	Off
SW2-4	On	Off
SW2-5	On	Off
SW2-6	On	Off

TANDY COMPUTER PRODUCTS

20 MEG Seagate (ST225) Hard Drive Logic Board 25-4062 (figure 101):

Only one jumper should be on.

15-16 Drive select 1

13-14 Drive select 2

11-12 Drive select 3

9-10 Drive select 4

Terminating resistor pack (220/330 ohm) should be installed

40 MEG CDC (WREN II) Hard Drive Logic Board 25-4061 (figure 110):

DSx Drive select (DS1 = C, DS2 = D)

Termination resistor pack (220/330 ohm SIP) should be installed in the last drive on the cable.

Floppy/Hard Drive WD1002-WA2 Controller Board 25-4060 (figure 95):

E2-E3 Selects primary address for floppy (standard)

E1-E2 Selects secondary address for floppy

E5-E6 Selects primary address for hard drive (standard)

E4-E5 Selects secondary address for hard drive

E7-E8 Connects floppy read data into VCO

Floppy/Hard Drive WD1003-WA2 Controller Board 25-4060 (figure 124):

E2-E3 Selects primary address for floppy (standard)

E1-E2 Selects secondary address for floppy

E5-E6 Selects primary address for hard drive (standard)

E4-E5 Selects secondary address for hard drive

E7-E8 Supports 360 RPM floppy disk drives (standard)

E8-E9 Supports 300 RPM floppy disk drives

Microscience 40 Meg (HH1050) Hard Drive Logic 25-4061 (figure 133):

SW1 positions 1-4: Drive Select

Drive	POS1	POS2	POS3	POS4	
C/0	On	Off	Off	Off	
D/1	Off	On	Off	Off	
E/2	Off	Off	On	Off	Not Supported
F/3	Off	Off	Off	On	Not Supported

SW1 positions 5-10: Termination

POS 5-10 On for the last drive on the control cable

Off for all other drives

TANDY COMPUTER PRODUCTS

Disk Cartridge Controller board (figure 73):

SW1-1 Off Manual Power-on reset
 SW1-2 Off Parity checking
 SW1-3 Off Retries enabled without startup diagnostics
 SW1-4 Off Retries enabled without startup diagnostics
 SW1-5 Off 10.0 Code enabled
 JP16 Pin0 Selects address
 JP2 All On

10 MEG IOMEGA (Alpha-10H) Disk Cartridge Drive Logic Board (figure 74):

There are 3 rows (J2, J3, J4) of seven pins. Jumper together all seven pins between rows;

J2 & J3 Selects Drive 0
 J3 & J4 Selects Drive 1

20 MEG IOMEGA (Alpha-20H) Disk Cartridge Drive Logic Board (figure 118):

There are 3 rows of seven pins used for drive select as follows:

Top Two Rows Selects Drive 0
 Bottom Two Rows Selects Drive 1

IOMega Disk Cartridge Controller 5 1/4 20Meg 25-4064 (Beta 20) (figure 150):

S1 Dip Switch

Position 1	Off	Manual Power-on Reset
Position 2	Off	Normal Operation
Position 3	Off	No parity checking
	On	Parity checking (Standard)
Position 4	Position 5	Position 6 SCSI Bus Address
Off	Off	Off 0
Off	Off	On 1
Off	On	Off 2
Off	On	On 3 (Standard)
On	Off	Off 4
On	Off	On 5
On	On	Off 6
On	On	On 7

IOMega Disk Cartridge Drive Logic 5 1/4 20 Meg (Beta 20) Primary (figure 151):

JB2 Two pins closest to the rear of the drive jumpered.

JB3 Jumpered

JB4 Two pins closest to the center of the drive jumpered.

JB1 Drive Select 0 Jumper the two rows of pins closest to LUN0 (the front of the drive) at all four positions.

Note: There is a radical difference between the Primary and Secondary 5 1/4 Disk Cartridge units. Installing two primary drives will not work.

TANDY COMPUTER PRODUCTS

IOMega Disk Cartridge Drive Logic 5 1/4 20 Meg (Beta 20) Secondary 25-4065 (figure 152):

JB1 Drive Select 1 Jumper the two rows of pins closest to LUN1 (the rear of the drive at all four positions.

Note: There is a radical difference between the Primary and Secondary 5 1/4 Disk Cartridge units. Installing two secondary drives will not work.

Disk Cartridge Interface Board for Tandy 2000 26-5147 (figure 112):

E1 On = 1 Cartridge Drive in system
Off = 2 Cartridge Drives in system

Disk Cartridge Interface Board for Tandy 1000/1200/3000 25-3022 (figure 75):

SW1 position 1 ON selects 1 drive
OFF selects 2 drives
SW1 positions 2 and 5 ON
3, 4, 6-8 OFF selects address

PC2B Disk Cartridge Interface Board for 1000/1200/3000 25-4064 (figure 111):

Port Address:	SW1	SW2	Address
	On	On	340H-345H (standard)
	Off	On	350H-355H
	On	Off	360H-365H
	Off	Off	370H-375H

DMA Channel:	SW3	Channel #
	On	1
	Off	3 (standard)

DMA/PIO Select:	SW4	Function
	On	PIO enabled
	Off	DMA enabled (standard)**

**** NOTE:** This switch should be set to the ON position, to enable PIO mode, when used in a 80386 based CPU or a Tandy 3000NL in fast mode (i.e., a clock speed of 10 MHz and above). If a SCSI hard drive controller is used, then PIO mode should also be set to the ON position. Set this switch to the OFF position for all other MS-DOS computer systems.

Reserved:	SW5	SW6	SW7
	Off	Off	Off (standard)

Number of Drives:	SW8	Drives
	Off	2 Drives in system
	On	1 Drive in system (standard)

(continued on next page)

TANDY COMPUTER PRODUCTS

The ROM/RAM address option jumpers consist of 4 sets (labeled 1 through 4) with three staking pins to a set. The following table will describe the jumpers as JP1 - upper, meaning the top two pins of JP1, and JP1 - lower meaning the lower two pins of JP1.

JP1	JP2	JP3	JP4	Address Range	
Upper	Upper	Upper	Upper	C800:0000 to C800:1FFF	
Upper	Upper	Upper	Lower	CA00:0000 to CA00:1FFF	
Upper	Upper	Lower	Upper	CC00:0000 to CC00:1FFF	
Upper	Upper	Lower	Lower	CE00:0000 to CE00:1FFF	(standard)
Upper	Lower	Upper	Upper	D000:0000 to D000:1FFF	(Xenix Operation)
Upper	Lower	Upper	Lower	D200:0000 to D200:1FFF	
Upper	Lower	Lower	Upper	D400:0000 to D400:1FFF	
Upper	Lower	Lower	Lower	D600:0000 to D600:1FFF	
Lower	Upper	Upper	Upper	D800:0000 to D800:1FFF	
Lower	Upper	Upper	Lower	DA00:0000 to DA00:1FFF	
Lower	Upper	Lower	Upper	DC00:0000 to DC00:1FFF	
Lower	Upper	Lower	Lower	DE00:0000 to DE00:1FFF	
Lower	Lower	Upper	Upper	E000:0000 to E000:1FFF	
Lower	Lower	Upper	Lower	E200:0000 to E200:1FFF	
Lower	Lower	Lower	Upper	E400:0000 to E400:1FFF	
Lower	Lower	Lower	Lower	ROM/RAM Disabled	(for use with SCSI)

TCS-100 Tape Cartridge Controller Board 25-3020 (figure 78):

E3-E4 Along with E8-E9 selects on board RAM size to 2K

E8-E9 Selects on board RAM size to 2K

E11-E12 Test jumper (on for normal operation)

TCS-100 Tape Cartridge Drive Logic Board 25-3020 (figure 79):

HDR1-5 Selects tape drive 0

HDR3-4 Selects phase 4

HDR3-8 Selects phase 4

9/12 Selects 9 tracks

IHC

TCS-100 Tape Cartridge Drive Logic Board Revision C2 25-3020 (figure 113):

HDR1-2

HDR3-1

HDR3-5

IHC

TNG

E1

TANDY COMPUTER PRODUCTS

TCS-100 Tape Cartridge Interface Board for the 1000/1200/3000 25-3021
(figure 80):

ADDR SEL B Selects address range of 338-33B hex
 ADDR SEL D Selects address range of 338-33B hex
 ADDR SEL E Selects address range of 338-33B hex
 ADDR SEL G Selects address range of 338-33B hex
 DRQ1 (MS-DOS Operation) DRQ3 (Xenix Operation)
 DACK1 (MS-DOS Operation) DACK3 (Xenix Operation)
 IRQn Selects interrupt used. Use ONLY ONE from the table below:

	Tandy 1000	Tandy 1200	Tandy 3000/HL
IRQ7	Default LPT1	Default LPT1	Default LPT1
IRQ5	Vertical Sync	Default Hard Drive	Default LPT2
IRQ4	Default COM1	Default COM1	Default COM1
IRQ3	Default COM2	Default COM2	Default COM2
IRQ2	Default Hard Drive	Tape Standard	Tape Standard

Important Note: Only ONE of IRQ2 through IRQ7 should be on.

IRQ2 through IRQ7 select the interrupt request line the tape cartridge interface board will use. The above table shows the default uses of these interrupt lines on each machine. When selecting which interrupt to use the entire system must be taken into account. For example; on the Tandy 1000 if there is no hard drive installed then IRQ2 would be the logical choice for the tape cartridge interface board. However if the computer has a hard drive then IRQ3 or IRQ4 must be used. This means of course that the associated COM port can not be used for a serial or modem board. For use with Xenix, IRQ3 should be used. Also for use with Xenix, the correct PAL chip must be installed. Refer to Technical Bulletin I/O:108 for further information.

TANDY COMPUTER PRODUCTS

16 Bit SCSI Host Adapter 25-4161/A (figure 161): 25-4161B (figure 212):

General Notes:

There are three different versions of this board currently in use. The 25-4161 and the 25-4161A look essentially the same; the major differences are that the 25-4161 board is capable of asynchronous operation only (J1, pin pair 1 off), and has a U20 IC labeled AIC-6250. The 25-4161A board is capable of both synchronous and asynchronous operation, and is defaulted to synchronous (J1, pin pair 1 on); the U20 IC has moved up to a D-step (or revision D) part and is now labeled AIC-6250DL. The "DL" indicates that the IC is a D-step part.

The 25-4161B board is quite different from the 25-4161 and the 25-4161A. The board makes heavy use of surface mount technology, the jumpering is somewhat different, and there is an external connector to allow connection of additional external SCSI devices. This board is also capable of both synchronous and asynchronous operation, and is defaulted to synchronous (J1, pin pair 1 on).

Use of any of these boards requires that the computer have at least a BIOS version of 01.03.01 or later. If the board is being used in an MS-DOS environment, the MS-DOS version must be 3.3 or later. If the board is being used in an 80386 Xenix environment, the Xenix version must be SCO Xenix/386 version 2.2.4 or later.

There are several different versions of BIOS and firmware for these adapters. For the most current information, refer to Technical Bulletin HD:51. Two items to be aware of are:

- (1) For a SCSI hard drive of size greater than 255 megs to be used in an MS-DOS environment, a SCSI BIOS and firmware of version 5.xx must be used. (The "x" indicates that there may be more than one version available.
- (2) To use SCO Xenix/386 version 2.2.4, a SCSI BIOS version of 2.x or 4.xx must be used. SCO Xenix/386 version 2.2.4 will not work with a SCSI BIOS and firmware of 5.xx.

NOTE: In the following jumper listings, R-->L refers to the counting of that jumper block starting from the right and going to the left. Conversely, L-->R would indicate counting starts from the left and goes to the right. Also, T-->B indicates that the counting of that jumper block starts from the top and counts towards the bottom of the board.

(continued on next page)

TANDY COMPUTER PRODUCTS

Jumpers for the 25-4161 and 25-4161A:**For use in Tandy 4000/4000LX:**

J1, pin pair 1	L-->R	25-4161 -- off (normal configuration). Turns off synchronous negotiation initiation. 25-4161A -- on (normal configuration). Turns on synchronous negotiation initiation.
J1, pin pair 2		off (normal configuration). Reserved.
J1, pin pair 3		off (normal configuration). Parity checking enabled.
J1, pin pair 4		off \
J1, pin pair 5		off -- SCSI address 7 (normal configuration).
J1, pin pair 6		off /
J1, pin pair 7		off \
J1, pin pair 8		on / DMA channel 5 (normal configuration).
J1, pin pair 9		off \
J1, pin pair 10		on -- Interrupt channel 11 (normal configuration).
J1, pin pair 11		off /
RN6, RN7		installed (normal configuration). SCSI terminators.
F1		installed (normal configuration). Host adapter provides terminator power.
J4		off (normal configuration) No wait states on BIOS access.
J5		off (normal configuration for 4000/4000LX). Computer type jumper.
J6, pin pair 1	R-->L	off \
J6, pin pair 2		on -- DMA Request 5 (normal configuration).
J6, pin pair 3		off
J6, pin pair 4		off /
J7, pin pair 1	R-->L	off \
J7, pin pair 2		on -- DMA ACKnowledge 5 (normal configuration).
J7, pin pair 3		off
J7, pin pair 4		off /
J8, pin pair 1	R-->L	off \
J8, pin pair 2		off
J8, pin pair 3		on -- Interrupt channel 11 (normal configuration).
J8, pin pair 4		off
J8, pin pair 5		off
J8, pin pair 6		off /

(continued on next page)

TANDY COMPUTER PRODUCTS

J9, pin pair 1 L-->R on \
 J9, pin pair 2 on |
 J9, pin pair 3 off |
 J9, pin pair 4 off |-- Port address 0330h (normal configuration).
 J9, pin pair 5 on |
 J9, pin pair 6 on |
 J9, pin pair 7 off |
 J9, pin pair 8 off /

J10, pin pair 1 off \
 J10, pin pair 2 off |-- BIOS address 0DC000h (normal configuration).
 J10, pin pair 3 off /

For use in Tandy 3000/3000-12/3000NL/4000SX:

The jumpers are the same as those for the Tandy 4000/4000LX except for:

J5 on (normal configuration for non-4000/4000LX installation). Computer type jumper.

For use in Tandy 3000HL:

The jumpers are the same as those for the Tandy 4000/4000LX except for:

J1, pin pair 7 L-->R on \ DMA channel 0 (normal 3000HL configuration).
 J1, pin pair 8 on /

J5 on (normal configuration for non-4000/4000LX installation). Computer type jumper.

J6, pin pair 1 R-->L on \
 J6, pin pair 2 off |-- DMA Request 0 (normal 3000HL configuration).
 J6, pin pair 3 off |
 J6, pin pair 4 off /

J7, pin pair 1 R-->L on \
 J7, pin pair 2 off |-- DMA ACKnowledge 0 (normal 3000HL
 J7, pin pair 3 off | configuration).
 J7, pin pair 4 off /

(continued on next page)

Complete Jumper Information:

Normal configurations for installation have been given in the above listings. Complete jumper information is as follows:

SCSI Address:

Set by jumper set J1, pin pairs 4, 5, and 6.

Jumper Pair			SCSI
4	5	6	Address
on	on	on	Ø
off	on	on	1
on	off	on	2
off	off	on	3
on	on	off	4
off	on	off	5
on	off	off	6
off	off	off	7

SCSI Parity:

Set by jumper set J1, pin pair 3. A jumper installed on this position disables parity; no jumper enables parity.

SCSI Terminators and Terminator Power:

RN6 and RN7 are the SCSI terminators. If the host adapter is not the first or the last SCSI device in a string of SCSI devices, or if inline terminators are used, then RN6 and RN7 must be removed. Otherwise, they must be installed.

F1 controls the terminator power. If another SCSI device is supplying terminator power, then F1 may optionally be removed. No more than 5 SCSI devices should be configured to supply terminator power to a single SCSI bus.

SCSI Synchronous Negotiation:

Jumper set J1, pin pair 1, is the synchronous negotiation enable jumper. The host adapter will initiate SCSI synchronous negotiation during initialization or after a SCSI reset if this jumper is installed. If the jumper is not installed, the host adapter will still support synchronous SCSI transfers, but the target must initiate the negotiation. (Synchronous operation is not supported on the 25-4161, and is supported on the 25-4161A).

(continued on next page)

TANDY COMPUTER PRODUCTS

DMA Channel Selection:

Three jumper blocks (J1, pin pairs 7 and 8, J6, and J7) are used in DMA channel selection. Configuration is as follows:

J1:	Jumper Pair		DMA		
	7	8	Channel		
	on	on	Ø		
	off	on	5		
	on	off	6		
	off	off	7		
J6:	Jumper Pair				DMA
	1	2	3	4	Request
	on	off	off	off	Ø
	off	on	off	off	5
	off	off	on	off	6
	off	off	on	7	
J7:	Jumper Pair				DMA
	1	2	3	4	Acknowledge
	on	off	off	off	Ø
	off	on	off	off	5
	off	off	on	off	6
	off	off	on	7	

Interrupt Channel:

Two jumper blocks (J1, pin pairs 9, 1Ø, and 11, and J8) are used in determining interrupt selection.

J1:	Jumper Pair			Interrupt			
	9	1Ø	11	Channel			
	on	on	on	not defined			
	off	on	on	not defined			
	on	off	on	15			
	off	off	on	14			
	on	on	off	12			
	off	on	off	11			
	on	off	off	1Ø			
		off	off	9			
J8:	Jumper Pair						Interrupt
	1	2	3	4	5	6	Channel
	on	off	off	off	off	off	9
	off	on	off	off	off	off	1Ø
	off	off	on	off	off	off	11
	off	off	off	on	off	off	12
	off	off	off	off	on	off	14
	off	off	off	off	on	15	

(continued on next page)

Port Address:

The starting port address of the block of four I/O ports required by the host adapter is set by jumper block J9.

J9:	Jumper Pair		Port I/O Address Bit
LSB	1		004h
	2		008h
	3		010h
	4		020h
	5		040h
	6		080h
	7		100h
MSB	8		200h

The bits set by these jumpers are additive. For example, to arrive at a port address of 0330h, one should have jumpers installed on J9, pin pairs 3, 4, 7, and 8 (010h + 020h + 100h + 200h = 330h).

BIOS Address:

The starting address of the block of address space reserved for the BIOS is selected by jumper block J10. The address chosen must not conflict with any other BIOS in the system.

J10:	Jumper Pair			BIOS
	1	2	3	Address
	on	on	on	0C0000h
	off	on	on	0D0000h
	on	off	on	0C8000h
	off	off	on	0D8000h
	on	on	off	0C4000h
	off	on	off	0D4000h
	on	off	off	0CC000h
	off	off	off	0DC000h

BIOS Wait State:

The J4 jumper determines whether or not one wait state will be added during BIOS access. No jumper installed sets 0 wait states; installation of the jumper sets one wait state for BIOS access.

Reserved Jumper:

J1, pin pair 2 is a reserved jumper and should never be installed.

(continued on next page)

TANDY COMPUTER PRODUCTS

Computer Configuration Jumper:

J5 should be off for use in a Tandy 4000/4000LX system. It should be on for use in a Tandy 3000/3000-12/3000HL/3000NL/4000SX system.

Jumpers for the 25-4161B:**For use in Tandy 4000/4000LX/3000/3000-12/3000NL/4000SX:**

J1, pin pair 1 T-->B on (normal configuration). Turns on synchronous negotiation initiation.
 J1, pin pair 2 off (normal configuration). Reserved.
 J1, pin pair 3 off (normal configuration). Parity checking enabled.
 J1, pin pair 4 off \
 J1, pin pair 5 off |-- SCSI address 7 (normal configuration).
 J1, pin pair 6 off /
 J1, pin pair 7 off \
 J1, pin pair 8 on / DMA channel 5 (normal configuration).
 J1, pin pair 9 off \
 J1, pin pair 10 on |-- Interrupt channel 11 (normal configuration).
 J1, pin pair 11 off /
 J1, pin pair 12 off \
 J1, pin pair 13 off /

 RN3, RN4, RN5 installed (normal configuration). SCSI terminators.
 F1 installed (normal configuration). Host adapter provides terminator power.

 J6, pin pair 1 R-->L on \
 J6, pin pair 2 off |-- Port address 0330h (normal configuration).
 J6, pin pair 3 off /

 J7, pin pair 1 R-->L on \
 J7, pin pair 2 off |-- (normal configuration) No wait states on BIOS
 J7, pin pair 3 off ! access.
 J7, pin pair 4 off /

 J9, pin pair 1 off Auto request sense enabled (normal configuration)
 J9, pin pair 2 off reserved
 J9, pin pair 3 off reserved
 J9, pin pair 4 off reserved

 J10, pin pair 1 off \
 J10, pin pair 2 off / BIOS address 0DC000h (normal configuration).

 J11 on BIOS enabled (normal configuration).

(continued on next page)

TANDY COMPUTER PRODUCTS

J14, pin pair 1 R-->L off \
 J14, pin pair 2 on !-- DMA Request 5 (normal configuration).
 J14, pin pair 3 off !
 J14, pin pair 4 off /

 J15, pin pair 1 R-->L off \
 J15, pin pair 2 on !-- DMA ACKnowledge 5 (normal configuration).
 J15, pin pair 3 off !
 J15, pin pair 4 off /

 J16, pin pair 1 R-->L off \
 J16, pin pair 2 off !
 J16, pin pair 3 on !-- Interrupt channel 11 (normal configuration).
 J16, pin pair 4 off !
 J16, pin pair 5 off !
 J16, pin pair 6 off /

For use in Tandy 3000HL:

The jumpers are the same as those for the Tandy
 4000/4000LX/3000/3000-12/3000NL/4000SX except for:

J1, pin pair 7 T-->B on \
 J1, pin pair 8 on / DMA channel 0 (normal 3000HL configuration).

 J14, pin pair 1 R-->L on \
 J14, pin pair 2 off !-- DMA Request 0 (normal 3000HL configuration).
 J14, pin pair 3 off !
 J14, pin pair 4 off /

 J15, pin pair 1 R-->L on \
 J15, pin pair 2 off !-- DMA ACKnowledge 0 (normal 3000HL
 J15, pin pair 3 off ! configuration).
 J15, pin pair 4 off /

(continued on next page)

Complete Jumper Information:

Normal configurations for installation have been given in the above listings. Complete jumper information is as follows:

SCSI Address:

Set by jumper set J1, pin pairs 4, 5, and 6.

Jumper Pair			SCSI
4	5	6	Address
on	on	on	Ø
off	on	on	1
on	off	on	2
off	off	on	3
on	on	off	4
off	on	off	5
on	off	off	6
off	off	off	7

SCSI Parity:

Set by jumper set J1, pin pair 3. A jumper installed on this position disables parity; no jumper enables parity.

SCSI Terminators and Terminator Power:

RN3, RN4, and RN5 are the SCSI terminators. If the host adapter is not the first or the last SCSI device in a string of SCSI devices, or if inline terminators are used, then RN3, RN4 and RN5 must be removed. Otherwise, they must be installed.

F1 controls the terminator power. If another SCSI device is supplying terminator power, then F1 may optionally be removed. No more than 5 SCSI devices should be configured to supply terminator power to a single SCSI bus.

SCSI Synchronous Negotiation:

Jumper set J1, pin pair 1, is the synchronous negotiation enable jumper. The host adapter will initiate SCSI synchronous negotiation during initialization or after a SCSI reset if this jumper is installed. If the jumper is not installed, the host adapter will still support synchronous SCSI transfers, but the target must initiate the negotiation.

(continued on next page)

TANDY COMPUTER PRODUCTS

DMA Channel Selection:

Three jumper blocks (J1, pin pairs 7 and 8, J14, and J15) are used in DMA channel selection. Configuration is as follows:

J1:	Jumper Pair		DMA		
	7	8	Channel		
	on	on	Ø		
	off	on	5		
	on	off	6		
	off	off	7		
J14:	Jumper Pair				DMA
	1	2	3	4	Request
	on	off	off	off	Ø
	off	on	off	off	5
	off	off	on	off	6
	off	off	on	7	
J15:	Jumper Pair				DMA
	1	2	3	4	Acknowledge
	on	off	off	off	Ø
	off	on	off	off	5
	off	off	on	off	6
	off	off	on	7	

Interrupt Channel:

Two jumper blocks (J1, pin pairs 9, 1Ø, and 11, and J16) are used in determining interrupt selection.

J1:	Jumper Pair			Interrupt			
	9	1Ø	11	Channel			
	on	on	on	not defined			
	off	on	on	not defined			
	on	off	on	15			
	off	off	on	14			
	on	on	off	12			
	off	on	off	11			
	on	off	off	1Ø			
	off	off	9				
J16:	Jumper Pair						Interrupt
	1	2	3	4	5	6	Channel
	on	off	off	off	off	off	9
	off	on	off	off	off	off	1Ø
	off	off	on	off	off	off	11
	off	off	off	on	off	off	12
	off	off	off	off	on	off	14
off	off	off	off	off	on	15	

(continued on next page)

Port Address:

The starting port address of the block of four I/O ports required by the host adapter is set by jumper block J6. The port address is coded in the BIOS ROM and must match it; therefore the port address cannot be changed unless a new BIOS ROM is installed.

J6:	Jumper Pair			Port I/O Address
	1	2	3	
	off	off	off	334h
	on	off	off	330h
	off	on	off	234h
	on	on	off	230h
	off	off	on	134h
	on	off	on	130h

BIOS Address:

The starting address of the block of address space reserved for the BIOS is selected by jumper block J10. The address chosen must not conflict with any other BIOS in the system.

J10:	Jumper Pair		BIOS Address
	1	2	
	on	on	0C8000h
	off	on	0D8000h
	on	off	0CC000h
	off	off	0DC000h

BIOS Wait State:

The J7 jumper block determines whether or not wait states will be added during BIOS access.

J7:	Jumper Pair				Wait State
	1	2	3	4	
	on	off	off	off	disabled
	off	on	off	off	100 nsec
	off	off	on	off	200 nsec
	off	off	off	on	300 nsec

Reserved Jumpers:

J1, pin pair 2 is a reserved jumper and should never be installed. J9, pin pairs 2, 3, and 4 are reserved jumpers and should never be installed.

(continued on next page)

DMA Transfer Speed Default:

Pin-pairs 12 and 13 of jumper block J1 set the default DMA transfer speed. The default speed is selected after power on or after a hard reset occurs.

J1:	Jumper Pair		DMA Speed
	12	13	
	off	off	5.0 Mbyte/sec
	on	off	5.7 Mbyte/sec
	off	on	6.7 Mbyte/sec
	on	on	8.0 Mbyte/sec

Auto Request Sense:

J9, pin pair 1 determines whether auto request sense is enabled or disabled. If a jumper is installed, auto request sense is disabled. If no jumper is installed, auto request sense is enabled.

BIOS Enable/Disable:

J11 determines whether the SCSI BIOS is enabled or disabled. If a jumper is installed, the BIOS is enabled. If no jumper is installed, the BIOS is disabled.

40 MEG SCSI Hard Drive 25-4159 (figure 162):

This drive is a 3.5 inch Quantum ProDrive 40S. Jumpering is as follows:

Primary Drive: A jumper should be installed on EP, and the drive should be installed at the end of the SCSI cable. Termination resistor packs (220/330 8 pin SIP) should be installed at RN201, RN202, and RN203.

Secondary Drive: Jumpers should be installed on A0 and EP, and the drive should be installed on the middle connector of the SCSI cable. Termination resistor packs (220/330 8 pin SIP) at RN201, RN202, and RN203 should not be installed.

(continued on next page)

Detailed information on the jumpers is:

A0 off (normal configuration for primary) \
 on (normal configuration for secondary) !-- SCSI Bus ID
 A1 off (normal configuration) /
 A2 off (normal configuration)

Of the A2, A1, and A0 jumpers, A2 is the most significant bit, and A0 the least. Jumper installation represents a 1, meaning that with all three jumpers off, the device is identified as SCSI ID 0. All three jumpers on yields a SCSI ID of 7.

WS off (normal configuration). Wait Spin jumper determines whether the drive will immediately apply power to the motor at power-up. If the jumper is installed, the motor in the drive will not start spinning until the host sends a start/stop command across the SCSI bus.

EP on (normal configuration). Enable Parity jumper when installed enables parity checking.
 SS off (normal configuration). Self Seek when installed causes the drive to perform random seeks for test purposes.

80 MEG SCSI Hard Drive 25-4160 (figure 163):

This drive is a half-height 5.25 inch Quantum Q280 drive. Jumpering is as follows:

Primary Drive: Jumpers installed at EP and P1, with drive installed at the end of the SCSI cable and terminators installed at U31, U32, and U33.

Secondary Drive: Jumpers installed at EP, P1, and A0, with drive installed at the middle of the SCSI cable and terminators removed from positions U31, U32, and U33.

Detailed information on the jumpers are:

A0 off (normal configuration for primary) \
 on (normal configuration for secondary) !-- SCSI Bus ID
 A1 off (normal configuration) /
 A2 off (normal configuration)

Of the A2, A1, and A0 jumpers, A2 is the most significant bit, and A0 the least. Jumper installation represents a 1, meaning that with all three jumpers off, the device is identified as SCSI ID 0. All three jumpers on yields a SCSI ID of 7.

(continued on next page)

TANDY COMPUTER PRODUCTS

WS off (normal configuration). Wait Spin jumper determines whether the drive will immediately apply power to the motor at power-up. If the jumper is installed, the motor in the drive will not start spinning until the host sends a start/stop command across the SCSI bus.

EP on (normal configuration). Enable Parity jumper when installed enables parity checking.

SS off (normal configuration). Self Seek when installed causes the drive to perform random seeks for test purposes.

RO off (normal configuration). Reset Option determines behavior of the drive upon receipt of a SCSI RST command.

P1 on (normal configuration). Spare Jumper is a spare which affects nothing on the board.

80 MEG SCSI Hard Drive 25-4160A (figure 162):

This drive is a 3.5 inch Quantum ProDrive 80S. Jumpering is as follows:

Primary Drive: A jumper should be installed on EP, and the drive should be installed at the end of the SCSI cable. Termination resistor packs should be installed at RN201, RN202, and RN203.

Secondary Drive: Jumpers should be installed on A0 and EP, and the drive should be installed on the middle connector of the SCSI cable. The termination resistor packs at RN201, RN202, and RN203 should not be installed.

Detailed information on the jumpers is:

A0	off (normal configuration for primary)	\
	on (normal configuration for secondary)	!-- SCSI Bus ID
A1	off (normal configuration)	/
A2	off (normal configuration)	

Of the A2, A1, and A0 jumpers, A2 is the most significant bit, and A0 the least. Jumper installation represents a 1, meaning that with all three jumpers off, the device is identified as SCSI ID 0. All three jumpers on yields a SCSI ID of 7.

WS off (normal configuration). Wait Spin jumper determines whether the drive will immediately apply power to the motor at power-up. If the jumper is installed, the motor in the drive will not start spinning until the host sends a start/stop command across the SCSI bus.

EP on (normal configuration). Enable Parity jumper when installed enables parity checking.

SS off (normal configuration). Self Seek when installed causes the drive to perform random seeks for test purposes.

170 MEG SCSI Hard Drive 25-4162 (figure 164):

This is a 5.25 inch half height drive. Jumpering is:

Primary drive: Parity Check jumper installed, Termination Power jumper in position B, no drive select bit jumpers installed, three termination resistors installed on small termination PCB near power connector.

Secondary drive: Parity Check jumper installed, Termination Power jumper in position B, drive select jumper bit 1 installed, termination resistors removed from small termination PCB near power connector.

Detailed jumpering information is:

Drive Selects:

Bit 1	off (normal configuration for primary) \	
	on (normal configuration for secondary) !--	SCSI Bus ID
Bit 2	off (normal configuration)	/
Bit 4	off (normal configuration)	

Of the Bit 4, Bit 2, and Bit 1 jumpers, Bit 4 is the most significant bit, and Bit 1 the least. Jumper installation represents a 1, meaning that with all three jumpers off, the device is identified as SCSI ID 0. All three jumpers on yields a SCSI ID of 7.

Motor Start	off (normal configuration).	Motor Start jumper determines whether the drive will immediately apply power to the motor at power-up. If the jumper is installed, the motor in the drive will not start spinning until the host sends a start/stop command across the SCSI bus.
Parity Check	on (normal configuration).	Parity Check jumper when installed enables parity checking.
Test Seek	off (normal configuration).	Test Seek when installed causes the drive to perform random seeks for test purposes.
Terminator PWR	Position B (normal configuration).	This jumper selects the source of terminator power. Position A causes terminator power to be supplied from the drive power connector; Position B causes terminator power to be provided by the interface; Position C the drive will provide terminator power to pin 26 of the SCSI cable. If Position C is used, Position A should also be jumpered.

TANDY COMPUTER PRODUCTS

344 MEG SCSI Hard Drive 25-4163 (figure 165):

This is a 5.25 inch full height drive. Jumpering is:

Primary drive: Parity Check jumper installed, termination power jumper in horizontal position, no drive select bit jumpers installed, two termination resistors installed at U53 and U54. Jumpers installed at J3, pins 1-2, and pins 3-4.

Secondary drive: Parity Check jumper installed, Termination Power jumper in horizontal position, drive select jumper bit 1 installed, termination resistors removed from U53 and U54. Jumpers installed at J3, pins 1-2, and pins 3-4.

Detailed jumpering information is:

Drive Selects:

Bit 1	off (normal configuration for primary) \	
	on (normal configuration for secondary)	-- SCSI Bus ID
Bit 2	off (normal configuration)	/
Bit 4	off (normal configuration)	

Of the Bit 4, Bit 2, and Bit 1 jumpers, Bit 4 is the most significant bit, and Bit 1 the least. Jumper installation represents a 1, meaning that with all three jumpers off, the device is identified as SCSI ID 0. All three jumpers on yields a SCSI ID of 7.

Motor Start	off (normal configuration). Motor Start jumper determines whether the drive will immediately apply power to the motor at power-up. If the jumper is installed, the motor in the drive will not start spinning until the host sends a start/stop command across the SCSI bus.
Parity Check	on (normal configuration). Parity Check jumper when installed enables parity checking.
Terminator PWR	horizontal position (normal configuration). The horizontal position causes terminator power to be supplied by the interface; the vertical position causes the drive to supply terminator power.
Ground Select	J3, jumpers installed on pins 1-2, and 3-4 (normal configuration). This ties AC and DC grounds together and connects them to chassis ground.

TANDY COMPUTER PRODUCTS

ST506 WD1003-WAH Hard Drive Only Controller Board 25-4058 (figure 166):

For Tandy 3000/4000 families.

Jumper	Position
W1	No Jump
W2	No Jump
W3	No Jump
W4	Jump 2 to 3
W5	Jump 2 to 3
W6	Jump 2 to 3

Detailed jumpering is as follows;

- W1 NO JUMPER - Standard factory setting. Status Read is non-latched. Dynamic drive select; i.e., SELECT = DRIVE BUSY.
 JUMPER - Status read is latched. Static drive select; i.e., SELECT asserted except during RESET.
- W2 NO JUMPER - Standard factory setting. Primary addresses selected.
 JUMPER - Secondary addresses selected.
- W3 NO JUMPER - This configuration used with WD11C00A-22 or when W5, pins 2 and 3 are jumpered.
 JUMPER - Required on early units with WD11C00-22 and W5, pins 1 and 2 are jumpered.
- W4 JUMPER 2-3 Standard factory setting - ties FIRMWARE sense bit input high
 JUMPER 1-2 Supports 2 head, 612 cylinder second drive with standard system setup for 4 head, 306 cylinder drive.
- W5 JUMPER 2-3 Standard factory setting
 JUMPER 1-2 Internal signal of power-up circuit controls WG* enable.
- W6 JUMPER 2-3 Standard factory setting. Ties input high.
 JUMPER 1-2 Ties input low. The 35 usec step rate cannot be selected with W6 in this position. Instead, the 16 usec step rate is selected.

Seagate ST-251 40MEG 5 1/4" ST-506 Hard Drive 25-4057 (figure 167):**DSx Jumper:**

The first four pins are used for drive select. Starting from the left, they are DS1, DS2, DS3, DS4. Jumper only one. The last three pairs of pins are left unjumpered.

Termination resistor pack (220/330 ohm 9-pin SIP) should be installed in the last drive on the cable.

TANDY COMPUTER PRODUCTS

40 MEG Rodime RO-3055 3 1/2" ST506 Hard Drive 25-4061A (figure 168):

DSx Jumper:

Starting from the left, the drive select pins are DS1, DS2, DS3, DS4.
Jumper only one.

Termination resistor pack (220/330 ohm 8-pin SIP) should be installed in the last drive on the cable.

70 MEG Rodime RO-5090 5 1/4" ST506 Hard Drive 25-4067 (figure 169):

DSx Jumper:

Starting from the left, the drive select pins are DS1, DS2, DS3, DS4.
Jumper only one.

Termination resistor pack (220/330 ohm 8-pin SIP) should be installed in the last drive on the cable.

40 MEG 3 1/2" Seagate ST-151 ST506 Hard Drive 25-4140 (figure 170):

DSx Jumper JP7 Note: Terminator installed on last drive.

1	15-16
2	13-14
3	11-12
4	9-10

TEST 7-8 (not used)

RADIAL 1-2 (not used)
3-4 (not used)
5-6 (not used)

80 MEG CDC 94355 3 1/2" ST506 Hard Drive for 5000MC 25-4141 (figure 171):

DSx Jumper-J7 Note: Terminator installed on last drive.
This drive is a Swift 94355-100, and
is rated at 16.5 mS, MFM, and 17 sectors.

1	1-2
2	3-4
3	5-6
4	7-8

RADIAL 9-10 (not used)

SPINDLE 11-12 (not used)
CLK.

16 Bit SCSI-MC5000 Hard Drive Controller 25-6060 (figure 172):

RN2 and RN3 are the SCSI terminators. If the host adapter is not the first or the last SCSI device in a string of SCSI devices, or if inline terminators are used, then RN2 and RN3 must be removed. Otherwise, they must be installed. Fuse F1 should be installed. There are no jumpers for this board.

ST506-MC5000 Hard Drive Controller 25-6040 (figure 173 and 265):

There are two versions of this board. The first version is a Western Digital WD1006V-MC1. It has no jumpers. The control cable connects to J1. The primary drive data cable connects to J3. The secondary drive data cable connects to J2. Refer to owners manual for installation instructions and figure 173 for visual reference.

The second version is made by Adaptec. While there are several connectors on this board, the only ones used are J1 for the control cable, J3, and J2; J3 for the primary drive data cable and J2 for the secondary drive data cable. Test point 1 is used for factory testing. Refer to figure 265 for visual reference.

20 MEG CMS (1400 LT) 3 1/2" Hard Drive 25-3515 (figure 174):**20 MEG CMS (1400 LT) 3 1/2" Hard Drive Controller 25-3515 (figure 175):**

This drive has no jumpers or drive select. There are also no jumpers or switches on the controller board. Installation is straight forward. It should be used with MS-DOS version 03.20.04. Refer to Technical Bulletin PORTABLES:2 for detailed installation instructions. Be SURE that the hard drive controller power cable has a fuse in series with a current limiting resistor paralleled with a diode in line between the power supply and the battery. Without these components, extensive battery damage WILL occur.

The adapter that comes with this kit must be used once the hard drive is installed, as the original AC adapter does not supply enough current to the hard drive. Also, due to a manufacturing difference between the 1400LT and 1400FD the power supplies used are NOT compatible between machines. For more information on adapters see Technical Bulletin PORTABLES:4.

DOS version 03.20.04 comes with a RAMDISK option installing as a C: drive. This will interfere with the PREP.EXE program which performs a low level format. Make sure to rename the CONFIG.SYS and AUTOEXEC.BAT files temporarily in order to allow PREP.EXE to format properly. If you do not allow for this, an "Invalid Partition" message will occur after the low level formatting.

Parts that come in the kit:

- (1) hard disk drive
- (1) controller card

(continued on next page)

TANDY COMPUTER PRODUCTS

- (1) LiteDrive utilities disk
- (3) plastic hex nuts (usually on the drive)
- (1) AC adapter (15V @ 1600 mAH)

*The control and power cables will be attached to the controller card.

20 Meg (1400FD) 3 1/2" Hard Drive Kit 25-3516 (figure 234):

This drive has one set of three jumpers for factory testing on the left hand side of the drive (facing the drive indicator light). The three jumpers are set from the factory as follows and should not be changed:

DMW	Jumped	Wait Mode 1 Enabled
WM2	Jumped	Wait Mode 2 Enabled (Spindle Motor OFF)
AG	Not jumped	Aging Test (Factory test mode)

There are no jumpers or switches on the controller board. Installation is straight forward. It should be used with MS-DOS 3.30.00. Detailed instructions are in the hard drive installation guide.

The adapter that comes with this kit must be used once the hard drive is installed, as the original AC adapter does not supply enough current to the hard drive. Also, due to a manufacturing difference between the 1400LT and 1400FD the power supplies used are NOT compatible between machines. For more information on adapters see Technical Bulletin PORTABLES:4.

Parts that come in the kit:

(1) Hard Disk Controller Connector	(1) Plastic Spacer
(1) Hard Disk Controller Card	(3) Screws
(1) Hard Disk Drive	(1) Fan
(2) HDD Mounting Bracket	(1) AC Adapter
(1) RF shield	(1) Bad Sector Label
(1) Hard Disk Controller Cable	

Western Digital Hard Card Controller WD1002A-WX1 (figure 134):

The controller card is a WD1002A-WX1 type from Western Digital. It comes jumpered for a Tandy 1000/A/SX/TX. Jumpering of this board needs to be checked and jumpered according to the computer it is to be installed into.

W3	jumped	Enable 64k BIOS ROM
W4	2-3	I/O port 320
W5	not used	Trace between 1 and 2 is installed
W6	1-2*	RWC Disable
W7	2-3	IRQ 2, S1-7 must be on
W8	2-3	BIOS address C8000Hex.

(continued on next page)

TANDY COMPUTER PRODUCTS

S1-1** Jumper installed
 S1-2** Jumper installed
 S1-7 IRQ 2, W7 must be jumped 2-3

For a 3000 series or 4000 series computer the correct setting is given below.

For a 1200 or 1000SL/TL series the jumpers are the same as the 3000/4000 series except that S1-8 should be open (not jumped).

W3 jumped Enable 64k BIOS ROM
 W4 2-3 I/O port 320
 W5 not used Trace between 1 and 2 is installed
 W6 1-2* RWC Disable
 W7 1-2 IRQ 5, S1-7 must be off
 W8 2-3 BIOS address C8000Hex.

S1-1** Jumper installed
 S1-2** Jumper installed
 S1-8 3000/4000 host computer (On = AT BUS Off = XT BUS).

In the 3000/4000 series computers only, when a second hard card is to be installed, jumper the second controller card according to the text above with the following exceptions:

W4 1-2 On I/O port 324
 W8 1-2 On BIOS address CA000Hex

* The W6 jumper should be set 1-2. Some of the hard card controller boards will not have W6 jumper staking pins on the board. On these boards W6 was not necessary. DO NOT add a jumper to these boards.

** NOTE: The settings for S1-1 and S1-2 are as follows (CLOSED refers to the jumper installed and OPEN refers to the jumper removed):

S1-1	S1-2	HEADS	CYLINDERS
CLOSED	CLOSED	4	612
OPEN	CLOSED	4	306
CLOSED	OPEN	2	615
OPEN	OPEN	4	615

TANDY COMPUTER PRODUCTS

20 MEG Hard Card 25-1029**Fuji 3 1/2 inch 20 Meg Hard Drive FK 302-26/305-26 (figure 147):**

The Fuji Drive has 612 cylinders, 4 heads and will have one of two different style logic boards. Both styles will be discussed under this heading.

Style One:

Four Position Dip Switch (Drive Select)

Positions 1-3 Off

Position 4 On (DS1)

Eight Position Dip Switch (Termination)

Positions 1-8 On

Style Two:

Row of 4 pins located on same side of drive as the stepper motor and J2.

1 On DS1

2-4 Off

Termination Resistor pack must be installed.

The controller card is a WD1002A-WX1 type from Western Digital. It comes jumpered for a Tandy 1000/A/SX/TX. Jumpering of this board needs to be checked and jumpered according to the computer it is to be installed into.

W3 jumped	Enable 64k BIOS ROM
W4 2-3	I/O port 320
W5 not used	Trace between 1 and 2 is installed
W6 1-2*	RWC Disable
W7 2-3	IRQ 2, S1-7 must be on
W8 2-3	BIOS address C8000Hex.

S1-1**	Jumper installed
S1-2**	Jumper installed
S1-7	IRQ 2, W7 must be jumped 2-3

For a 3000 series or 4000 series computer the correct setting is given below.

For a 1200 or 1000SL/TL series the jumpers are the same except that S1-8 should be open (not jumped).

W3 jumped	Enable 64k BIOS ROM
W4 2-3	I/O port 320
W5 not used	Trace between 1 and 2 is installed
W6 1-2*	RWC Disable
W7 1-2	IRQ 5, S1-7 must be off
W8 2-3	BIOS address C8000Hex.

(continued on next page)

TANDY COMPUTER PRODUCTS

S1-1** Jumper installed
 S1-2** Jumper installed
 S1-8 3000/4000 host computer (On = AT BUS Off = XT BUS).

In the 1000 series computers, two hard cards are not supported.

In the 3000/4000 series computers only, when a second hard card is to be installed, jumper the second controller card according to the text above with the following exceptions:

W4 1-2 On I/O port 324
 W8 1-2 On BIOS address CA000Hex

* The W6 jumper should be set 1-2. Some of the hard card controller boards will not have W6 jumper staking pins on the board. On these boards W6 was not necessary. DO NOT add a jumper to these boards.

** NOTE: The settings for S1-1 and S1-2 are as follows (CLOSED refers to the jumper installed and OPEN refers to the jumper removed):

S1-1	S1-2	HEADS	CYLINDERS
CLOSED	CLOSED	4	612
OPEN	CLOSED	4	306
CLOSED	OPEN	2	615
OPEN	OPEN	4	615

20 MEG Hard Card 25-1029A/B (figures 148, 176, and 262):

The 25-1029B hard card has the same bubble as the 25-1029A hard card. It is a MiniScribe 8438 and has 615 cylinders and 4 heads. The bubble came with a shipping bracket that is taped to the stepper arm to prevent it from moving from the parked position. The correct BIOS ROM is 62-000094-030 or 62-000094-060.

The terminator is an 8 pin sip 220/330 ohms right behind the 34 pin control cable connector on the drive logic board. Drive select jumpers on the drive logic board are behind the 20 pin data cable. The one closest to the center and marked "1" is correct. There are 3 different versions of the logic board, given as follows (these jumpers should not be changed):

<u>VERSION 1 (figure 176)</u>	<u>VERSION 2 (figure 148)</u>	<u>VERSION 3 (figure 262)</u>
J12 all open	J12 all open	J12 all open
J13 CB jumpered	J13 CB jumpered	J13 open
J15 jumpered	J15 jumpered	J15 closed
J17 jumpered	J19 jumpered	
J18 1-2 jumpered	J17 jumpered	
J19 open	J21 1-2 jumpered	

(continued on next page)

TANDY COMPUTER PRODUCTS

The controller card is a WD1002A-WX1 type from Western Digital. It comes jumpered for a Tandy 1000/A/SX/TX. Jumpering of this board needs to be checked and jumpered according to the computer it is to be installed into.

W3 jumped	Enable 64k BIOS ROM
W4 2-3	I/O port 320
W5 not used	Trace between 1 and 2 is installed
W6 1-2*	RWC Disable
W7 2-3	IRQ 2, S1-7 must be on
W8 2-3	BIOS address C8000Hex.

S1-1**	Jumper installed
S1-2**	Jumper installed
S1-7	IRQ 2, W7 must be jumped 2-3

For a 3000 series or 4000 series computer the correct setting is given below.

For a 1200 or 1000SL/TL series the jumpers are the same except that S1-8 should be open (not jumped).

W3 jumped	Enable 64k BIOS ROM
W4 2-3	I/O port 320
W5 not used	Trace between 1 and 2 is installed
W6 1-2*	RWC Disable
W7 1-2	IRQ 5, S1-7 must be off
W8 2-3	BIOS address C8000Hex.

S1-1**	Jumper installed
S1-2**	Jumper installed
S1-8	3000/4000 host computer (On = AT BUS Off = XT BUS).

In the 1000 series computers, two hard cards are not supported.

In the 3000/4000 series computers only, when a second hard card is to be installed, jumper the second controller card according to the text above with the following exceptions:

W4 1-2	On	I/O port 324
W8 1-2	On	BIOS address CA000Hex

* The W6 jumper should be set 1-2. Some of the hard card controller boards will not have W6 jumper staking pins on the board. On these boards W6 was not necessary. **DO NOT** add a jumper to these boards.

(continued on next page)

TANDY COMPUTER PRODUCTS

** NOTE: The settings for S1-1 and S1-2 are as follows (CLOSED refers to the jumper installed and OPEN refers to the jumper removed):

S1-1	S1-2	HEADS	CYLINDERS
CLOSED	CLOSED	4	612
OPEN	CLOSED	4	306
CLOSED	OPEN	2	615
OPEN	OPEN	4	615

20 MEG Hard Card 25-1032 (figure 177):

The 25-1032 hard card has a new bubble. It is a Tandon TM362 and has 615 cylinders and 4 heads. The correct BIOS ROM is 62-000094-030 or 62-000094-060.

The terminator is an 8 pin sip 220/330 ohms right behind the 34 pin control cable connector on the drive logic board. Pin 1 is toward the outside. Drive select jumpers on the drive logic board are behind the 20 pin data cable. The one closest to the center is W1.

The controller card is a WD1002A-WX1 type from Western Digital. It comes jumpered for a Tandy 1000/A/SX/TX. Jumpering of this board needs to be checked and jumpered according to the computer it is to be installed into.

W3 jumped	Enable 64k BIOS ROM
W4 2-3	I/O port 320
W5 not used	Trace between 1 and 2 is installed
W6 1-2*	RWC Disable
W7 2-3	IRQ 2, S1-7 must be on
W8 2-3	BIOS address C8000Hex.
S1-1**	Jumper installed
S1-2**	Jumper installed
S1-7	IRQ 2, W7 must be jumped 2-3

For a 3000 series or 4000 series computer the correct setting is given below.

For a 1200 or 1000SL/TL series the jumpers are the same except that S1-8 should be open (not jumped).

W3 jumped	Enable 64k BIOS ROM
W4 2-3	I/O port 320
W5 not used	Trace between 1 and 2 is installed
W6 1-2*	RWC Disable
W7 1-2	IRQ 5, S1-7 must be off
W8 2-3	BIOS address C8000Hex.

(continued on next page)

TANDY COMPUTER PRODUCTS

S1-1** Jumper installed
 S1-2** Jumper installed
 S1-8 3000/4000 host computer (On = AT BUS Off = XT BUS).

In the 1000 series computers, two hard cards are not supported.

In the 3000/4000 series computers only, when a second hard card is to be installed, jumper the second controller card according to the text above with the following exceptions:

W4 1-2 On I/O port 324
 W8 1-2 On BIOS address CA000Hex

* The W6 jumper should be set 1-2. Some of the hard card controller boards will not have W6 jumper staking pins on the board. On these boards W6 was not necessary. **DO NOT** add a jumper to these boards.

** NOTE: The settings for S1-1 and S1-2 are as follows (CLOSED refers to the jumper installed and OPEN refers to the jumper removed):

S1-1	S1-2	HEADS	CYLINDERS
CLOSED	CLOSED	4	612
OPEN	CLOSED	4	306
CLOSED	OPEN	2	615
OPEN	OPEN	4	615

The owner's manual shows these two jumpers installed. A later addendum states that they are no longer necessary and should be removed.

20 MEG Hard Card 25-1032A (figure 177):

The 25-1032A hard card has a new bubble. It is a Western Digital WD362 and has 615 cylinders and 4 heads. The correct BIOS ROM is 62-000096-033 or 62-000096-063.

The terminator is an 8 pin sip 220/330 ohms right behind the 34 pin control cable connector on the drive logic board. Pin 1 is toward the outside. Drive select jumpers on the drive logic board are behind the 20 pin data cable. The one closest to the center is W1.

The controller card is a WD1002A-WX1 type from Western Digital. It comes jumpered for a Tandy 1000/A/SX/TX. Jumpering of this board needs to be checked and jumpered according to the computer it is to be installed into.

W3 jumped Enable 64k BIOS ROM
 W4 2-3 I/O port 320
 W5 not used Trace between 1 and 2 is installed

(continued on next page)

TANDY COMPUTER PRODUCTS

W6 1-2* RWC Disable
W7 2-3 IRQ 2, S1-7 must be on
W8 2-3 BIOS address C8000Hex.

S1-1** Jumper installed
S1-2** Jumper installed
S1-7 IRQ 2, W7 must be jumped 2-3

For a 3000 series or 4000 series computer the correct setting is given below.

For a 1200 or 1000SL/TL series the jumpers are the same except that S1-8 should be open (not jumped).

W3 jumped Enable 64k BIOS ROM
W4 2-3 I/O port 320
W5 not used Trace between 1 and 2 is installed
W6 1-2* RWC Disable
W7 1-2 IRQ 5, S1-7 must be off
W8 2-3 BIOS address C8000Hex.

S1-1** Jumper installed
S1-2** Jumper installed
S1-8 3000/4000 host computer (On = AT BUS Off = XT BUS).

In the 1000 series computers, two hard cards are not supported.

In the 3000/4000 series computers only, when a second hard card is to be installed, jumper the second controller card according to the text above with the following exceptions:

W4 1-2 On I/O port 324
W8 1-2 On BIOS address CA000Hex

* The W6 jumper should be set 1-2. Some of the hard card controller boards will not have W6 jumper staking pins on the board. On these boards W6 was not necessary. **DO NOT** add a jumper to these boards.

** NOTE: The settings for S1-1 and S1-2 are as follows (CLOSED refers to the jumper installed and OPEN refers to the jumper removed):

S1-1	S1-2	HEADS	CYLINDERS
CLOSED	CLOSED	4	612
OPEN	CLOSED	4	306
CLOSED	OPEN	2	615
OPEN	OPEN	4	615

The owner's manual shows these two jumpers installed. A later addendum states that they are no longer necessary and should be removed.

TANDY COMPUTER PRODUCTS

20 MEG Hard Card 25-1032B (figure 177)

The 25-1032B hard card is the same as the 25-1032A. It has a Western Digital WD362 bubble and has 615 cylinders and 4 heads. The correct BIOS ROM is 62-000274-030.

The terminator is an 8 pin sip 220/330 ohms right behind the 34 pin control cable connector on the drive logic board. Pin 1 is toward the outside. Drive select jumpers on the drive logic board are behind the 20 pin data cable. The one closest to the center is W1.

The controller card is a WD1002A-WX1 type from Western Digital. It comes jumpered for a Tandy 1000/A/SX/TX. Jumpering of this board needs to be checked and jumpered according to the computer it is to be installed into.

W3 jumped	Enable 64k BIOS ROM
W4 2-3	I/O port 320
W5 not used	Trace between 1 and 2 is installed
W6 1-2*	RWC Disable
W7 2-3	IRQ 2, S1-7 must be on
W8 2-3	BIOS address C8000Hex.
S1-1**	Jumper installed
S1-2**	Jumper installed
S1-7	IRQ 2, W7 must be jumped 2-3

For a 3000 series or 4000 series computer the correct setting is given below.

For a 1200 or 1000SL/TL series the jumpers are the same except that S1-8 should be open (not jumped).

W3 jumped	Enable 64k BIOS ROM
W4 2-3	I/O port 320
W5 not used	Trace between 1 and 2 is installed
W6 1-2*	RWC Disable
W7 1-2	IRQ 5, S1-7 must be off
W8 2-3	BIOS address C8000Hex.
S1-1**	Jumper installed
S1-2**	Jumper installed
S1-8	3000/4000 host computer (On = AT BUS Off = XT BUS).

In the 1000 series computers, two hard cards are not supported.

(continued on next page)

TANDY COMPUTER PRODUCTS

In the 3000/4000 series computers only, when a second hard card is to be installed, jumper the second controller card according to the text above with the following exceptions:

W4 1-2 On I/O port 324
W8 1-2 On BIOS address CA000Hex

* The W6 jumper should be set 1-2. Some of the hard card controller boards will not have W6 jumper staking pins on the board. On these boards W6 was not necessary. **DO NOT** add a jumper to these boards.

** NOTE: The settings for S1-1 and S1-2 are as follows (CLOSED refers to the jumper installed and OPEN refers to the jumper removed):

S1-1	S1-2	HEADS	CYLINDERS
CLOSED	CLOSED	4	612
OPEN	CLOSED	4	306
CLOSED	OPEN	2	615
OPEN	OPEN	4	615

The owner's manual shows these two jumpers installed. A later addendum states that they are no longer necessary and should be removed.

20 MEG Hard Card 25-1032C,D,E and F (figure 178):

The 25-1032C, D and E's utilize a type of interface called IDE or Integrated Drive Electronics. The controller has been moved to a "smart" drive logic board which has a 40 pin connector to a "dumb" interface board (also known as a "paddle" board, see figure 178). The bubble is a WD93028 and looks like the TM362 bubble with a 46 pin header connector, as in figure 233. The header on the bubble has 46 pins, but the six pins closest to the DC power connector are option jumpers. The two pins closest to the DC connector are jumped, the other four are open; these are set by the factory and **MUST NOT** be changed (see figure 233). The 20 Megabyte drive has 782 cylinders, 2 heads, and 26 sectors per track. The "paddle" board only has a few buffer chips and a BIOS ROM.

Reference Technical Bulletins HD:50 and HD:52 for more information on using these hard cards in various computers.

Jumpers are as follows:

W1 1-2 BIOS address CA000 hex
W1 2-3 BIOS address C8000 hex (default)

W2 1-2 I/O port 320 hex (default)
W2 2-3 I/O port 324 hex

(continued on next page)

TANDY COMPUTER PRODUCTS

W3 1-2 IRQ5 (default)*
W3 2-3 IRQ2

*Note: This is the default setting for this jumper. It may need to be changed according to various software programs and hardware configurations, depending on the system you are dealing with.

For a 1000/A/SX/TX computer:
W1 2-3
W2 1-2
W3 2-3

For a 1200/3000 series/4000 series/1000SL/TL series computer
W1 2-3
W2 1-2
W3 1-2

More than one hard card is not permitted in the 1000 series. If you have a 3000/4000 series computer and want to use two 1032C hard cards, the second hard card is jumpered as follows:

W1 1-2
W2 2-3
W3 1-2

40 MEG Hard Card 25-4059 and 25-4059A (For 25-4059B see page Hard Drive.59)
Figure 179 = Hard Card Controller
Figure 180 = Seagate ST-157 40 MEG Hard Drive Logic Board
Figure 264 = Western Digital WD344 40 MEG Hard Drive Logic Board

This is an RLL controlled hard drive. It has a faster transfer rate (7.5 Megabits/sec) and a faster access time (40 ms avg.) than previous hard cards. If the drive is partitioned as two 20 Megabytes, the average access time is about 28 milliseconds.

This hard card should be formatted using the "autoinstall" program which already comes on the hard card. Do not use any other low level formatting program such as HSECT. If you do, this will not work and it will erase the autoinstallation program that comes with the drive. An alternate formatting procedure using DEBUG will have to be used. Refer to the owner's manual for further instructions.

The 4059 drive is a Seagate ST-157R. The drive select jumper is the two pins of J7 closest to the terminator pak. The terminator is a 10 pin 220/330 ohm SIP. Pin 1 is the square pad closest to the power connector. Refer to figure 180.

(continued on next page)

TANDY COMPUTER PRODUCTS

The 25-4059A drive is a Western Digital WD-344R. The drive \emptyset select jumper is the two pins closest to the terminator pak. The terminator is a 8 pin 220/330 ohm SIP. Pin 1 is the square pad closest to the power connector. Refer to figure 264 which shows the component side of the logic board which is facing towards the bubble.

The controller card is a WD1002-27X type from Western Digital. It looks a lot like the 20 Meg hard card controller board, but it is RLL instead of MFM. It is not a legitimate substitute for the 25-1032 drive controller. The jumpers are in the same places but do different things. It is shipped set up for a Tandy 3000.

Tandy 3000/4000 series - Note: These jumpers will be the same for the 1200 or 1000SL/TL series except for S1-8 which should be off (not jumped).

W3 jumped	Enable 64k BIOS ROM
W4 2-3	I/O port 320
W5 not used	Trace between 1 and 2 is installed
W6 1-2*	RWC Disable
W7 1-2	IRQ 5, S1-7 must be off
W8 2-3	BIOS address C8000Hex.
W9 off	No translate mode
S1-6	Jumped ALWAYS!!!
S1-8	AT class computer

All other jumpers on S1 are open.

Tandy 1000/A/SX/TX

W3 jumped	Enable 64k BIOS ROM
W4 2-3	I/O port 320
W5 not used	Trace between 1 and 2 is installed
W6 1-2*	RWC Disable
W7 2-3	IRQ 2, S1-7 must be on
W8 2-3	BIOS address C8000Hex.
W9 off	No translate mode
S1-6	Jumped ALWAYS!!!
S1-7	IRQ 2, W7 must be jumped 2-3

All other jumpers on S1 are open.

150 MEG SCSI tape drive 25-4169 (figure 181):

There are three terminators which may or may not be installed depending on the location of the drive on the cable chain. Terminators should be installed in the last drive on the cable.

J4, pin pair 1	off	(standard) Terminator power not supplied by tape drive.
	on	Terminator power supplied by the tape drive.
J4, pin pair 2	off	Parity checking disabled.
	on	(standard) Parity checking enabled.

(continued on next page)

TANDY COMPUTER PRODUCTS

SW1-P Jumped - parity enabled
SW1-D Not jumped - Diagnostic Operation Disabled
SW1-S Not jumped - Not used

J12 Jumped
J14 Jumped

The rest of the jumpers are used by the factory and should not be jumped or changed.

The interface board is the same one used on the 25-4064. The switches and jumpers are the same but the ROM is new. See Hard Drive.11 for jumper information on the interface board. The ROM is a version 4.48 and must be used with the 4.48 DCS utilities! The 4.48 utilities disk comes with the drive from TEW and, of course, the ROM is installed as well. National Parts kit number is AXX-7145 catalog number 25-4064A.

This drive cannot be used in the Tandy 1000 series. It can be installed in either slot of a Tandy 3000, 3000 fast, 4000, or a 3000HL. If installed in an early 3000HL and another hard drive is in the tower, the cooling fan in Technical Bulletin 3000HL:5 is mandatory.

40 MEG Internal Tape Cartridge System 25-4069/A (figure 183):

The 40 MEG internal tape cartridge installs into a 1200/3000/4000 series computer without a separate interface board. Instead, it plugs directly into the second floppy drive cable edge connector, and uses the host's FDC circuitry. It cannot be used in computer that supplies power on the floppy drive ribbon cable. It also cannot be used in a computer that does NOT have a twist in the ribbon cable. A longer ribbon cable with keyed connectors is included with the TCS kit and must be used. Lastly, the DC power cable normally used for the second floppy plugs to the tape drive.

Mini 3.8" x 2.1" factory pre-formatted cartridges plug into the front of the TCS, sort of like an "8-track" tape. Unlike our DCS's the cartridge may be reformatted using the "tape" utility (beware! - it takes in excess of an hour to format these tapes!).

There are no jumpers to set, but there is a terminator included with the TCS. It should be installed at RP1 **ONLY** if adding the TCS to a dual floppy drive system. This special setup can be accomplished by the use of the CMS Tape Drive Mux Adapter (90-2405) discussed in the Upgrade Board chapter on page 47. It also requires the use of a special CK80 cable (90-2406).

In a single floppy drive system, the terminator should be removed, which disables the termination. You must tell SETUP that there is no Drive B:, as the TCS is not accessed through the DOS's drive B:.

(continued on next page)

TANDY COMPUTER PRODUCTS

To run the TCS you must have a hard drive in the system, BIOS 1.03.01 or later and DOS 3.2.2 or later. As a note, BIOS version 1.03.01 for the Tandy 4000 may give a SETUP error when booting that does not affect TCS operation. BIOS version 1.03.02 does not exhibit the error. Utility disks included with the TCS contain drivers to be installed onto drive C:, and also contain menu driven programs to access the tape drive through the utility "tape".

The difference between the 25-4069 and the 25-4069A is that the 25-4069 came with Version 1.71 utilities and the 25-4069A came with Version 2.04 utilities.

One final note: In the utilities menu there is an option for Concurrent Disk/Tape operation. This should be set to the off position **ALWAYS**. Refer to the installation manual for further details on running the TCS utilities.

60 MEG Internal Tape Cartridge System 25-4079 (figure 243):

The 60 MEG internal tape cartridge installs into a 1200/3000/4000 series computer without a separate interface board. Instead, it plugs directly into the second floppy drive cable edge connector, and uses the host's FDC circuitry. A longer ribbon cable with keyed connectors is included with the TCS kit and may be used. Lastly, the DC power cable normally used for the second floppy plugs to the tape drive.

Mini 3.8" x 2.1" factory pre-formatted cartridges plug into the front of the TCS, sort of like an "8-track" tape. Unlike our DCS's the cartridge may be reformatted using the "tape" utility (beware! - it takes in excess of an hour to format these tapes!). Catalog number for the 60 MEG tape cartridge is 26-246.

There is only one set of 3 jumpers which are located on the side of the TCS. These jumpers determine if termination is enabled or disabled. **Termination should be enabled ONLY** if adding the TCS to a dual floppy drive system. This special setup can be accomplished by the use of the CMS Tape Drive Mux Adapter (90-2405) discussed in the Upgrade Board chapter on page 47. It also requires the use of a special CK80 cable (90-2406).

In a single floppy drive system, the 3 jumpers should NOT be jumpered, which disables the termination. You must tell SETUP that there is no Drive B:, as the TCS is not accessed through the DOS's drive B:.

To run the TCS you must have a hard drive in the system, BIOS 1.03.01 or later and DOS 3.2.2 or later. As a note, BIOS version 1.03.01 for the Tandy 4000 may give a SETUP error when booting that does not affect TCS operation. BIOS version 1.03.02 does not exhibit the error. Utility disks included with the TCS contain drivers to be installed onto drive C:, and also contain menu driven programs to access the tape drive through the utility "tape".

One final note: In the utilities menu there is an option for Concurrent Disk/Tape operation. This should be set to the off position **ALWAYS**. Refer to the installation manual for further details on running the TCS utilities.

TANDY COMPUTER PRODUCTS

60 MEG Internal SCORPION TAPE DRIVE CARTRIDGE System 90-2060
(figures 184, 185 & 186)

This device has two different interface board styles -- one being a "long", or full-length card, and the other being a "short" card. The jumper settings for these boards are similar to one another, but not identical, and this goes for the software initialization procedures you will follow as well.

The jumpers on the tape drive mechanism itself (figure 184) are not to be changed. They are to be left as they are set from the factory.

Hardware Considerations:"Long" board (SC499 interface) figure 185:

Jumpers for this board in an MS-DOS environment are:

CC, Y, KK, A9, A5, IRQ3, DRQ1*, DACK1*

* NOTE: The jumper settings for the DMA channels are the recommended settings. They may have to be changed depending on the configuration of the computer you are working on. Be sure to reconfigure the installation software for any change in jumpering.

This will set this board up for operation at port address 0220H, interrupt request 3, DMA request 1 and DACK (data acknowledge) 1.

Jumpers for this board in a Xenix environment are:

CC, Y, KK, A9, A5, IRQ3, DRQ3, DACK3

This will set this board up for operation at port address 0220H, interrupt request 3, DMA request 3 and DACK (data acknowledge) 3.

"Short" board (SC499R interface) figure 186:

Jumpers for this board in an MS-DOS environment are:

KK, 45MB, Q24, ADDR CMP 3, ADDR CMP 4, ADDR CMP 6, ADDR CMP 7,
ADDR CMP 8, ADDR CMP 10, IRQ3, DRQ1*, DACK1*.

* NOTE: The jumper settings for the DMA channels are the recommended settings. They may have to be changed depending on the configuration of the computer you are working on. Be sure to reconfigure the installation software for any change in jumpering.

This will set this board up for operation at port address 0220H, interrupt request 3, DMA request 1 and DACK (data acknowledge) 1.

(continued on next page)

TANDY COMPUTER PRODUCTS

Jumpers for this board in a Xenix environment are:

KK, 45MB, Q24, ADDR CMP 3, ADDR CMP 4, ADDR CMP 6, ADDR CMP 7,
ADDR CMP 8, ADDR CMP 10, IRQ3, DRQ3, DACK3.

This will set this board up for operation at port address 0220H, interrupt request 3, and DMA request and acknowledge 3.

Additional information on Xenix software use can be found in the Xenix information manuals published and distributed by Technical Support Information Series.

AT SmartDrive Interface Adapter Board 25-4121 (figure 246):

This interface board allows the addition of an IDE AT SmartDrive to an AT class computer. There are six jumpers located on the interface board. These jumpers do not need to be changed for normal installations.

The SmartDrive Interface Board is designed for computers with a bus speed running up to 8 MHz. If the computer bus runs at a faster speed, then you must use the Reference Disk or setup program to change it to 8 MHz.

When installing a 40 Meg or 80 Meg SmartDrive in a 3000 series, 4000 or a 4000LX computer, you must use a SmartDrive interface (Catalog# 25-4121). The jumper settings for the IDE interface are as follows:

<u>Jumper</u>	<u>Function</u>	<u>Assignment (> = default)</u>
JP1	Address Select	> Removed Installed - Secondary address 170 through 177, 376 through 377 decoded (for systems having this capability).
JP2	I/O Channel Ready	> Installed - Gates I/O channel ready to the system bus. (DO NOT REMOVE)
JP3		> Removed - Normal Operation.
JP4		> Installed - Normal Operation.
JP5		> Removed - Normal Operation.
JP6	Active	> Installed - Normal operation. Enables activity LED on interface board Removed - Disables interface board activity LED

* Run the fdisk program to partition the SmartDrive.

* Run the format program to format the SmartDrive.

* NOTE: The AT style, IDE SmartDrives will not work with the ST506 Hard drives in the same machine. Both the ST506 and the IDE interfaces sit at the same ports and addresses. This conflict will not be tolerated by the system.

40 Megabyte Miniscribe 8051A 3.5 inch Smart Drive 25-4119 (figure 230):

Requires MS-DOS 3.30.00 or greater.

Use drive type 17 - 5 heads, 977 cylinders

When only "1" drive is installed.

- J4 1-2 OFF Used for SLAVE drive selection. When 2 drives are used this jumper should be OFF for the MASTER drive and ON for the SLAVE drive.
- J4 3-4 OFF Selects 2:1 or 1:1 interleaving. (OFF is 1:1)
- J4 5-6 OFF Used for MASTER select when only 1 drive is used. When 2 drives are used this jumper should be on for a MASTER drive and off for a SLAVE drive.
- J4 7-8 OFF Is NOT used and should never be installed.
- J4 9-10 OFF Disables or Enables I/O Channel Ready Signal (OFF is Disabled).

When 2 drives* are used as a master and slave.

MASTER		SLAVE	
J4 1-2	OFF	J4 1-2	ON
J4 3-4	OFF	J4 3-4	OFF
J4 5-6	ON	J4 5-6	OFF
J4 7-8	OFF	J4 7-8	OFF
J4 9-10	OFF	J4 9-10	OFF

* Some versions of this drive sold by other companies cannot be daisy chained (have more than one drive). Refer to Technical Bulletin HD:54 for a detailed description of this information.

NOTE: The AT style, IDE SmartDrives will not work with the ST506 hard drives in the same machine. Both the ST506 and the IDE interfaces sit at the same ports and addresses. This conflict will not be tolerated by the system.

80 Megabyte Miniscribe 7080A 19ms 3.5 inch Smart Drive 25-4120 (figure 231):

When only "1" Drive is installed.

- J11 OFF Factory Setting
- J13 OFF Factory Setting
- J14 SEE NOTE "A"
- J15 OFF Factory Setting
- J16 OFF Factory Setting
- J17 ON Selects 80 MB or 40 MB (ON is 80 MB)
- J18 ON Selects 4 or 7 bytes ECC used (ON is 4 bytes)
- J19 ON Drive Select
- J20 ON Drive Select

(continued on next page)

TANDY COMPUTER PRODUCTS

When 2 drives are used as a master and slave.

MASTER		SLAVE	
J11	OFF	J11	OFF
J13	OFF	J13	OFF
J14	SEE NOTE "A"	J14	SEE NOTE "A"
J15	OFF	J15	OFF
J16	OFF	J16	OFF
J17	ON	J17	ON
J18	ON	J18	ON
J19	OFF	J19	ON
J20	ON	J20	OFF

NOTE A Install J14 if DRIVE TYPE "35" is going to be used.
Remove J14 if DRIVE TYPE "28" is going to be used.

*** To install the 80 Meg Drive: (Cat# 25-4120)**

- Use MSDOS version 3.30.00 or greater.
 - The 2500XL, 4016DX, 4016SX, 4000SX, and 4020/25/33LX ROM's are configured for Drive type 28.
 - With Drive type 28, (977 cylinders, 10 heads), selected the drive has a configuration of about 81 megabytes. (Some of the newer ROM's have 981 cylinders, 10 heads listed for Drive type 28. This will not affect the operation of the drive.)
- * On the MS-DOS machines that do not have drive type 28 or 35 in BIOS, it will give you a "Hard Drive Failure" error after each power up or reboot. If the system boots from the floppy drive, the IDE drive can be accessed as normal.
- * If you have a 3000NL with a BIOS ROM version that is earlier than 1.04.02, the following applies:
- Use Drive type 28, (8 heads, 1024 cylinders). Use SETUPNL1. The IDE drive capacity is about 68 Megabytes. However, the 3000NL will give you a "Hard Drive Failure" error after each power up or reboot. If the system boots from the floppy drive, the IDE drive can be accessed as normal.
 - The recommended method is to upgrade the BIOS ROM to 1.04.02, and use SETUPNL2. Now you can select Drive type 35 (not in earlier versions of ROMS). The IDE drive capacity is about 76 Megabytes.

(continued on next page)

TANDY COMPUTER PRODUCTS

- * When using Drive type 35 (9 heads, 1023 cyl.) you **MUST** put a jumper on J14 of the IDE drive. The location of J14 is shown in figure 231. By placing the jumper at J14 you change the head count from 10 heads to 9. The cylinder count from 977 cylinders to 1023 cylinders.
- * There is an error in the 80 Meg IDE drive installation manual. The first line of the chart on page 25 is incorrect. Here is the correct chart.
> = default setting:

<u>J20</u>	<u>J19</u>	<u>Description</u>
ON	ON	> Normal Mode, only drive on system.
ON	OFF	Master drive on two drive system.
OFF	ON	Slave drive on two drive system.
OFF	OFF	Not used.

<u>J18</u>	<u>Description</u>	
ON	> 4 bytes ECC used.	NOTE: J11, J13, J15, and J16 are factory settings and should be left alone.
OFF	7 bytes ECC used.	

<u>J17</u>	<u>Description</u>
ON	> Model 7080A 80 MB.
OFF	Model 7040A 40 MB.

<u>J14</u>	<u>Description</u>
ON	Drive Type 35.
OFF	> Drive Type 28.

- * The Smartdrive jumper pins J11, J13-J20, use micro-jumpers. Normal size jumpers will **NOT** work, though they appear to fit properly. If you do not have any micro-jumpers, you can wire wrap the correct jumper pins. You can get micro-jumpers from:

National Parts, Catalog# 25-1061, Part# JD-0007.

- * NOTE: The AT style, IDE Smartdrives will not work with the ST506 Hard drives in the same machine. Both the ST506 and the IDE interfaces sit at the same ports and addresses. This conflict will not be tolerated by the system.

TANDY COMPUTER PRODUCTS

150 Megabyte Internal ESDI Hard Drive 25-4151 (figure 232):

	PRIMARY	SECONDARY	
J4	OFF	OFF	
J9	OFF	OFF	
J10	OFF	OFF	
J11	OFF	OFF	
J12	OFF	OFF	
J13	OFF	OFF	
J14	ON	ON	
J15	Jumper Set #1	ON	OFF Drive Select 1
J15	Jumper Set #2	OFF	ON Drive Select 2
J15	Jumper Set #3	OFF	OFF Drive Select 3
J19	OFF	OFF	
J20	ON	ON	
J21	ON	ON	
J23	OFF	OFF	
J24	ON	ON	
J25	OFF	OFF	
J27	ON	ON	
J29	ON	ON	
J30	ON	ON	
J510	ON	ON	

<u>Termination</u>	<u>Primary</u>	<u>Secondary</u>
1 Drive	Installed	
2 Drives	Removed	Installed

20 Megabyte SmartDrive 25-1045 (figure 233):

The 20 Meg SmartDrive is a WD93028 bubble. It uses an IDE interface and has 782 cylinders and 2 heads.

- J8 1-2 *ON RLL
OFF MFM Translate
- J8 3-4 Reserved
- J8 5-6 ON Enables short-term burn-in loop tests
*OFF Disables short-term burn-in loop tests
- J8 3-5 Some drives come jumpered like this from the factory. This setting in the on position will disable retries. It should not be jumpered.

* = Default Settings

TANDY COMPUTER PRODUCTS**40 Megabyte SmartDrive 25-1046 (figure 233):**

The 40 Meg SmartDrive is a WD93044 bubble. It uses an IDE interface and has 782 cylinders and 4 heads.

J8 1-2 *ON RLL
OFF MFM Translate

J8 3-4 Reserved

J8 5-6 ON Enables short-term burn-in loop tests
*OFF Disables short-term burn-in loop tests

J8 3-5 Some drives come jumpered like this from the factory. This setting in the on position will disable retries. It should not be jumpered.

* = Default Settings

40 MEG AT IDE Hard Drive, 25-4123 (figure 242):

The 40 MEG AT IDE hard drive utilizes a new type of interface, called IDE or Integrated Drive Electronics. This particular drive has an AT interface, which means that it cannot be used on the 1000 series computers. The majority of the controller has been moved to a "smart" drive logic board which has a 40 pin connector to a "dumb" interface. The bubble is a Conner CP3044 and has a 42.8 megabyte formatted capacity in 977 cylinders, 5 heads, and 17 sectors per track. It is a 1" high hard drive which installs into a standard 3 1/2" drive slot.

There are three connectors on this drive, the outside two are the power connectors (J3, which is the standard power connector, and J5 a 3-pin power connector) and the inner 40-pin header is the IDE port (J2). The configuration jumpers are located just behind the 3-pin power connector on the bottom of the drive (see figure 242).

ACT Provides signal to drive external LED and slave drive status
DSP/CD Determines # of drives and primary/secondary status
HSP Reserved for future use

Single IDE Drive System	Dual IDE Drive System Primary Drive	Dual IDE Drive System Secondary Drive
ACT Not jumped	ACT Not Jumped	ACT Jumped
DSP Not jumped	DSP Jumped	DSP Not jumped
C/D Jumped	C/D Jumped	C/D Not jumped
HSP Not jumped	HSP Not jumped	HSP Not jumped

Western Digital WD1007V-MC1 ESDI Controller for Tandy 5000MC 900-2450 (figure 259):

There are no jumpers for this board. The setup is autoconfigured using the 5000MC reference disk.

Western Digital WD1007-SE1 AT ESDI Controller 90-2370 (figure 258):

This is a WD1007V-SE1 Winchester Hard Disk Controller interface. It is capable of controlling two ESDI compatible hard disk drives (such as the 25-4151 150 Meg).

The ROM format routine for this drive sets up your BIOS hard drive table for you, so it is not necessary to select a drive in SETUP. To run the ROM routine, run DEBUG and then type at the "-" prompt: G=CC00:5 (or G=C800:5 if W8 1-2 is ON). At this juncture it is recommended to run (in the following order) Low Level Format, Mark Defect List Auto, Verify Drive, Surface Analysis, Set Drive Type and Exit. Jumpers are as follows:

Pins	Default	Description (in default state)
W1:		
1-2	OFF	Enables look-ahead cacheing
3-4	OFF	Four byte ECC mode
5-6	OFF	Enables disk translation
7-8	OFF	Reserved
9-10	OFF	Sectors per track determined by drive jumpers
11-12	OFF	Alternate sector disable
W7	1-2	IRQ 14 (IRQ 15 if 2-3 is jumpered)
W8	2-3	BIOS address is CC00:00 (1-2 jumped = C800:00)
W3	OFF	BIOS ROM enabled
W5	OFF	Single speed floppy drive
W6	OFF	Primary floppy address (3F2-3F7 Hex)
W12	OFF	Primary hard disk address (1F0-1F7)

Western Digital WD1003V-MM1 16-bit Hard Drive Controller 25-4058 (figure 222):

All jumpers are off for factory defaults.

- W1: 1-2 Off Winchester(s) in latched mode.
On Winchester(s) in non-latched mode.
- 3-4 Off Four byte ECC.
On Reserved.
- 5-6 Off Cacheing enabled.
On Cacheing disabled.
- 7-8 Off Format incompatible with WD1003-WAH(WD1003-WA2).
On Format compatible with WD1003-WAH(WD1003-WA2).

(continued on next page)

W3: 1-2 Off Primary Winchester I/O address.
On Secondary Winchester I/O address.

W4: NOT USED. Floppy version only.

W5: NOT USED. Floppy version only.

W6: 1-2 OFF Bracket ground option, NOT USED.
ON Connects bracket to board ground.

Hitachi CD ROM Player and Interface 25-1081 (figure 244):

Jumpers located on the interface card:

I/O address select

Connected Switch	Address
S0	200-20F
S1	220-22F
S2	240-24f
S3	260-26F
S4	300-30F (Default)
S5	320-32F
S6	340-34F
S7	360-36F

DIP switches on the CD ROM Player

Notes:

- All other switches not mentioned should be off.
- S6 is for latched DREQ mode (set to ON) or edged DREQ mode (DEFAULT mode which is set to OFF)
- Only one of switches S1 through S4 can be on at one time on one drive

S1 on and S5 on = DS0	S1 on and S5 off = DS4
S2 on and S5 on = DS1	S2 on and S5 off = DS5
S3 on and S5 on = DS2	S3 on and S5 off = DS6
S4 on and S5 on = DS3	S4 on and S5 off = DS7

TANDY COMPUTER PRODUCTS

Mitsumi CDR-1000 Internal CD-ROM Drive 25-1077 (figure 312):**Jumpers and Settings:**

The port address, DMA channel, and IRQ channel, must be set on the interface adapter before installation and operation.

The port address is set using an 8 position dip switch (SW1). Positions 7 and 8 are not used and are always set to the OFF position. There are only "5" port addresses used. The default is 300 - 302 hex.

Addresses	SWITCHES							
	1	2	3	4	5	6	7	8
300 - 302 hex	ON	ON	ON	ON	ON	ON	OFF	OFF
310 - 312 hex	ON	ON	OFF	ON	ON	ON	OFF	OFF
340 - 342 hex	ON	ON	ON	ON	OFF	ON	OFF	OFF
360 - 362 hex	ON	ON	ON	OFF	OFF	ON	OFF	OFF
390 - 392 hex	ON	ON	OFF	ON	ON	OFF	OFF	OFF

The DMA channel is set using JP1. Only DMA channel 3 or 1 can be used. The default is DMA 3.

DMA "3"	DMA "1"
1 o o 2	1 o-o 2
3 o o 4	3 o-o 4
5 o-o 6	5 o o 6
7 o-o 8	7 o o 8
JP1	JP1

The IRQ channel is set using JP2. Only IRQ 2, 3, or 5 can be used. The default is IRQ 3.

	1 o o 2	IRQ2
JP2	3 o-o 4	IRQ3
	5 o o 8	IRQ5

Hitachi External CDR-1503S CD-ROM Drive 90-2156 (figure 314):

The interface board is a CD-IFI4-A.
S0-S7 jumper pin pairs set the I/O address.

PINS	ADDRESS (HEX)
o o S7	360-36F
o o S6	340-34F
o o S5	320-32F
o-o S4	(Factory Setting, 300-30F)
o o S3	260-26F
o o S2	240-24F
o o S1	220-22F
o o S0	200-20F

(continued on next page)

On the rear of the drive is a rotary switch.

Position 0, Sets drive No. to Drive 0.
 Position 1, Sets drive No. to Drive 1.
 Position 2, Sets drive No. to Drive 2.
 Position 3, Sets drive No. to Drive 3.
 Position NDS, Sets Single Operation Mode (No other drive attached to cable).

Hitachi External CD-ROM Drive CDR-1700S 903-2376 (figure 313):

The interface board is a CD-IFI4-A.
 S0-S7 jumper pin pairs set the I/O address.

PINS	ADDRESS (HEX)
o o S7	360-36F
o o S6	340-34F
o o S5	320-32F
o-o S4	(Factory Setting, 300-30F)
o o S3	260-26F
o o S2	240-24F
o o S1	220-22F
o o S0	200-20F

On the rear of the Drive exists a dip switch.
 Switches 1 to 6 set the drive ID.

DRIVE ID=0, SW 1 and 5 on (up)
 SW 2,3,4,6 off (down)

SW1, Sets drive No. to Drive 0/4
 SW2, Sets drive No. to Drive 1/5
 SW3, Sets drive No. to Drive 2/6
 SW4, Sets drive No. to Drive 3/7
 SW5, Drive No. selector (If on, you are selecting Drives 0-3)
 (If off, you are selecting Drives 4-7)
 SW6, Reserved (Not used)

TANDY COMPUTER PRODUCTS

40 Meg IDE Hard Card 25-4059B (figure 178 and 233):

The 25-4059B utilizes an IDE or Integrated Drive Electronics interface. The controller has been moved to a "smart" drive logic board which has a 40 pin connector to a "dumb" interface board (also known as a "paddle" board, see figure 178). The bubble is a WD93044 and looks like the TM362 bubble with a 46 pin header connector, as in figure 233. The header on the bubble has 46 pins, but the six pins closest to the DC power connector are option jumpers. The two pins closest to the DC connector are jumped, the other four are open; these are set by the factory and MUST NOT be changed (see figure 233). The 40 Megabyte drive has 782 cylinders, 4 heads, and 26 sectors per track. The "paddle" board only has a few buffer chips and a BIOS ROM.

Jumpers for the "paddle" board (figure 178) are as follows:

W1 1-2 BIOS address CA000 hex
W1 2-3 BIOS address C8000 hex (default)

W2 1-2 I/O port 320 hex (default)
W2 2-3 I/O port 324 hex

W3 1-2 IRQ5 (default)*
W3 2-3 IRQ2

*Note: This is the default setting for this jumper. It may need to be changed according to various software programs and hardware configurations, depending on the system you are dealing with.

For a 1000/A/SX/TX computer:

W1 2-3
W2 1-2
W3 2-3

For a 1200/3000 series/4000 series/1000SL/TL series computers

W1 2-3
W2 1-2
W3 1-2

More than one hard card is not permitted in the 1000 series. If you have a 3000/4000 series computer and want to use two 4059B hard cards, the second hard card is jumpered as follows:

W1 1-2
W2 2-3
W3 1-2

(continued on next page)

TANDY COMPUTER PRODUCTS

Jumpers for the 25-4059B 40 Meg IDE Hard Drive (figure 233) are as follows:

The 40 Meg IDE hard drive uses a WD93044 bubble. It also uses an IDE interface and has 782 cylinders and 4 heads.

J8 1-2	*ON RLL OFF MFM Translate
J8 3-4	Reserved
J8 5-6	ON Enables short-term burn-in loop tests *OFF Disables short-term burn-in loop tests
J8 3-5	Some drives come jumpered like this from the factory. This setting in the on position will disable retries. It should not be jumpered.

* = Default Settings

Seagate ST-325X 20 Meg IDE Hard Drive 25-1047 (figure 292):

The ST-325X utilizes the IDE-XT interface. The drive logically formats as 615 tracks, 4 heads, 17 sectors/track, and 512 bytes/sector for a total of 21.4 Megabytes. Technical Bulletin HD:48 is especially applicable with this drive. In addition the drive should not be tilted more than 5 degrees from horizontal or from vertical.

The jumpers are factory set and will not need to be changed for any standard configuration. The factory settings are:

J5 1-2	Reset Active High
J5 3-4	Reset Active Low (*Factory Default)
J5 5-6	Life Test

Seagate ST-351A/X 40 Meg IDE Hard Drive 25-1048 (figure 293):

The Seagate ST-351A/X IDE hard drive is jumper selectable for use in either a PC/XT compatible computer (such as a Tandy 1000RL) or a PC/AT compatible computer (such as a Tandy 2500XL or Tandy 4020SX). It has 5 heads, 980 cylinders, and 17 sectors per track. Figure 293 is a view of the hard drive, showing the location and numbering of the jumper pin pairs (shown jumpered for a single IDE hard drive in a PC/XT compatible computer).

(continued on next page)

TANDY COMPUTER PRODUCTS

Jumper pin pair 1 is reserved for factory use. Default for this jumper is not installed.

Jumper pin pairs 2 and 3 define master or slave status. A jumper installed on pin pair 2 indicates that the hard drive is a master hard drive in a PC/AT compatible computer. A jumper not installed on pin pair 2 indicates that the hard drive is a slave hard drive in a PC/AT compatible computer.

A jumper installed on pin pair 3 of the MASTER HARD DRIVE ONLY, indicates that a slave drive is present in a PC/AT compatible computer. On the slave hard drive, jumper pin pair 3 must not be installed.

In a PC/XT compatible computer, two IDE hard drives are not supported. Jumper pin pair 2 must be installed on a single hard drive. Jumper pin pair 3 must not be installed.

Jumper pin pair 4 is reserved for factory use. Default for this jumper is not installed.

Jumper pin pair 5 and 6 define the type of computer the hard drive is installed in. In a PC/AT compatible computer, jumper pin pair 5 must not be installed and jumper pin pair 6 must be installed. In a PC/XT compatible computer jumper pin pair 5 must be installed and jumper pin pair 6 must not be installed.

Jumper pin pair 7 enables or disables a remote hard drive activity LED. If a jumper is installed, a remote hard drive activity LED is active (only if supported by the particular computer). If a jumper is not installed, a remote hard drive activity LED is not active. Default for this jumper is not installed.

Jumper pin pair 8 is reserved for factory use. Default for this jumper is not installed.

Jumper pin pair 9 is reserved for factory use. Default for this jumper is installed.

The following table summarizes the jumper settings for various configurations of master and slave hard drives.

Pin Pair	PC/XT Single	PC/AT Master Without Slave	PC/AT Master With Slave	PC/AT Slave
1	Not Installed	Not Installed	Not Installed	Not Installed
2	Installed	Installed	Installed	Not Installed
3	Not Installed	Not Installed	Installed	Not Installed
4	Not Installed	Not Installed	Not Installed	Not Installed
5	Installed	Not Installed	Not Installed	Not Installed
6	Not Installed	Installed	Installed	Installed
7	Not Installed	Not Installed	Not Installed	Not Installed
8	Not Installed	Not Installed	Not Installed	Not Installed
9	Installed	Installed	Installed	Installed

TANDY COMPUTER PRODUCTS

52 Megabyte Quantum LPS52 3.5 inch IDE Hard Drive 25-4124 (figure 294):

Requires MSDOS 3.30.00 or greater.

Use drive type "Non-standard" and enter the following specifications:

Cylinders	751
Heads	8
Landing Zone	750
Sectors	17
Precomp	0

Other combinations of heads and cylinders can be used as long as the total drive size is less than 52 MEG, according to the formula given below based on the following notes:

1. * = multiply
2. # of heads must be 16 or less
3. # of cylinders must be 1024 or less

(512 bytes/sector) * (# of sectors/cylinder) * (# of heads) * (# of cylinders)

For Novell use, you MUST use drive type 12 (49.6 Meg.). On machines that do not have the "Non-standard" option, use the drive type that comes closest to the 52 Meg capacity without exceeding 16 heads and 1024 cylinders and 52 Meg.

NEVER LOW LEVEL FORMAT (HSECT) THIS DRIVE!

The following are the jumper settings when only 1 drive is installed.

DS	installed	Indicates that this drive is the "master" drive. When removed, this jumper indicates that this device is a slave drive.
DM	removed	Indicates that no ProDrive P40AT or P80AT is installed on the bus. When installed, this jumper indicates that a ProDrive is on the bus.
SP	removed	Disables self seek mode. When installed, indicates that the self seek mode is enabled.

The following are the jumper settings when two drives are installed. One will be designated "master" and the other will be the "slave".

	<u>Master</u>	<u>Slave</u>
DS	installed	removed
DM	removed	removed
SP	installed	removed

TANDY COMPUTER PRODUCTS

105 Megabyte Quantum LPS105 3.5 inch IDE Hard Drive 25-4130 (figure 294):

Requires MSDOS 3.30.00 or greater.

On those machines that have the option, use drive type "Non-standard" and enter the following specifications:

Cylinders	755
Heads	16
Landing Zone	754
Sectors	17
Precomp	0

Other combinations of heads and cylinders can be used as long as the total drive size is less than 105 MEG, according to the formula given below based on the following notes:

1. * = multiply
2. # of heads must be 16 or less
3. # of cylinders must be 1024 or less

$(512 \text{ bytes/sector}) * (\# \text{ of sectors/cylinder}) * (\# \text{ of heads}) * (\# \text{ of cylinders})$

For Novell use, you MUST use drive type 36 (84.9 Meg.). On machines that do not have the "Non-standard" option, use the drive type that comes closest to the 105 Meg capacity without exceeding 16 heads and 1024 cylinders or 105 Meg.

NEVER LOW LEVEL FORMAT (HSECT) THIS DRIVE!

The following are the jumper settings when only 1 drive is installed.

DS	installed	Indicates that this drive is the "master" drive. When removed, this jumper indicates that this device is a slave drive.
DM	removed	Indicates that no ProDrive P40AT or P80AT is installed on the bus. When installed, this jumper indicates that a ProDrive is on the bus.
SP	removed	Disables self seek mode. When installed, indicates that the self seek mode is enabled.

The following are the jumper settings when two drives are installed. One will be designated "master" and the other will be the "slave".

	<u>Master</u>	<u>Slave</u>
DS	installed	removed
DM	removed	removed
SP	installed	removed

TANDY COMPUTER PRODUCTS

202 MEG SCSI Hard Drive 25-4164 (figure 295):

This is a 3.5 inch Seagate ST-1239N hard drive. Jumpering is:

J5 Jumper Pins

6 4 2

5 3 1

* OFF OFF OFF	SCSI ID0
OFF OFF ON	SCSI ID1
OFF ON OFF	SCSI ID2
OFF ON ON	SCSI ID3
ON OFF OFF	SCSI ID4
ON OFF ON	SCSI ID5
ON ON OFF	SCSI ID6
ON ON ON	SCSI ID7

Jumper Pins 7,8

*ON Enables Parity
OFF Disables Parity

Jumper Pins 9,10

*OFF Drive motor spins up when power is applied
ON Drive motor spins up on the first access to the drive

Jumper Pins 11,12

*OFF Spindle motor sync provided internally
ON Motor uses external spindle sync source

J6 Terminator power source

Jumper A,B

*Terminator power supplied by power connector

Jumper A,C

Terminator power supplied by SCSI interface

Jumper A,C and B,D

Terminator power supplied by power connector and provided to SCSI bus.

* denotes default settings

440 MEG SCSI Hard Drive 25-4167 (figure 296):

This is a 5.25 inch half height Seagate ST-2502N

The jumper block is located adjacent to the SCSI interface connector. Pin 1 is the lower pin closest to the SCSI interface connector. Pin 2 is directly above it.

Jumper pins 1,2

*ON Terminator power from power connector

Jumper pins 3,4

ON Terminator power from SCSI interface cable through a diode-fuse network

Jumper pins 2,4

ON Terminator power from SCSI interface cable through a fuse

(continued on next page)

TANDY COMPUTER PRODUCTS

Jumper Pair	5*	4*	3*		* Jumper pair 5 = jumper pins 9 and 10
					Jumper pair 4 = jumper pins 7 and 8
					Jumper pair 3 = jumper pins 5 and 6
Jumper	/ 9	7	5		
Pins	\ 10	8	6		
	OFF	OFF	OFF	SCSI ID0	
	OFF	OFF	ON	SCSI ID1	
	OFF	ON	OFF	SCSI ID2	
	OFF	ON	ON	SCSI ID3	
	ON	OFF	OFF	SCSI ID4	
	ON	OFF	ON	SCSI ID5	
	ON	ON	OFF	SCSI ID6	
	ON	ON	ON	SCSI ID7	

Jumper pair = Jumper pins

6	11,12	ON	Drive motor spins up on the first access to the drive
7	13,14	*OFF	Drive motor spins up when power is applied
		ON	Parity checking is enabled
		*OFF	Parity checking is disabled
8	15,16	*OFF	Reserved for factory use
9	17,18	*OFF	Reserved for factory use
10	19,20	*OFF	Reserved for factory use

160 MB SCSI Tape Cassette System 25-4166/A (figure 297):

The 160 MB SCSI tape cassette system is a true half-height tape drive. The 25-4166 (non "A" version) connects to a 25-4161B SCSI interface board (it will not work with the 25-4161/A versions of the SCSI interface board). The 25-4166A will work with all versions of the SCSI interface board.

This drive has four sets of configuration jumpers located on the bottom of the drive near the back (see figure 297). The jumpers labeled S0, S1, and S2 represent the SCSI ID number and S3 represents parity enable.

	SCSI ID	S2	S1	S0
	0	on	on	on
	1	on	on	off
Factory default:	*2	on	off	on
	3	on	off	off
	4	off	on	on
	5	off	on	off
	6	off	off	on
Reserved for SCSI -> interface board	**7	off	off	off

S3 is the enable parity option. When jumpered (factory default), parity is enabled.

TANDY COMPUTER PRODUCTS

Conner 2 1/2" CP-2024 20 Meg IDE Hard Drive 25-3506/3551 (figure 299):

The hard disk drive is a 2-1/2" 20MB Conner CP-2024. It is interfaced to the main logic board via a removable flat flexible cable.

<u>Drives in System</u>	<u>E1</u>	<u>E2</u>
* Single Drive System	Not Installed	Installed
Master of Two Drive System	Installed	Installed
Slave of Two Drive System	Not Installed	Not Installed

* = Indicates Factory Setting

Conner CP-2064 60 Meg IDE Hard Drive 25-3552/3571 (figure 283):

The 3810 contains a 60MB 2.8" Conner CP-2064 hard disk drive. The 3810 hard drive is preinitialized at the factory with MS-DOS and DeskMate.

The jumper settings are:

<u>Drives in System</u>	<u>E1</u>	<u>E2</u>
* Master Drive	Installed	Not Used
Slave Drive	Not Installed	Not Used

* = Indicates Factory Setting

```
*****  
*                                     *  
*                                     *  
*           U P G R A D E   B O A R D S           *  
*                                     *  
*                                     *  
*****
```

TANDY COMPUTER PRODUCTS

Arcnet board 26-6501 (figure 28):

- E2-E3 Sets the port address to x0
- E4-E5 Sets the port address to Bx
The above two jumpers set the board address to B0-B7
- E7-E8 Used when Z21 is installed
- E8-E9 Used when Z21 is not installed

Visicalc 64k memory board 26-4105 (figure 12):

- 1-2 Pulls up an input to U27 that was floating, install if missing
- 5-6 Pulls up an input to U9 that was floating, install if missing
- 25-28 Enables the first 32k on page 2 of the memory map
- 7-11 Selects the first 16k of the page set by above (page 1)
- 8-12 Selects the second 16k of the page set by above (page 1)
- 9-13 Selects the first 16k of the page + 1 set by above (page 1)
- 10-14 Selects the second 16k of the page + 1 set by above (page 1)

144k RAM board setup with 16k of RAM for ARCNET 26-6503 (figure 13):

- E24-E25 Required for proper function
- E28-E29 Not used with 16k RAMs (NOT required)
- E8-E9 Maps the RAM on page 15 of the memory map

144k RAM board setup with 64k of RAM for Visicalc 26-6503 (figure 14):

- E24-E25 Enables PAL output only in the upper 32k of the 280 memory map
- E28-E29 Addresses the RAM on 2 pages of the memory map
- E2-E11 Maps the RAM on pages 2 & 3 of the memory map

Graphics Board 26-4104 (figure 29):

- S1 1 is off and 2,3, and 4 are on (Defines the port address as 80-8F)

This board requires the same modifications to the CPU board as the Hard Disk except the boot ROM should not be changed. Refer to Technical Bulletin II:26 for the modification procedure.

First Multi-Terminal board 26-6013 (figure 31):

- E7-E8 Disables 'Break Detect' of USART for channel 4
- E10-E11 Disables 'Break Detect' of USART for channel 5
- E13-E14 Disables 'Break Detect' of USART for channel 6

- S1 is ON S2-S8 are OFF (Defines port address as 70H-7EH)

Second Multi-Terminal board:

- E7-E8 Disables 'Break Detect' of USART for channel 4
- E10-E11 Disables 'Break Detect' of USART for channel 5
- E13-E14 Disables 'Break Detect' of USART for channel 6

- S2 is ON S1,S3-S8 are OFF (Defines port address as 60H-6EH)

68000 6 MHz CPU board (figure 16):

E3-E10 Sets the interrupt acknowledge level (level should match E19)
E16-E19 Sets the interrupt level at 5
E43-E44 Causes the refresh circuit to output a pulse every 31.5 us
E47-E48 Selects a 6 MHz clock for the 68000
Pin 11 of U34 pulled out of the socket & tied to ground

Reduced size 68000 6 MHz CPU board (figure 17):

E1-E2 Causes the refresh circuit to output a pulse every 31.5 us
E4-E7 Selects a 6 MHz clock for the 68000

68000 first memory board 26-6011 (either 128K or 256K, figure 18):

E13-E14 Connects A14 directly to the RAM
E15-E16 Connects A16 directly to the RAM
E17-E18 Connects A15 directly to the RAM
E11-E12 Supplies A17 inverted to 1/2 the RAM
Position 2 of S1 on. This maps the board at 000000 to 03FFFF

68000 second memory board 26-6011 (either 384K or 512K):

Same as the first memory board except both 2 & 3 should be in the on position on S1 to map the RAM on this board between 040000 to 07FFFF.

68000 third memory board 26-6011 (either 640K or 768K):

Same as the first memory board except both 2 & 5 should be in the on position on S1 to map the RAM on this board between 080000 to 0BFFFF.

68000 fourth memory board 26-6011 (either 896K or 1024K):

Same as the first memory board except 2, 3, and 5 should be in the on position on S1 to map the RAM on this board between 0C0000 to 0FFFFFF.

8 MHz 68000 CPU board 26-6014 (figure 66):

E1-E2 Selects 15.5 usec refresh timing
E6-E7 Sets "PCLOCK" to 8 MHz

512K/1MEG 68000 RAM board with 512K 26-6014 (figure 67):

E1-E2 Select 512K RAM size
E5-E6 Along with S1 and E1-E2 maps RAM at address 000000 to 07FFFF
E7-E8 Configures A19 to select RAS multiplexor
E12-E14 Configures for 150 ns RAM (Normal configuration)
E13-E14 Configures for 200 ns RAM
S1 position 2 should be on all others should be off

TANDY COMPUTER PRODUCTS**512K/1MEG 68000 RAM board with 1MEG 26-6014 (figure 68):**

E2-E3 Select 1MEG RAM size
 E5-E6 Along with S1 and E2-E3 maps RAM at address 000000 to 0FFFFFF
 E7-E8 Configures A19 to select RAS multiplexor
 E12-E14 Configures for 150 ns RAM (Normal configuration)
 E13-E14 Configures for 200 ns RAM
 S1 position 2 should be ON, all others should be OFF

Tandy 1000 RS-232C board 25-1006 (figure 54):

E2-E3 Selects primary UART address (3F8-3FF)
 Note: E2-E3 is equivalent to no jumper at all.
 E1-E2 would select secondary UART address (2F8-2FF)

Tandy 1000 First external RAM board 25-1004 (figure 55):

No jumpers Indicates board has 128K of RAM with DMA installed
 E1-E2 Indicates board has 256K of RAM with DMA installed

Tandy 1000 Second external RAM board 25-1009 (figure 56):

E3-E4 only Indicates board has 128K of RAM with no DMA.
 E1-E2 and E3-E4 Indicates board has 256K of RAM with no DMA.

Tandy 286 Express Board 25-1035 (figure 187):

The 286 Express Board uses a main interface board and a small adapter board called a "daughter board". The daughter board that came with the kit worked with a Tandy 1000A or 1000SX. To use this product in a Tandy 1000, a special daughter board was needed. The original part # for this special daughter board is AXX-7130, however it is no longer available. The entire assembly, main interface board and daughter board, must be exchanged as a complete unit. Note that there are two separate exchange part numbers, which include the main interface board and the appropriate daughter board needed.

Switch S1-1, S1-2 and S1-10 are used to set the clock speed for math coprocessor option

<u>S1-1</u>	<u>S1-2</u>	<u>S1-10</u>	
ON	ON	ON	Invalid setting
ON	OFF	OFF	8 MHz clock speed (80287)
OFF	ON	ON	5 MHz clock speed (80287-3)
OFF	OFF	OFF	No numeric coprocessor (standard)

SW1-3 is used for the computer model

S1-3

ON Tandy 1000SX (standard)
 OFF Tandy 1000 or Tandy 1000A

(continued on next page)

TANDY COMPUTER PRODUCTS

S1-4 through S1-7 are used for memory limits for caching

<u>S1-4</u>	<u>S1-5</u>	<u>S1-6</u>	<u>S1-7</u>	
OFF	OFF	OFF	OFF	64K
OFF	OFF	OFF	ON	128K
OFF	OFF	ON	OFF	192K
OFF	OFF	ON	ON	256K (standard)
OFF	ON	OFF	OFF	320K
OFF	ON	OFF	ON	384K
OFF	ON	ON	OFF	448K
OFF	ON	ON	ON	512K
ON	OFF	OFF	OFF	576K
ON	OFF	OFF	ON	640K

Switch S1-8 must always be OFF

Switch S1-9 sets the IO address

S1-9

ON for I/O address 03E0h

OFF for I/O address 0100h (standard)

The jumper on the board must always be on the top two pins.

Tandy 2000 Hard Drive controller board 26-5127 (figure 60):

E2-E3 Connects read data from drive to data in of WD1100 chip

Tandy 2000 Monochrome graphics board 26-5140 (figure 61):

The following are trace jumpers on the board. The combination of these traces set the board configuration port to C0.

E0, E1, E2, E3, E4, and E5

Tandy 2000 Color graphics board 26-5140 (figure 62):

The following are trace jumpers on the board. The combination of these traces set the board configuration port to C2. E0, E2, E3, E4, and E5

Tandy 2000 First external Ram board 26-5161 (figure 63):

B2-S Selects board address range from 40000 to 7FFFF (384K or 512K)

Tandy 2000 Second external RAM board 26-5161 (figure 64):

B3-S Selects board address range from 80000 to BFFFF (640K or 768K)

E-F Enables BUSD2* and BUSD3* for access to second RAM board

TANDY COMPUTER PRODUCTS

Tandy 2000 Digi-Mouse/Clock board 26-5144 (figure 65):

For the 8741 processor chip (U6):

E1-E2 Selects 4 Mhz clock

E4-E5 Connects 5 vdc to U6.26

For all other processor chips (U6):

E2-E3 Selects 8 Mhz clock

On PCBs with no staking pins you will need to cut the trace from E1-E2 and use jumper wire to connect E2-E3 to select the faster clock speed.

Tandy 1200 Captain multi-function board 25-3061 (figure 57):

The Captain board adds three functions to the Tandy 1200. RAM upgrade to 384K, a parallel port and a serial port. The switches and jumpers will have different positions depending on the way the board is configured. Multiple descriptions for the same jumper or switch will indicate the possible configurations.

Switch 1 positions 1-3 indicate the amount of RAM on the board as follows:

RAM	SW1-1	SW1-2	SW1-3
0K	ON	ON	ON
64K	OFF	ON	ON
128K	ON	OFF	ON
192K	OFF	OFF	ON
256K	ON	ON	OFF
320K	OFF	ON	OFF
384K	ON	OFF	OFF (standard)

SW1-4 OFF Addresses memory after the 256K on main logic board

SW1-5 ON Configures serial port as COM1 (standard)

OFF Configures serial port as COM2

SW1-6 ON Configures parallel port as LPT1

OFF Configures parallel port as LPT2 (standard)

SW1-7 ON Enables serial port (standard)

OFF Disables serial port

SW1-8 ON Selects TIME1 for LPT1 or TIME2 for LPT2 (standard)

OFF Disables parallel port

RAM Specification: 64K X 1 150nsec OR 200nsec BUT not both.

Note: These boards may come configured with 150 or 200 nsec RAMs installed. Both combinations will work, however care should be taken not to mix RAM. The board should contain ALL 150 or 200 nsec RAM.

(continued on next page)

TANDY COMPUTER PRODUCTS

JPR1 is a 15 pin block used to configure the serial port. The two standard configurations are for a modem or a serial printer.

Modem ---- 1-2, 3-4, 6-7, 8-9, 11-12, and 13-14 (standard)
 Printer -- 2-3, 4-5, 7-8, 9-10, 12-13, and 14-15

JPR2 2-3 Selects RS-232 type serial input (standard)
 1-2 Selects current loop type serial input

JPR3 1-2 Selects IRQ3 line for serial port COM2
 2-3 Selects IRQ4 line for serial port COM1
 4-5 Selects IRQ5 line for clock/calendar
 5-6 Selects IRQ7 line for clock/calendar

Standard configuration for JPR3 is 2-3 and all others off.

Tandy 1000 memory plus board 25-1011 (figure 81):

E1-E2 ON Selects one bank, or row, of RAM
 OFF Selects two banks, or rows, of RAM
 E3-E4 ON Selects 64K RAM chips
 OFF Selects 256K RAM chips

Tandy 3000 2 MEG Memory Board 25-4030 (figure 103):

This memory board can range from 512K (.5 MEG) to 2 MEG in 512K increments. S1 is configured depending on which board position and amount of RAM on the board.

Set the start address of memory bank 0 by setting S1 positions 1-4. The dip switches are to be set on 1 megabyte boundaries depending upon whether the memory board is the 1st, 2nd, 3rd... or last (7th), memory board in the computer.

Board Pos.	S1				Start Address			
	S1-1	S1-2	S1-3	S1-4	Bank 0	Bank 1	Bank 2	Bank 3
First board	OFF	ON	ON	ON	100000	180000	200000	280000
	ON	OFF	ON	ON	200000	280000	300000	380000
Second board	OFF	OFF	ON	ON	300000	380000	400000	480000
	ON	ON	OFF	ON	400000	480000	500000	580000
Third board	OFF	ON	OFF	ON	500000	580000	600000	680000
	ON	OFF	OFF	ON	600000	680000	700000	780000
Fourth board	OFF	OFF	OFF	ON	700000	780000	800000	880000
	ON	ON	ON	OFF	800000	880000	900000	980000
Fifth board	OFF	ON	ON	OFF	900000	980000	A00000	A80000
	ON	OFF	ON	OFF	A00000	A80000	B00000	B80000
Sixth board	OFF	OFF	ON	OFF	B00000	B80000	C00000	C80000
	ON	ON	OFF	OFF	C00000	C80000	D00000	D80000
Seventh board	OFF	ON	OFF	OFF	D00000	D80000	E00000	E80000
	ON	OFF	OFF	OFF	E00000	E80000	F00000	F80000

(continued on next page)

TANDY COMPUTER PRODUCTS

S1 positions 5 and 6 select which banks contain memory chips. Set as follows:

S1-5 S1-6

ON	ON	If only Bank 0 contains memory chips.
OFF	ON	If Bank 0 and Bank 1 contain memory chips.
ON	OFF	If Bank 0, Bank 1, and Bank 2 contain memory chips.
OFF	OFF	If Bank 0, Bank 1, Bank 2, and Bank 3 contain memory chips.

S1-7 Not used

S1-8	Off	Main logic board of computer has 512K or 640K main memory
	On	Main logic board of computer has 1Meg

Tandy 1200 Graphics Tender board 25-3043 (figure 58):

Jumper blocks JPR1, JPR3, and JPR6 are factory defaults. JPR8 is the only user selectable option jumper.

JPR1	pins 1-2	jumpered
JPR3	pins 1-2	jumpered
JPR6		jumpered
JPR8	pins 1-2	selects color monitor
	pins 2-3	selects monochrome monitor

Tandy 1200 Graphics Master board 25-3044 (figure 59):

There are several different ways of jumpering the Graphics Master board depending on the type of monitor attached. The board is able to drive a color (RGB) monitor and a monochrome (composite) monitor. However only one can be the primary, or boot monitor, while the other will be the secondary monitor. Following are three most common combinations and the jumper configuration for them:

Color primary with optional monochrome secondary:

JPR1A, JPR1B, JPR1C, JPR4, JPR5 (middle two pins), JPR6 and SW1 (switch on back of board) in the down position.

Monochrome primary with optional color secondary:

JPR1A, JPR1B, JPR1C, JPR4, JPR5 (middle two pins), JPR6, JPR7, and SW1 (switch on back of board) in the up position.

Color attached to Graphics Master and monochrome attached to monochrome board:

JPR1A, JPR1C, JPR4, JPR5 (middle two pins), JPR6 and SW1 (switch on back of board) in the down position.

TANDY COMPUTER PRODUCTS

Dual Display Graphics Adapter Video Board 25-3045 (figure 116):

<u>Default Display Mode</u>	<u>SW1</u>	<u>SW2</u>	<u>Monitor Type</u>	<u>SW3</u>	<u>SW4</u>
Monochrome	On	Off	Composite	Off	On
Color	Off	On	Monochrome or RGB	On	Off
Emulation	Off	Off	IBM Enhanced	Off	Off
<u>Composite Monitor</u>	<u>SW5</u>		<u>SW6 is ALWAYS Off</u>		
Color	On				
Monochrome	Off				

Several examples are listed below to be used with switch explanations above:

Monitors	Mode	Type	Switches On	Switches Off
CM-2/4/10	Color	RGB	2,3	1,4,5,6
VM-2/4	Color	Composite	2,4	1,3,5,6
VM-3	Monochrome	Monochrome	1,3	2,4,5,6
VM-3	Emulation	Monochrome	3	1,2,4,5,6
Color TV	Color	Composite	2,4,5	1,3,6
RAM Specification:	256KX1	150nsec		

Dual Display Graphics Adapter Revision A 25-3045A (figure 153):

Monochrome Mode	Monitors
E1-E2 Off	VM-3/5
E4-E5 On	
E6-E7 On	

Color Mode	Monitors
E1-E2 On	CM-2/4/10/11 Color TV Monitor VM-2/4
E4-E5 On	
E6-E7 Off	

Deluxe Text Display adapter 25-3046 (figure 104):

This board is designed to be used with the CM-1 and VM-1 monitors. There are no jumpers on the display board. However the computer must be configured for this board as follows:

Tandy 1200: S1-5 OFF and S1-6 OFF

Tandy 3000 Standard: E2-E3 and Setup program configured as Monochrome.

Tandy 3000 Gate Array: E5-E6 and Setup program configured as Monochrome.

Deluxe Text Display Adapter Boards Revision B/C 25-3046B/C (figure 188):

These boards are identical except for the crystal at location U41.

The Revision B board works with CM-1 and VM-1 and has a 22.285 MHz crystal at location U41.

The Revision C board works with VM-5 and has a 14.31818 MHz crystal at location U41.

TANDY COMPUTER PRODUCTS

Deluxe Graphics Display Adapter 25-3047 (figure 105): This board is designed to be used with the CM-1 and VM-1 monitors. However it can be configured for other high resolution monitors. When more than one switch setting is given, the setting marked (standard) is for use with the CM-1 and VM-1 monitor.

S1	OFF	Board responds as both monochrome and color	(standard)
	ON	Board responds color adapter only	
S2	OFF	Along with S3 selects 25 KHz horizontal sync.	(standard)
S3	OFF	Along with S2 selects 25 KHz horizontal sync.	(standard)
S4	OFF	Vertical sync negative	(standard)
	ON	Vertical sync positive	
S5	OFF	Horizontal sync negative	(standard)
	ON	Horizontal sync positive	
S6	ON	Enables RED to be sent to display	(standard)
	OFF	Disables RED	
S7	ON	Enables GREEN to be sent to display	(standard)
	OFF	Disables GREEN	
S8	ON	Enables BLUE to be sent to display	(standard)
	OFF	Disables BLUE	

W7 Between lower two horizontal pins for all configurations.

EGA/CGA Graphics Adapter 25-3048 (figure 189):

Monitor type	Switch 1	Switch 2	Switch 3	Switch 4
VM-5 monochrome	Off	Off	On	Off
CM-5, CM-11 (standard RGB)	Off	Off	Off	On
EGM1 (enhanced RGB)	Off	On	On	Off
Default Mode at Power Up	Switch 5			
EGA Operation	Off			
Compatible Operation	On			

There are two jumpers on this board. The first jumper is labeled 2XX/3XX and should be jumpered as such on the two pins closest to the back of the board, where the video connectors are. This is the only supported setting for this jumper.

The second jumper is a normal/enhanced jumper. Place the jumper over the two upper pins (the Normal setting) when monochrome and standard RGB monitors are used, and the two lower pins (the Enhanced setting) when enhanced RGB monitors (EGA) are used.

(continued on next page)

TANDY COMPUTER PRODUCTS

Note: To use the Tandy 1000's on board color graphics adapter (which may be necessary for some unique software programs) without removing the EGA/CGA adapter, it is necessary to change the switch setting as follows:

Switch 1	Switch 2	Switch 3	Switch 4	Switch 5
Off	On	Off	On	Off

Be sure to connect the video signal cable to the Tandy 1000 RGB video output when operating in this mode. To resume use of the EGA/CGA adapter, simply reset the switches to their original settings, and reconnect the monitor to the EGA/CGA adapter board.

EGA/CGA Graphics Adapter Board Revision A 25-3048A (figure 190):

The EGA/CGA Graphics Adapter Board will support a VM5, CM5, CM11, and an EGM1.

Below is a compatibility Specification Chart:

	Monochrome Display	Color Display (RGB/CGA)	Enhanced Color Display (ECD/EGA)
Horizontal Scan Rate	18.432 KHz	15.750 KHz	21.850 KHz
Vertical Scan Rate	50 Hz	60 Hz	60 Hz
Video Band Width	16.275 MHz	14.318 MHz	16.257 MHz
Maximum Resolution	720 x 350	640 x 200	640 x 350

Switch settings if EGA/CGA Adapter is the **only** video board in the system:

SW1-1	SW1-2	SW1-3	SW1-4	
On	Off	Off	On	RGB 40 x 25
Off	Off	Off	On	RGB 80 x 25
Off	On	On	Off	EGA Hi Resolution
On	On	On	Off	EGA Low Resolution
Off	Off	On	Off	Monochrome

Switch settings for EGA/CGA Adapter as the **primary** video board and a color or monochrome video board as the **secondary** video board:

SW1-1	SW1-2	SW1-3	SW1-4	Primary Monitor	Secondary Monitor
Off	Off	Off	On	RGB 80 x 25	Monochrome
On	Off	Off	On	RGB 40 x 25	Monochrome
Off	On	On	Off	EGA Hi Resolution	Monochrome
On	On	On	Off	EGA Low Resolution	Monochrome
Off	Off	On	Off	Monochrome	RGB 80 x 25
On	Off	On	Off	Monochrome	RGB 40 x 25

(continued on next page)

TANDY COMPUTER PRODUCTS

Switch settings for EGA/CGA Adapter as the **secondary** video board and a color or monochrome video board as the **primary** video board:

SW1-1	SW1-2	SW1-3	SW1-4	Primary Monitor	Secondary Monitor
Off	On	Off	On	RGB 80 x 25	Monochrome
On	On	Off	On	RGB 40 x 25	Monochrome
Off	Off	On	On	Monochrome	EGA Hi Resolution
On	Off	On	On	Monochrome	EGA Low Resolution
Off	On	On	On	Monochrome	RGB 80 x 25
On	On	On	On	Monochrome	RGB 40 x 25

Switch settings for SW1-5 and SW1-6 determine the power on mode for the EGA/CGA Adapter board. SW1-7 and SW1-8 are reserved for future use and are both in the OFF position:

Power On Mode	Monitor Type	Switch Setting	
		SW1-5	SW1-6
EGA	All	On	On
MDA/HERC	EGA/Monochrome	Off	On
CGA	EGA/RGB	On	Off

Jumper settings

Jumper	Jumper Pins	Setting environment
P1	1 and 2*	EGA monitor attached
P1	2 and 3	RGB or monochrome monitor attached
P3	1 and 2*	Normal operation
P3	2 and 3	Select port #2
P3	4 and 5	When not using Automode
P3	5 and 6*	When using Automode
P3	7 and 8	When using SLOT 8 (IBM PC)
P3	8 and 9*	When not using SLOT 8
P3	10 and 11*	When using Automode
P3	11 and 12	When not using Automode

* Denotes factory settings

TANDY COMPUTER PRODUCTS

VGA Adapter Board 25-4043 (figure 191):

Dip Switches 1-4 set to the off position.

W1 pins 1-2

No other modes or switch and jumper configurations are supported at this time.

EGA-Enhanced Graphics Adapter Board 25-4037 (figure 149):

There is an eight-bit switch box on the Enhanced Graphics Adapter. Switches 1-4 determine the type of displays and display adapters installed in the system. Switches 5 and 6 serve no function. Switches 7 and 8 determine the type of monitor you have attached to the system.

There are two jumpers, J2 and J4. J4 will always be set on the right two horizontal pins, looking at the video board component side, right side up. J2 will be set to the right two horizontal pins for CGA, Monochrome or 400 line Tandy monitors, and set to the left two horizontal pins for EGA, again looking at the video board component side, right side up.

Standard switch and jumper settings for an EGM1 monitor are:

SW1-1	SW1-2	SW1-3	SW1-4	SW1-5	SW1-6	SW1-7	SW1-8	J2	left two pins
Off	On	On	Off	On	On	On	Off	J4	right two pins

Standard switch and jumper settings for a CM-1 monitor are:

SW1-1	SW1-2	SW1-3	SW1-4	SW1-5	SW1-6	SW1-7	SW1-8	J2	right two pins
Off	On	On	Off	On	On	Off	On	J4	right two pins

Further information for additional setups are given below.

Switch settings if EGA Adapter is the **only** video board in the system:

SW1-1	SW1-2	SW1-3	SW1-4	
Off	Off	On	Off	Monochrome monitor
On	Off	Off	On	Color Monitor (40 x 25)
Off	Off	Off	On	Color Monitor (80 x 25)
On	On	On	Off	Enhanced Color Monitor (Normal 8 x 8 Text)
Off	On	On	Off	Enhanced Color Monitor (HiRes 8 x 14 Text)

Switch settings for EGA Adapter as the **primary** video board and a Monochrome Adapter as the **secondary** video board:

SW1-1	SW1-2	SW1-3	SW1-4	EGA Adapter	Monochrome Adapter
On	Off	Off	On	Color Monitor (40 x 25)	Monochrome Monitor
Off	Off	Off	On	Color Monitor (80 x 25)	Monochrome Monitor
On	On	On	Off	Enhanced Color Monitor with normal 8 x 8 text	Monochrome Monitor
Off	On	On	Off	Enhanced Color Monitor with HiRes 8 x 14 text	Monochrome Monitor

(continued on next page)

TANDY COMPUTER PRODUCTS

Switch settings for EGA Adapter as the **secondary** video board and a Monochrome Adapter as the primary video board:

SW1-1	SW1-2	SW1-3	SW1-4	EGA Adapter	Monochrome Adapter
On	On	On	On	Color Monitor (40 x 25)	Monochrome Monitor
Off	On	On	On	Color Monitor (80 x 25)	Monochrome Monitor
On	Off	On	On	Enhanced Color Monitor with normal 8 x 8 text	Monochrome Monitor
Off	Off	On	On	Enhanced Color Monitor with HiRes 8 x 14 text	Monochrome Monitor

Switch settings for EGA Adapter as the **primary** video board and a Color/graphics Adapter as the secondary video board:

SW1-1	SW1-2	SW1-3	SW1-4	EGA Adapter	Color/graphics Adapter
On	Off	On	Off	Monochrome Monitor	Color Monitor (40 x 25)
Off	Off	On	Off	Monochrome Monitor	Color Monitor (80 x 25)

Switch settings for EGA Adapter as the **secondary** video board and a Color/graphics Adapter as the primary video board:

SW1-1	SW1-2	SW1-3	SW1-4	EGA Adapter	Color/Graphics Adapter
On	On	Off	On	Monochrome Monitor	Color Monitor (40 x 25)
Off	On	Off	On	Monochrome Monitor	Color Monitor (80 x 25)

Switches 7 and 8 are as follows:

SW1-7	SW1-8	
On	Off	For EGA, CGA or Monochrome Monitor
Off	On	For 440 line, 25KHz Monitor (CM-1, VM-1)

RS-232 Plus Interface Board for Tandy MS-DOS computers 25-1014 (figure 106):

There are two versions of this board. One board is a domestic version which cannot be altered and is used for domestic operations only. Domestic operations means that the board transmits and receives at the same baud rate. The other board is an international version which can be used as either a domestic board or easily modified to accommodate international operations. International operations means that the board can be programmed to transmit at one baud rate while receiving at another baud rate.

Domestic operation:

E2-E3	Selects primary address (03F8-03FF)
E1-E2	Selects secondary address (02F8-02FF)
E4-E6	Connects 'OUT1*' to 'RATE' (DB-25 pin 23)
E7-E9	Connects 'BAUDOUT' to 'RCLK'

International operation:

E2-E3	Selects primary address (03F8-03FF)
E1-E2	Selects secondary address (02F8-02FF)
E4-E5	Connects 'OUT1*' to second baud rate generator logic
E7-E8	Connects 'BAUDOUT' to second baud rate generator logic
E9-E10	Connects second baud rate clock to receiver clock input

TANDY COMPUTER PRODUCTS

Plus RS232 25-1031 (figure 140):

Dip Switch SW1

		Address	Position 1	Position 2	Position 3	Position 4
COM1	IRQ4	3F8-3FF	Off	Off	Off	On
COM2	IRQ3	2F8-2FF	Off	On	Off	On
COM3	IRQ4	3E8-3EF	On	Off	Off	On
	IRQ2		On	Off	On	On
COM4	IRQ3	2E8-2EF	On	On	Off	On
	IRQ5		On	On	On	On

Setting all the switches to Off will disable interrupt signal.

Domestic Operation

E9-E11 Jumpered
E5-E7 Jumpered

International Operation

E8-E10 Jumpered
E4-E6 Jumpered
E1-E3 Jumpered

Tandy 2000 Serial Expansion Board 26-5164 (figure 92):

E1-E2 Enables DMA transmit requests
E3-E4 Enables DMA receive requests
E5-E6 Selects board as first board in system
E5-E7 Selects board as second board in system
E8-E10 Selects active low 'BUSINT03'
J29 1-2
J30 1-2
J5 through J10 1-2 Selects Port D for DTE operation (See Table Below)
2-3 Selects Port D for DCE operation "
J11 through J16 1-2 Selects Port C for DTE operation "
2-3 Selects Port C for DCE operation "
J17 through J22 1-2 Selects Port B for DTE operation "
2-3 Selects Port B for DCE operation "
J23 through J28 1-2 Selects Port A for DTE operation "
2-3 Selects Port A for DCE operation "

Following are the DB-25 signal changes for DTE and DCE operation:

DB-25 Pin	DTE signal	DCE signal
2	TXD	RXD
3	RXD	TXD
4	RTS	CTS
5	CTS	RTS
8	DCD	DTR
20	DTR	DCD

TANDY COMPUTER PRODUCTS**Vianet (figure 71 and figure 114):**

There are currently two versions of the Vianet (Arcnet) board for the 1000/1200/3000 machines. Figure 71 shows the Arcnet-PC and figure 114 shows the Arcnet-PC100. The jumpers and switches used are labeled identically on both boards. Only the location of the jumpers are changed. For this reason only one description is given for both boards. Please refer to the appropriate figure for the physical location of the jumpers.

	Tandy 1000	Tandy 1200	Tandy 3000/HL
JP1 = IRQ7	Default LPT1	Default LPT1	Default LPT1
JP2 = IRQ5	Vertical Sync	Default Hard Drive	Default LPT2
JP3 = IRQ4	Default COM1	Default COM1	Default COM1
JP4 = IRQ3	Default COM2	Default COM2	Default COM2
JP5 = IRQ2	Default Hard Drive	Vianet Standard	Vianet Standard

Important Note: Only ONE of JP1 through JP5 should be on.

JP1 through JP5 select the interrupt request line the Vianet board will use. The above table shows the default uses of these interrupt lines on each machine. When selecting which interrupt to use the entire system must be taken into account. For example; on the Tandy 1000 if there is no hard drive installed then JP5 would be the logical choice for the Vianet board. However if the computer has a hard drive then JP4 or JP3 must be used. This means of course that the associated COM port can not be used for a serial or modem board. Switches SW1-6 set the Base I/O Port address. SW7-10 set the Memory Segment Address.

	SW1-1	SW1-2	SW1-3	SW1-4	SW1-5	SW1-6	
Tandy 1000/ALL	Off	Off	On	Off	Off	On	= I/O port 360H
Tandy 1200	Off	Off	On	Off	Off	On	= I/O port 360H
Tandy 3000/ALL	Off	Off	On	Off	Off	On	= I/O port 360H
Tandy 4000/ALL	Off	Off	On	Off	Off	On	= I/O port 360H

	SW1-7	SW1-8	SW1-9	SW1-10	
Tandy 1000	Off	Off	Off	On	= base address E000H
Tandy 1200	Off	Off	Off	On	= base address E000H
Tandy 3000/ALL	Off	Off	On	Off	= base address D000H
Tandy 4000/ALL	Off	Off	On	Off	= base address D000H
Tandy 1000TX/TL	Off	Off	On	Off	= base address D000H

NOTE: The Vianet software (VIANET.BAT) must be modified for use with the Tandy 3000 & 3000HL to properly point to the different base address (D000H).

SW2 sets the ID or node number for the machine, which must be different for each computer attached to the Vianet system.

Vianet for Tandy 2000 26-1220 (figure 72):

S1 sets the ID number for the unit, which must be different for each machine in the system. NOTE: All switches set to 0 is an illegal condition.

TANDY COMPUTER PRODUCTS

Serial/Parallel Board Revision "A" 25-4034 (figure 102):

There are new ways of configuring LPT port addresses and assignments which will affect the jumpering configurations of boards related to parallel ports.

REFER TO TECHNICAL BULLETIN INFO:26 FOR FURTHER DETAILS ON CONFIGURING THIS BOARD WITH THE 25-3049 MONOCHROME PARALLEL BOARD TOGETHER OR THE NEWER COMPUTERS (i.e., 4020/25/33LX series).

E1-E3 Selects USA Standard baud-rate generator (standard)
 E1-E2 & Selects International baud-rate
 E3-E4 Selects International baud-rate

E6-E7 Selects parallel port 1 (LPT1) address 378-37F (standard)
 E5-E6 Selects parallel port 2 (LPT2) address 278-27F

E9-E10 Selects serial port 1 (COM1) address 3F8-3FF (standard)
 E8-E9 Selects serial port 2 (COM2) address 2F8-2FF

Serial/Parallel Board Revision "B" and "C" 25-4034 (figure 115):

There are new ways of configuring LPT port addresses and assignments which will affect the jumpering configurations of boards related to parallel ports.

REFER TO TECHNICAL BULLETIN INFO:26 FOR FURTHER DETAILS ON CONFIGURING THIS BOARD WITH THE 25-3049 MONOCHROME PARALLEL BOARD TOGETHER OR THE NEWER COMPUTERS (i.e., 4020/25/33LX series).

E1-E3 Selects USA Standard baud-rate generator (standard)
 E1-E2 & Selects International baud-rate
 E3-E4 Selects International baud-rate

PORT SELECTION

<u>LPT1</u>		<u>COM1</u>	
E6-E7	Selects address 378-37F	E9-E10	Selects address 3F8-3FF
E11-E12	Enables IRQ7	E15-E16	Enables IRQ4
<u>LPT2</u>		<u>COM2</u>	
E5-E6	Selects address 278-27F	E8-E9	Selects address 2F8-2FF
E13-E14	Enables IRQ5	E17-E18	Enables IRQ3

Multi-Terminal Board for the Tandy 3000 25-4031 (figure 117):

SW1 selects the Base I/O address as follows:

	<u>SW1-1</u>	<u>SW1-2</u>	<u>SW1-3</u>	<u>SW1-4</u>	<u>I/O Address</u>
1st Board	Off	Off	Off	On	100H
2nd Board	Off	Off	On	Off	104H
3rd Board	Off	On	Off	Off	108H

SW2 selects the Interrupt Request line as follows:

(continued on next page)

TANDY COMPUTER PRODUCTS

	SW2-1	SW2-2	SW2-3	SW2-4	SW2-5	SW2-6	SW2-7	SW2-8	Interrupt
1st Board	Off	Off	Off	Off	On	Off	Off	Off	IRQ10
2nd Board	Off	Off	Off	Off	Off	On	Off	Off	IRQ11
3rd Board	Off	Off	Off	Off	Off	Off	On	Off	IRQ12

The Baud Rate Clocks are set with the following jumpers:

A1-A2	Channel 1 uses on board clock
B1-B2	Channel 2 uses on board clock
L1-L2	Channel 3 uses on board clock
M1-M2	Channel 4 uses on board clock

Each of the four channels can be configured for either Data Communications Equipment (DCE) mode or Data Terminal Emulation (DTE) mode. When connecting to Tandy computers or terminals the DCE mode should be selected. When connecting to Tandy modems the DTE mode should be selected. For non Tandy equipment consult the individual equipment's owner manual for proper mode selection. The jumpering for each mode is as follows:

Data Communications Equipment (DCE)

<u>Channel 1</u>	<u>Channel 2</u>	<u>Channel 3</u>	<u>Channel 4</u>
D2-D3	G2-G3	P2-P3	W2-W3
D5-D6	G5-G6	P5-P6	W5-W6
E1-E3	H1-H3	T1-T3	X1-X3
E2-E4	H2-H4	T2-T4	X2-X4
F1-F2	K1-K2	V1-V2	Z1-Z2
F3-F4	K3-K4	V3-V4	Z3-Z4
F5-F6	K5-K6	V5-V6	Z5-Z6
F7-F8	K7-K8	V7-V8	Z7-Z8

Data Terminal Emulation (DTE)

<u>Channel 1</u>	<u>Channel 2</u>	<u>Channel 3</u>	<u>Channel 4</u>
D1-D2	G1-G2	P1-P2	W1-W2
D4-D5	G4-G5	P4-P5	W4-W5
E3-E4	H3-H4	T3-T4	X3-X4
E5-E6	H5-H6	T5-T6	X5-X6
F1-F5	K1-K5	V1-V5	Z1-Z5
F3-F7	K3-K7	V3-V7	Z3-Z7
F4-F8	K4-K8	V4-V8	Z4-Z8

Tandy 1000EX/HX Memory PLUS Expansion Adapter 25-1062 (figure 123):

E1-E2 Selects 128K RAM installed only

E2-E3 Selects 256K RAM installed also for total of 384K RAM

RAM Specification: U9-U12 64K X 4 150nsec
U1-U8 256K X 1 150nsec

TANDY COMPUTER PRODUCTS

Floppy/Hard Drive WD1002-WA2 Controller Board 25-4060 (figure 95):

E2-E3 Selects primary address for floppy (standard)
 E1-E2 Selects secondary address for floppy
 E5-E6 Selects primary address for hard drive (standard)
 E4-E5 Selects secondary address for hard drive
 E7-E8 Connects floppy read data into VCO

Floppy/Hard Drive WD1003-WA2 Controller Board 25-4060 (figure 124):

E2-E3 Selects primary address for floppy (standard)
 E1-E2 Selects secondary address for floppy
 E5-E6 Selects primary address for hard drive (standard)
 E4-E5 Selects secondary address for hard drive
 E8-E9 Supports 300 RPM floppy disk drives
 E7-E8 Connects floppy read data into VCO

1000EX/HX External Floppy Disk Interface in 25-1060/1 External Disk Drives 25-1060 (figure 125):

E1 +5 Volt Line
 E2 +12 Volt Line
 E3-E4 Ground Return Line

Plus Network 4 Interface 25-1019 (figure 126):

J1 Off IR5, IR4, IR2
 On IR3
 SW1 Sets station number of the unit. Treat the switch as a binary counter with position 1 being the LSB and position 6 being the MSB.
 Off = "1"
 On = "0"
 Example: 1 Off 2-6 on station number is 1
 6 Off 1-5 on station number is 32

Each computer in the system must have its own unique station number with number 63 being reserved for the primary disk server station.

Tandy 1000 300 Baud Modem board 25-1003 (figure 53):

E1 pins 2-3 Selects hook relay for single line phone
 E2 pins 1-2 Selects primary UART address (3F8-3FF)
 Note: E2 pins 2-3 would select secondary UART address (2F8-2FF)

1200 Baud Internal Modem Board 25-1013/A/B/C (figure 82):

SW1-1 OPEN Disables forced carrier detect (standard)
 CLOSED Enables forced carrier detect
 SW1-2 OPEN Enables auto answer
 CLOSED Disables auto answer (standard)
 SW1-3 OPEN Selects address COM2
 CLOSED Selects address COM1 (standard)
 SW1-4 OPEN Disables Tandy 1000 speaker (standard)
 CLOSED Enables Tandy 1000 speaker

TANDY COMPUTER PRODUCTS

1200 Baud Internal Modem 25-1013D/E (figure 192):**Interrupt Settings**

IRQ 4 (Com 1) - CN5 closed CN4 open
 IRQ 3 (Com 2) - CN4 closed CN5 open

Port Selection Settings

Com 1 - CN6 open
 Com 2 - CN6 closed

Multi-line phone system jumper

CN3 open - default setting
 CN3 closed - for use with older 1A2
 multi-line phone systems.

Dip Switch Settings & Self Test

SW1 off - True carrier detect
 SW1 on - Forced carrier detect

SW5 off - Numeric result codes
 SW5 on - Verbal result codes

SW2 off - True DTR
 SW2 on - Forced DTR

SW6 off - Command recognition on
 SW6 on - Command recognition off

SW3 off - Auto answer disabled
 SW3 on - Auto answer enabled

SW7 off - Send result codes
 SW7 on - Send no result codes

SW4 off - Command echo on
 SW4 on - Command echo off

Self Test - AT S16=1 D <ENTER>
 Causes local loop back of characters

PLUS 1200 Baud Modem 25-1018 (figure 127):**Dip Switch Position:**

- | | | |
|---|-----------|--|
| 1 | On | COM1 port; I/O address range 3F8-3FF |
| | Off | COM2 port; I/O address range 2F8-2FF |
| 2 | Not used. | |
| 3 | On | Uses carrier detect signal from remote modem. |
| | Off | Sets carrier detect signal set to logic 1. |
| 4 | On | DTR bit ignored. |
| | Off | Uses DTR to hang up modem when on line and return to command mode. |

NOTE: On=Down Off=Up

TANDY COMPUTER PRODUCTS

1200 Baud Half Card Modem 25-1018A (figure 193):

Interrupt Settings

IRQ 4 (Com 1) - CN6 closed CN5 open
IRQ 3 (Com 2) - CN5 closed CN6 open

Port Selection Settings

Com 1 - CN 4 open
Com 2 - CN 4 closed

Multi-line phone system jumper

CN3 open - default setting
CN3 closed - for use with older 1A2
multi-line phone systems.

Dip Switch Settings & Self Test

SW1 off - True carrier detect	SW5 off - Numeric result codes
SW1 on - Forced carrier detect	SW5 on - Verbal result codes
SW2 off - True DTR	SW6 off - Command recognition on
SW2 on - Forced DTR	SW6 on - Command recognition off
SW3 off - Auto answer disabled	SW7 off - Send result codes
SW3 on - Auto answer enabled	SW7 on - Send no result codes
SW4 off - Command echo on	Self Test - AT S16=1 D <ENTER>
SW4 on - Command echo off	Causes local loop back of characters

2400 Baud Half Card Modem Board 25-1037/A (figure 194):

Com Port Settings

CN4 open - Com 1
CN4 closed - Com 2

Interrupt Settings

IRQ4 (Com 1) - CN5 closed CN6 open
IRQ3 (Com 2) - CN5 open CN6 closed

Auto-Answer Operation

CN7 open - Auto answer enabled
CN7 closed - Auto answer disabled

Multi-line Phone Settings

CN3 open - Standard phone line
CN3 closed - 1A2 multi-line operation

(continued on next page)

TANDY COMPUTER PRODUCTS

Self-Test Mode

Load and run a terminal program.

When ready type: AT&T1 <ENTER>

Modem responds with: OK

All characters typed will be locally echoed.

To exit the test type: +++

Do not hit <ENTER>. Wait one second. The modem will respond with: OK

Type: AT&Ø

The modem again responds with OK. Normal operation may ensue.

14ØØLT Internal Modem Board 25-351Ø (figure 195):

The 25-351Ø modem has one jumper. It is labeled as W1. It is only set when an older 1A2 multi-line phone system is in use. It connects the A and A1 leads of the station wire together to enable the busy lamp for the CO line it is connected to.

To self test the modem type in the command:

AT S16=1 C1 D<CR>

The modem will respond:

CONNECT

Each key pressed will be echoed back to the screen.

To exit the test enter:

+++

Do NOT enter <CR> after +++.

Enhanced Keyboard Adapter 25-1Ø3Ø (figure 128):

On When connecting an IBM PC/XT compatible keyboard

Off When connecting an IBM AT compatible keyboard

Enhanced Keyboard 25-4Ø38 (figure 129):

4 position dip switch

Computer	Position 1	Position 2	Position 3	Position 4
Tandy 3ØØØ (AT Types)	On	On	XX	XX
Tandy 12ØØ (XT Types)*	On	Off	XX	XX
Tandy 1ØØØ (AT Mode)	On	On	XX	XX
Tandy 1ØØØ (XT Mode)	On	Off	XX	XX

XX=Don't Care

* Not officially supported

TANDY COMPUTER PRODUCTS

Dual Port Serial Board 25-4039 (figure 130):

SW1 settings

Serial Port 1	Pos 1	Pos 2	Serial Port 2	Pos 3	Pos 4
COM 1	On	On	COM 1	On	On
COM 2	On	Off	COM 2	On	Off
COM 3	Off	On	COM 3	Off	On
COM 4	Off	Off	COM 4	Off	Off

The "X"s below represent jumper pins. The jumper would go up and down and correspond to the appropriate IRQ setting labeled below. Refer to figure 130 for further clarification.

X X X X
 X X X X Serial Port 1

X X X X
 X X X X Serial Port 2

I I I I
 R R R R
 Q Q Q Q
 2 3 4 5

W1 Serial Port 2

Ring Jumpered for modem or computer communication
 +5V Jumpered for use with mouse

W2 Serial Port 1

Ring Jumpered for modem or computer communication
 +5V Jumpered for use with mouse

Note: When using this board in a Tandy 1000SL/SL2/TL/TL2, COM 3 will not work. **Three "COM" channels are not supported with these machines, but will work provided that COM 3 is not used.** Two combinations have been known to function. One would be to disable the on board serial chip select using the appropriate SETUP program and jumper the dual port serial board for COM 1 and COM 2. The other would be to leave the main board set up as COM 1 and jumper the dual port serial board as COM 2 and COM 4.

Plus 300 Baud Modem 25-1017 (figure 131):

CN2
 1-2 Single line (Standard)
 2-3 Multi line

(continued on next page)

TANDY COMPUTER PRODUCTS

Dip Switch SW1 settings when using Tandy Communications Software.

Note: * denotes default settings Tandy mode

1	On	Forced DTR
	* Off	True DTR
2	On	Forced Carrier
	* Off	True Carrier
3	Not used	
4	Not used	
5	Not used	
6	On	Auto Answer Enable
	* Off	Auto Answer Disable
7	* On	Selects Tandy Protocol
	Off	Selects Hayes Protocol
8	On	COM 2
	* Off	COM 1

Dip Switch SW1 settings when using Hayes Communications Software.

Note: * denotes default settings for Hayes mode

1	On	Forced DTR
	* Off	True DTR
2	On	Forced Carrier
	* Off	True Carrier
3	* On	Verbal Result Codes
	Off	Numeric Result Codes
4	On	No Result Codes
	* Off	Send Result Codes
5	On	Command Echo Off
	* Off	Command Echo On
6	* On	Auto Answer Disable
	Off	Auto Answer Enable
7	On	Selects Tandy Protocol
	* Off	Selects Hayes Protocol
8	On	COM 2
	* Off	COM 1

Etherlink I Original Style 26-5435 (figure 145):

Note: Whenever a standard or default configuration is changed the system **MUST** be reconfigured for the new jumper arrangement.

Interrupt jumpers

2	Selects interrupt 2
3	Selects interrupt 3 (Standard)
4	Selects interrupt 4
5	Selects interrupt 5
6	Selects interrupt 6
7	Selects interrupt 7

(continued on next page)

TANDY COMPUTER PRODUCTS

DMA ACK Jumpers

- 1 Selects DMA Channel 1 (Standard)
- 2 Selects DMA Channel 2
- 3 Selects DMA Channel 3

DMA REQ Jumpers

- 1 Selects DMA Channel 1 (Standard)
- 2 Selects DMA Channel 2
- 3 Selects DMA Channel 3

DMA ACK and REQ must be jumpered for the same DMA Channel.

The text below deals with jumper locations with 3 vertical pins per location. Only two of the pins should be jumpered. To aid in jumper configuration we will define:

Down=Two pins towards edge card connector (towards bottom of PCB)

Up =Two pins away from edge card connector (towards top of PCB)

Memory Address Jumpers for address of EC00H

12	13	14	15	16	17	18	19
Down	Down	Up	Up	Down	Up	Up	Up

This address can apply to any machine as long as there is no other address conflict in the system.

I/O Address Jumpers for address of 300H

4	5	6	7	8	9	MEM EN
Down	Down	Down	Down	Up	Up	Up
0	0	0	0	1	1	Address of 300H

The I/O Address Jumpers 4-9 may be configured for address range from 0 to 03F0H.

Up=1 Down=0 9=MSB

Etherlink I "Late Style" 26-5435 (figure 249):

Note: Whenever a standard or default configuration is changed the system MUST be reconfigured for the new jumper arrangement.

Interrupt jumpers

- 2 Selects interrupt 2
- 3 Selects interrupt 3 (Standard)
- 4 Selects interrupt 4
- 5 Selects interrupt 5
- 6 Selects interrupt 6
- 7 Selects interrupt 7

(continued on next page)

TANDY COMPUTER PRODUCTS

Note: There are 2 sets of pins for each DMA channel, both MUST be jumpered.

DMA Jumpers

- 1 Selects DMA Channel 1 (Standard)
- 2 Selects DMA Channel 2
- 3 Selects DMA Channel 3

The text below deals with jumper locations with 3 pins per location. Only two of the pins should be jumpered. To aid in jumper configuration the boards are silk screened \emptyset and 1

Memory Address Jumpers for address of EC00H (Default)

12	13	14	15	16	17	18	19
\emptyset	\emptyset	1	1	\emptyset	1	1	1

This address can apply to any machine as long as there is no other address conflict in the system.

I/O Address Jumpers for address of 300H (Default)

4	5	6	7	8	9	MEM EN
\emptyset	\emptyset	\emptyset	\emptyset	1	1	DIS

BNC/DIX should be set to BNC (Default)

The I/O Address Jumpers 4-9 may be configured for address range from \emptyset to \emptyset 3F0H.

Left=1 Right= \emptyset 9=MSB

Etherlink II 26-5501 (figure 210):

There are two sets of jumpers detailed below:

Jumper Set 1 is a 5 position jumper block and sets the memory base address. Options are Disable, DC000H, D8000H, CC000H and C8000H. Standard setting is the Disable option.

Set 2 is a 8 position jumper block and sets the I/O base address. Options are 300H, 310H, 330H, 350H, 250H, 280H, 2A0H and 2E0H. Standard setting is 300H.

Note: To change the interrupt or DMA channel, a software change must also be made using a network software utility program.

TANDY COMPUTER PRODUCTS

Etherlink Plus 26-5502 (figure 146):

The default jumper settings are for DMA channel 1, Interrupt 3, and I/O Base Address 0300H. Note that the symbols on the board itself are upside down compared to our figure 146.

DMA Channel Jumpers - Jumpers are attached vertically (two per channel under the appropriate number) for the desired DMA channel.

Interrupt Jumpers - Jumper is attached vertically above the jumper blocks marked INT below the appropriate number for the interrupt number desired.

I/O Base Address - For these jumpers, placing the jumper on the left two pins represents a logic "1" while placing the jumpers on the right two jumpers represents a logic "0". To change the address, decode into binary the address bits of the address you wish to use, to determine where a logic "1" will be needed (placing the jumper on the left two jumper pins) and where a logic "0" will be needed (placing the jumper on the right two jumper pins). 0300H and 0330H are shown below as examples. Bits 3, 2, 1, and 0 are set to "0" by default.

<u>Jumper Settings</u>	<u>I/O Address Bits</u>									
	9	8	7	6	5	4	3	2	1	0
Possible Values	1/0	1/0	1/0	1/0	1/0	1/0	0	0	0	0
Factory Settings	1	1	0	0	0	0	0	0	0	0
Equivalent HEX Value	3		0				0			

<u>Jumper Settings</u>	<u>I/O Address Bits</u>									
	9	8	7	6	5	4	3	2	1	0
Possible Values	1/0	1/0	1/0	1/0	1/0	1/0	0	0	0	0
0330H Settings	1	1	0	0	1	1	0	0	0	0
Equivalent HEX Value	3		3				0			

The memory address jumpers, configuration jumpers, A15 and A16 jumpers along with the test jumper, are set as shown in figure 146 and should not be changed.

The DIX-BNC jumper should be set on the lower group of pins for a BNC (also known as CO-AXIAL) cable, and on the upper group of pins for DIX cable.

Tandylink/PLUS boards 26-5601/2 (figure 198):

Factory settings for the TandyLink board are as follows:

Base address	398
DRQ setting	1
DACK setting	1
Interrupt request	2

(continued on next page)

TANDY COMPUTER PRODUCTS

The following table illustrates jumper settings for available Base Addresses:

Address	Settings	Settings	Settings
310	E4 & E5	E1 & E2	E7 & E8
318	E4 & E5	E1 & E2	E8 & E9
350	E4 & E5	E2 & E3	E7 & E8
358	E4 & E5	E2 & E3	E8 & E9
390	E5 & E6	E1 & E2	E7 & E8
398	E5 & E6	E1 & E2	E8 & E9 (default setting)
3D0	E5 & E6	E2 & E3	E7 & E8
3D8	E5 & E6	E2 & E3	E8 & E9

DRQ - is originally set to DRQ1 (E10-E11). To change to DRQ3 move the jumper to E11-E12.

DACK - is originally set to DACK1 (E14-E15). To change to DACK3 move the jumper to E13-E14

IRQ - is originally set to IRQ2 (E17-E18). To change to IRQ3 move the jumper to E16-E17.

ARNET Smartport 4/8 Port Board 90-2185/6 (figure 196 and figure 197):

Arnet boards are in that group of multiterminal boards which are addressed as COM devices. Usually, they are installed with the first board located at COM3, the second board at COM4, and so forth. The software drivers available for this board type in this system will recognize Arnet boards installed as COM1, COM2, COM3, COM4, COM5, and COM6 - however, you generally should not install them at COM1 or COM2!

If you install an Arnet board at COM1 or COM2, you will be unable to use the serial port on the serial/parallel board at that location.

Even if you configure the first Arnet board at COM3, you will still have room for 4 boards total... which is as much expansion as you would possibly want on a computer. So, the switch settings for standard installations will be:

First Board:

Switch 1: I/O Address COM3 (0100h - 010Fh) -- positions 1-4, 6 on
position 5 off

Switch 2: Memory address E00000h -- positions 1-5 on
positions 6-8 off

Switch 3: IRQ selection (none used) -- positions 1-10 off

(continued on next page)

TANDY COMPUTER PRODUCTSSecond Board:

Switch 1: I/O Address COM4 (0180h - 018Fh) -- positions 1-3, 6 on
 positions 4-5 off
 Switch 2: Memory address E20000h -- positions 1, 3-5 on
 positions 2, 6-8 off
 Switch 3: IRQ selection (none used) -- positions 1-10 off

If you should need to install a third or fourth board, and there is not more than 8 meg of memory installed in the AT series computer, you may use these settings:

Third Board:

Switch 1: I/O Address COM5 (01A0h - 01AFh) -- positions 1, 3, 6 on
 positions 2, 4-5 off
 Switch 2: Memory address 800000h -- positions 1-7 on
 position 8 off
 Switch 3: IRQ selection (none used) -- positions 1-10 off

Fourth Board:

Switch 1: I/O Address COM6 (01B0h - 01BFh) -- positions 3, 6 on
 positions 1-2, 4-5 off
 Switch 2: Memory address C00000h -- positions 1-6 on
 positions 7-8 off
 Switch 3: IRQ selection (none used) -- positions 1-10 off

On all boards, the JP1 jumper should be in the "B" position.

Connector Boards:

Aside from the board which is installed inside an AT series computer, each Arnet board will also have a connector box, housing either one or two four-connector boards. This connector box is cabled to the internal board via shielded ribbon cable, and has jumpers which allow each port to be configured individually as DTE (Data Terminal Emulation, normally used to talk to modems) or DCE (Data Communications Equipment, normally used to talk to direct-connect terminals).

Each port has a group of staking pins which looks like this:

T/R	RTS/CTS	DTR/DSR	RI_DCD
2	3	3	<u>2</u>
o o	o o o o	o o o o	o o o
o o	o o o o	o o o o	o o o
<u>1</u>	<u>1</u> <u>2</u>	<u>1</u> <u>2</u>	<u>1</u>

(continued on next page)

TANDY COMPUTER PRODUCTS

For DTE use (or for a port which will be talking to a modem), your jumpers should look like this:

T/R	RTS/CTS	DTR/DSR	RI_DCD
2	3	3	<u>2</u>
o-o	o-o o o	o-o o o	o-o o
o-o	o-o o o	o-o o o	o-o o
<u>1</u>	<u>1</u> <u>2</u>	<u>1</u> <u>2</u>	<u>1</u>

The dashes connecting the "o" symbols (i.e. "o-o") indicate where the jumper is to be installed.

For DCE use (or for a port which will be talking to a terminal), your jumpers should look like this:

T/R	RTS/CTS	DTR/DSR	RI_DCD
2	3	3	<u>2</u>
o o	o o o-o	o o o-o	o o-o
! !			
o o	o o o-o	o o o-o	o o-o
<u>1</u>	<u>1</u> <u>2</u>	<u>1</u> <u>2</u>	<u>1</u>

ØK Memory Expansion Adapter for the 3ØØØNL 25-4Ø27 (figures 199 and 2ØØ):

There are two versions of this board. One with jumpers and one without. The board without jumpers looks very similar to the 5ØØØMC ØK memory expansion adapter board. The board/subassembly numbers are different as well as slight layout differences. Refer to the appropriate figures for the differences.

A ØK memory expansion adapter with E1-E2 jumpered will work in a computer with 2 memory expansion adapter slots present (since the 3ØØØNL only has one slot available for this type of memory board, this option (E1-E2) will not work with a 3ØØØNL).

E1-E2 2 memory expansion adapter slots present
E2-E3 1 memory expansion adapter slot present (standard)

TANDY COMPUTER PRODUCTS

ØK Memory Expansion Adapter for the 5ØØØMC 25-6Ø3Ø (figure 2Ø1):

There are no switches or jumpers on this board. The board must be fully populated with SIMMs, all of one type (either 256k by 9 bit or 1 MEG by 9 bit page mode 1ØØ ns SIMMS).

Permitted memory configurations in the Tandy 5ØØØMC are:

- 2 MEG: one memory adapter with 8 1ØØ ns 256k SIMMS
- 4 MEG: two memory adapters, each filled with 8 1ØØ ns 256k SIMMS
- 8 MEG: one memory adapter with 8 1ØØ ns 1 MEG SIMMS
- 16 MEG: two memory adapters, each filled with 8 1ØØ ns 1 MEG SIMMS

The only difference between the first and second memory board in the Tandy 5ØØØMC is the mounting bracket. The first board uses a mounting bracket secured with a screw concealed underneath the rear case bezel; the second board uses a microchannel bracket.

32 Bit Memory Board for the 4ØØØ/LX 25-5Ø29 and 25-5Ø3Ø (figure 2Ø2):

This board has no jumpers on it. It comes in two versions. Catalog number 25-5Ø29 which comes with no RAM installed in it, and 25-5Ø3Ø which is stuffed with 8 256K SIMMs making it a 2 MEG memory board. 1 MEG SIMMs may also be used which makes this board an 8 MEG memory board.

1 MB Memory Upgrade Board for 28ØØHD 25-3554 (figure 261):

There are no jumpers for this upgrade. This will increase the total memory to 2 MEG. The memory is LIM 4.Ø Expanded Memory compatible.

Memory Adapter for Tandy 4ØØØSX 25-493Ø (figure 26Ø):

See the chapter for the Tandy 4ØØØSX for correct jumpering and memory configurations for this memory upgrade board. Since this board is used in the 4ØØØSX which has two slots available either one or two boards should both be jumpered E1-E2.

- E1-E2 2 Memory Expansion slots present
- E2-E3 1 Memory Expansion slot present

Monochrome/Parallel Adapter Board 25-3Ø49 (figure 245):

There are new ways of configuring LPT port addresses and assignments which will affect the jumpering configurations of boards related to parallel ports. REFER TO TECHNICAL BULLETIN INFO:26 FOR FURTHER DETAILS ON CONFIGURING THIS BOARD TOGETHER WITH THE NEWER COMPUTERS (i.e., 4Ø2Ø/25/33LX series) OR OTHER BOARDS RELATED TO PARALLEL PORTS.

(continued on next page)

TANDY COMPUTER PRODUCTS

This board is designed to work with the VM-3 and VM-5 monochrome monitors. A parallel port is also present on this board. Remember to set the computer to monochrome prior to using this board. The only jumpers that are present are for the parallel port. The parallel port can be either LPT1 or LPT2. To make discussion of the jumpers easier, arbitrary jumper numbers have been assigned.

LPT1 (3BC) JUMPER 2 to 4 (Default)
 LPT2 (378) JUMPER 1 to 3 and 2 to 4
 LPT3 (278) JUMPER 1 to 3 (XT machines only)
 DISABLED JUMPER 1 to 2

This is a brief overview of the parallel port addressing scheme used by this board and the newer computers (i.e. 4020/25/33LX):

Parallel port	I/O Address	IRQ	Description
1	3B8-3BF	7	Mono/parallel board port
2	378-37F	7	Conventional LPT1 port
3	278-27F	5	Conventional LPT2 port

Xenix 2.3.x does not recognize the ports in the same way. It sees them like this:

Parallel port	Unix/Xenix
1	/dev/lp1
2	/dev/lp0
3	/dev/lp2

Tandy Faxmate board 25-3063 (figure 257):

The Tandy Faxmate allows your PC to communicate with any Group - III facsimile (fax) machine. It allows you to send, receive, schedule, print, and display faxes. It operates at 4800 bps. There are three switches for I/O Port Addressing. All other parameters are software configured.

Switch	Switch	Switch	Faxmate I/O Address
1	2	3	
UP	UP	UP	220-227
UP	UP	DN	260-267
UP	DN	UP	2A0-2A7
UP	DN	DN	2E0-2E7 (standard)
DN	UP	UP	320-327
DN	UP	DN	360-367
DN	DN	UP	3A0-3A7
DN	DN	DN	3E0-3E7

NOTE: Switches 4 and 5, if they are present must be DN

16 Bit VGA Adapter Board (figure 221):

The VGA adapter board is a half-card, 16-bit adapter and is fully IBM PS/2 VGA compatible. It is software compatible with programs written for VGA, MCGA, EGA, CGA, MDA, and Hercules graphics. The different modes may be entered using the VGA.EXE program from the Utilities diskette. Following are the switches and jumpers available:

SW1	1	on	for special multi-frequency displays
		* off	conventional VGA
	2	* on	enables all VGA modes on all monitors - this allows monochrome-mapped text modes to be used on color monitors, and color "shades of grey" modes to be used on monochrome monitors
		off	monochrome-mapped modes are not available on color monitors, and color-mapped modes are not available on monochrome monitors
	3	* off	not used
	4	* on	16-bit operation with AutoSense enabled
		off	8-bit operation with AutoSense disabled
W1		* on	jumped always
W2		* 1-2	enables 132 column text mode
		2-3	supports all signals on the Video Feature Connector

Note: * denotes default setting

If a secondary adapter is to be added, it must be configured as the second adapter, for only the VGA adapter can be the primary display device. You are allowed only one color and one monochrome adapter in the computer at one time in accordance with IBM PS/2 VGA compatibility (EX. if you add a CGA adapter and a CM-11, you must configure the VGA adapter for monochrome operation). The MODE.EXE command is used to select between the two adapters.

Error-Correcting 2400 baud Internal Modem 25-1034 (figure 253):

This modem uses the standard Hayes command set and has only one jumper set for communication port selection.

Upper pin pair - COM 2
Lower pin pair - COM 1 (default)

2400 baud Internal Modem for Tandy 1100FD 25-3538 (figure 255):

This modem uses the standard Hayes command set. There are no jumpers on this board. Use SETUP_11.COM to set the communication port for internal modem operation.

TANDY COMPUTER PRODUCTS**2400 baud Internal Modem for Tandy 1400 LT/FD/HD 25-3524 (figure 254):**

This modem uses the standard Hayes command set. There are no jumpers on this board. The modem can be used in any of the Tandy 1400 laptop computers. The Tandy 1400 must be configured for modem operation. Press <Ctrl><Alt><Ins> to access the configuration menu.

Tandy Arcnet Adapter Board 26-6505 (figure 251):

S1 Positions 1-8 select the Node ID of 0-256 Hex

Switch	8	7	6	5	4	3	2	1
Binary Equiv	128	64	32	16	8	4	2	1

S2 Positions 1-3 select the I/O base address

Switch	1	2	3	I/O address in HEX
	On	On	On	260
	On	On	Off	290
*	On	Off	On	2E0
	On	Off	Off	2F0
	Off	On	On	300
	Off	On	Off	350
	Off	Off	On	380
	Off	Off	Off	3E0

S2 Positions 4-8 select the RAM buffer base address

Switch	4	5	6	7	8	RAM address in HEX
	On	On	On	On	On	C0000
	On	On	On	On	Off	C0800
	On	On	On	Off	On	C1000
	On	On	On	Off	Off	C1800
	On	On	Off	On	On	C4000
	On	On	Off	On	Off	C4800
	On	On	Off	Off	On	C5000
	On	On	Off	Off	Off	C5800
	On	Off	On	On	On	CC000
	On	Off	On	On	Off	CC800
	On	Off	On	Off	On	CD000
	On	Off	On	Off	Off	CD800
*	On	Off	Off	On	On	D0000
	On	Off	Off	On	Off	D0800

(continued on next page)

TANDY COMPUTER PRODUCTS

On	Off	Off	Off	On	D1000
On	Off	Off	Off	Off	D1800
Off	On	On	On	On	D4000
Off	On	On	On	Off	D4800
Off	On	On	Off	On	D5000
Off	On	On	Off	Off	D5800
Off	On	Off	On	On	D8000
Off	On	Off	On	Off	D8800
Off	On	Off	Off	On	D9000
Off	On	Off	Off	Off	D9800
Off	Off	On	On	On	DC000
Off	Off	On	On	Off	DC800
Off	Off	On	Off	On	DD000
Off	Off	On	Off	Off	DD800
Off	Off	Off	On	On	E0000
Off	Off	Off	On	Off	E0800
Off	Off	Off	Off	On	E1000
Off	Off	Off	Off	Off	E1800

EXT 1,2 * Off No extended timeout
 On Selects extended timeout

ROM * Off No autoboot ROM installed
 On Autoboot ROM installed

IRQ 7 Selects interrupt 7
 5 Selects interrupt 5
 4 Selects interrupt 4
 3 Selects interrupt 3
 * 2 Selects interrupt 2

Note: * denotes default settings for Novell's Netware.

TANDY COMPUTER PRODUCTS

Tandy Ethernet Adapter Board 26-5505 (figure 248):

To help identify this board, on the solder side there are several stickers. One of these stickers will have a Western Digital ID number. The ID number for this board is WD8003EB. Refer to Technical Bulletin NETWORK:3 for more information on this and other Western Digital network adapter boards.

NOTE: The Superdisk that comes with the 26-5505 adapter is used for setting the configuration of the 26-5505 version adapter only. It must not be used with any other version of adapter.

W1	Off	Normal operation *
	On	Clear configuration
W3	BNC to center pin	Selects BNC connection *
	AUI to center pin	Selects AUI interface connection
	(Later revision boards have a double jumper for W3)	
W9 L	16K	\
	-- Selects 27128 ROM type *	
W9 R	16K/32K	/
W9 L	32K/64K	\
	-- Selects 27256 ROM type	
W9 R	16K/32K	/
W9 L	32K/64K	\
	-- Selects 27512 ROM type	
W9 R	64K	/

Tandy Token Ring Adapter 26-5540 (Figure 250):

J1	1-2	ROM enabled
	2-3	ROM disabled *
J2	1-2	Defines adapter as primary adapter *
	2-3	Defines adapter as secondary adapter in two adapter system
J3	1-2	Selects a 32K byte, 27256 type boot ROM *
	2-3	Selects a 64K byte, 27512 type boot ROM
J4	6-7	Selects IRQ2 *
	5-8	Selects IRQ3
	4-9	Selects IRQ4
	3-10	Selects IRQ5
	2-11	Selects IRQ6
	1-12	Selects IRQ7

(continued on next page)

TANDY COMPUTER PRODUCTS

J1Ø Jumper pack installed on J1ØA/1ØB \ --Selects RJ11-type port *
 Jumper pack removed from J1ØC /
 Jumper pack installed on J1ØC \ --Selects D-type port
 Jumper pack removed from J1ØA/1ØB /

Note: * denotes default settings

Tandy Ethernet Plus Adapter 26-55Ø6 (figure 282):

This board is packaged with a Superdisk software diskette. The diskette contains the Setup program, EZSETUP.EXE used to configure the various option settings of the board. The jumpers on the board only affect the options they are listed for. This Superdisk software diskette also contains software drivers for various operating systems and a diagnostic program, DIAGNOSE.EXE.

NOTE: The Superdisk software diskette (version 2.1 or later) that is packaged with this board will have the 26-55Ø6 catalog number on the label. It is to be used with this board only.

To help identify this board, on the solder side there are several stickers. One of these stickers will have a Western Digital ID number. The ID number for this board is WD8Ø13EP. Refer to Technical Bulletin NETWORK:3 for more information on this and other Western Digital network adapter boards.

W1	3ØØ.1Ø.CCØØØ	Sets the board to Base I/O address of 3ØØh, IRQ 1Ø, and RAM Base address CCØØØh.
	* 28Ø.3.DØØØØ	Sets the board to Base I/O address of 28Øh, IRQ 3, and RAM Base address DØØØØh.
	Soft	Settings for the board are determined by the EZSETUP.EXE program. I/O address = 24Øh.
W2	D8ØØØ	Selects 16K ROM Base address D8ØØØh - DBFFFh.
	* None/Soft	Selected if no ROM installed.
W3	* BNC to center pin	Selects BNC interface connector.
	AUI to center pin	Selects AUI interface connector.

NOTE: W3 is a double jumper option and both jumpers must be set for the same option.

* = Indicates Factory Setting

TANDY COMPUTER PRODUCTS

Tandy Ethernet Adapter Board 26-5505A/B (figure 285)

This board is packaged with a Superdisk software diskette. The diskette contains a Setup program, EZSETUP.EXE used to configure the various option settings of the board. The jumpers on the board only affect the options they are listed for. This Superdisk software diskette also contains software drivers for various operating systems and a diagnostic program, DIAGNOSE.EXE.

NOTE: The Superdisk software diskette that is packaged with the 26-5505A adapter can be used for setting the configuration of the 26-5505A version or the 26-5505 version adapter board. It must be Version 2.0 or greater.

NOTE: The Superdisk software diskette that is packaged with the 26-5505B can be used for setting the configuration of the 26-5505, 26-5505A, and 26-5505B

NOTE: Some Superdisks for the 26-5505B were labeled 2.0, but the correct version of 2.1B is actually on the disk. To verify that the disk you have is version 2.1B, read the README.DOC file located in the root directory for the disk. The version number 2.1B should be displayed at the beginning of the text. If no version number appears or any version less than 2.1B, do not use the disk to setup the 26-5505B board.

To help identify this board, on the solder side there are several stickers. One of these stickers will have a Western Digital ID number. The ID number for this board is WD8003EP. Refer to Technical Bulletin NETWORK:3 for more information on this and other Western Digital network adapter boards.

W1	280,3,D0000 *	Sets the board to Base I/O address of 0280h, IRQ3, and RAM Base address of D0000h.
	300,5,CA000	Sets the board to Base I/O address of 0300h, IRQ5, and RAM Base Address of CA000h.
	Soft	Settings of board determined by EZSETUP program.
W2	D8000	Selects 16K ROM at Base Address D8000 - DBFF0h.
	None/Soft *	Selected if no ROM is installed or allows the ROM size and Base Address to be set by EZSETUP program.
W3	BNC to center pin *	Selects BNC connector.
	AUI to center pin	Selects AUI connector.

Note: W3 is a double jumper option and both jumpers must be set for the same option.

* indicates default settings

TANDY COMPUTER PRODUCTS

Tandy 2400-BPS Half Card Modem 25-1037B (figure 291):

The available settings for the 2400 BPS Half Card Modem are controlled by a slide switch at the rear of the card. This switch is accessible for operation while the card is installed in the computer.

SW-1 Down Sets the modem for COM1.

SW-1 Up Sets the modem for COM2.

1200 Baud Internal Modem 25-1013F (figure 281):

J3 Jumper on the center and right pins selects the Auto-Answer mode.

* Jumper on the center and left pins disables Auto-Answer mode.

SW1 COM1 position selects COM channel 1

COM2 position selects COM channel 2

All other modem parameters are software selectable.

2400 Baud Modem for the 1500HD/2810HD/3810HD laptop 25-3525 (figure 280):

There are no jumpers for this modem. It is installed beneath the two inch wide access panel adjacent to the battery. The modem is connected to the main logic board via a single flat cable and secured in position upside down with two screws.

2400 BAUD Internal Modem Board for 2800HD 25-3555 (figure 279):

There are no jumpers for this upgrade. Note however that you must run SETUP_28 to verify that the serial devices are enabled.

Dual Serial/Parallel Board 25-4025 (figure 286):

This board has two serial ports and one parallel port. Serial port 1 can be configured for COM 1, COM 2, COM 3, or disabled. Serial port 2 can be configured for COM 2, COM 3, COM 4, or disabled. The parallel port may be configured for LPT 2, LPT 3, or disabled.

There are new ways of configuring LPT port addresses and assignments which will affect the jumpering configurations of the boards related to parallel ports. REFER TO TECHNICAL BULLETIN INFO:26 FOR FURTHER DETAILS ON CONFIGURING THIS BOARD IN A MULTI-PARALLEL PORT CONFIGURATION. Jumper settings are given below. An asterisk (*) indicates factory settings.

(continued on next page)

TANDY COMPUTER PRODUCTSConfiguring serial port 1

	<u>J6</u>	<u>J5</u>	<u>J3</u>
COM 1 (3F8h, IRQ4):	* up	up	up
COM 2 (2F8h, IRQ3):	up	down	down
COM 3 (3E8h, IRQ3 or 4):	down	up	down=IRQ3 up=IRQ4
Disabled	down	down	no effect

Ring indicator power source * W1 = upper 2 pins: ring indicator
W1 = lower 2 pins: +5 volts

Configuring serial port 2

	<u>J8</u>	<u>J7</u>	<u>J2</u>
COM 2 (2F8h, IRQ3):	* up	up	up
COM 3 (3E8h, IRQ6):	up	down	down
COM 4 (2E8h, IRQ3 or 6):	down	up	down=IRQ6 up=IRQ3
Disabled	down	down	no effect

Ring indicator power source * W2 = upper two pins: ring indicator
W2 = lower two pins: +5 volts

Configuring the parallel port

	<u>J10</u>	<u>J9</u>	<u>J1</u>
LPT 2 (378h, IRQ7):	* up	up	up
LPT 3 (278h, IRQ5):	down	up	down
Disabled	down	down	no effect

Bi-directional select * J4 = up: disabled
J4 = down: enabled

Dual Serial/Parallel Board Revision "A" 25-4025A (figure 287):

This board has two serial ports and one parallel port. Serial port 1 can be configured for COM 1, COM 2, COM 3, or disabled. Serial port 2 can be configured for COM 2, COM 3, COM 4, or disabled. The parallel port may be configured for LPT 2, LPT 3, or disabled.

There are new ways of configuring LPT port addresses and assignments which will affect the jumpering configurations of the boards related to parallel ports. REFER TO TECHNICAL BULLETIN INFO:26 FOR FURTHER DETAILS ON CONFIGURING THIS BOARD IN A MULTI-PARALLEL PORT CONFIGURATION. Jumper settings are given below. An asterisk (*) indicates factory settings. Up = the upper two pins are jumped. Down = the lower two pins are jumped. Off = the jumper is parked on one pin only, or removed completely.

(continued on next page)

TANDY COMPUTER PRODUCTS

Configuring serial port 1

<u>Address</u>	<u>J8</u>	<u>J7</u>
COM 1 (3F8h):	up	up
COM 2 (2F8h):	up	down *
COM 3 (3E8h):	down	up
Disabled	down	down (J2 and J3 settings have no effect)

<u>Interrupt</u>	<u>J2</u>	<u>J3</u>
IRQ2	off	up
IRQ3	up	off *
IRQ4	down	off
IRQ5	off	down

Ring indicator power source

W1 = upper two pins: ring indicator *
W1 = lower two pins: +5 volts

Configuring serial port 2

<u>Address</u>	<u>J10</u>	<u>J9</u>
COM 2 (2F8h):	up	up
COM 3 (3E8h):	up	down *
COM 4 (2E8h):	down	up
Disabled	down	down (J4 and J5 settings have no effect)

<u>Interrupt</u>	<u>J4</u>	<u>J5</u>
IRQ2	off	up
IRQ3	up	off
IRQ4	down	off
IRQ5	off	down *

Ring indicator power source

W2 = upper two pins: ring indicator *
W2 = lower two pins: +5 volts

Configuring the parallel port

<u>Address</u>	<u>J12</u>	<u>J11</u>
LPT 2 (378h):	up	up *
LPT 3 (278h):	down	up
Disabled	down	down

<u>Interrupt</u>	<u>J1</u>	<u>Bi-directional select</u>
IRQ5	down	J6 = up: enabled
IRQ7	off *	J6 = down: disabled *

TANDY COMPUTER PRODUCTS

ARNET Smartport 16 Port Board 90-2403 (figure 290):

Arnet boards are in that group of multiterminal boards which are addressed as COM devices. Usually, they are installed with the first board located at COM3, the second board at COM4, and so forth. The software drivers available for this board type in this system will recognize Arnet boards installed as COM1, COM2, COM3, COM4, COM5, and COM6 -- however, you generally should not install them at COM1 or COM2!

If you install an Arnet board at COM1 or COM2, you will be unable to use the serial port on the serial/parallel board at that location.

Even if you configure the first Arnet board at COM3, you will still have room for 4 boards total... which is as much expansion as you would possibly want on this machine. So, the switch settings for standard installations will be:

First Board:

Switch 1: I/O Address COM3 (0100h)	-- positions 1-4, 6 on position 5 off
Switch 2: Memory address E40000h	-- positions 1-2, 4-5 on positions 3, 6-8 off
Switch 3: IRQ selection (none used)	-- positions 1-10 off
Switch 4: Memory size/location (64K, 0 offset)	-- positions 1-4 off

Second Board:

Switch 1: I/O Address COM4 (0180h)	-- positions 1-3, 6 on positions 4-5 off
Switch 2: Memory address E60000h	-- positions 1, 4-5 on positions 2-3, 6-8 off
Switch 3: IRQ selection (none used)	-- positions 1-10 off
Switch 4: Memory size/location (64K, 0 offset)	-- positions 1-4 off

If you should need to install a third or fourth board, and there is not more than 8 meg of memory installed in the Tandy 4000, you may use these settings:

Third Board:

Switch 1: I/O Address COM5 (01A0h)	-- positions 1, 3, 6 on positions 2, 4-5 off
Switch 2: Memory address E80000h	-- positions 1-3, 5 on positions 4, 6-8 off
Switch 3: IRQ selection (none used)	-- positions 1-10 off
Switch 4: Memory size/location (64K, 0 offset)	-- positions 1-4 off

(continued on next page)

TANDY COMPUTER PRODUCTS

ARNET Octaport 8 Port Board 90-2458 (figure 289):

Arnet boards are in that group of multiterminal boards which are addressed as COM devices. Usually, they are installed with the first board located at COM3, the second board at COM4, and so forth. The software drivers available for this board type in this system will recognize Arnet boards installed as COM1, COM2, COM3, COM4, COM5, and COM6 -- however, you generally should not install them at COM1 or COM2!

If you install an Arnet board at COM1 or COM2, you will be unable to use the serial port on the serial/parallel board at that location.

Even if you configure the first Arnet board at COM3, you will still have room for 4 boards total... which is as much expansion as you would possibly want on this machine. So, the switch settings for standard installations will be:

First Board:

Switch 1: I/O Address COM3 (0100h)	-- positions 1-4, 6 on position 5 off
Switch 2: Memory address E00000h	-- positions 1-2, 4-5 on positions 3, 6-8 off
Switch 3: IRQ selection (none used)	-- positions 1-10 off

Second Board:

Switch 1: I/O Address COM4 (0180h)	-- positions 1-3, 6 on positions 4-5 off
Switch 2: Memory address E20000h	-- positions 1, 4-5 on positions 2-3, 6-8 off
Switch 3: IRQ selection (none used)	-- positions 1-10 off

If you should need to install a third or fourth board, and there is not more than 8 meg of memory installed in the Tandy 4000, you may use these settings:

Third Board:

Switch 1: I/O Address COM5 (01A0h)	-- positions 1, 3, 6 on positions 2, 4-5 off
Switch 2: Memory address E40000h	-- positions 1-3, 5 on positions 4, 6-8 off
Switch 3: IRQ selection (none used)	-- positions 1-10 off

(continued on next page)

TANDY COMPUTER PRODUCTS

Fourth Board:

Switch 1: I/O Address COM6 (01B0h) -- positions 3, 6 on
 positions 1-2, 4-5 off
 Switch 2: Memory address E60000h -- positions 1, 3, 5 on
 positions 2, 4, 6-8 off
 Switch 3: IRQ selection (none used) -- positions 1-10 off

1 MB Memory Expansion SIMM 25-3507 (figure 278):

There are no jumpers on this board. It is for the 1500/2810/3810 laptop computers. These SIMM modules are 1MB 80ns double-sided.

Serial/Parallel Converter 26-2829 (Figure 252):

Switch positions 1-3 select the baud rate

Switch	1	2	3	Baud Rate
	On	On	On	38400
	Off	On	On	16200
	On	Off	On	9600
	Off	Off	On	4800
	On	On	Off	2400
	Off	On	Off	1200
	On	Off	Off	600
	Off	Off	Off	300

Switch 4 Off Selects 7 bit character length
 On Selects 8 bit character length

Switch positions 5 and 6 select the parity

Switch	5	6	Parity
	Off	Off	None
	On	Off	Odd
	Off	On	Even
	On	On	Not used

Switch 7 Off XON/XOFF Mode
 On DTR Mode

Switch 8 Off Direction is from serial to parallel
 On Direction is from parallel to serial

TANDY COMPUTER PRODUCTS

Trackstar and Trackstar E Interface Board 25-1028/38 (figure 247):

The Trackstar interface board allows the 1000 family of computers to read or write to Apple compatible diskettes using specially modified Tandy 360K 5-1/4" disk drives. The Trackstar interface is able to coexist with 3-1/2" disk drives, but is not able to read or write 3-1/2" Apple diskettes. The modification procedure for the disk drives and the installation procedure for the Trackstar interface are outlined in Technical Bulletin I/O:114.

There are no switches or jumpers on this board.

- NOTES:
- o When used in the 1000SL, a special drive cable must be used (WF-0116).
 - o The 1000TX and 1000TL must be run in their 4MHz slow modes for the 80 character video mode to function properly.

16 Bit Super VGA Adapter Board (figure 298):

The VGA adapter board is a half-card, 16 bit adapter and is fully IBM PS/2 VGA compatible. It supports Super VGA modes with 132 column text and both 800 x 600 and 1024 x 768 resolution graphics. It comes with 512K of memory on board, and is capable of supporting both fixed frequency and multi-frequency monitors. Support for the Super VGA modes is accomplished by executing the VGA1024.EXE program from the Utilities diskette. Following are the switch and jumper options:

SW1	1	on	for special multi-frequency displays
		* off	conventional fixed frequency displays
	2	* on	enables all VGA modes on all monitors - this allows monochrome-mapped text modes to be used on color monitors, and color "shades of grey" modes to be used on monochrome monitors
		off	monochrome-mapped modes are not available on color monitors, and color-mapped modes are not available on monochrome monitors
	3	* off	not used
	4	* on	16-bit operation with AutoSense enabled
		off	8-bit operation with AutoSense disabled
W1		* on	enables normal operation using AutoSense jumped always

Note: * denotes default setting

CMS Tape Drive Mux Adapter 90-2405 (figure 277):

This board interfaces either an internal or an external jumbo tape drive (60 Meg TCS, 25-4079) to PC, XT and AT class computers. It may solve incompatibility problems between a floppy controller and a tape drive. With a CK80 cable (90-2406), it makes it possible to use two floppy drives and a 60 Meg tape drive. The tape drive can be installed internally if there is enough space in the computer, or externally. The adapter board has an extra connector on it for external tape drives.

All configuration information needed is handled through software: the board has no jumpers. Connectors are:

- J1 Connector from floppy controller
- J2 Connector to floppy drive
- J3 External tape drive connector
- J4 Internal tape drive connector

The recommended configuration is given below:

- 1> Use the CK80 cable (900-2406) to connect the main logic board and the first floppy drive (A:) to the J1 connector on the adapter board. The holes punched in the cable go between the a: drive and the adapter board.
- 2> Connect the internal tape drive cable to the J4 connector on the adapter board using the cable that comes with the tape drive.
- 3> Connect the second floppy drive to the J2 connector on the adapter board using the floppy drive cable that came with the machine.
- 4> Connect the power cables to the tape drive and the second floppy.

This page intentionally left blank.

```
*****
*
*
*           A P P E N D I X           *
*
*
*****
```

TANDY COMPUTER PRODUCTSTRS-DOS SYSTEM FLOPPY DRIVE USAGE (8")

Drive Model	Capacity	II	Exp. Bay	12/16/16B	Thin Bay	6000
Shugart SA800	500K	Yes				
CDC Discrete	500K		Yes			
CDC LSI	500K		Yes			
TPI 8"	500K	Yes	Yes			
Tandon 8"	500K/1M			Yes	Yes	Yes
Tandon TM848-2E	500K/1M			Yes	Yes	Yes

TRS-DOS UPGRADE BOARD USAGE

Upgrade Board	Figure(s)	II	16	12/16B	6000
Arcnet	28	Yes	Yes	Yes	Yes
Visicalc	12	Yes	Yes	Yes	Yes
144K RAM	13, 14	Yes	Yes	Yes	Yes
Hi-Res Graphics	29	Yes	Yes	Yes	Yes
Multi-Terminal	31	Yes	Yes	Yes	Yes
68000 6 MHz CPU	16	Yes	Yes	Yes	
Reduced 68000 CPU	17	Yes	Yes	Yes	
68000 Memory	18	Yes	Yes	Yes	
8 MHz 68000 CPU	66	Yes	Yes	Yes	Yes
512K/1MEG 68000 RAM	67, 68	Yes	Yes	Yes	Yes
68000 MMU *	157,158/9	Yes	Yes	Yes	Yes

* Memory Management Unit - must have 8 MHz 68000 CPU to exchange for 68000 CPU with MMU modification installed.

TRS-DOS SYSTEM HARD DRIVE USAGE

Hard Drive	INT = Internal		EXT = External			
	Model	II	12	16	16B	6000
5 MEG Tandon	TM602	EXT	EXT	EXT	EXT	EXT
8 MEG Shugart	SA1004	EXT *1	EXT *1	EXT *1	EXT *1	EXT *1
10 MEG Tandon	TM502					EXT
10 MEG Tandon	TM252					EXT
12 MEG Tandon	TM603	EXT	EXT	EXT	EXT	EXT
15 MEG Tandon	TM503	EXT	EXT	EXT	INT/EXT	INT/EXT
35 MEG Quantum	*2 Q540	EXT	EXT	EXT	EXT	EXT
70 MEG Micropolis	*2 1325	EXT	EXT	EXT	EXT	EXT

NOTE: *1. A special 8 MEG interface board is required which is not compatible with the other hard drives.

*2. Maximum TRSDOS 4.2.5 and 4.2.6 is 16.6 Megabytes.

3. TRSDOS Version 4.2.5 is for the WD1010 controller.
TRSDOS Version 4.2.6 is for the 8x300 controller.

TANDY COMPUTER PRODUCTS

TRSDOS HARD DRIVES USED IN MS-DOS COMPUTERS

CATALOG	DESCRIPTION	MODEL #	HEADS	CYL	SETUP TYPE
26-5103	10 MEG Tandon	TM502	4	306	1
25-1025	10 MEG Tandon	TM252	4	306	1
26-4155	15 MEG Tandon	TM503	6	306	41 *1
26-4171	35 MEG Quantum	Q540	8	512	36 *2
26-4173	70 MEG Micropolis	1325	8	1024	40 *3

NOTES:

1. In older ROM versions that do not have a drive type 41, use drive type 1.
2. In older ROM versions that do not have a drive type 36, use drive type 7.
3. In older ROM versions that do not have a drive type 40, use drive type 4.

MS-DOS SYSTEM FLOPPY DRIVE USAGE (5 1/4")

Drive Model	Capacity	1000	1000TL/TL2	1200HD	2000	4000 SERIES	4016SX/20SX
Tandon TM100-2	360K			Yes			
Tandon TM65-2L	360K			Yes*3			
TEAC FD-54B	360K	Yes					
TEAC FD55BV-75	360K	Yes	Yes *1				
TEAC FD55BV-221	360K	Yes	Yes *1				
TEAC FD55BR-521	360K	Yes	Yes *1		Yes		Yes
TEAC FD55BR-121	360K	Yes	Yes *1		Yes		Yes
Mitsu. M4853	720K			Yes			
Mitsu. M4853-1	720K			Yes			
Mitsu. M4851	360K				Yes		Yes
Mitsu. MF501A	360K				Yes		Yes
Mitsu. M4854-3S	1.2M				Yes *2		Yes
Mitsu. MF504A/B	1.2M				Yes *2		Yes
Mitsu. MF504C	1.2M				Yes *2		Yes

Note: *1. Can only be used as external drive with Tandy 1000HX.

*2. When installed into a Tandy 3000HL a Dual Speed Floppy Drive Controller or Floppy/Hard Drive Controller is required.

*3. Used in 1200A only.

TANDY COMPUTER PRODUCTS

MS-DOS SYSTEM FLOPPY DRIVE USAGE (3 1/2")

Drive Model	Capacity	1000HX	1000TL/TL2	4016SX/20SX	4000LX	5000MC
Teac FD-35-FN	720K	Yes *2				
Teac 235F-105U	720K		Yes *6			
Sony MP-F63W-01D	720K	Yes *7	Yes *5		Yes *5	
Sony MP-F63W-70D	720K	Yes *7	Yes *5		Yes *5	
Sony MP-F11W-70D	720K		Yes *3	Yes	Yes *3	Yes
Sony MP-F11W-71	720K		Yes *3	Yes	Yes *3	Yes
Sony MP-F11W-72	720K		Yes *3	Yes	Yes *3	Yes
Teac 235HF-106U	1.44M			Yes	Yes *1 *3	Yes
Sony MP-F73W-01D	1.44M				Yes *1 *4	
Sony MP-F73W-70D	1.44M				Yes *1 *4	
Sony MP-F17W-70D	1.44M			Yes	Yes *1 *3	Yes
Sony MP-F17W-71	1.44M			Yes	Yes *1 *3	Yes
Sony MP-F17W-72	1.44M			Yes	Yes *1 *3	Yes

- Note: *1. When installed into a Tandy 3000HL a dual speed floppy drive controller or floppy/hard drive controller is required.
 *2. Used only as an external drive with Tandy 1000EX/HX.
 *3. Requires 3 1/2" to 5 1/4" drive adapter board (25-1076) for 720K drives in 1000/SX/TX, 1000SL/SL2 and 1.44M drives in 3000/HL and 4000/4000LX. All others do not require the adapter.
 *4. Used as 25-4052 upgrade kit in these computers as well as internal drive A: on Tandy 4000.
 *5. Used only in 1000/SX/TX, 3000/HL or 4000/4000LX. Requires 3 1/2" to 5 1/4" drive adapter board (25-1066).
 *6. Used only in 1000RL and 1000SL2.
 *7. Used internally in 1000HX. Not supported in 1000EX.

HARD DRIVES - HARD CARDS

Hard cards come as a hard drive with a controller board attached. When installing them in an AT style machine, the SETUP program should show no hard drives installed.

CAPACITY	CATALOG	SIZE	MANUFACTURER	Model	I/F	HEADS	CYLS.
20 MEG	25-1029	3.5"	Fuji	FK302-26	ST506	4	612
20 MEG	25-1029	3.5"	Fuji	FK305-26	ST506	4	612
20 MEG	25-1029A/B	3.5"	Miniscribe	8438	ST506	4	612
20 MEG	25-1032	3.5"	Tandon	TM362	ST506	4	615
20 MEG	25-1032A/B	3.5"	Western Dig.	WD362	ST506	4	615
20 MEG	25-1032CDE	3.5"	Western Dig.	WD93028	IDE	2	782
40 MEG	25-4059	3.5"	Seagate	ST157R	ST506	6	522
40 MEG	25-4059A	3.5"	Western Dig.	WD344R	ST506	4	782
40 MEG	25-4059B	3.5"	Western Dig.	WD93044	IDE	4	782

TANDY COMPUTER PRODUCTSHARD DRIVES - ST-506 HARD DRIVES

Early BIOS ROMs contained hard drive lookup tables designed to match up to hard drives of the time period. These ROM lookup tables did not have as many choices as later BIOS ROM lookup tables. With later versions of BIOS ROMs, the drive type lookup tables were expanded to include an expanding list of drives as well as more specific drive types for earlier hard drives.

The EARLY ROM type number listed below refers specifically to Tandy 3000/HL computers with 1.00.00 and 1.01.00 BIOS ROMS.

The LATER ROM type number listed below refers to Tandy 3000/2500/4000 series computers with 1.02.00 BIOS ROMS or later installed. MS-DOS 3.20.02 or later must be used with 1.02.00 BIOS ROMS.

CAPACITY	CATALOG	MANUFACTURER	Model	HEADS	CYLS.	!EARLY ROM	!LATER ROM!
						!TYPE #	!TYPE #
20 MEG	25-4062	Mitsubishi	MR522	4	612	6	6
20 MEG	25-4062	Seagate	ST225	4	615	2	2
40 MEG	25-4061A	Rodime	RO3055	6	820	3	39
40 MEG	25-4140	Seagate	ST-151	5	977	N/A *3	N/A *3
40 MEG	25-4061	CDC	WREN II	5	989	11	37
40 MEG	25-4061	Microscience	HH-1050	5	1024	11	38
40 MEG	25-4057	Seagate	ST251	6	820	3	39
70 MEG	25-4067	Rodime *1	R05090	7	1224	14	19
80 MEG	25-4141	CDC	94355	9	1072	N/A *2	N/A *2

Notes:

- *1. The floppy/hard drive controller WD1002-WA2 will only support 1024 cylinders. To format the complete drive, a WD1003-WA2 floppy/hard drive controller or a 25-4058 hard drive only controller must be used.
- *2. Used in the Tandy 5000MC only. Refer to the 5000MC hard drive type table for the correct setup type.
- *3. Used only in the 5000MC. Use drive type 43 in the 5000MC hard drive type table. To do this, BIOS ROM version 1.02.02 or greater is needed.

TANDY COMPUTER PRODUCTS**HARD DRIVES - IDE HARD DRIVES**

The table below shows the head and cylinder counts that are derived from a translate table within the intelligence of the IDE ROM/Controller. The actual number of heads and cylinders is different.

CAPACITY!	CATALOG !	MANUFACTURER!	Model !	I/F !	HEADS !	CYLS. !	SETUP TYPE!
20 MEG	25-1045	Western Dig.	WD93028	XT	2	782	Note 5
40 MEG	25-1046	Western Dig.	93044	XT	4	782	Note 5
20 MEG	25-1047	Seagate	ST-325X	XT	4	615	Note 5
40 MEG	25-1048	Seagate	ST-351A/X	Note 4	5	980	17
40 MEG	25-4119	Miniscribe	8051A	AT	5	977	17
40 MEG	25-4119	Miniscribe	7040A	AT	5	977	17
40 MEG	25-4123	Conner	CP3044	AT	5	977	17
52 MEG	25-4124	Quantum	LPS52	AT	8	751	Note 1
80 MEG	25-4120	Miniscribe	7080A	AT	10	981	Note 2
105 MEG	25-4130	Quantum	LPS105	AT	16	755	Note 3

Notes:

1. Refer to the Hard Drive chapter, page 62 for SETUP type information.
2. Refer to the Hard Drive chapter, page 51 for SETUP type information.
3. Refer to the Hard Drive chapter, page 63 for SETUP type information.
4. Can be set to either interface type, depending on jumper settings. Refer to Hard Drive chapter, page 61 for jumper information. Drive type given is for AT jumper setup.
5. Setup drive types are not applicable to XT style computers.

SCSI HARD DRIVE HEAD AND CYLINDERS

SCSI hard drive head and cylinder counts will be different depending on the version of SCSI BIOS ROM. Some are based on 16 heads and some are based on 64 heads. Refer to Technical Bulletin HD:51 for further details. Below are the heads and cylinders count for the SCSI hard drives based on either number of heads, along with other important information. This information will be useful when using DISKREL and figuring out partition information. Select "NO HARD DRIVE INSTALLED" for a SCSI hard drive, unless there is a "SCSI" selection available.

Catalog	MANUFACTURER	Model #	Size	SCSI Drive!	16 HEAD BIOS	64 HEAD BIOS!	HEADS	CYL.	HEADS	CYL.
25-4159	Quantum	P40S	40 Meg		16	160	64	40		
25-4160	Quantum	Q280	80 Meg		16	305	64	77		
25-4160A	Quantum	P80S	80 Meg		16	305	64	77		
25-4162	Seagate/CDC	94221	170 Meg		16	684	64	171		
25-4164	Seagate	ST1239N	220 Meg*		16	778	64	194		
25-4163	Seagate/CDC	94171	344 Meg		16	1251	64	313		
25-4167	Seagate	ST2502N	440 Meg*		16	1661	64	415		

(continued on next page)

TANDY COMPUTER PRODUCTS

***NOTE:** As of the date of this printing, DISKREL only supports SCSI hard drive head/cylinder counts for the 40, 80, 170, and 344 Megs.

For the 202 MEG SCSI hard drive use the 170 MEG selection.
 For the 440 MEG SCSI hard drive use the 344 MEG selection.

HARD DRIVE TYPE TABLE

To determine your drive type, compare the number of cylinders and the number of heads for your drive with the numbers in the following table. If you can not find an exact match, use a type with the correct number of heads but fewer cylinders. Types 1-15 are available with 1.00.00 and 1.01.00 BIOS ROMS installed in a Tandy 3000/HL. Drive types 16-24 and 36-41 were added in later BIOS ROM versions. Drive types 25-29 and 35 are even newer additions and may not be found in all BIOS ROM versions. Consult your setup table specific to your computer for correct drive types.

HARD DRIVE TYPES

Type	Cylinders	Heads	Type	Cylinders	Heads
1	306	4	19	1024	7
2	615	4	20	733	5
3	615	6	21	733	7
4	940	8	22	733	5
5	940	6	23	306	4
6	615	4	24	** Reserved **	
7	462	8	25	615	4
8	733	5	26	1024	4
9	900	15	27	1024	5
10	820	3	28*	981	10
11	855	5	29	512	8
12	855	7	35	1023	9
13	306	8	36	512	8
14	733	7	37	989	5
15	** Reserved **		38	1024	5
16	612	4	39	820	6
17	977	5	40	1024	8
18	977	7	41	306	6

* Drive type 28 will be different depending on the particular ROM version of the computer. Some have 8 heads and 1024 cylinders; others have 10 heads and either 977 cylinders or 981 cylinders. Refer to the hard drive type table in the appropriate setup program for the computer to determine which drive type 28 is available. Then refer to the hard drive note entry in the chapter on hard drives to determine the correct drive type for that hard drive.

TANDY COMPUTER PRODUCTS

TANDY 5000MC Hard Drive Type Table

	!# of! !Cyl.!	!# of! !Hds.!	!start write! !precomp. ! ! cylinder	!head ! landing ! cylinder	!number of !sectors !per track	! drive type
HDPARM	306	4	128	305	17	1
HDPARM	615	4	300	615	17	2
HDPARM	615	6	300	615	17	3
HDPARM	940	8	512	940	17	4
HDPARM	940	6	512	940	17	5
HDPARM	615	4	-1	615	17	6
HDPARM	462	8	256	511	17	7
HDPARM	733	5	-1	733	17	8
HDPARM	900	15	-1	901	17	9
HDPARM	820	3	-1	820	17	10
HDPARM	855	5	-1	855	17	11
HDPARM	855	7	-1	855	17	12
HDPARM	306	8	128	319	17	13
HDPARM	733	7	-1	733	17	14
HDPARM	000	0	000	000	00	15
HDPARM	612	4	0	633	17	16
HDPARM	977	5	300	977	17	17
HDPARM	977	7	-1	977	17	18
HDPARM	1024	7	512	1023	17	19
HDPARM	733	5	300	732	17	20
HDPARM	733	7	300	732	17	21
HDPARM	733	5	300	733	17	22
HDPARM	306	4	0	336	17	23
HDPARM	612	4	305	633	00	24
HDPARM	306	4	-1	340	17	25
HDPARM	612	4	-1	670	17	26
HDPARM	698	7	300	732	17	27
HDPARM	976	5	488	977	17	28
HDPARM	306	4	0	340	17	29
HDPARM	611	4	306	663	17	30
HDPARM	732	7	300	732	17	31
HDPARM	1023	5	-1	1023	17	32
HDPARM	000	0	000	000	00	33
HDPARM	000	0	000	000	00	34
HDPARM	1023	9	1023	1023	17	35
HDPARM	1023	5	512	1023	17	36
HDPARM	830	10	-1	830	17	37
HDPARM	823	10	256	824	17	38
HDPARM	615	4	128	664	17	39
HDPARM	615	8	128	664	17	40

(continued on next page)

TANDY COMPUTER PRODUCTS

TANDY 5000MC Hard Drive Type Table (continued)

	!# of! !Cyl.!	!# of! !Hds.!	!start write! !precomp. ! ! cylinder	! head ! landing ! ! cylinder	!number of ! !sectors ! !per track	! drive type
HDPARM	917	15	-1	918	17	41
HDPARM	1023	15	-1	1023	17	42
HDPARM	823	10	512	823	17	43
HDPARM	820	6	-1	820	17	44
HDPARM	1023	8	-1	1023	17	45
HDPARM	925	9	-1	925	17	46
HDPARM	699	7	256	700	17	47

TANDY COMPUTER PRODUCTS

MS-DOS UPGRADE BOARD USAGE

UPGRADE BOARD	FIGURE(S)	1000	SX/TX	1000	EX/HX	1200	2000	2500 SERIES	3000 SERIES	4000 SERIES
25-1003	300 Baud Modem	53	Yes	Yes *5	Yes	Yes	Yes	Yes		
25-1006	RS-232C	54	Yes	Yes *5	Yes	Yes	Yes	Yes		
25-1004/9	External RAM	55, 56	Yes			Yes*2				
25-1011	Memory Plus	81	Yes					Yes		
25-1013	1200 Baud Modem	82	Yes	Yes	Yes	Yes	Yes	Yes		
25-1013F	1200 Baud Modem	281	Yes	Yes	Yes	Yes	Yes	Yes		
25-1014	RS-232C Plus	106	Yes *4	Yes *4	Yes *4	Yes *3	Yes *3	Yes *3		
25-1017	Plus 300 Modem	131	Yes *3	Yes *3	Yes *4	Yes *3	Yes *3	Yes *3		
25-1018/A	Plus 1200 Modem	127, 193	Yes *3	Yes *3	Yes *3	Yes *3	Yes *3	Yes *3		
25-1019	Plus Network 4	126	Yes *3	Yes *3	Yes *3	Yes *3	Yes *3	Yes *3		
25-1028	Trackstar 128	247	Yes	Yes	Yes					
25-1030	E. KYBD Adapter	128	Yes	Yes						
25-1031	Plus RS232	140	Yes *3	Yes *3	Yes *4	Yes *3	Yes *3	Yes *3		
25-1034	2400 Baud ECR	253	Yes	Yes	Yes	Yes	Yes	Yes		
25-1037	2400 Baud Modem	194	Yes	Yes	Yes *5	Yes	Yes	Yes		
25-1037A/B	2400 Baud Modem	291	Yes	Yes	Yes *5	Yes	Yes	Yes		
25-1038	Trackstar E	247	Yes	Yes	Yes					
25-3043	Graphic Tendor	58				Yes	Yes	Yes		
25-3044	Graphic Master	59				Yes	Yes	Yes		
25-3045	Dual Display	116			Yes	Yes	Yes	Yes		
25-3045A	Dual Display "A"	153			Yes	Yes	Yes	Yes		
25-3046	Deluxe Text	104				Yes	Yes	Yes		
25-3047	Deluxe Graphics	105				Yes	Yes	Yes		
25-3048	EGA/CGA Adapter	189, 190		Yes	Yes	Yes	Yes	Yes		
25-3049	Mono/Parallel	245		Yes	Yes	Yes	Yes	Yes		
25-3061	Captain Multi.	57				Yes	Yes	Yes		
25-3063	Faxmate	257	Yes	Yes	Yes	Yes	Yes	Yes		
25-4025/A	Dual Serial/Par	286, 287	Yes	Yes *5	Yes	Yes	Yes	Yes		
25-4030	2 MEG Memory	103						Yes		

- NOTES: *1. Requires Enhanced Keyboard Adapter.
 *2. Can only use the second memory board, figure 56.
 *3. Must have Plus adapter board installed (25-1016).
 *4. Must have Memory Plus for the 1000, or Plus adapter for 1000 SX/TX.
 *5. SL/TL have on board serial ports which can be disabled with SETUP programs. These boards will work in the SL/TL series provided there are no COM or IRQ conflicts.

(continued on next page)

TANDY COMPUTER PRODUCTS

MS-DOS UPGRADE BOARD USAGE (cont.)

UPGRADE BOARD	FIGURE(S)	1000	SX/TX	1000	TL/RL	EX/HX	1200	2000	2500 SERIES	3000 SERIES	4000 SERIES
25-4031	Multi-Terminal	117									Yes
25-4034	Serial/Parallel	102, 115	Yes	Yes	Yes	*5		Yes			Yes
25-4037	EGA Board	149									Yes
25-4038	Enhanced Keyboard	129	Yes	*1	Yes						Yes
25-4039	Dual Port Serial	130	Yes	Yes	Yes	*5		Yes			Yes
25-4043	VGA adapter	191		Yes	Yes			Yes			Yes
25-4060	FD/HD Controller	95, 124									Yes
25-5435	Etherlink I Orig	145	Yes	Yes	Yes						Yes
25-5435	Etherlink I New	249	Yes	Yes	Yes						Yes
26-1221	Vianet PC	71, 114	Yes	Yes	Yes			Yes			Yes
26-1220	Vianet 2000	72							Yes		
26-5127	HD Controller	60							Yes		
26-5140	Hi-Res Mono.	61							Yes		
26-5140	Hi-Res Color	62							Yes		
26-5144	Mouse/Clock/Cal	65							Yes		
26-5161	External RAM	63, 64							Yes		
26-5164	Multi-Terminal	92							Yes		
26-5501	Etherlink II	210	Yes	Yes	Yes						Yes
26-5502	Etherlink Plus	146									Yes
26-5505	Ethernet	248	Yes	Yes	Yes						Yes
26-5505A	Ethernet Adapter	284	Yes	Yes	Yes						Yes
26-5505B	Ethernet Adapter	285	Yes	Yes	Yes						Yes
26-5506	Ethernet Plus	282									Yes
26-6505	Tandy Arcnet	251	Yes	Yes	Yes						Yes

- NOTES:
- *1. Requires Enhanced Keyboard Adapter.
 - *2. Can only use the second memory board, figure 56.
 - *3. Must have Plus adapter board installed (25-1016).
 - *4. Must have Memory Plus for the 1000, or Plus adapter for 1000 SX/TX.
 - *5. SL/TL have on board serial ports which can be disabled with SETUP programs. These boards will work in the SL/TL series provided there are no COM or IRQ conflicts.

TANDY COMPUTER PRODUCTSRAM REFERENCE GUIDE

This guide is NOT all inclusive of RAM chips that may be encountered, but was assembled from actual Tandy Corporation products in the interest of trying to make the list as comprehensive as possible. Most of these RAM chips are DIPs (Dual In-line Package).

Nomenclature	Organization	Access Time	
MT 1256-15	256K X 1	150 nsec	
MT 1257-15	256K X 1	150 nsec	
MT 1259-12	256K X 1	120 nsec	
MT 1259-15	256K X 1	150 nsec	
P 2164A-20	64K X 1	200 nsec	
MSM 3764-15RS	64K X 1	150 nsec	
MSM 3764-20RS	64K X 1	200 nsec	
MT 4065-12	64K X 4	120 nsec	
MT 4067-12	64K X 4	120 nsec	
MT 4067-15	64K X 4	150 nsec	
TMS 4116D20NL	16K X 1	200 nsec	
MCM 4116BP20	16K X 1	200 nsec	
TMS 4164-15NL	64K X 1	150 nsec	
TMS 4164-215NL	64K X 1	150 nsec	
TMM 4164AP-15	64K X 1	150 nsec	
KM 4164A-15	64K X 1	150 nsec	
KM 4164A-20	64K X 1	200 nsec	
KM 41256P-12H	256K X 1	120 nsec	
KM 41256-12	256K X 1	120 nsec	
KM 41256-15	256K X 1	150 nsec	
uPD 41256C-15	256K X 1	150 nsec	
KM 41257-15	256K X 1	150 nsec	
TMM 41464P-12	64K X 4	120 nsec	
TMM 41464-12	64K X 4	120 nsec	
M5M 4256J-10	256K X 1	100 nsec	RAM on Tandy 4000 256K X 9 SIMM
MT 4264-15	64K X 1	150 nsec	
TMS 4256-15NL	256K X 1	150 nsec	
TMS 4416-15NL	16K X 1	150 nsec	
MK 4564N-20	64K X 1	200 nsec	
HM 4864P-2	64K X 1	150 nsec	
HM 50256P-15	256K X 1	150 nsec	
P 51C256L-15	256K X 1	150 nsec	
MCM 6665AL20	64K X 1	200 nsec	
MCM 6665BP20	64K X 1	200 nsec	
TC 8040016	16K X 1	200 nsec	
TC 8040116	2K X 8	200 nsec	
TC 8040416	16K X 4	150 nsec	
TC 8040446	2K X 8	350 nsec	
TC 8040464	64K X 4	150 nsec	
TC 8040609	256K X 9	100 nsec	256K SIMM for Tandy 4000
TC 8040665	64K X 1	200 nsec	

(continued on next page)

TANDY COMPUTER PRODUCTSRAM REFERENCE GUIDE (Cont.)

TC	8041016	16K X 1	450 nsec	Model III
TC	8041116	2K X 8	200 nsec	
TC	8041254	64K X 4	150 nsec	
TC	8041464	64K X 4	120 nsec	
TC	8041509	1M X 9	100 nsec	1MEG SIMM for Tandy 4000
TC	8041665	64K X 1	150 nsec	
TC	8042665	64K X 1	200 nsec	Use In CC II ONLY
TC	8043665	64K X 1	150 nsec	Use In Tandy 1000 ONLY
TC	8044256	256K X 1	120 nsec	
TC	8045164	64K X 4	120 nsec	
TC	8046116	2K X 8	150 nsec	
TC	8046164	64K X 1	120 nsec	
TC	8049008	256K X 1	150 nsec	
TC	8049164	64K X 1	150 nsec	
MB	8264A-15	64K X 1	150 nsec	
SCM	9040016	16K X 1	200 nsec	Model II
TC	8041609	256K X 9	80 nsec	256K SIMM for 4000LX/5000MC
TC	8049010	1M X 9	80 nsec	1MEG SIMM for 4000LX/5000MC

SIMM (Single In-Line Memory Module) Identification Table

This table is intended to be a helpful reference guide to determine the type and size of SIMMs you are using. Some of these numbers may be date code information which will vary from one module to the next. Most of the numbers should match though, especially the numbers on the component side which for the most part are taken off the memory chips themselves.

This table includes as many manufacturers' types of SIMMs as possible at the present time. New types may be introduced in the future, therefore this list will be updated as time goes on.

	<u>Organization</u>	<u>Access Time</u>	<u>Markings</u> (component side)	<u>Markings</u> (solder side)	<u>Vendor#</u>
1) 9	256K x 1	100 nS	MT1259EJ-10	MT9259 M-10 Micron Technology	8040609
2) 9	256K x 1	100 nS	M5M4256AJ-10	MH25609J-10	8040609
3) 9	256K x 1	100 nS	OKI Japan M41256A 732353 101	OKI	8040609

(continued on next page)

TANDY COMPUTER PRODUCTS

<u>Organization</u>	<u>Access Time</u>	<u>Markings (component side)</u>	<u>Markings (solder side)</u>	<u>Vendor#</u>
4) 2 256K x 4	100 nS	OKI Japan M514256-10 932048	MSC2329-10YS3	8040609
1 256K x 1	100 nS	OKI Japan M41256A 932227102		
5) 9 256K x 1	80 nS	AAA2891H9S-08	NMBS MM2801J9S-08	8041609
6) 2 256K x 4	80 nS	Panasonic MN104256-80	No markings	8041609
1 256K x 1	80 nS	Japan 8902HAK TC1256P-80		
7) 9 1M x 1	100 nS	MALAYSIA 883950015K HM511000JP10S	GED10059P095	8041509
8) 9 1M x 1	80 nS	NEC Japan 421000-80 8840RY010	GED10059P095	8049010
9) 9 1M x 1	80 nS	JAPAN 8902HCK TC511000AJ-80	TOYOCOM TH3C10009-T80	8049010
10) 2 256K x 4	80 nS	PANASONIC MN41C4256SJ-08 JAPAN 905B4	1988 TANDY CORP S/A 8899074	8041609
1 256K x 1	80 nS	AAA2801J-08 NMBS 8931		
11) 9 256K x 1	80 nS	AAA2801J-08 NMBS 8820	NMBS SNK NST4 MM2801J9S-08 MADE IN JAPAN	8041609
12) 2 256K x 4	80 nS	MCM514256AJ80 UIQAA8914	1988 TANDY CORP S/A 8899074	8041609
1 256K x 1	80 nS	AAA2801J-08 NMBS 8911		
13) 2 256K x 4	100 nS	KM44C256AJ-10 925 KOREA	1988 TANDY CORP S/A 8899074	8040609
1 256K x 1	100 nS	MT1259EJ-10 8940 D USA		

TANDY COMPUTER PRODUCTS

TANDY/GRID CATALOG/MODEL NUMBER CROSS REFERENCE LIST

Note: Although the main logic boards may appear similar, most are NOT interchangeable. Consult the exchange lists for proper main logic board part numbers and DO NOT SUBSTITUTE one manufacturer's board for another.

TANDY Catalog #	TANDY Model #	GRiD Catalog #	GRiD Model #
25-3505	1400HD	G20-1010	140xt
25-3551	2810HD	G20-1720	1720
25-4074	2500XL	G51-1616	286mfp
25-4075	2500XL/2	G51-1617	286mfp svga
25-4072	3000NL	G51-1610	286is
		G51-1611	286is M40 (with 40 MEG HD)
		G51-1612	286is M80 (with 80 MEG HD)
25-4900	4000SX	G52-1640	386isx
		G52-1641	386isx M40 (with 40 MEG HD)
		G52-1642	386isx M80 (with 80 MEG HD)
		G52-1644	386isx (with 2 MEG memory)
25-4901	4016SX	G52-1643	386sxmfp
25-4903	4020SX	G52-1801	386sxmfp20
25-5001	4016DX	G53-1634	386is-16
25-5100	4000LX	G53-1630	386is
25-5120	4020LX	G53-1631	386is-20 (with 1 MEG memory)
		G53-1636	386is-20 (with 2 MEG memory)
25-5125	4025LX	G53-1632	386is-25 (with 2 MEG memory)
		G53-1638	386is-25 (with 4 MEG memory)
25-5133	4033LX	G53-1633	386is-33 (with 4 MEG memory)
		G53-1637	386is-33 (with 8 MEG memory)
25-6000	5000MC	G54-1620	386mc
		G54-1621	386mc M40 (with 40 MEG HD)
		G54-1622	386mc M80 (with 80 MEG HD)

MONITOR TYPE TABLE

Monochrome Composite	Monochrome Direct Drive	CGA	EGA	VGA
VM-2	VM-1	CM-1	EGM-1	VGM-100
26-3211	26-5111	25-5112	25-4035	25-4040
VM-4	VM-3	CM-2		VGM-200/B
25-1020	25-3010	26-3212		25-4041/B
	VM-5	CM-4/10		VGM-300/B
	25-3011	25-1021		25-4042/B
		25-1022		
	VM-5	CM-5		VGM-220
	25-3012	25-1023/A/B/C		25-4044
		25-1043/A		VGM-440
				25-4046
		CM-11		
		25-1024/A		

TANDY COMPUTER PRODUCTS

VIDEO MONITOR/VIDEO BOARD COMPATIBILITY CHART

	VM-1	VM-2	VM-3	VM-4	VM-5	CM-1	CM-2	CM-4	CM-5	CM-10	CM-11	EGM	VGM
Monochrome Display Adapt. 25-3040			Yes		Yes								
Graphics Tendor 25-3043		Yes	Yes	Yes	Yes		Yes	Yes	Yes	Yes	Yes	Yes	
Graphics Master 25-3044		Yes	Yes	Yes	Yes		Yes	Yes	Yes	Yes	Yes	Yes	
Dual Display Graphics Adapt. 25-3045		Yes	Yes	Yes	Yes		Yes	Yes	Yes	Yes	Yes	Yes	
Dual Display Graphics Adapt. 25-3045A		Yes	Yes	Yes	Yes		Yes	Yes	Yes	Yes	Yes	Yes	
Deluxe Text Display Adapt. 25-3046	Yes					Yes							

(continued on next page)

TANDY COMPUTER PRODUCTS

VIDEO MONITOR/VIDEO BOARD COMPATIBILITY CHART

	VM-1	VM-2	VM-3	VM-4	VM-5	CM-1	CM-2	CM-4	CM-5	CM-10	CM-11	EGM	VGM
Deluxe Text Display Adapt. 25-3046B	Yes					Yes							
Deluxe Text Display Adapt. 25-3046C			Yes		Yes								
Deluxe Graphics Display Adapt. 25-3047	Yes					Yes							
EGA/CGA Adapt. 25-3048			Yes		Yes		Yes	Yes	Yes	Yes	Yes	Yes	
EGA/CGA Adapt. 25-3048A			Yes		Yes		Yes	Yes	Yes	Yes	Yes	Yes	
Monochrome/Parallel Adapt. 25-3049			Yes		Yes								
EGA/CM1 Display Adapter 25-4037	Yes		Yes		Yes	Yes	Yes	Yes	Yes	Yes	Yes	Yes	
VGA Graphics Adapter 25-4043													Yes
8/16 Bit VGA Graphics Adapters													Yes

TANDY COMPUTER PRODUCTSDIAGNOSTIC BEEP CODES

The "DIAG OUTPUT" codes are placed at the diagnostic status port 80h to indicate tests in progress and failed tests on an installed diagnostic display board. The "BEEP CODES" are announced on the speaker if and only if a fatal failure is detected. For instance: "2-1-4" (A burst of two beeps, a single beep, and a burst of 4 beeps) indicates a failure of bit 3 in the first 64K of RAM. Both sets of codes are only used prior to screen initialization and screen retrace verification. Once the screen has been verified, messages are written directly to the Video Memory at 80000 & B8000 hex.

DIAG PORT OUTPUT	BEEP CODES	DESCRIPTION OF TEST OR FAILURE
01h	none	80286 register test in progress or failure
02h	1-1-3	CMOS write/read test in progress or failure
03h	1-1-4	BIOS ROM checksum in progress or failure
04h	1-2-1	Programmable Interval Timer test in progress or failure
05h	1-2-2	DMA initialization in progress or failure
06h	1-2-3	DMA page register write/read test in progress or failure
08h	1-3-1	RAM refresh verification in progress or failure
09h	none	1st 64K RAM test in progress
0Ah	1-3-3	1st 64K RAM segment or data line failure, multi-bit
0Bh	1-3-4	1st 64K RAM odd/even logic failure
0Ch	1-4-1	1st 64K RAM address line failure
0Dh	1-4-2	1st 64K parity failure
10h	2-1-1	1st 64K RAM segment or data line failure, bit 0
11h	2-1-2	1st 64K RAM segment or data line failure, bit 1
12h	2-1-3	1st 64K RAM segment or data line failure, bit 2
13h	2-1-4	1st 64K RAM segment or data line failure, bit 3
14h	2-2-1	1st 64K RAM segment or data line failure, bit 4
15h	2-2-2	1st 64K RAM segment or data line failure, bit 5
16h	2-2-3	1st 64K RAM segment or data line failure, bit 6
17h	2-2-4	1st 64K RAM segment or data line failure, bit 7
18h	2-3-1	1st 64K RAM segment or data line failure, bit 8
19h	2-3-2	1st 64K RAM segment or data line failure, bit 9
1Ah	2-3-3	1st 64K RAM segment or data line failure, bit A
1Bh	2-3-4	1st 64K RAM segment or data line failure, bit B
1Ch	2-4-1	1st 64K RAM segment or data line failure, bit C
1Dh	2-4-2	1st 64K RAM segment or data line failure, bit D
1Eh	2-4-3	1st 64K RAM segment or data line failure, bit E
1Fh	2-4-4	1st 64K RAM segment or data line failure, bit F
20h	3-1-1	slave DMA register test in progress or failure
21h	3-1-2	master DMA register test in progress or failure
22h	3-1-3	master interrupt mask register test in progress or failure
23h	3-1-4	slave interrupt mask register test in progress or failure
25h	none	interrupt vector loading in progress
27h	3-2-4	keyboard controller test in progress or failure
28h	none	CMOS power-fail and checksum checks in progress or failure

(continued on next page)

TANDY COMPUTER PRODUCTS

29h	none	CMOS configuration information validation in progress
2Bh	3-3-4	screen memory test in progress or failure
2Ch	3-4-1	screen initialization in progress or failure
2Dh	3-4-2	screen retrace tests in progress or failure
2Eh	none	search for video ROM in progress
30h	none	screen believed operable
31h	none	monochrome screen believed operable
32h	none	40 column color screen believed operable
33h	none	80 column color screen believed operable

DECIMAL-BINARY-HEXADECIMAL CHART

Dec	Bin	Hex	Dec	Bin	Hex	Dec	Bin	Hex	Dec	Bin	Hex
0	00000000	00	34	01000000	40	128	10000000	80	192	11000000	C0
1	00000001	01	35	01000001	41	129	10000001	81	193	11000001	C1
2	00000010	02	36	01000010	42	130	10000010	82	194	11000010	C2
3	00000011	03	37	01000011	43	131	10000011	83	195	11000011	C3
4	00000100	04	38	01000100	44	132	10000100	84	196	11000100	C4
5	00000101	05	39	01000101	45	133	10000101	85	197	11000101	C5
6	00000110	06	40	01000110	46	134	10000110	86	198	11000110	C6
7	00000111	07	41	01000111	47	135	10000111	87	199	11000111	C7
8	00001000	08	42	01001000	48	136	10001000	88	200	11001000	C8
9	00001001	09	43	01001001	49	137	10001001	89	201	11001001	C9
10	00001010	0A	44	01001010	4A	138	10001010	8A	202	11001010	CA
11	00001011	0B	45	01001011	4B	139	10001011	8B	203	11001011	CB
12	00001100	0C	46	01001100	4C	140	10001100	8C	204	11001100	CC
13	00001101	0D	47	01001101	4D	141	10001101	8D	205	11001101	CD
14	00001110	0E	48	01001110	4E	142	10001110	8E	206	11001110	CE
15	00001111	0F	49	01001111	4F	143	10001111	8F	207	11001111	CF
16	00010000	10	50	01010000	50	144	10010000	90	208	11010000	D0
17	00010001	11	51	01010001	51	145	10010001	91	209	11010001	D1
18	00010010	12	52	01010010	52	146	10010010	92	210	11010010	D2
19	00010011	13	53	01010011	53	147	10010011	93	211	11010011	D3
20	00010100	14	54	01010100	54	148	10010100	94	212	11010100	D4
21	00010101	15	55	01010101	55	149	10010101	95	213	11010101	D5
22	00010110	16	56	01010110	56	150	10010110	96	214	11010110	D6
23	00010111	17	57	01010111	57	151	10010111	97	215	11010111	D7
24	00011000	18	58	01011000	58	152	10011000	98	216	11011000	D8
25	00011001	19	59	01011001	59	153	10011001	99	217	11011001	D9
26	00011010	1A	60	01011010	5A	154	10011010	9A	218	11011010	DA
27	00011011	1B	61	01011011	5B	155	10011011	9B	219	11011011	DB
28	00011100	1C	62	01011100	5C	156	10011100	9C	220	11011100	DC
29	00011101	1D	63	01011101	5D	157	10011101	9D	221	11011101	DD
30	00011110	1E	64	01011110	5E	158	10011110	9E	222	11011110	DE
31	00011111	1F	65	01011111	5F	159	10011111	9F	223	11011111	DF
32	00100000	20	66	01100000	60	160	10100000	A0	224	11100000	E0
33	00100001	21	67	01100001	61	161	10100001	A1	225	11100001	E1
34	00100010	22	68	01100010	62	162	10100010	A2	226	11100010	E2
35	00100011	23	69	01100011	63	163	10100011	A3	227	11100011	E3
36	00100100	24	70	01100100	64	164	10100100	A4	228	11100100	E4
37	00100101	25	71	01100101	65	165	10100101	A5	229	11100101	E5
38	00100110	26	72	01100110	66	166	10100110	A6	230	11100110	E6
39	00100111	27	73	01100111	67	167	10100111	A7	231	11100111	E7
40	00101000	28	74	01101000	68	168	10101000	A8	232	11101000	E8
41	00101001	29	75	01101001	69	169	10101001	A9	233	11101001	E9
42	00101010	2A	76	01101010	6A	170	10101010	AA	234	11101010	EA
43	00101011	2B	77	01101011	6B	171	10101011	AB	235	11101011	EB
44	00101100	2C	78	01101100	6C	172	10101100	AC	236	11101100	EC
45	00101101	2D	79	01101101	6D	173	10101101	AD	237	11101101	ED
46	00101110	2E	80	01101110	6E	174	10101110	AE	238	11101110	EE
47	00101111	2F	81	01101111	6F	175	10101111	AF	239	11101111	EF
48	00110000	30	82	01110000	70	176	10110000	B0	240	11110000	FF
49	00110001	31	83	01110001	71	177	10110001	B1	241	11110001	F1
50	00110010	32	84	01110010	72	178	10110010	B2	242	11110010	F2
51	00110011	33	85	01110011	73	179	10110011	B3	243	11110011	F3
52	00110100	34	86	01110100	74	180	10110100	B4	244	11110100	F4
53	00110101	35	87	01110101	75	181	10110101	B5	245	11110101	F5
54	00110110	36	88	01110110	76	182	10110110	B6	246	11110110	F6
55	00110111	37	89	01110111	77	183	10110111	B7	247	11110111	F7
56	00111000	38	90	01111000	78	184	10111000	B8	248	11111000	F8
57	00111001	39	91	01111001	79	185	10111001	B9	249	11111001	F9
58	00111010	3A	92	01111010	7A	186	10111010	BA	250	11111010	FA
59	00111011	3B	93	01111011	7B	187	10111011	BB	251	11111011	FB
60	00111100	3C	94	01111100	7C	188	10111100	BC	252	11111100	FC
61	00111101	3D	95	01111101	7D	189	10111101	BD	253	11111101	FD
62	00111110	3E	96	01111110	7E	190	10111110	BE	254	11111110	FE
63	00111111	3F	97	01111111	7F	191	10111111	BF	255	11111111	FF

TANDY COMPUTER PRODUCTSASCII CHARACTER CODE CHART

<u>CODE</u>		<u>CHARACTER</u>	<u>CODE</u>		<u>CHARACTER</u>	<u>CODE</u>		<u>CHARACTER</u>
<u>Dec</u>	<u>Hex</u>		<u>Dec</u>	<u>Hex</u>		<u>Dec</u>	<u>Hex</u>	
32	20	Space	64	40	@	96	60	`
33	21	!	65	41	A	97	61	a
34	22	"	66	42	B	98	62	b
35	23	#	67	43	C	99	63	c
36	24	\$	68	44	D	100	64	d
37	25	%	69	45	E	101	65	e
38	26	&	70	46	F	102	66	f
39	27	'	71	47	G	103	67	g
40	28	(72	48	H	104	68	h
41	29)	73	49	I	105	69	i
42	2A	*	74	4A	J	106	6A	j
43	2B	+	75	4B	K	107	6B	k
44	2C	,	76	4C	L	108	6C	l
45	2D	-	77	4D	M	109	6D	m
46	2E	.	78	4E	N	110	6E	n
47	2F	/	79	4F	O	111	6F	o
48	30	0	80	50	P	112	70	p
49	31	1	81	51	Q	113	71	q
50	32	2	82	52	R	114	72	r
51	33	3	83	53	S	115	73	s
52	34	4	84	54	T	116	74	t
53	35	5	85	55	U	117	75	u
54	36	6	86	56	V	118	76	v
55	37	7	87	57	W	119	77	w
56	38	8	88	58	X	120	78	x
57	39	9	89	59	Y	121	79	y
58	3A	:	90	5A	Z	122	7A	z
59	3B	;	91	5B	[123	7B	{
60	3C	<	92	5C	\	124	7C	
61	3D	=	93	5D]	125	7D	}
62	3E	>	94	5E	^	126	7E	~
63	3F	?	95	5F	_	127	7F	+

Codes 0-31₁₀ are used as control codes, and are not part of the ASCII character set.

Codes 128-255₁₀ are defined by each operating system, and are not part of the ASCII character set. They may represent graphics characters, space compression codes or special control codes that can be imbedded in programs, etc.

NOTE: ASCII stands for American Standard Code for Information Interchange

VGA PORT CONNECTOR PINOUT

The following table indicates the pin functions of the video connector.

Pin Function

- 1 Red Video
- 2 Green Video
- 3 Blue Video
- 4 Monitor ID Bit 2 (not used)
- 5 Ground
- 6 Red Return (ground)
- 7 Green Return (ground)
- 8 Blue Return (ground)
- 9 Key (no pin)
- 10 Sync Return (ground)
- 11 Monitor ID Bit 0 (not used)
- 12 Monitor ID Bit 1 (ground)
- 13 Horizontal Sync
- 14 Vertical Sync
- 15 Not Used

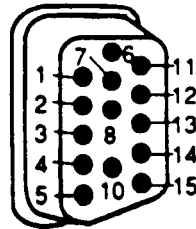

Monochrome-type monitors use Green Video for all video input and ignore Red Video and Blue Video.

Monitor ID Bits are not used. The monitor type is determined when your system is turned on.

PERIPHERAL INTERFACES PINOUTS

Parallel I/O printer port (25 pin connector)

(* denotes "Active Low signals")

- 1 - Strobe*
- 2 - Data Bit 0
- 3 - Data Bit 1
- 4 - Data Bit 2
- 5 - Data Bit 3
- 6 - Data Bit 4
- 7 - Data Bit 5
- 8 - Data Bit 6
- 9 - Data Bit 7
- 10 - Acknowledge*
- 11 - Busy
- 12 - Paper End
- 13 - Select
- 14 - Auto Feed*
- 15 - Error*
- 16 - Initialize*
- 17 - Select In*
- 18-25 - Ground

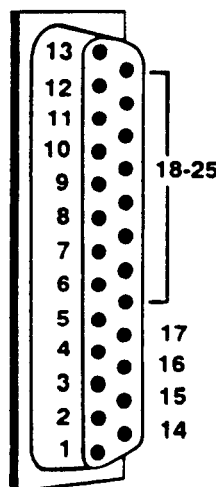

RS-232C serial port

Pin Assignments:

- 1 - Carrier Detect
- 2 - Receive Data
- 3 - Transmit Data
- 4 - Data Terminal Ready
- 5 - Signal Ground
- 6 - Data Set Ready
- 7 - Request To Send
- 8 - Clear To Send
- 9 - Ring Indicator

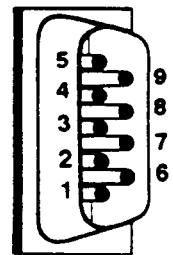

This page intentionally left blank.

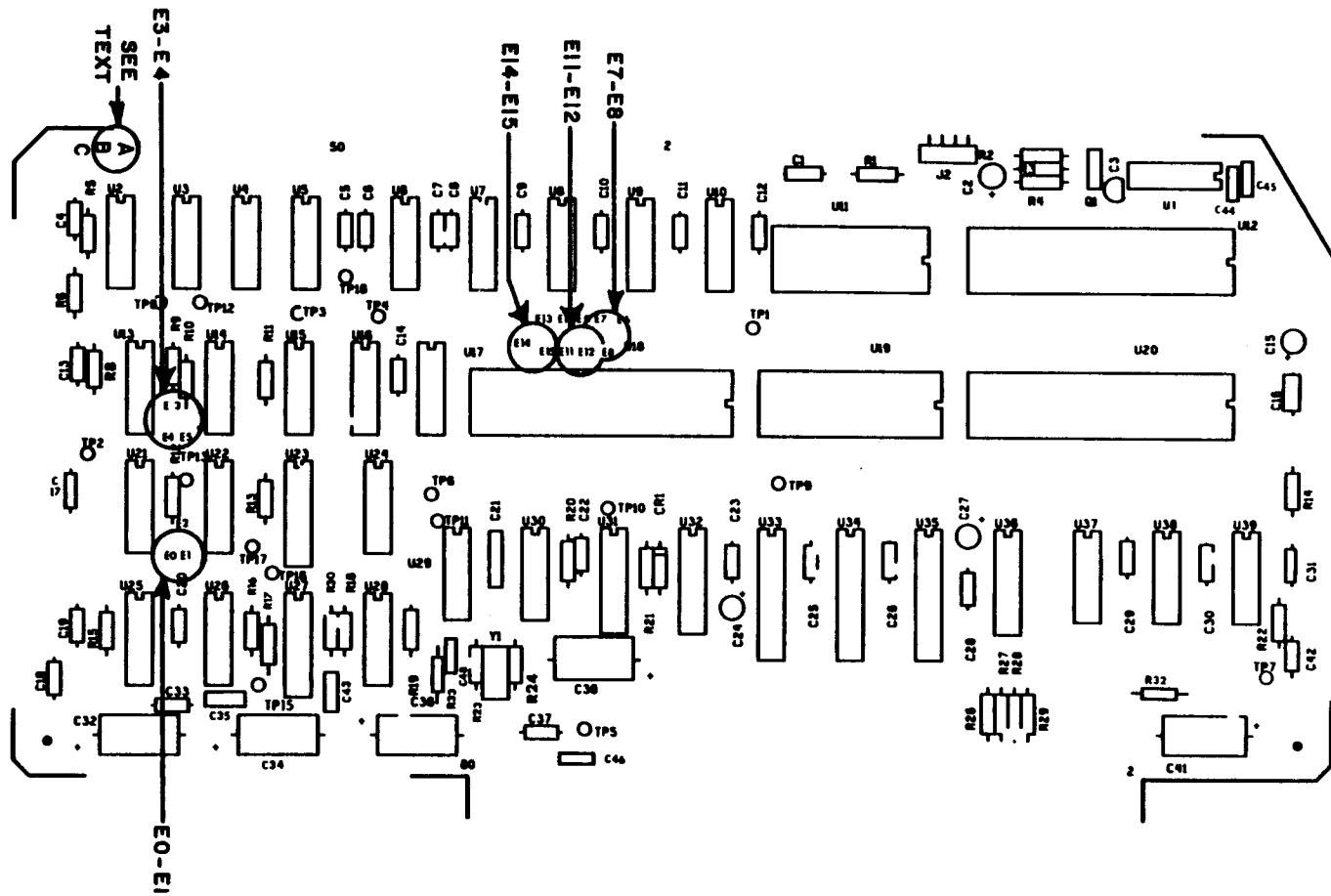

Figure 1. Z80 CPU Board (Rev. A through C).

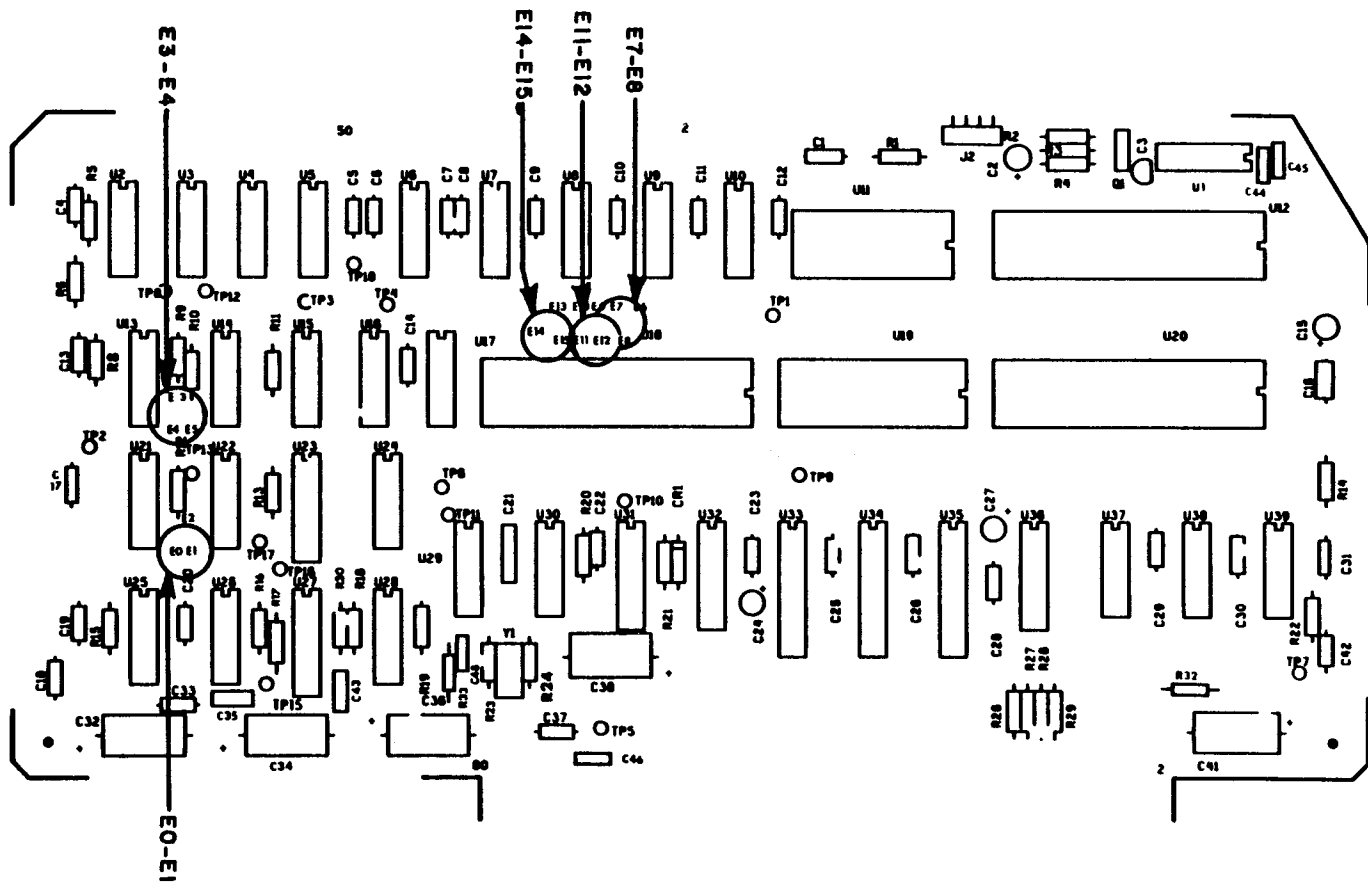

Figure 2. Z80 CPU Board (Rev. D).

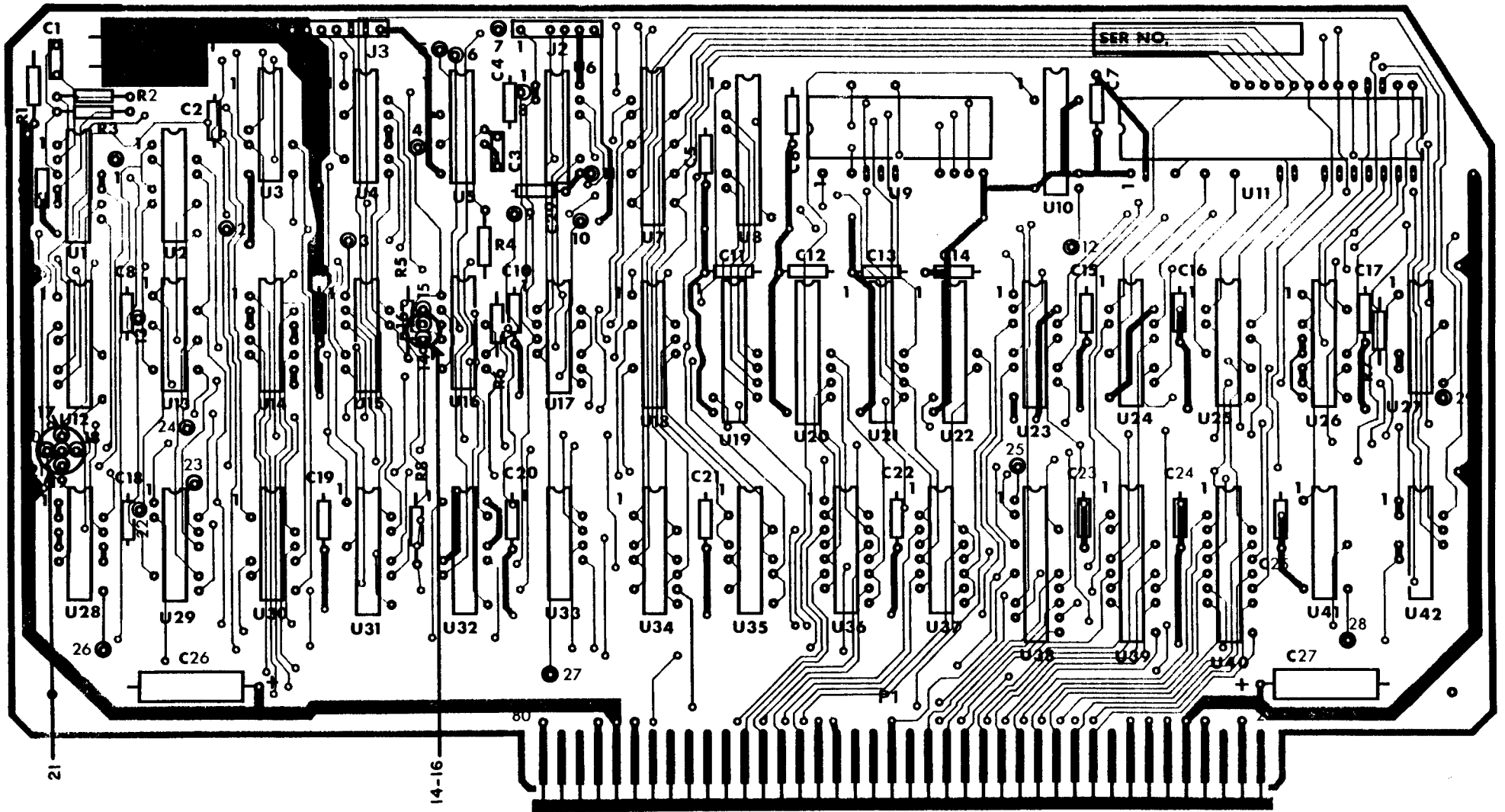

Figure 3. Keyboard/Video Board (Early Style).

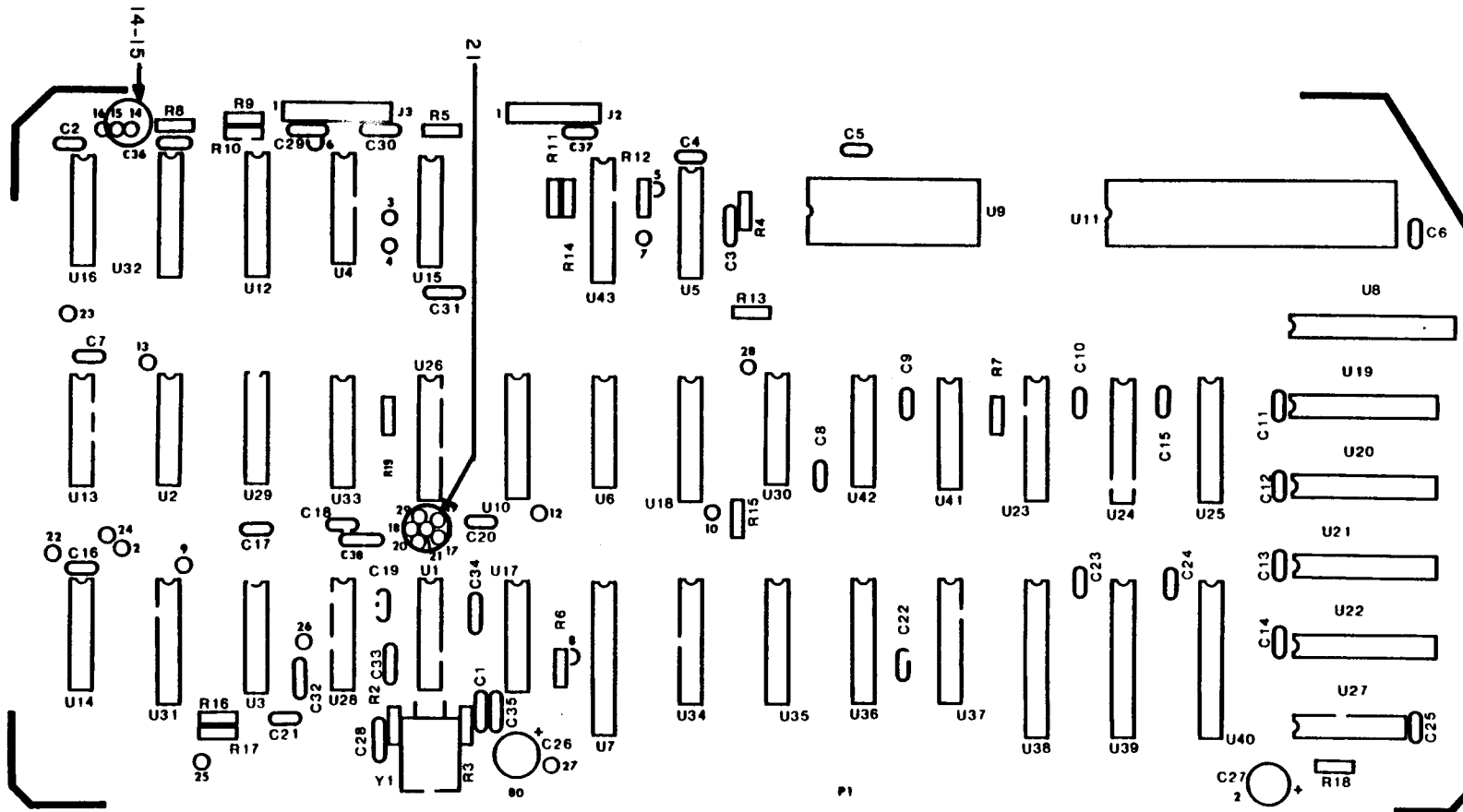

Figure 4. Keyboard/Video Board (Late Style Labeled LEIMV-1 1082).

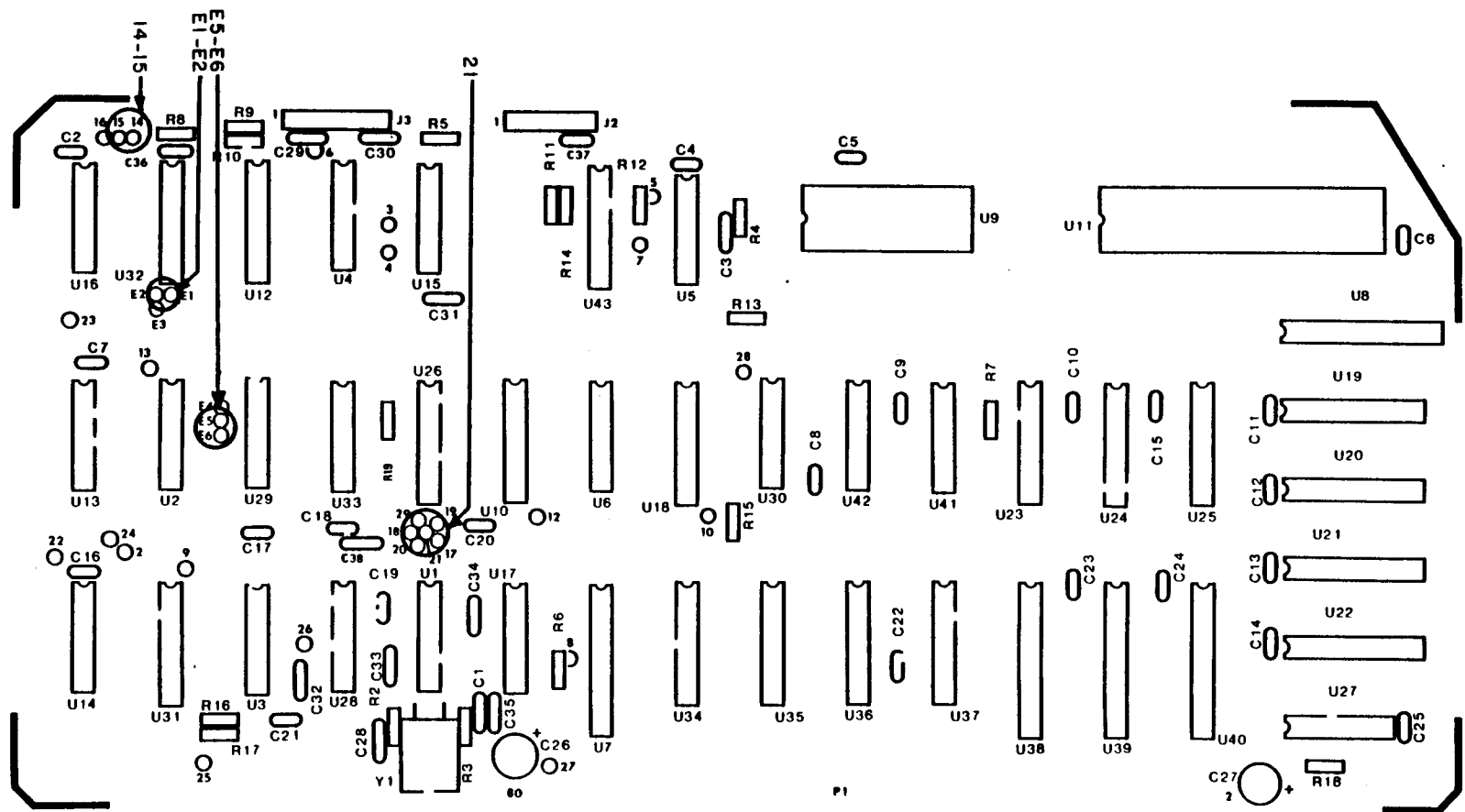

Figure 5. Keyboard/Video Board (Model 12/16B).

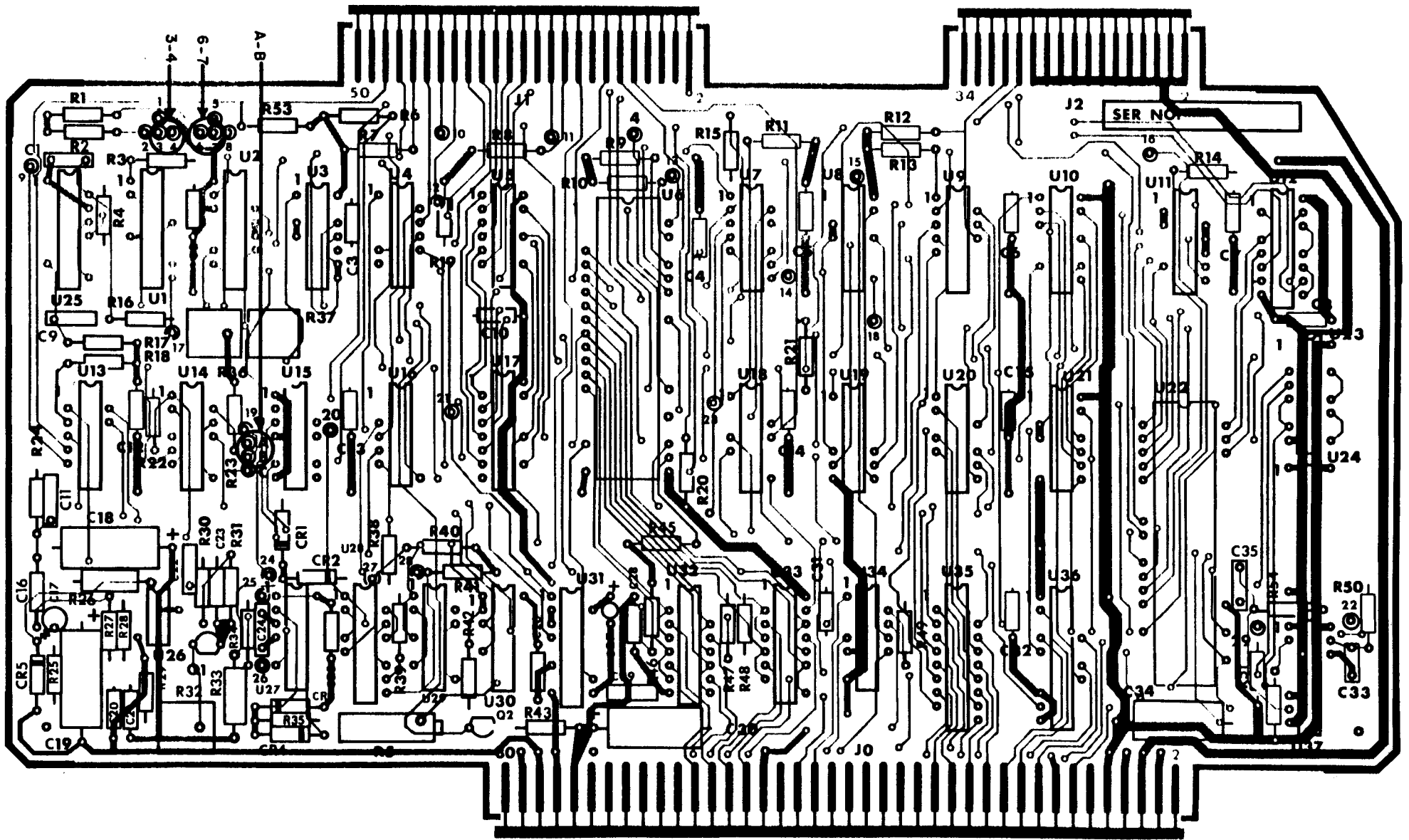

Figure 6. FDC Board (Early Style).

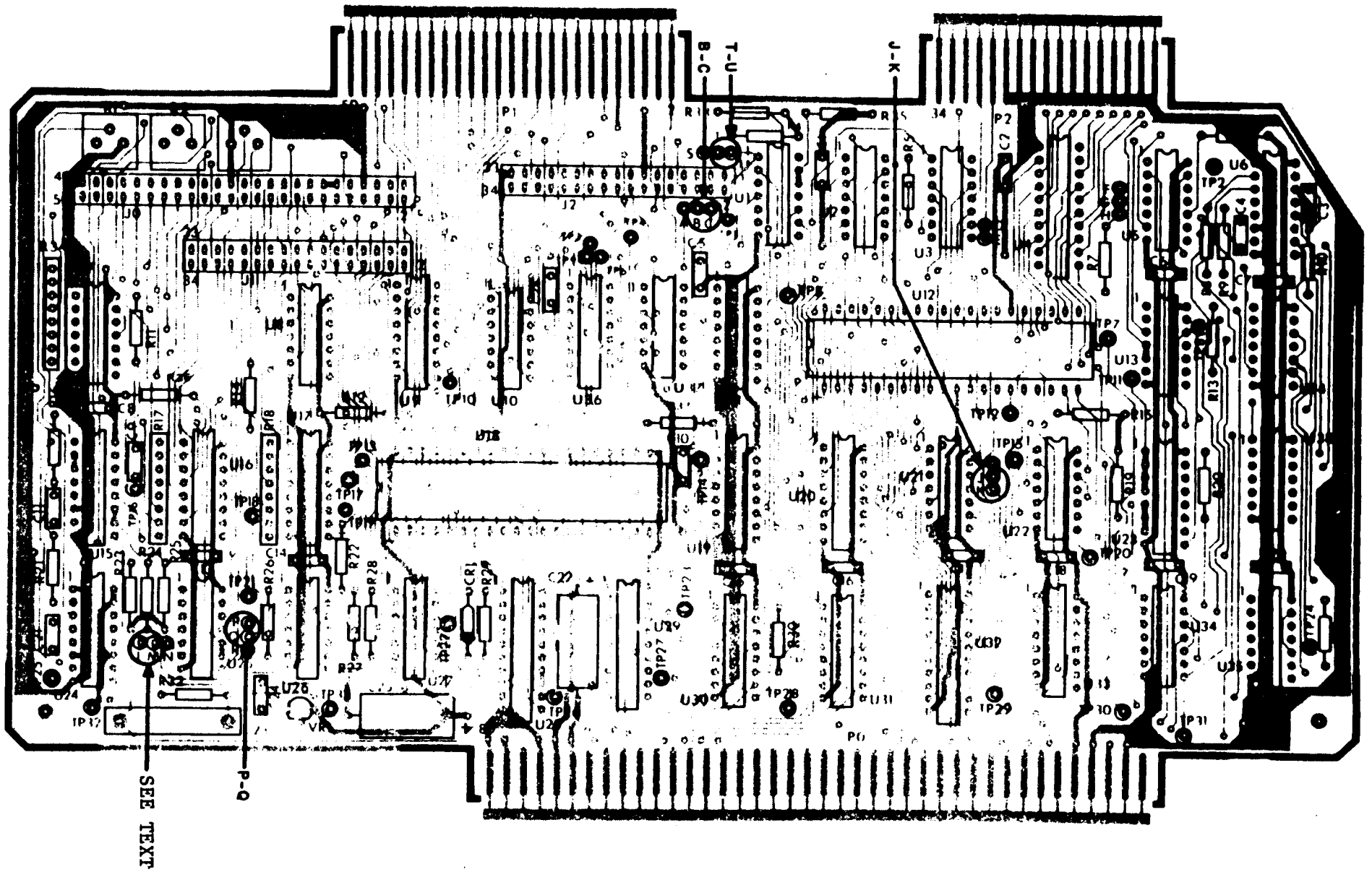

Figure 7. FDC Board (Late Style for Model II).

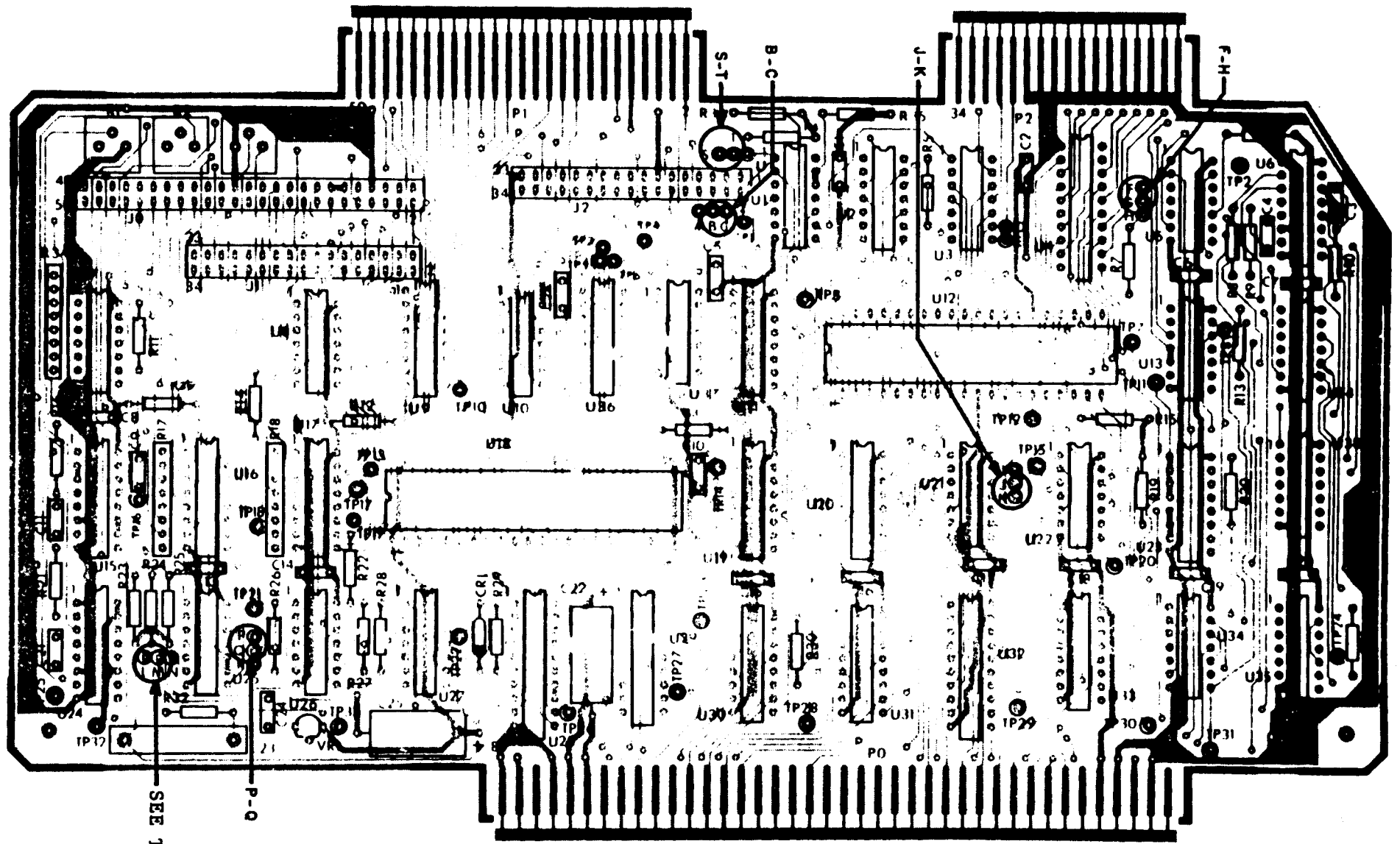

Figure 8. FDC Board (Late Style for Model 16).

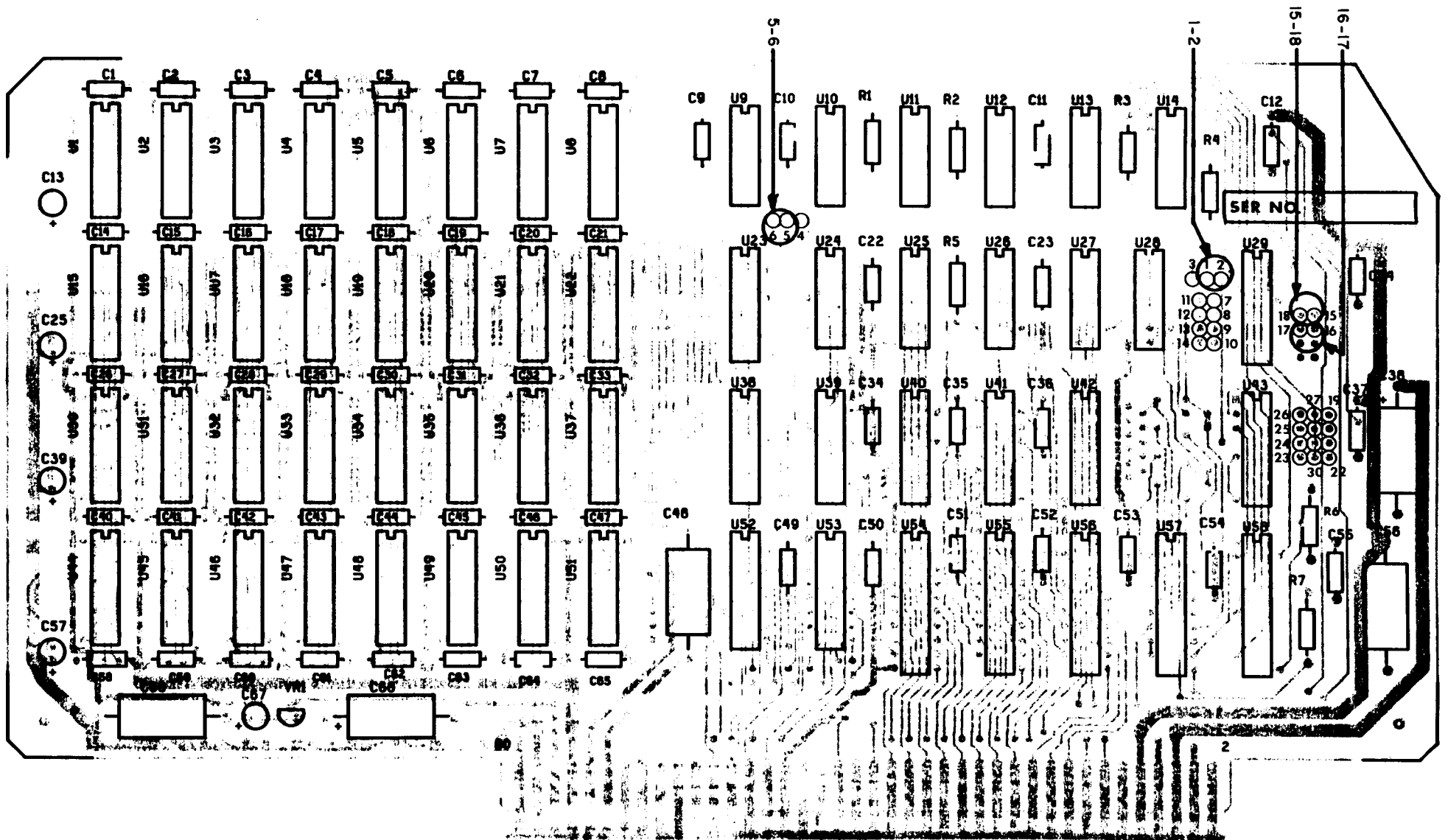

Figure 9. First 32K Memory Board.

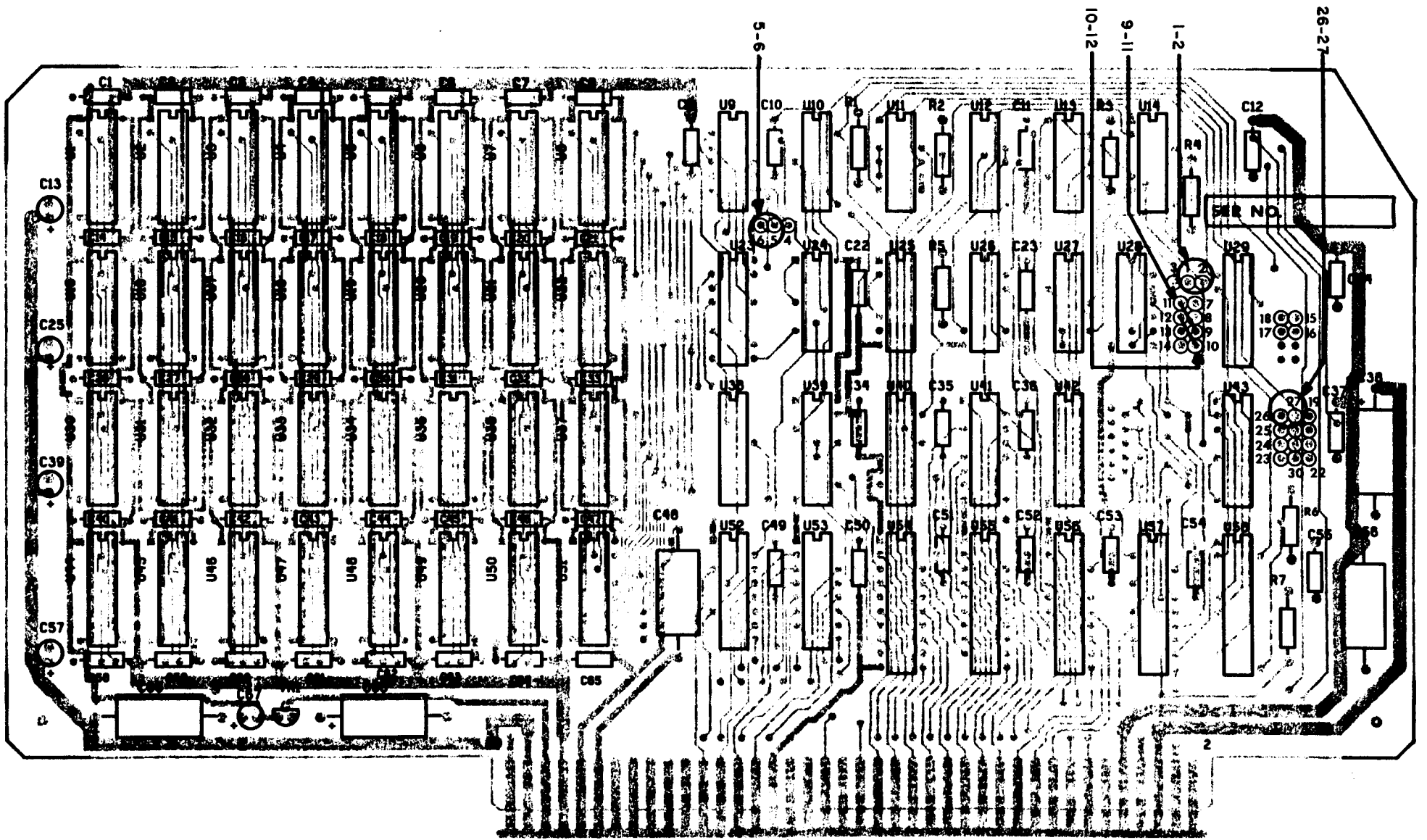

Figure 10. Second 32K Memory Board.

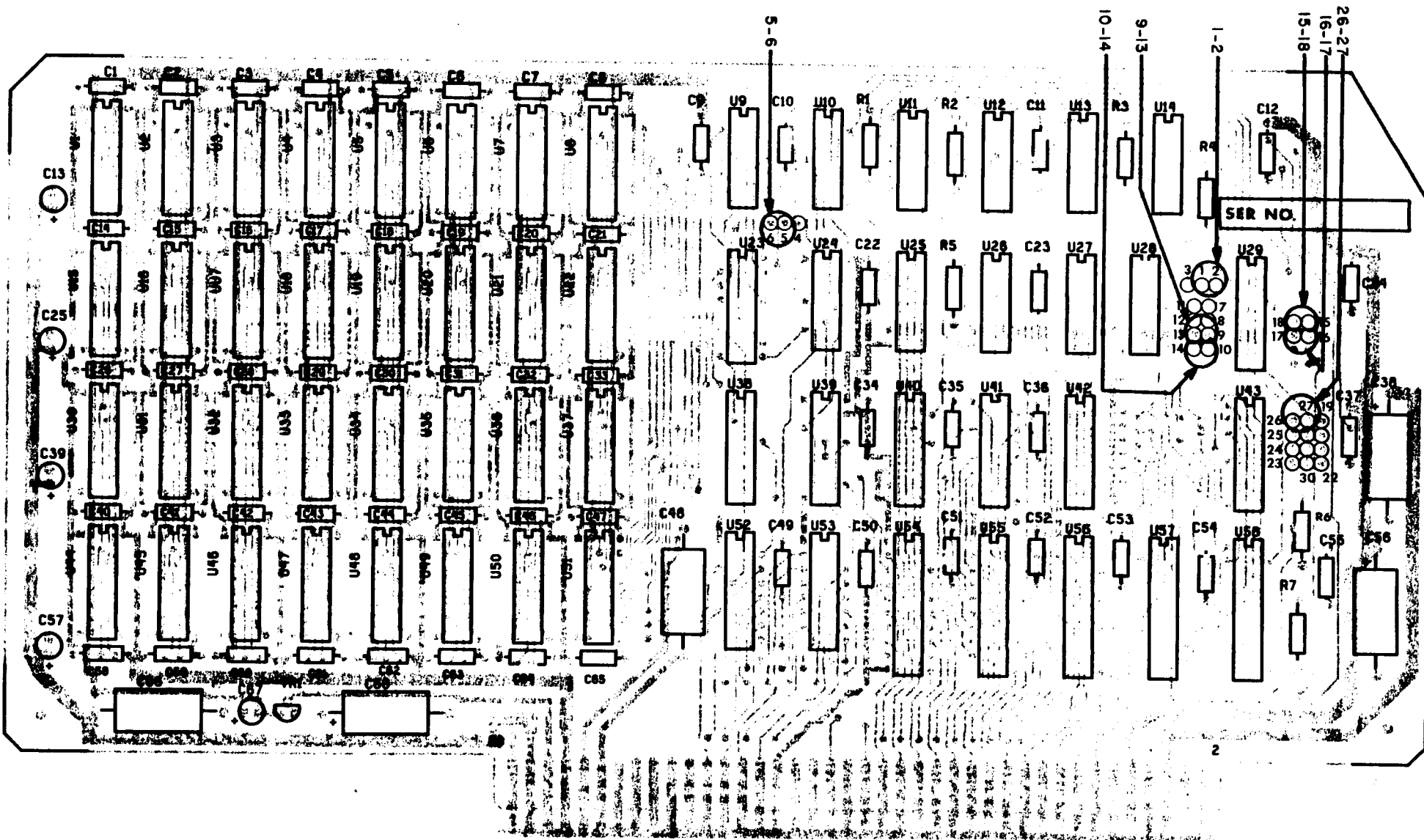

Figure 11. First 64K Memory Board.

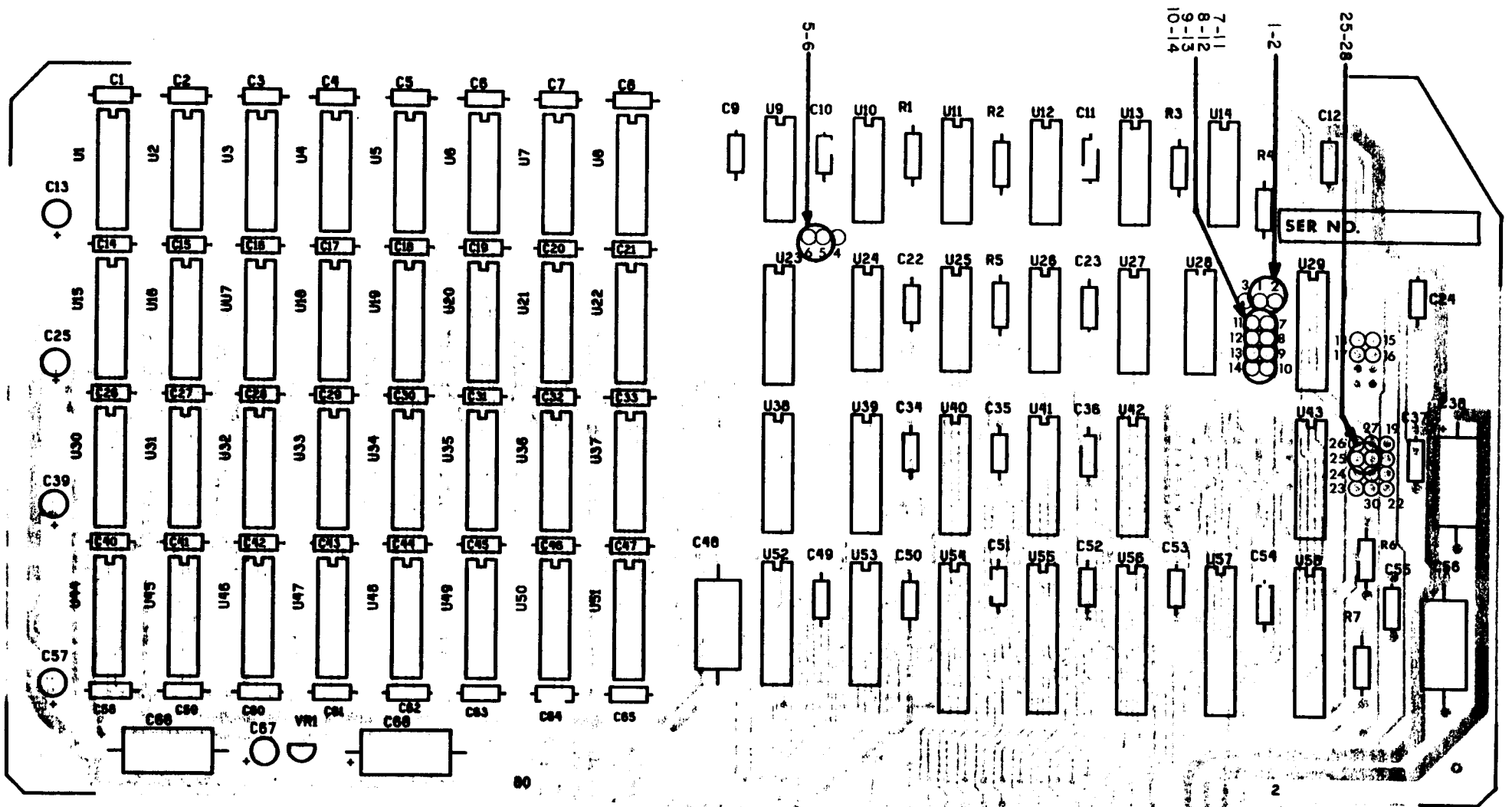

Figure 12. Visicalc 64K Memory Board.

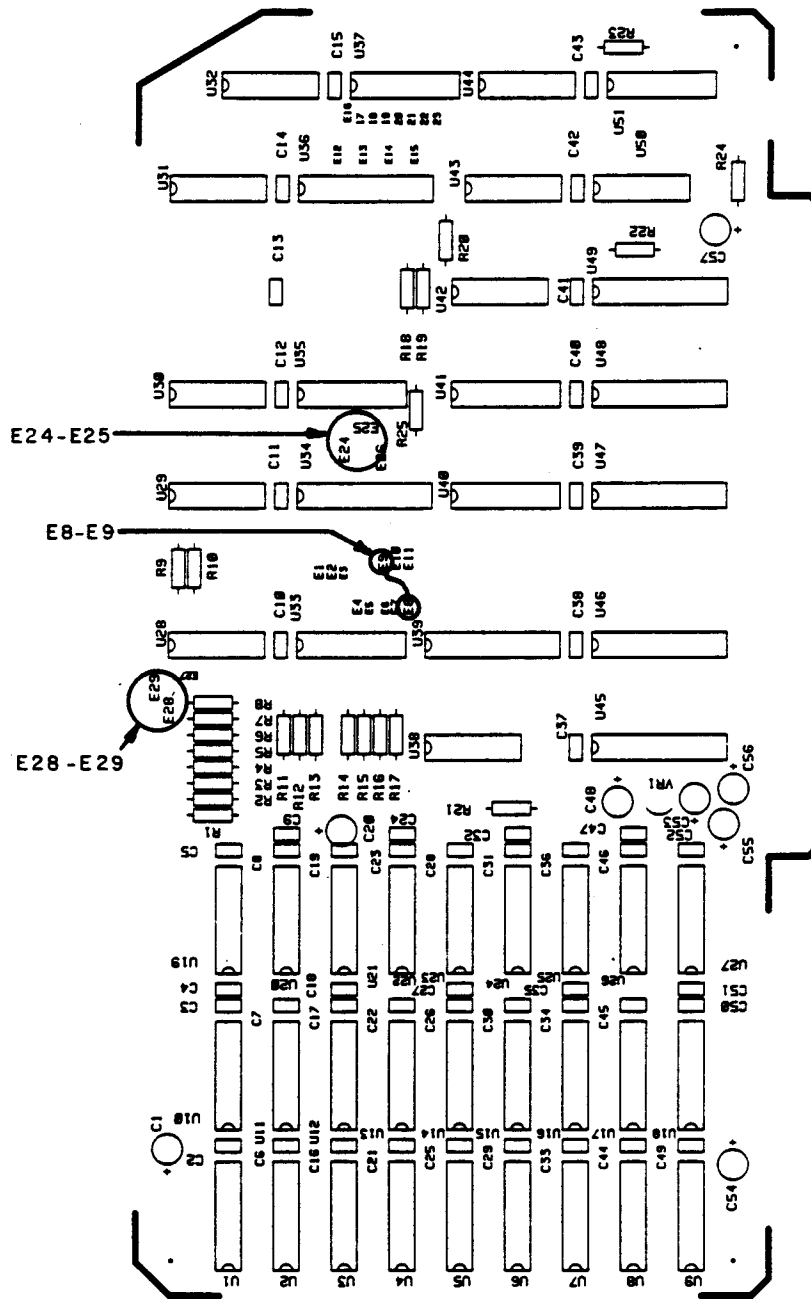

Figure 13. 144K Board Jumpered for Arcnet.

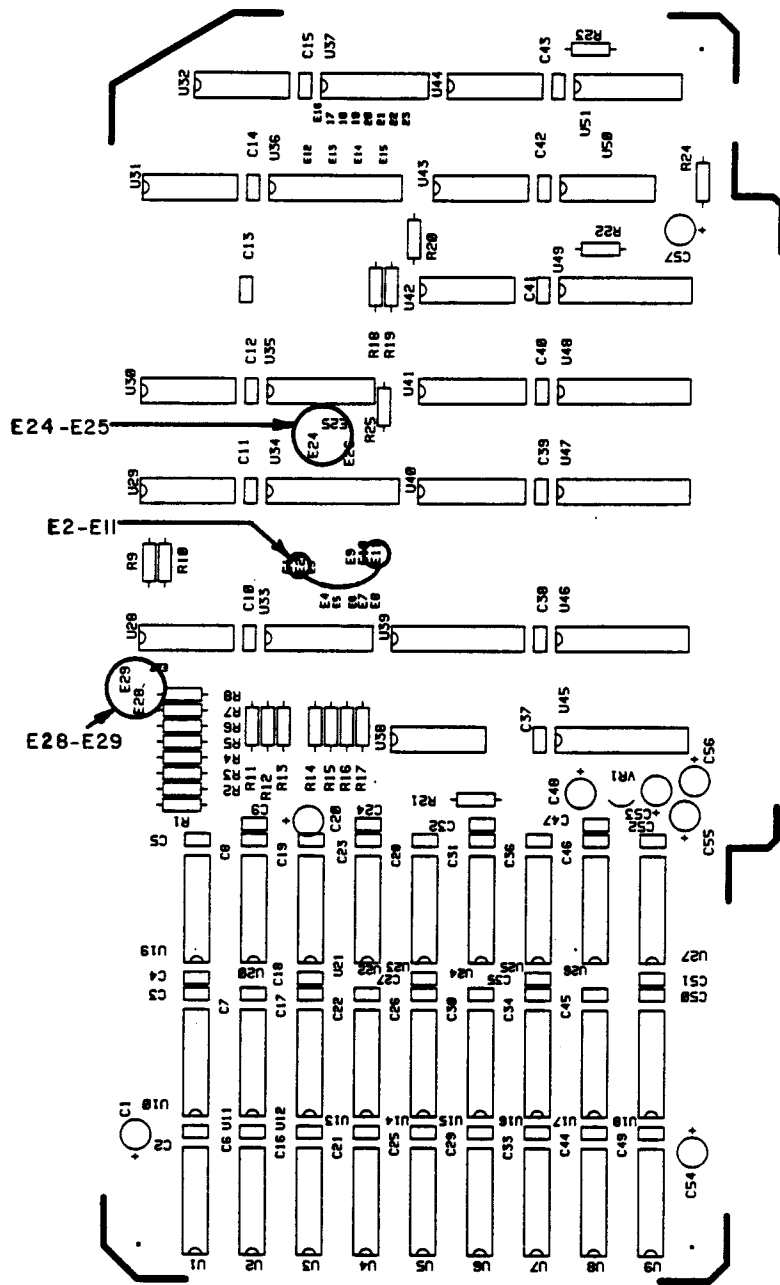

Figure 14. 144K Board Jumpered for Visicalc.

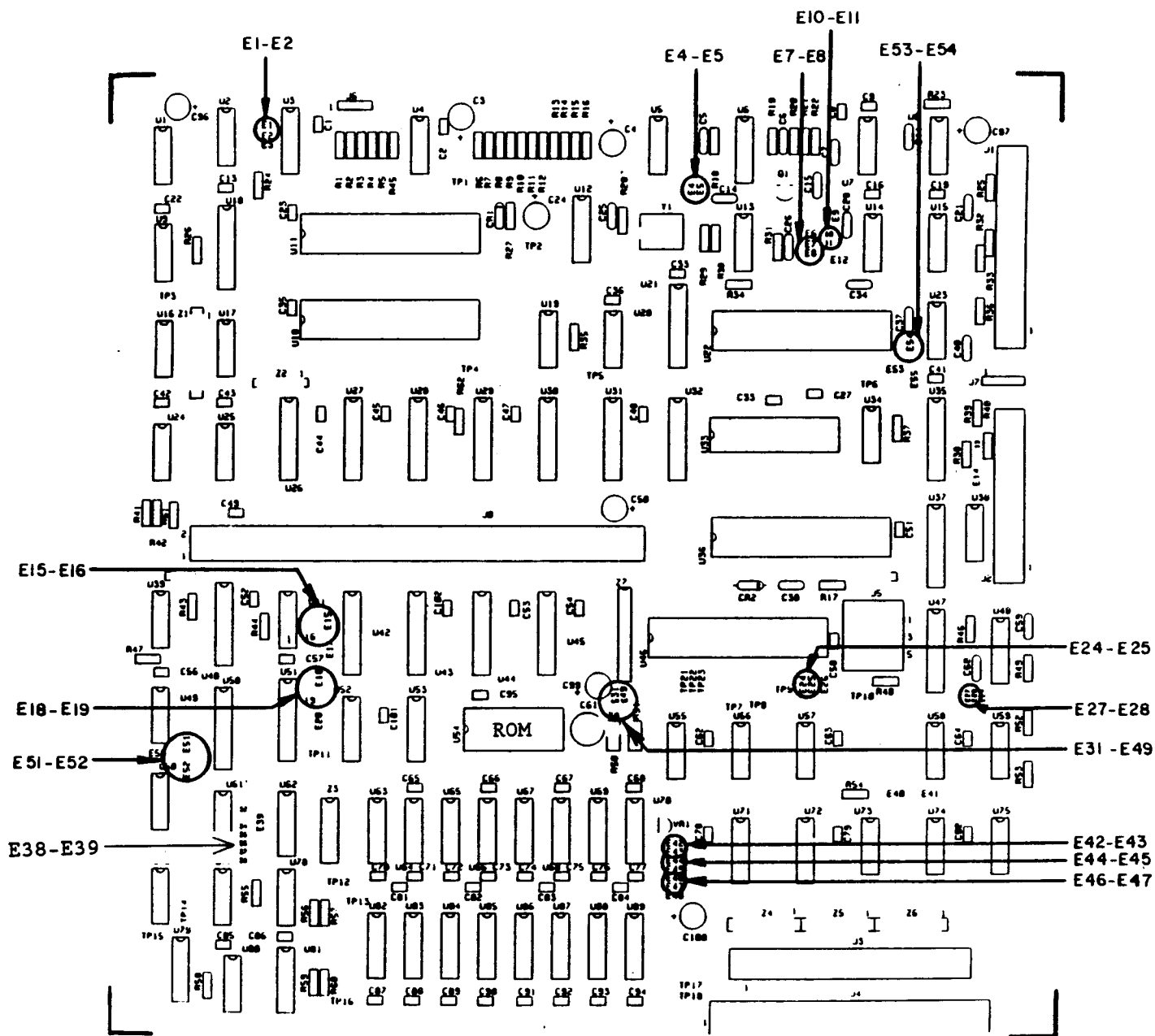

Figure 15. Model 12 Main Logic Board.

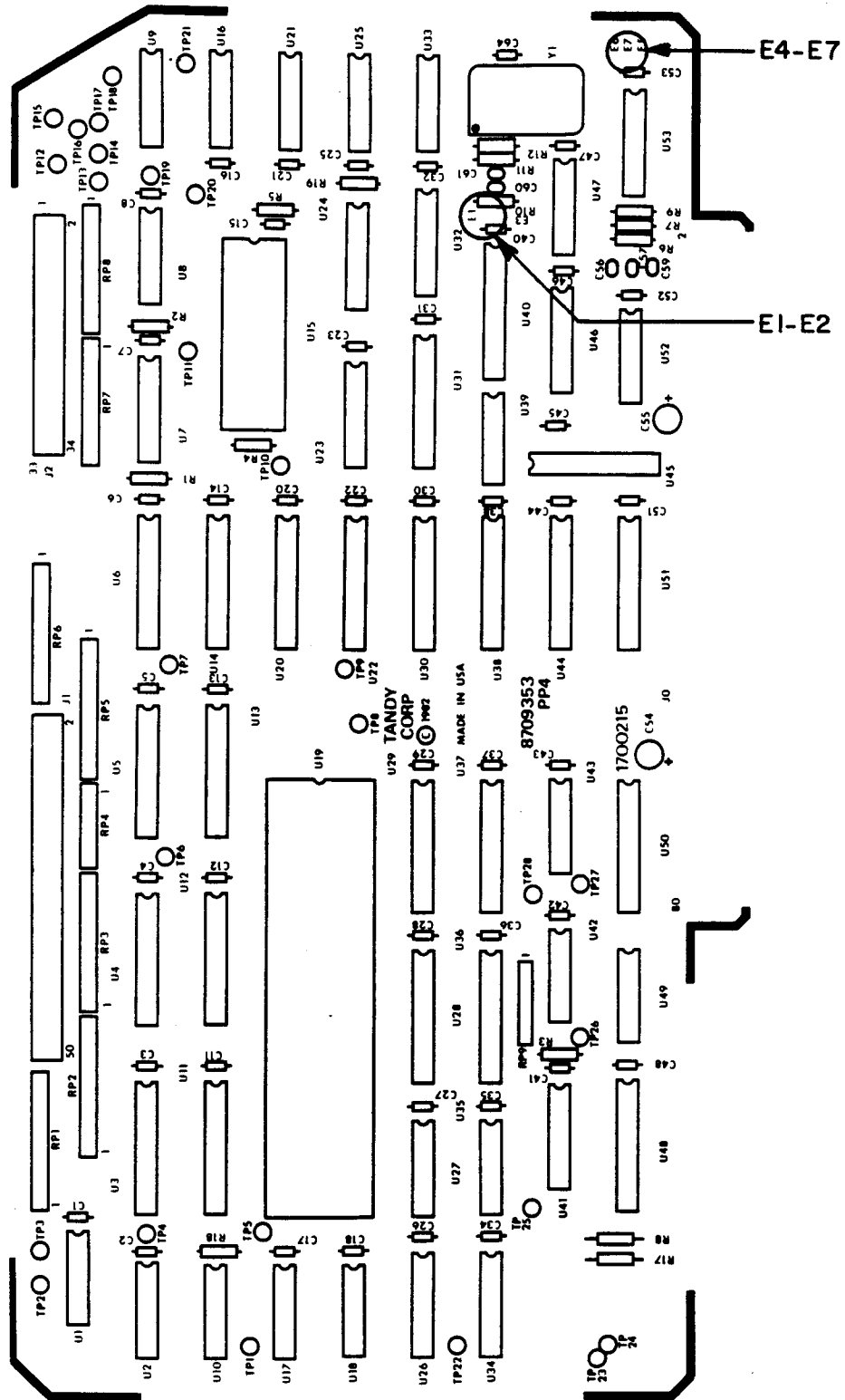

Figure 17. Reduced Size 68000 CPU Board.

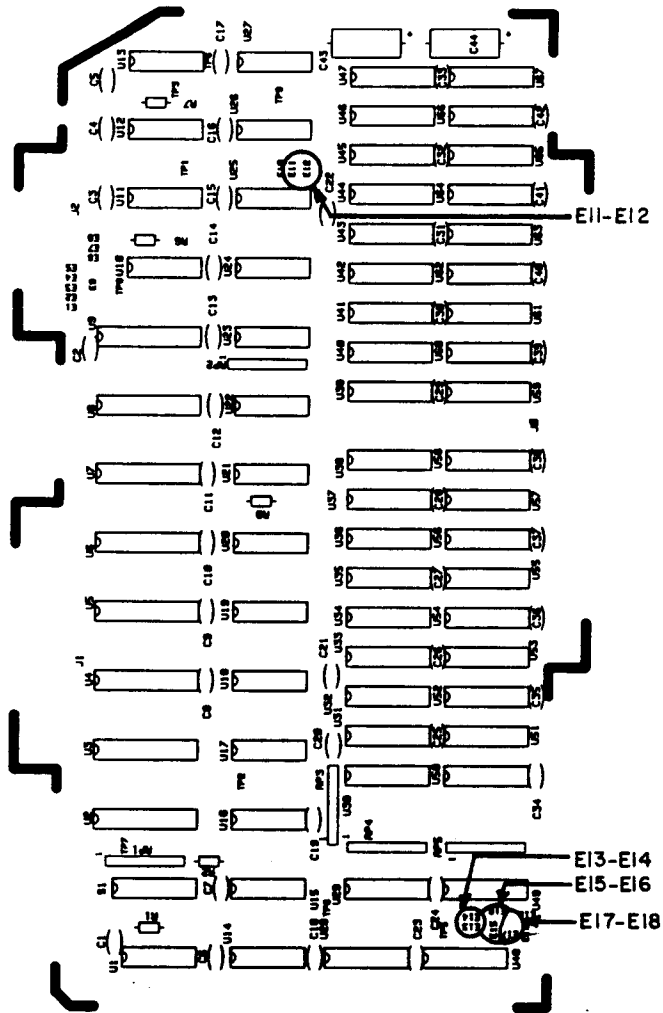

Figure 18. 68000 Memory Board.

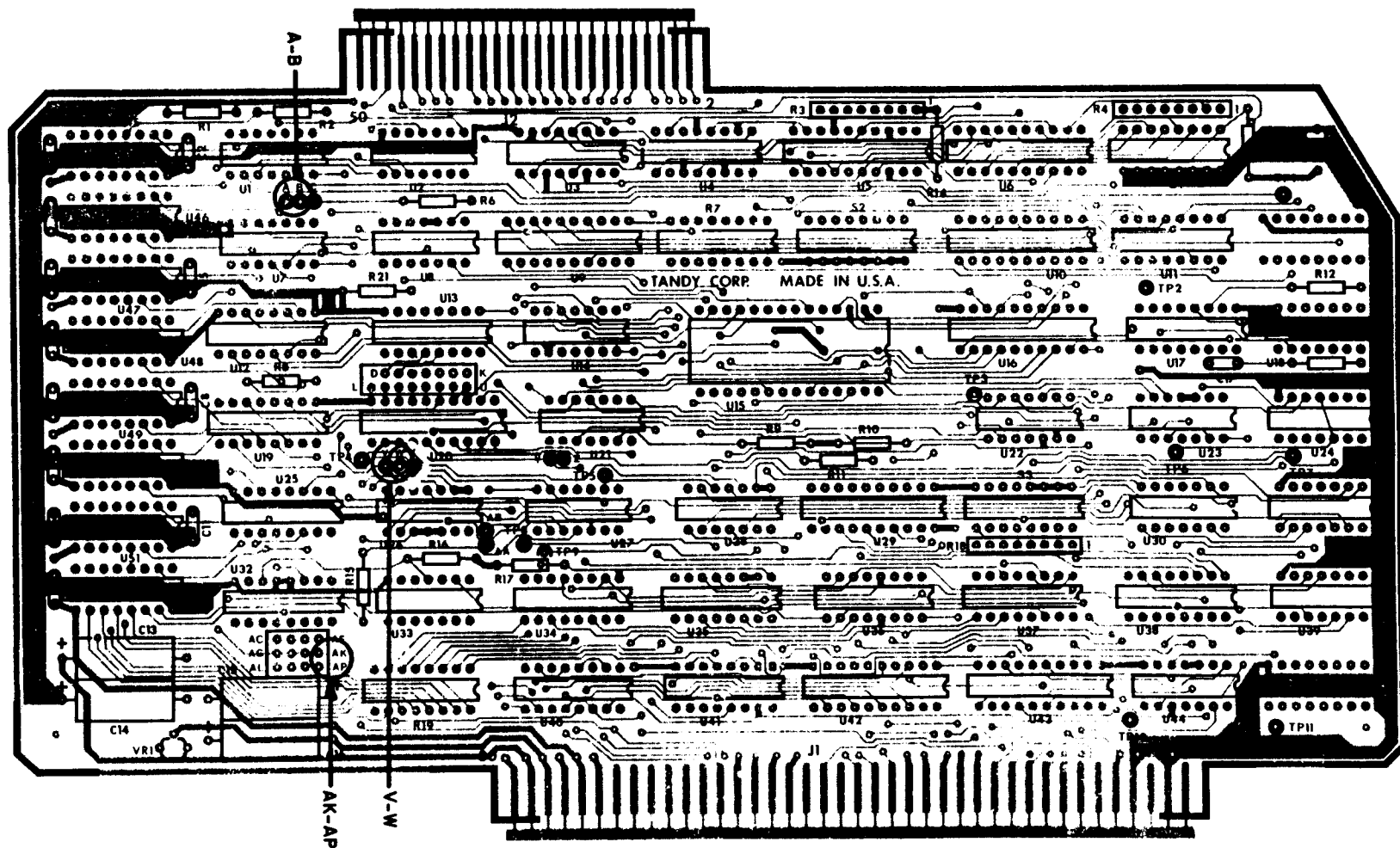

Figure 19. 8 MEG Hard Disk Interface In Model II/16/16B.

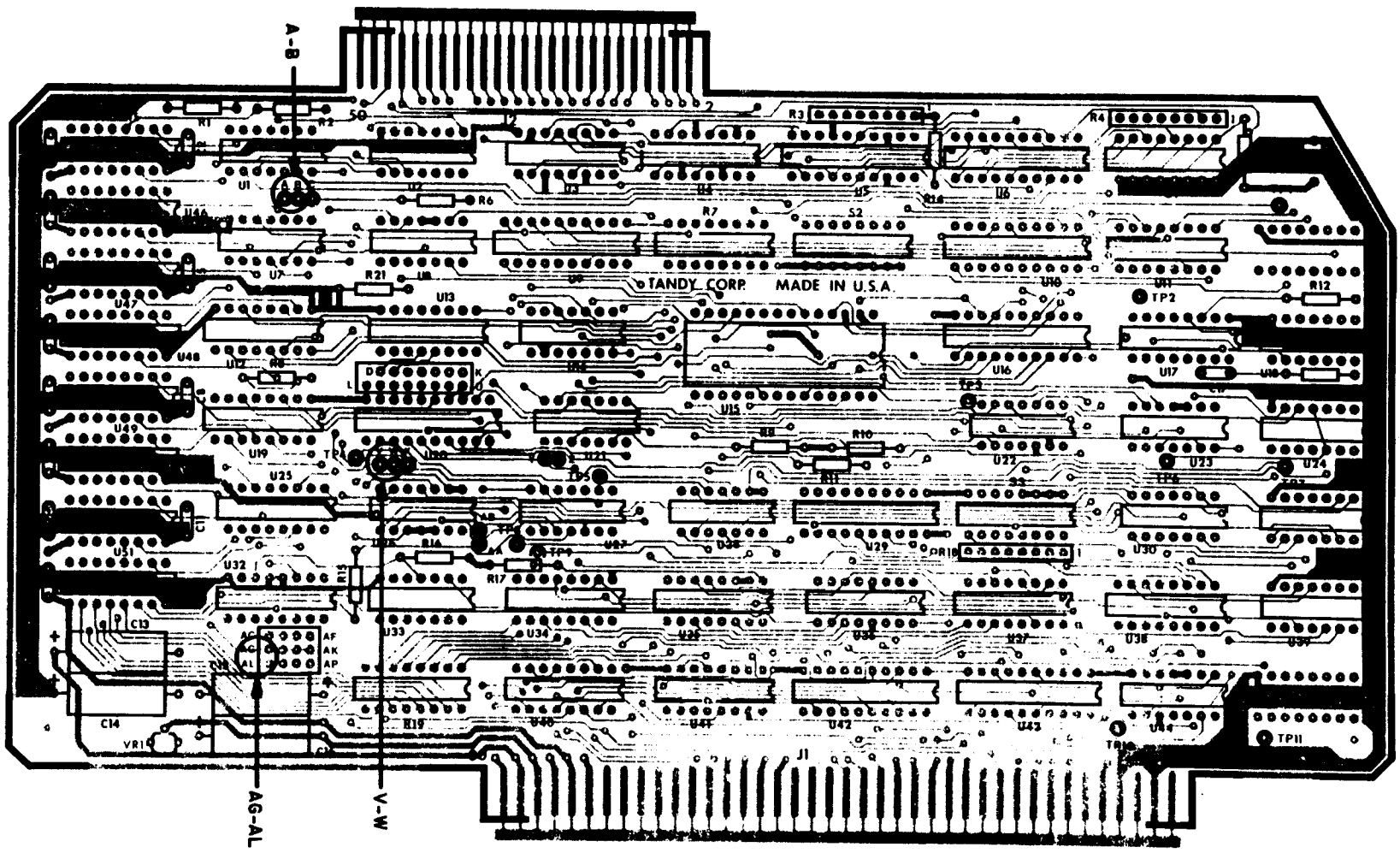

Figure 20. 8 MEG Hard Disk Interface In Model 12.

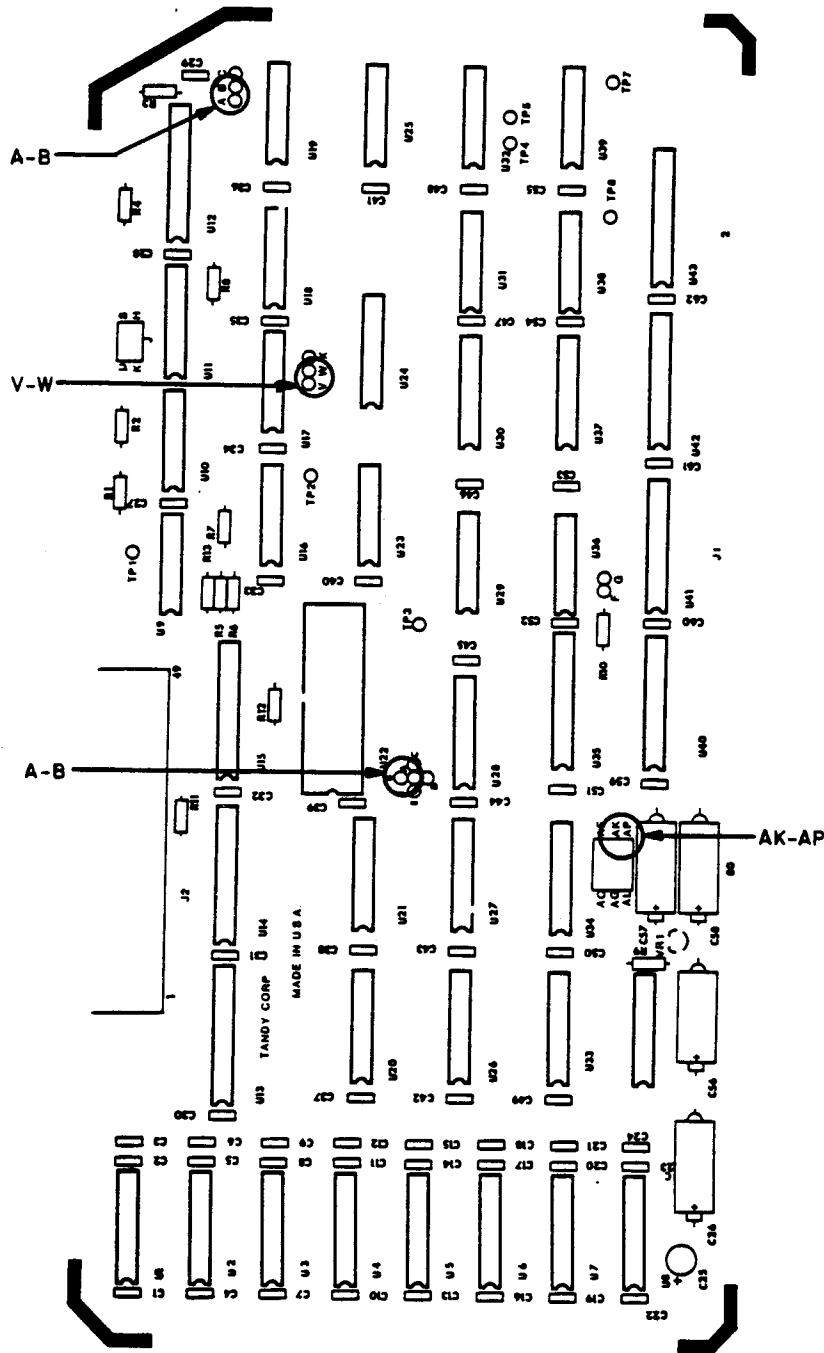

Figure 21. 12 MEG Hard Disk Interface In Model II/16/16B.

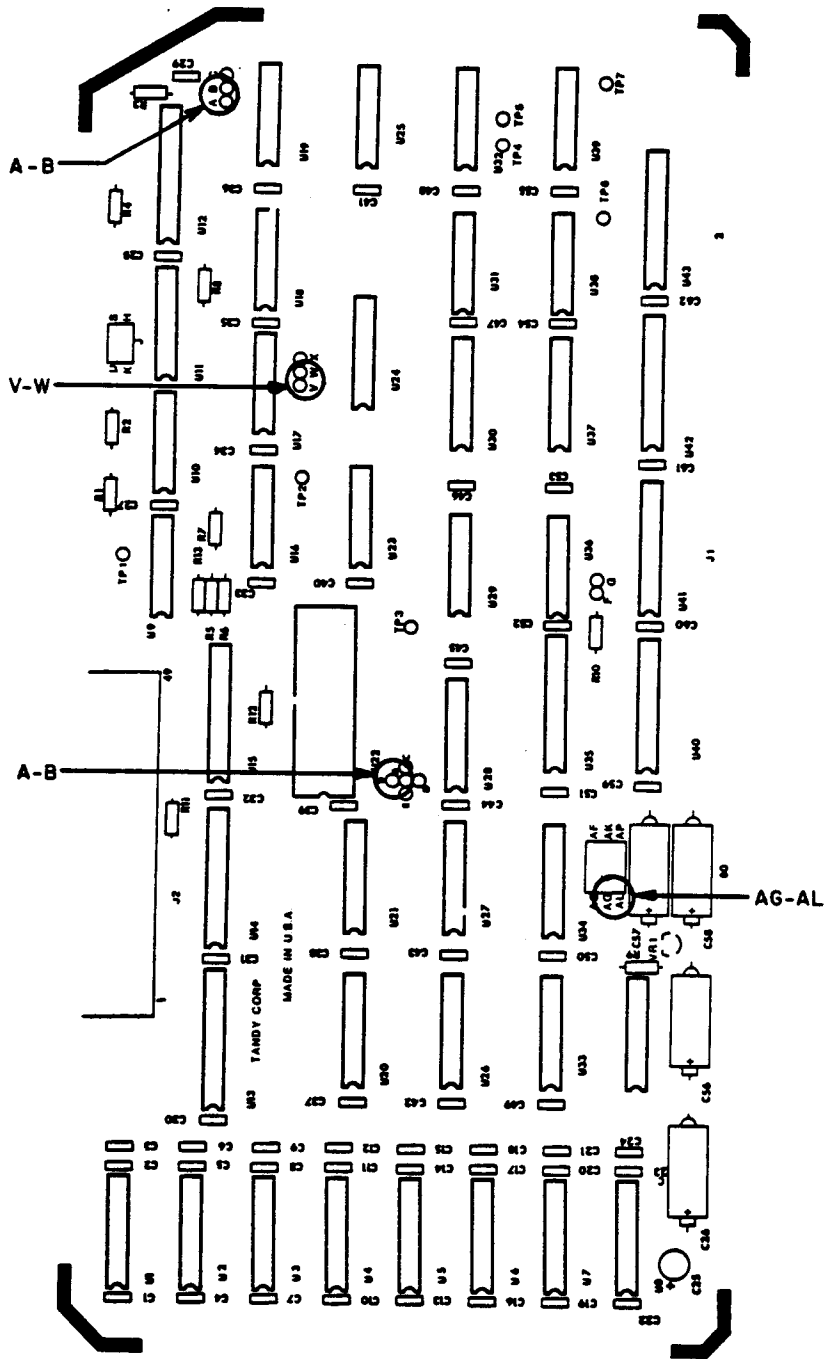

Figure 22. 12 MEG Hard Disk Interface In Model 12.

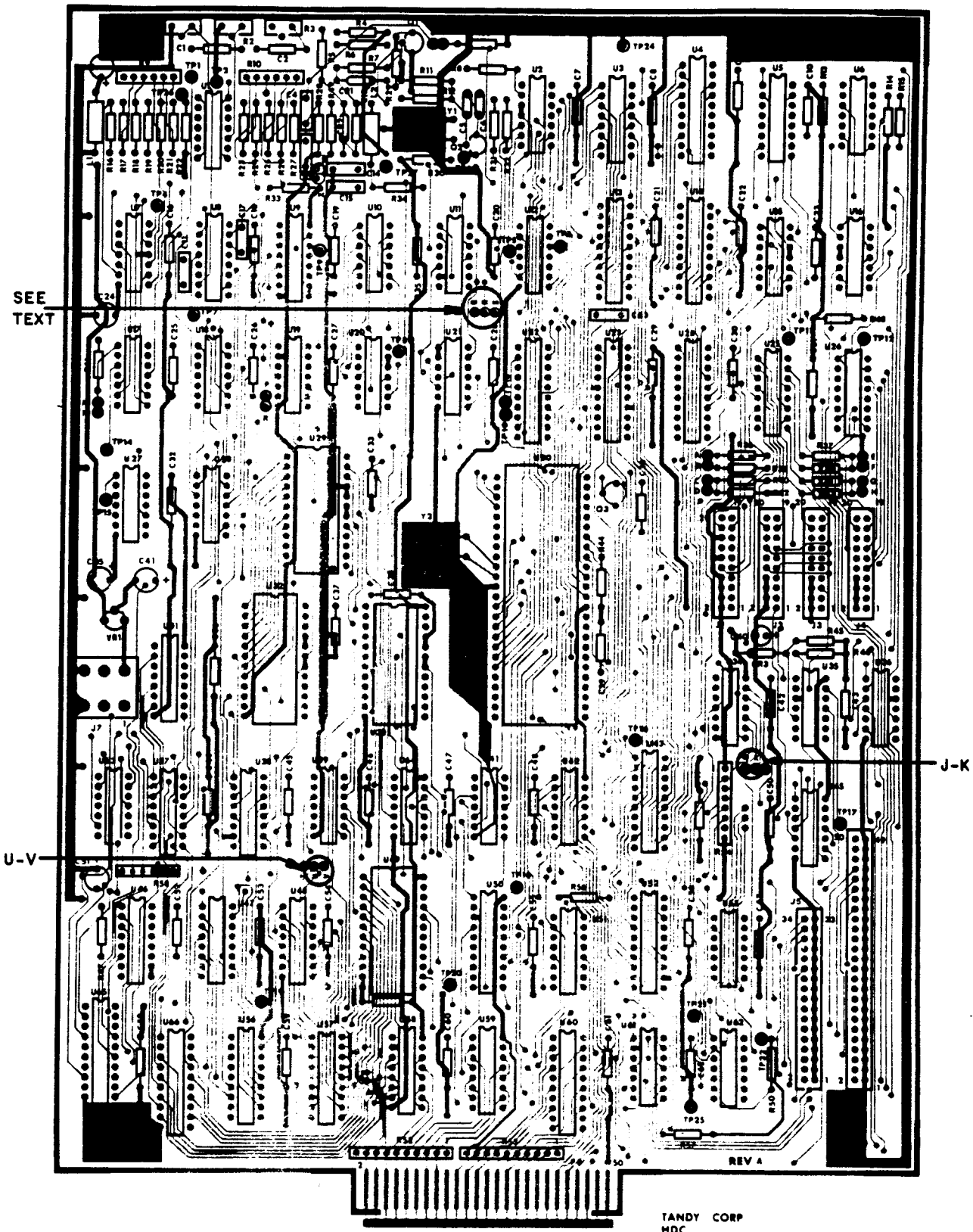

Figure 23. 8 MEG Hard Disk Controller Board.

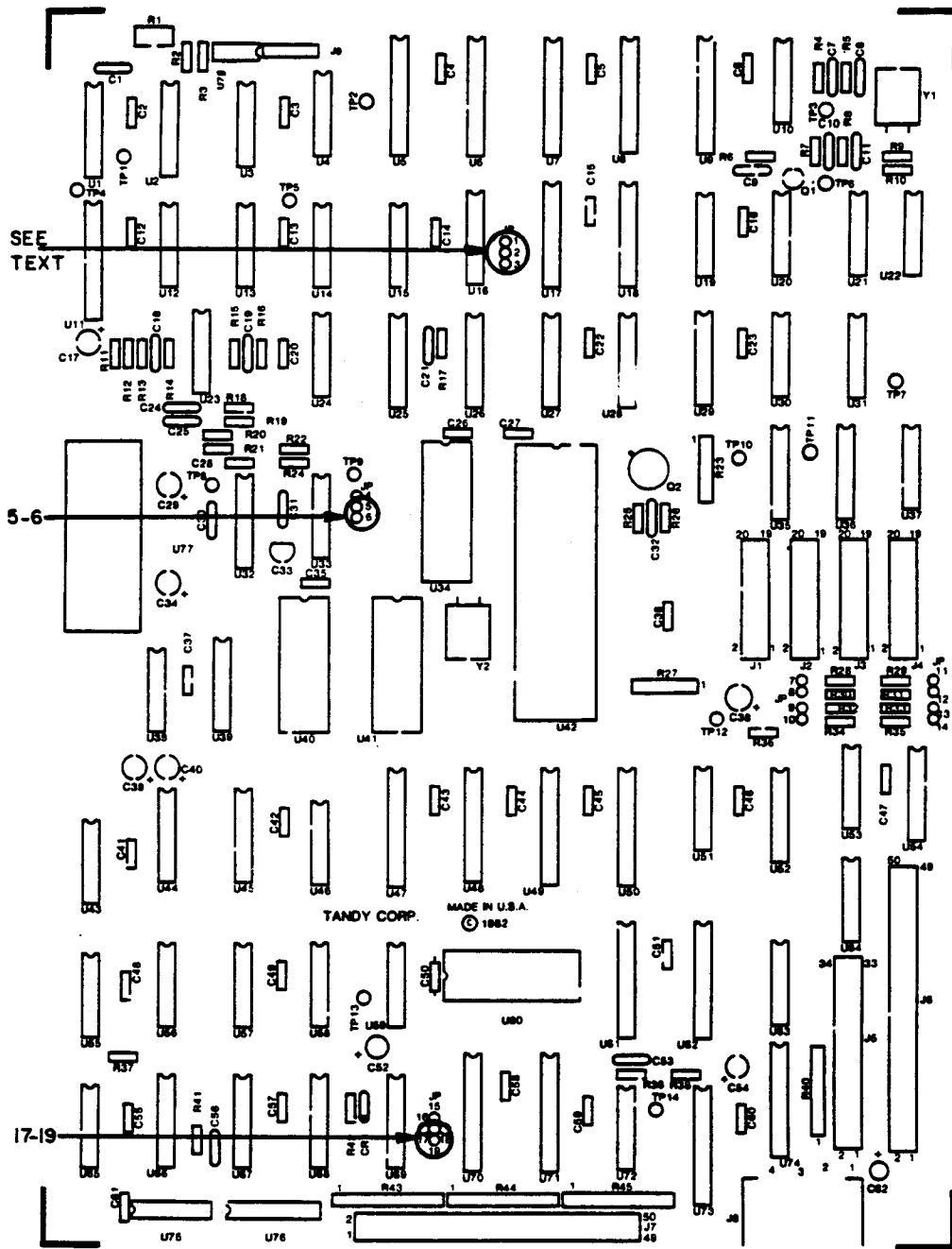

Figure 24. 5/12/External 15 MEG Hard Disk Controller Board.

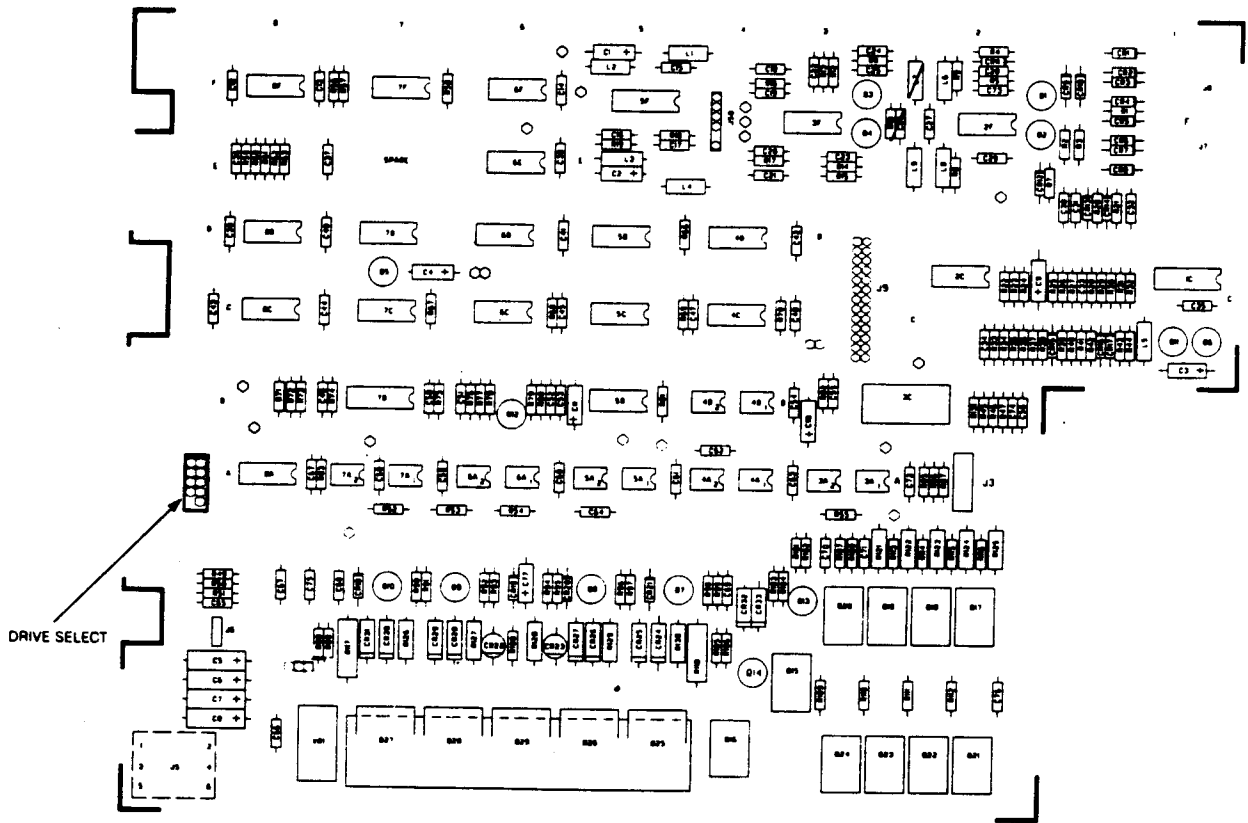

Figure 25. 8 MEG Hard Disk Drive Logic Board.

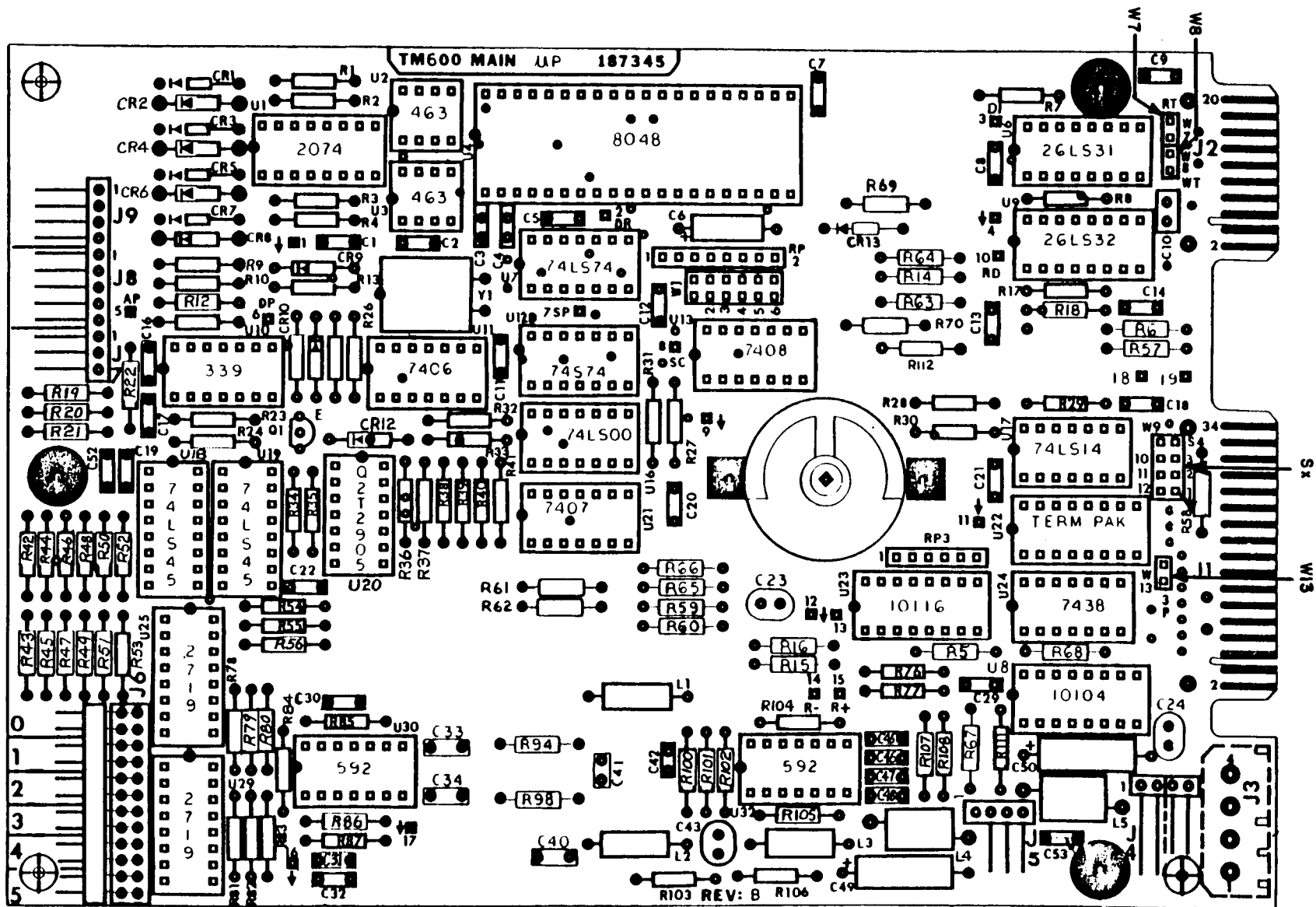

Figure 26. 12/15 MEG Hard Disk Drive Logic Board.

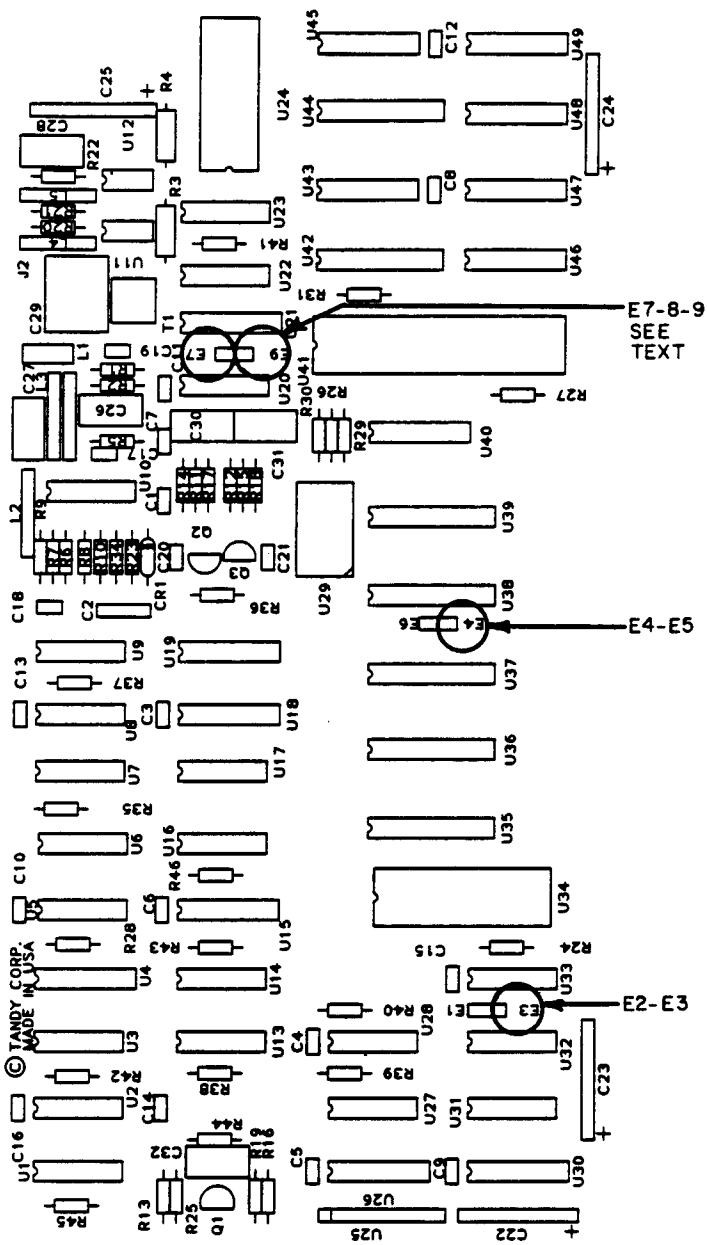

Figure 28. Arcnet Board.

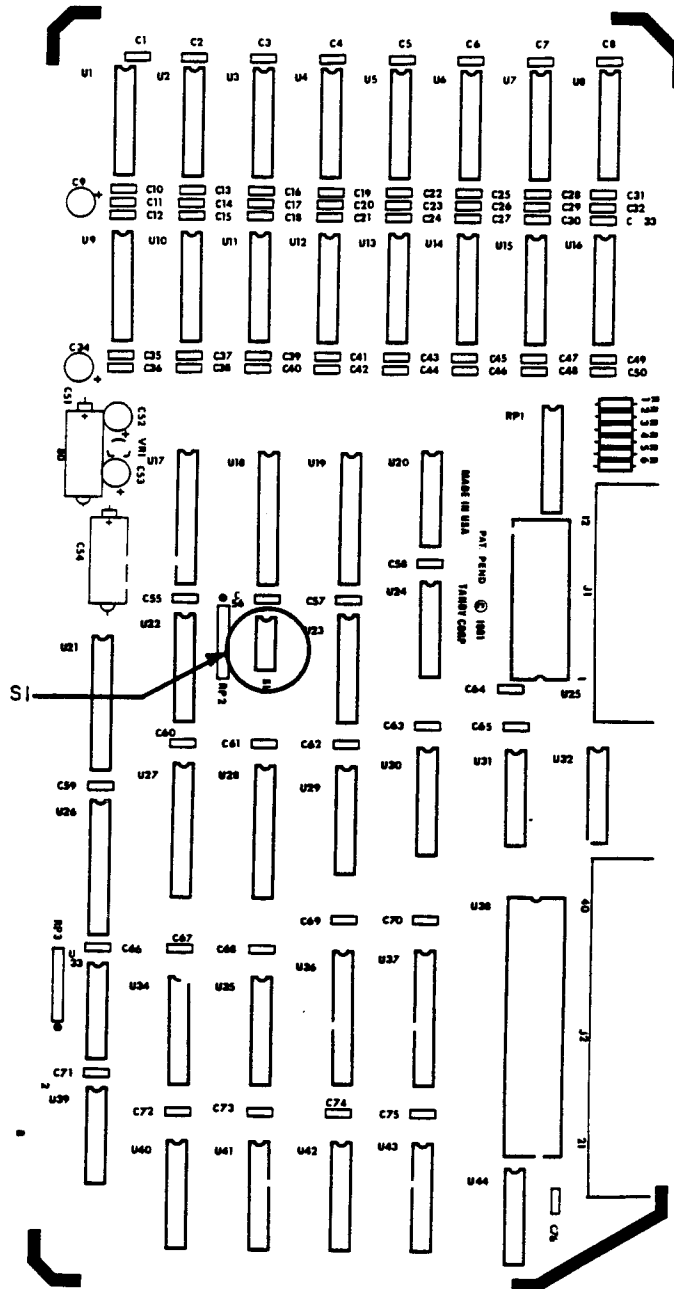

Figure 29. Hi-Res Graphics Board.

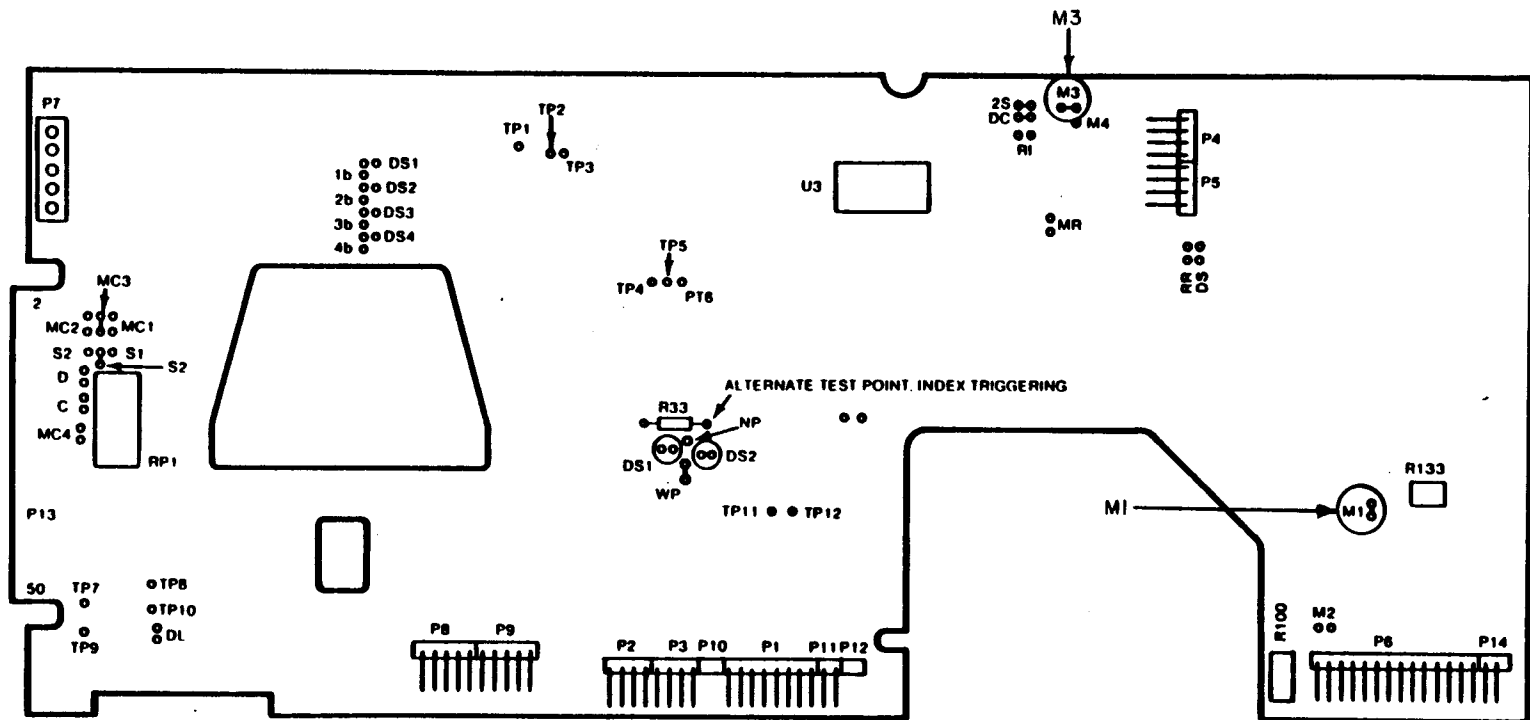

Figure 30. Tandon Thinline Floppy Drive Logic Board.

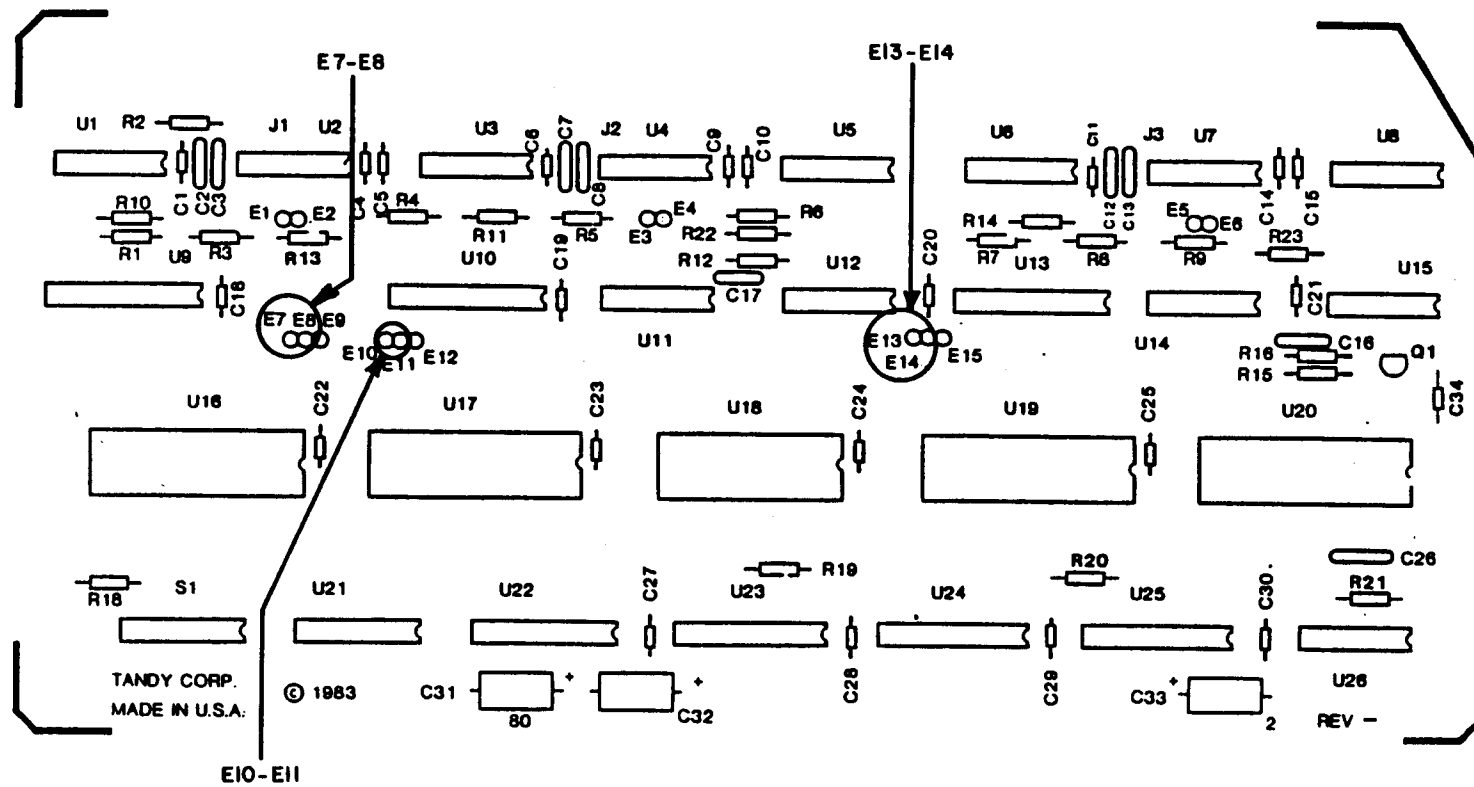

Figure 31. Multi-Terminal Board.

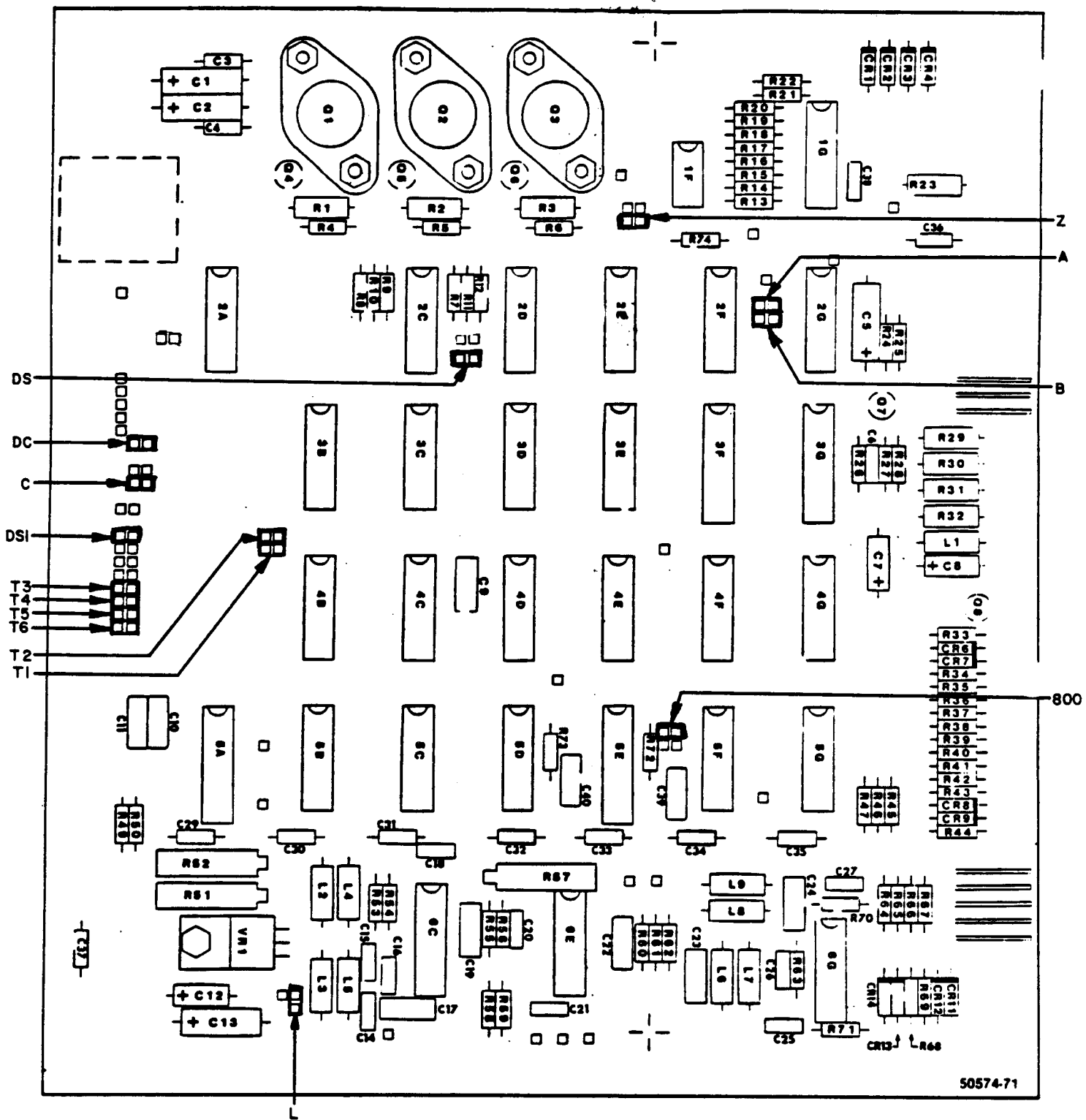

Figure 32. Shugart Floppy Drive Logic Board (Discrete).

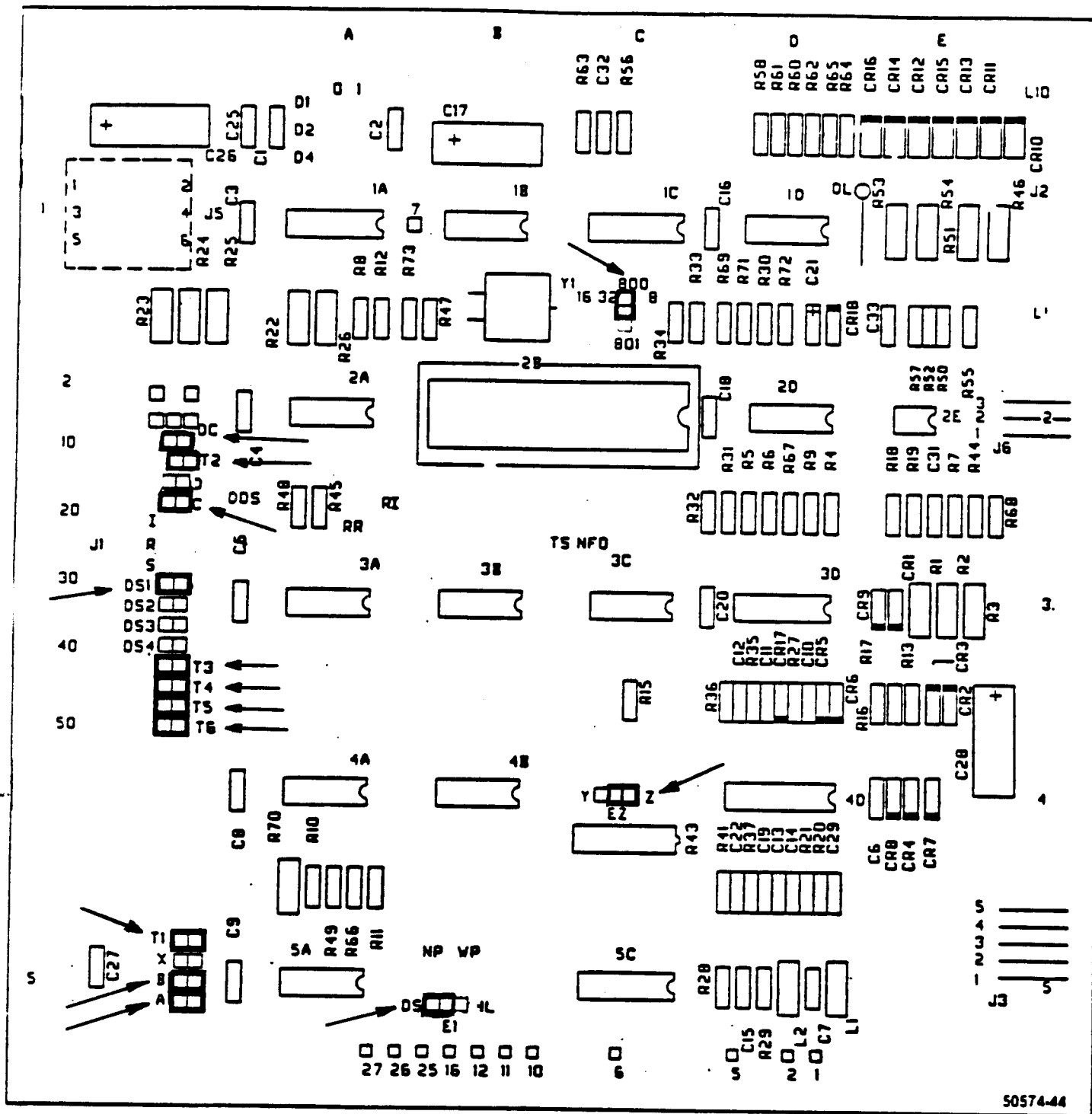

Figure 33. Shugart Floppy Drive Logic Board (Early Style LSI).

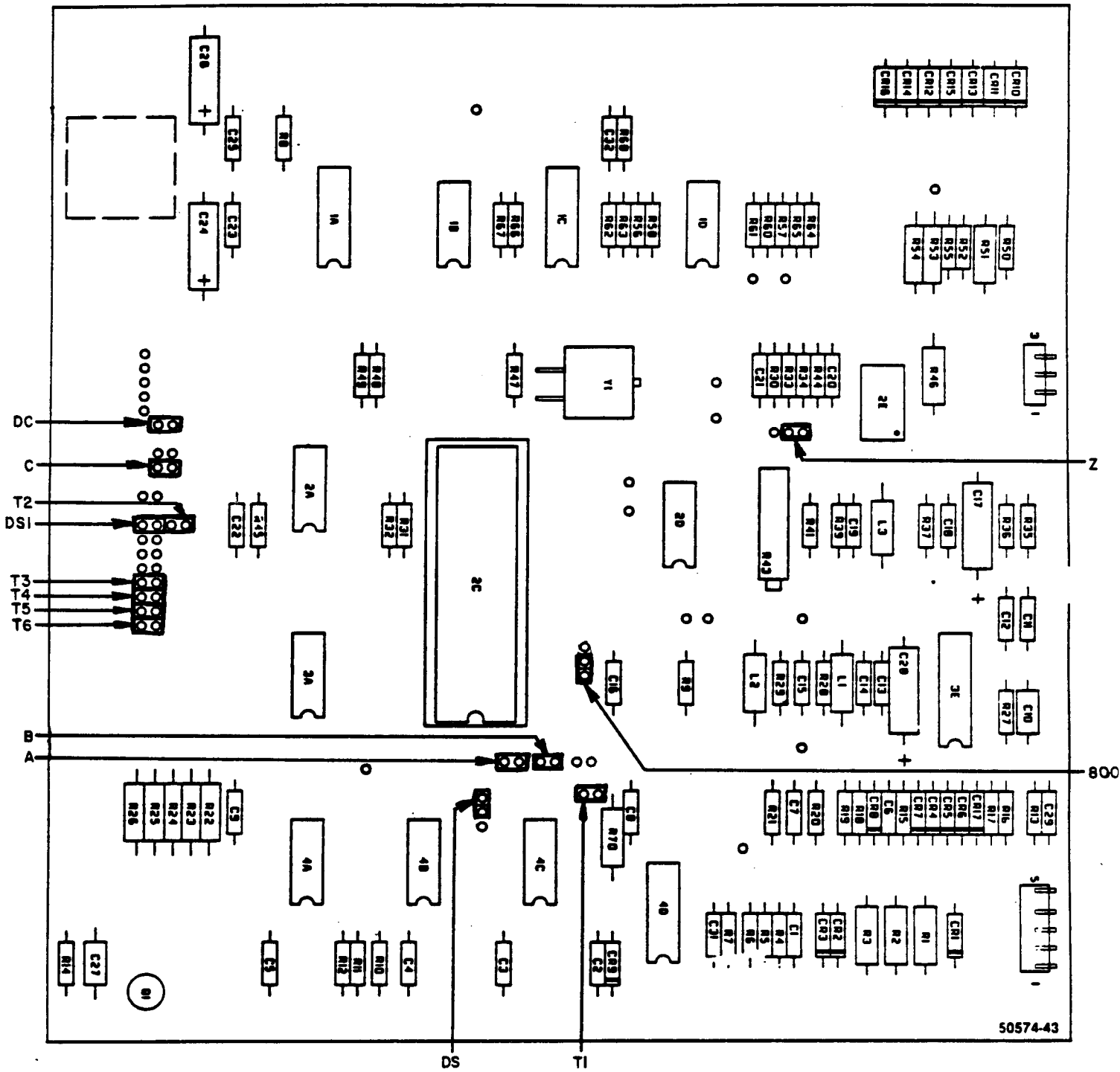

Figure 34. Shugart Floppy Drive Logic Board (Late Style LSI).

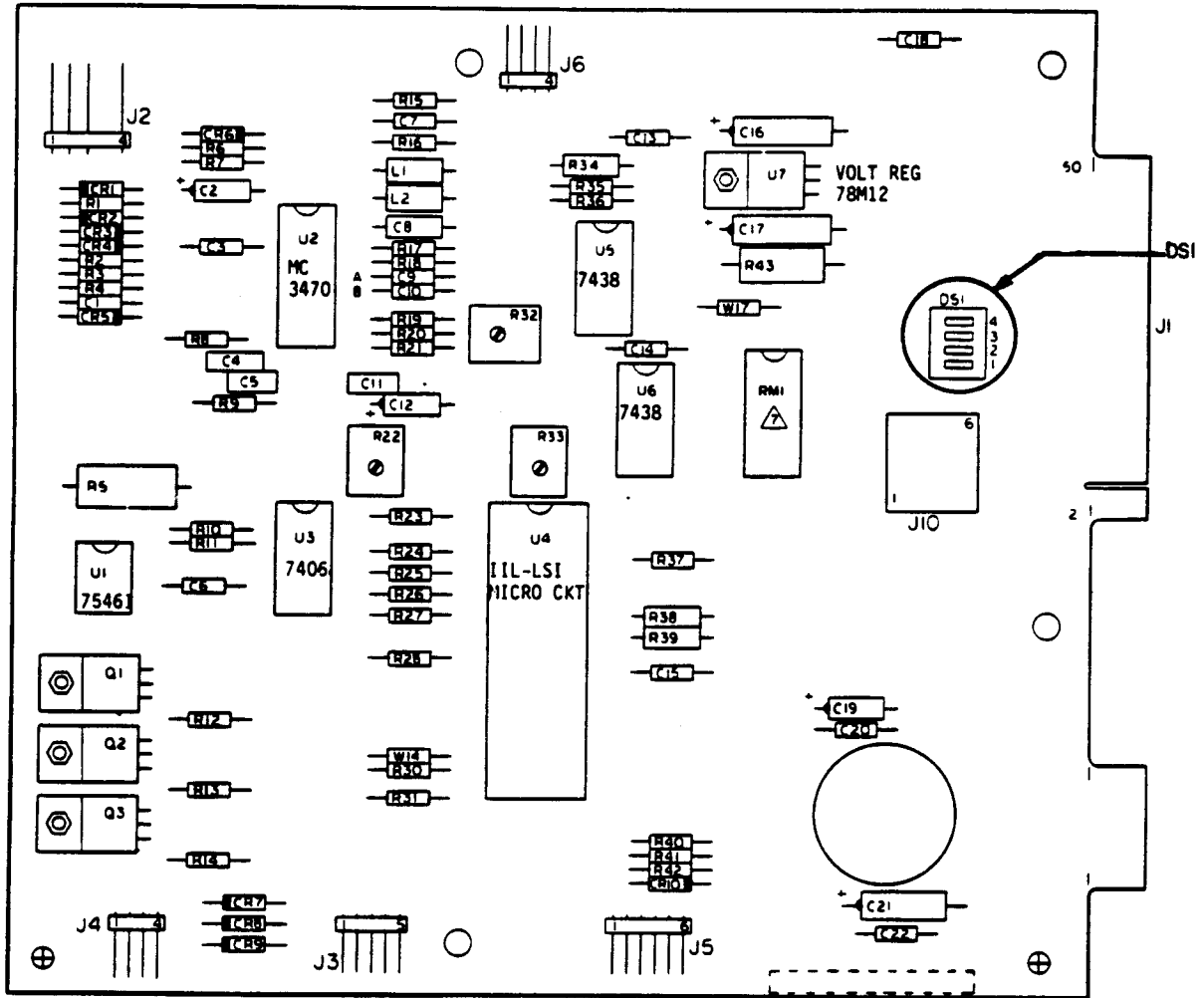

Figure 36. CDC Floppy Drive Logic Board (LSI).

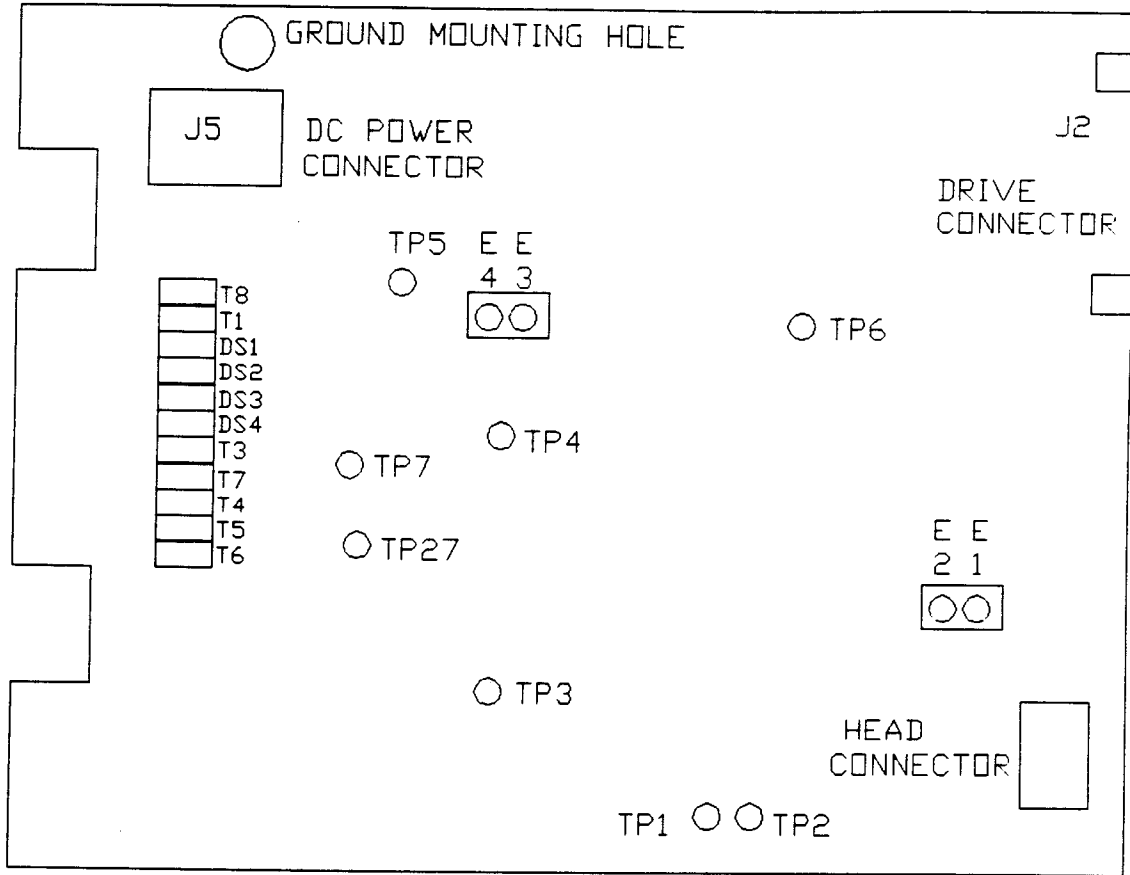

Figure 37. TPI Drive Logic Board

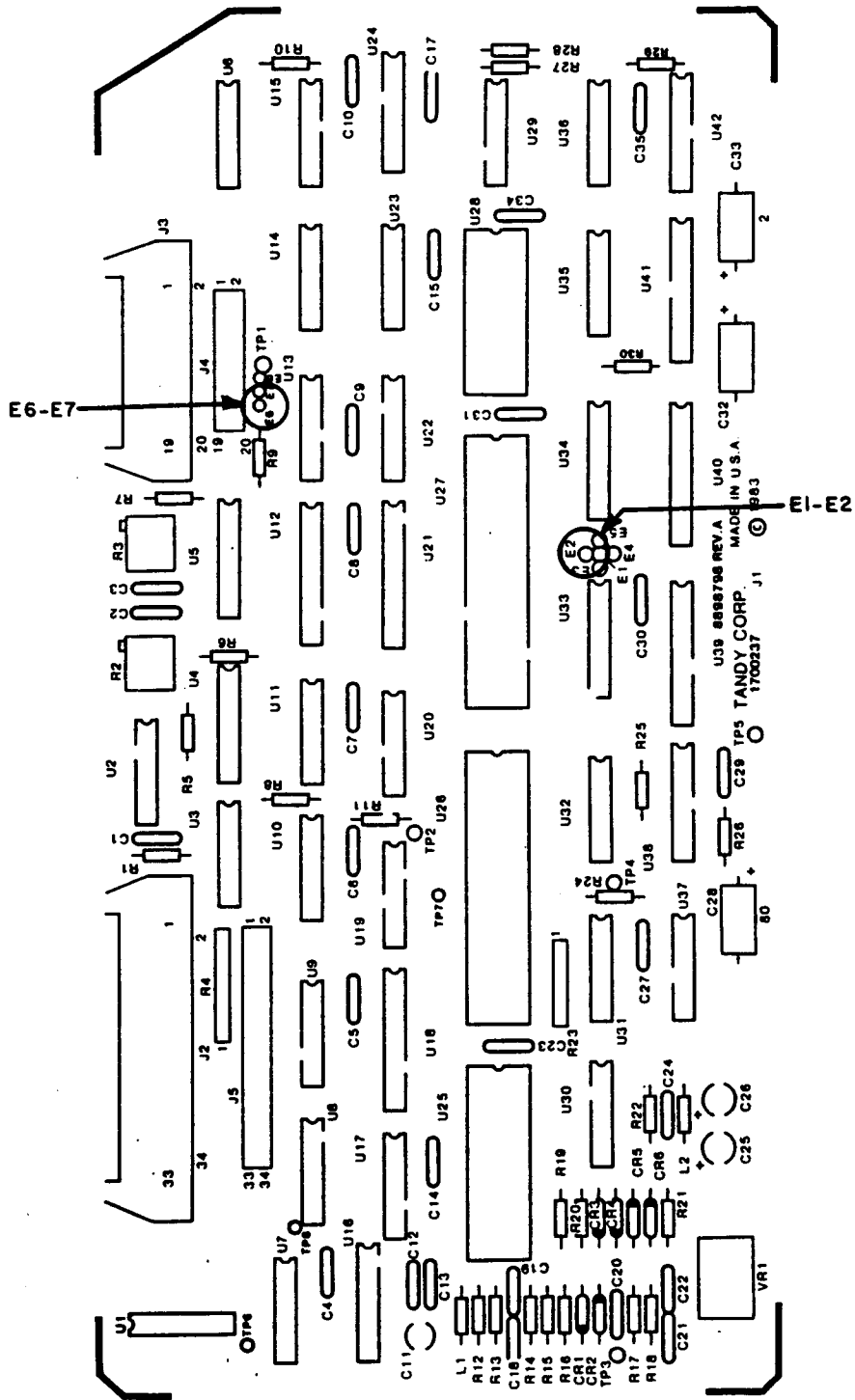

Figure 38. 15 MEG Internal Hard Disk Controller/Interface Board.

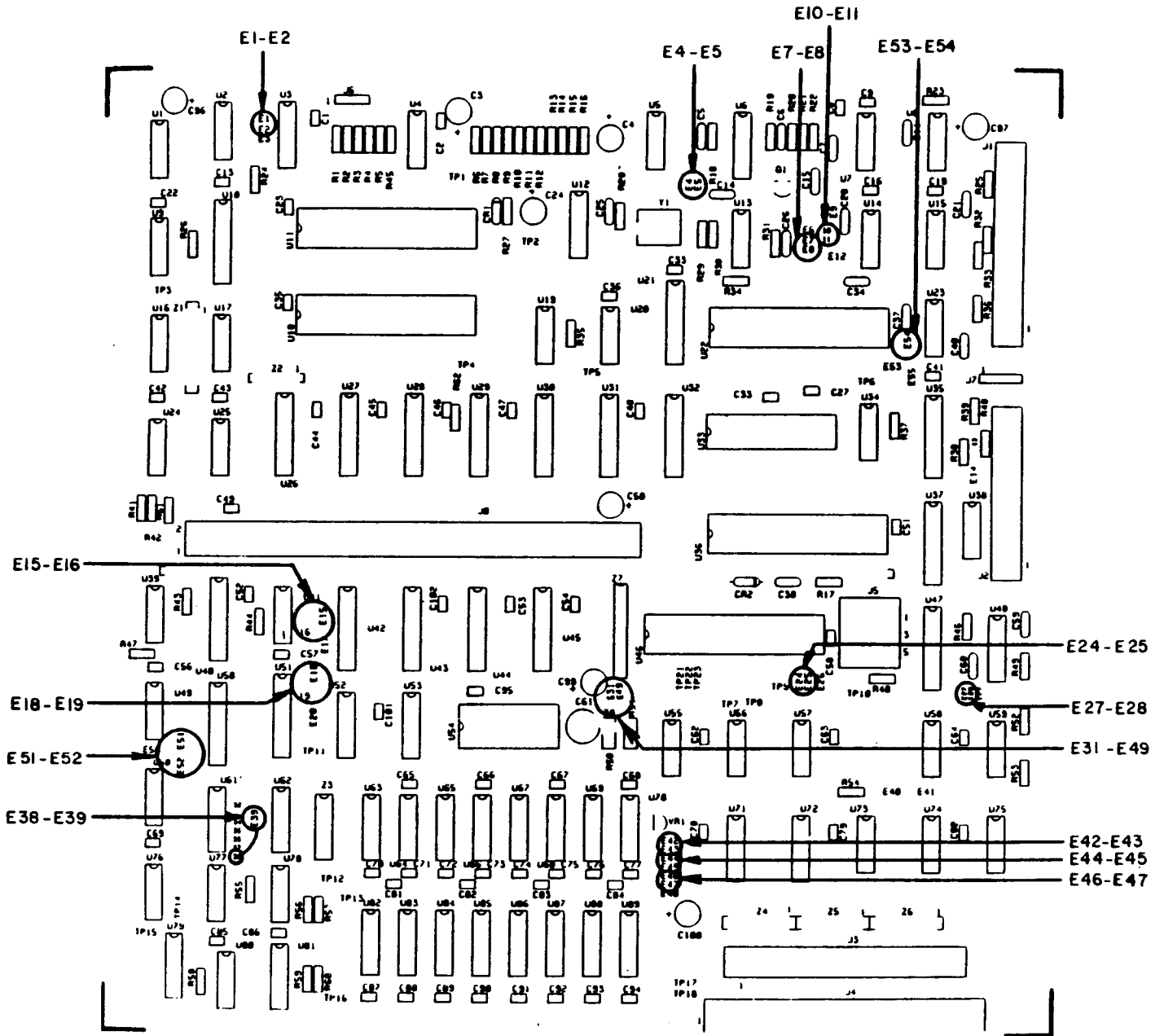

Figure 39. Model 16B Main Logic Board.

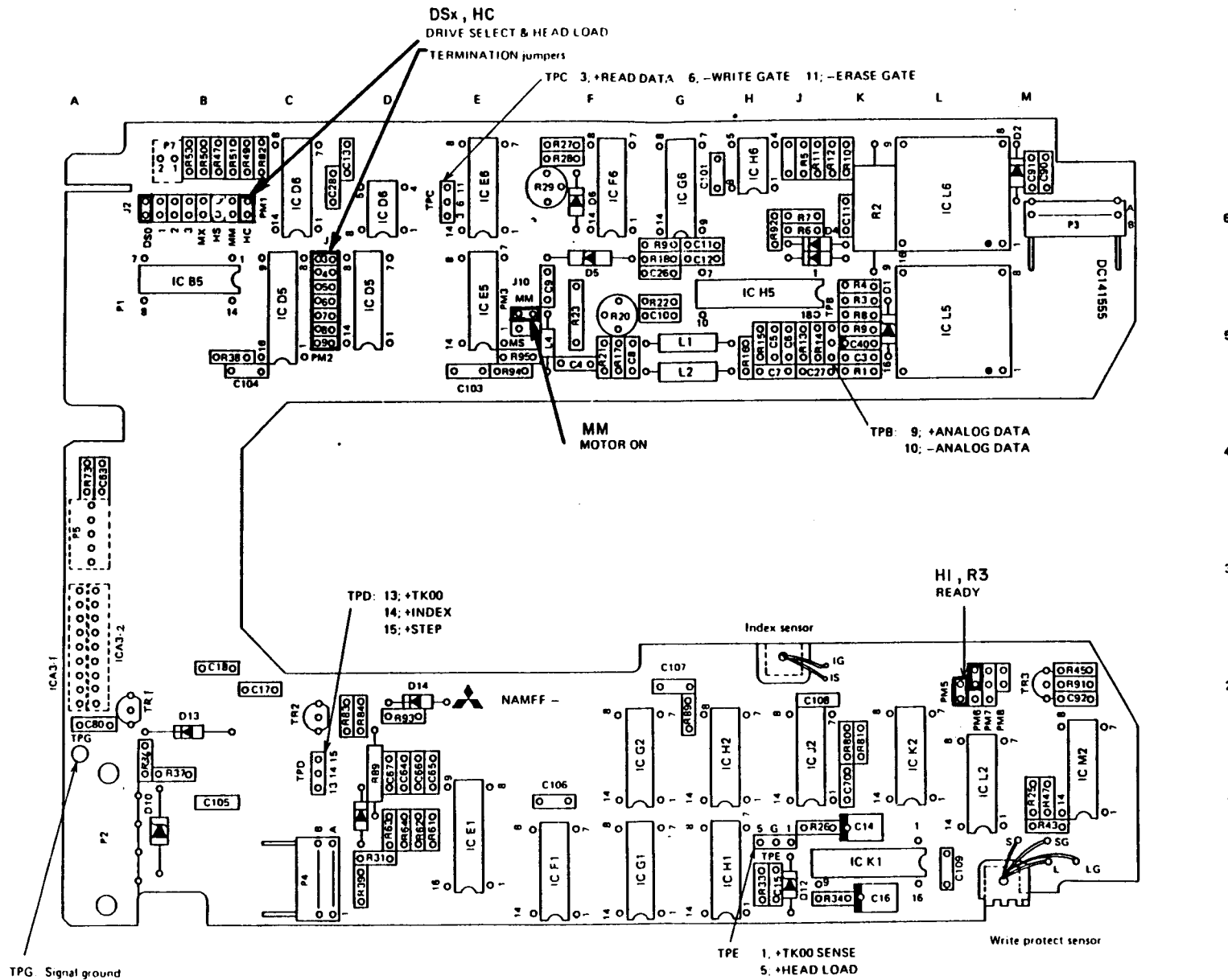

Figure 40. Mitsubishi Floppy Drive Logic Board

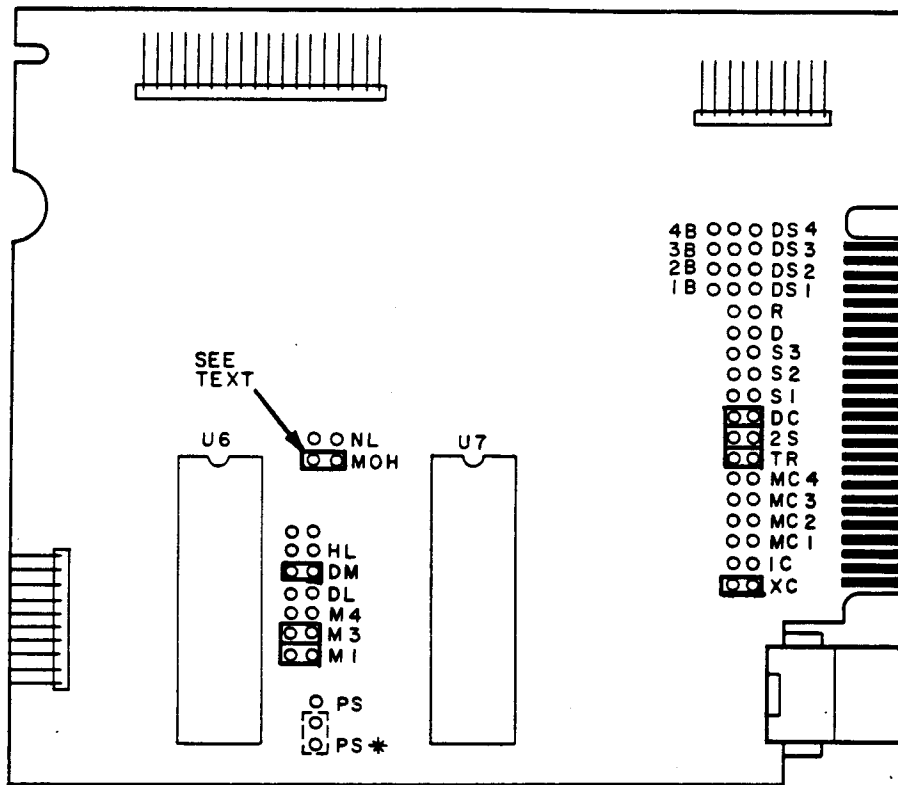

Figure 41. TM848 Direct Drive Floppy Drive Logic Board.

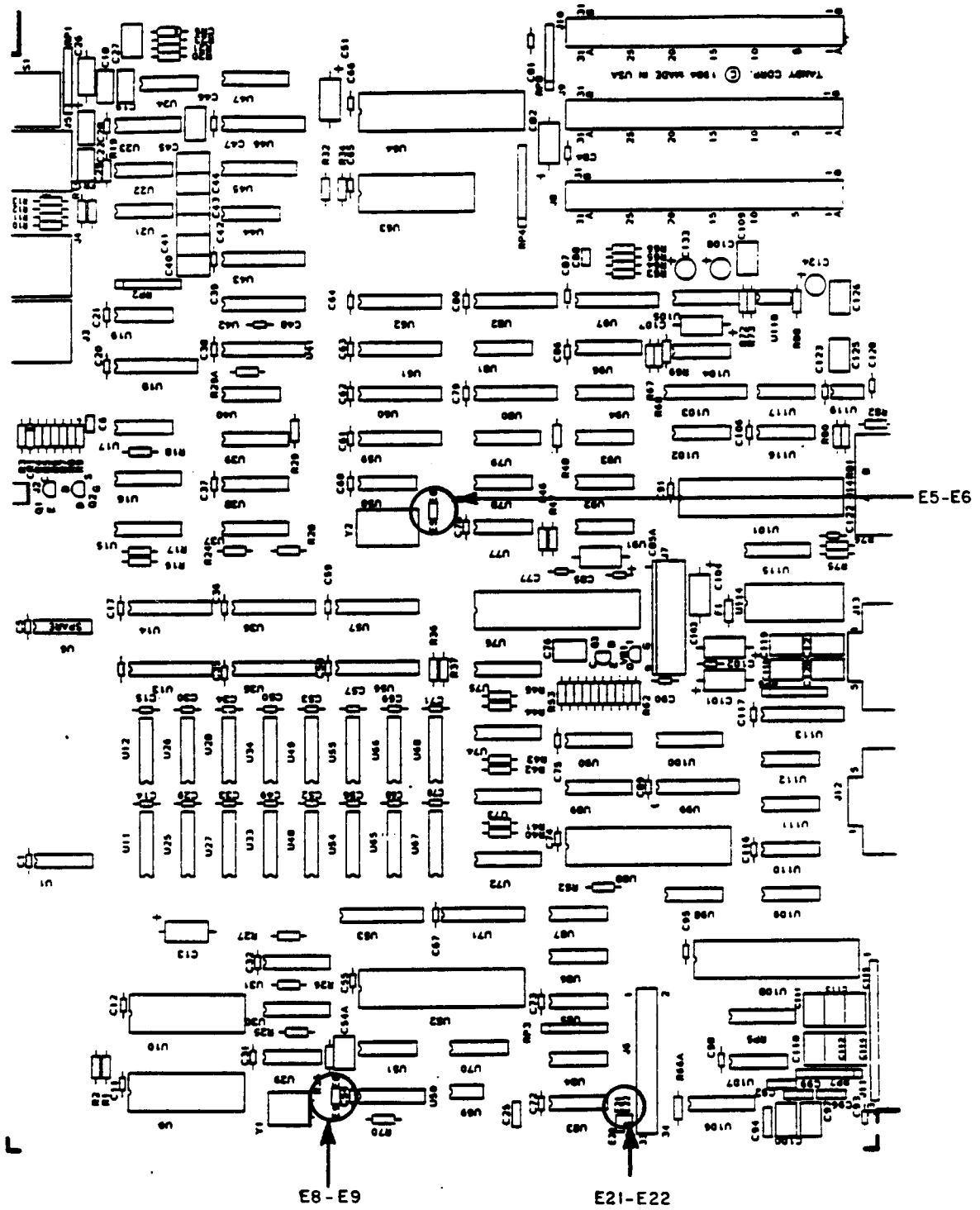

Figure 42. Tandy 1000 Main Logic Board.

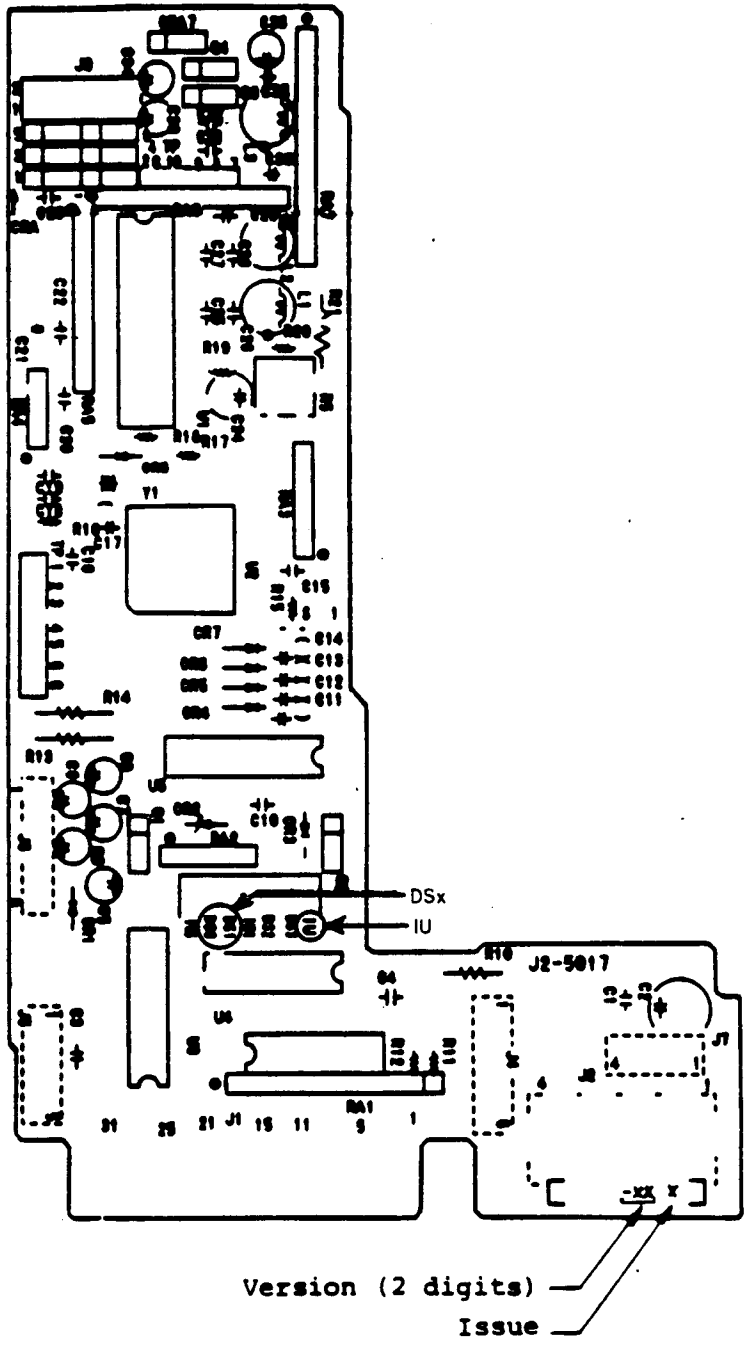

Figure 43. TEAC FD-54B 5 1/4" Floppy Drive Logic Board.

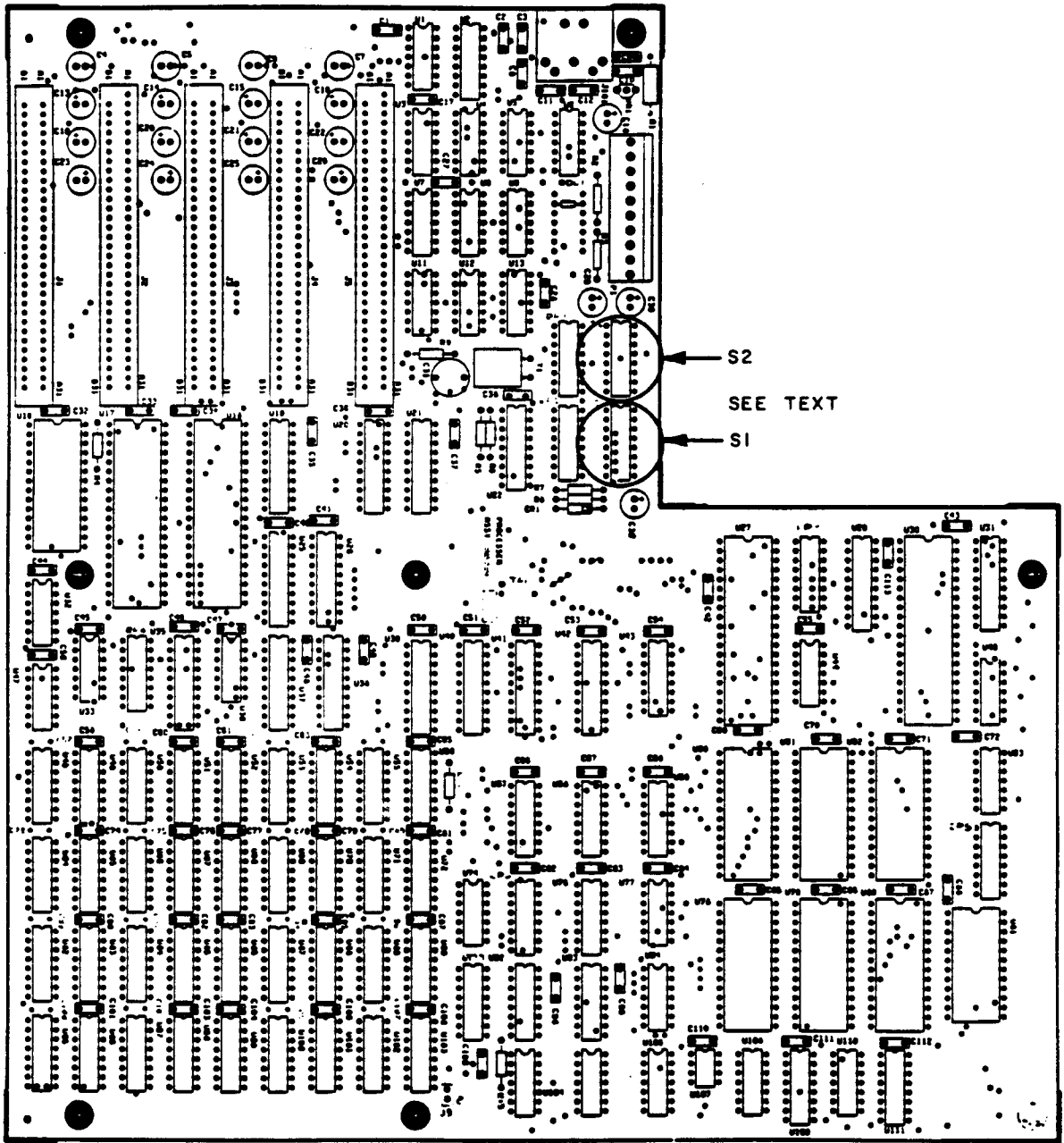

Figure 44. Tandy 1200 Main Logic Board.

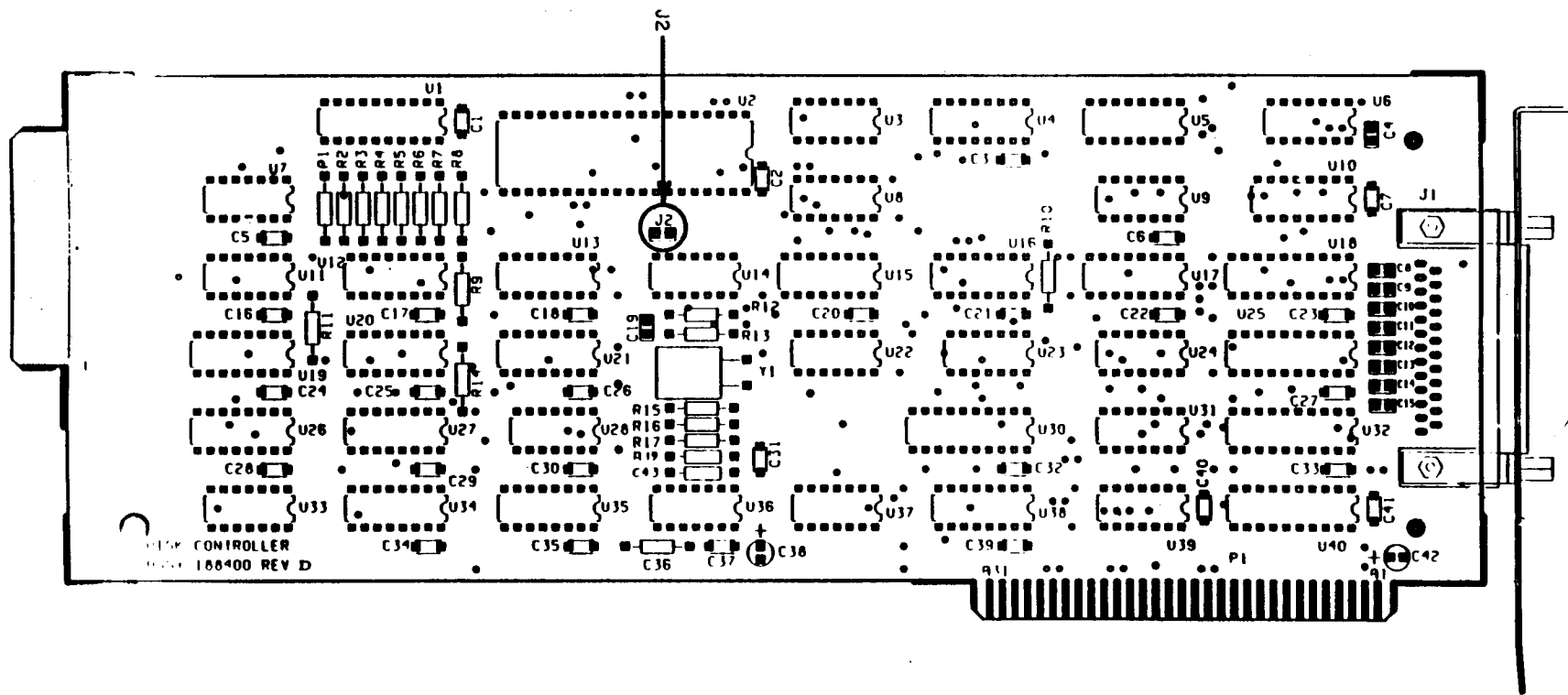

Figure 45. Tandy 1200 Floppy Disk Controller Board.

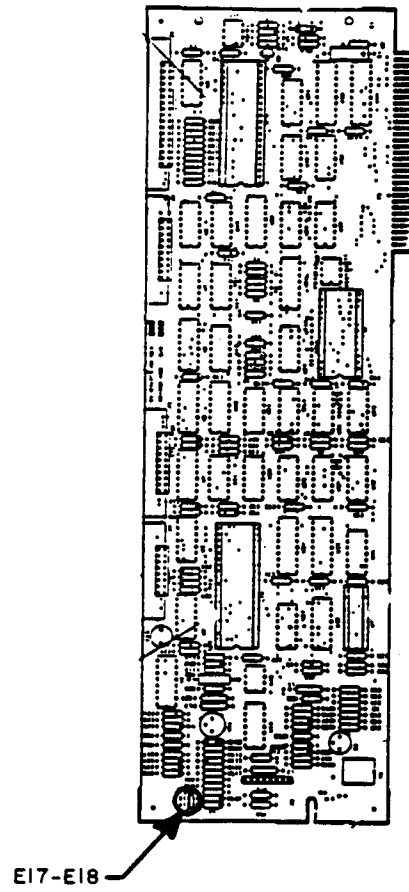

Figure 46. Tandy 1200 Hard Disk Controller Board.

PROGRAMMABLE SHUNT SOCKET 1E

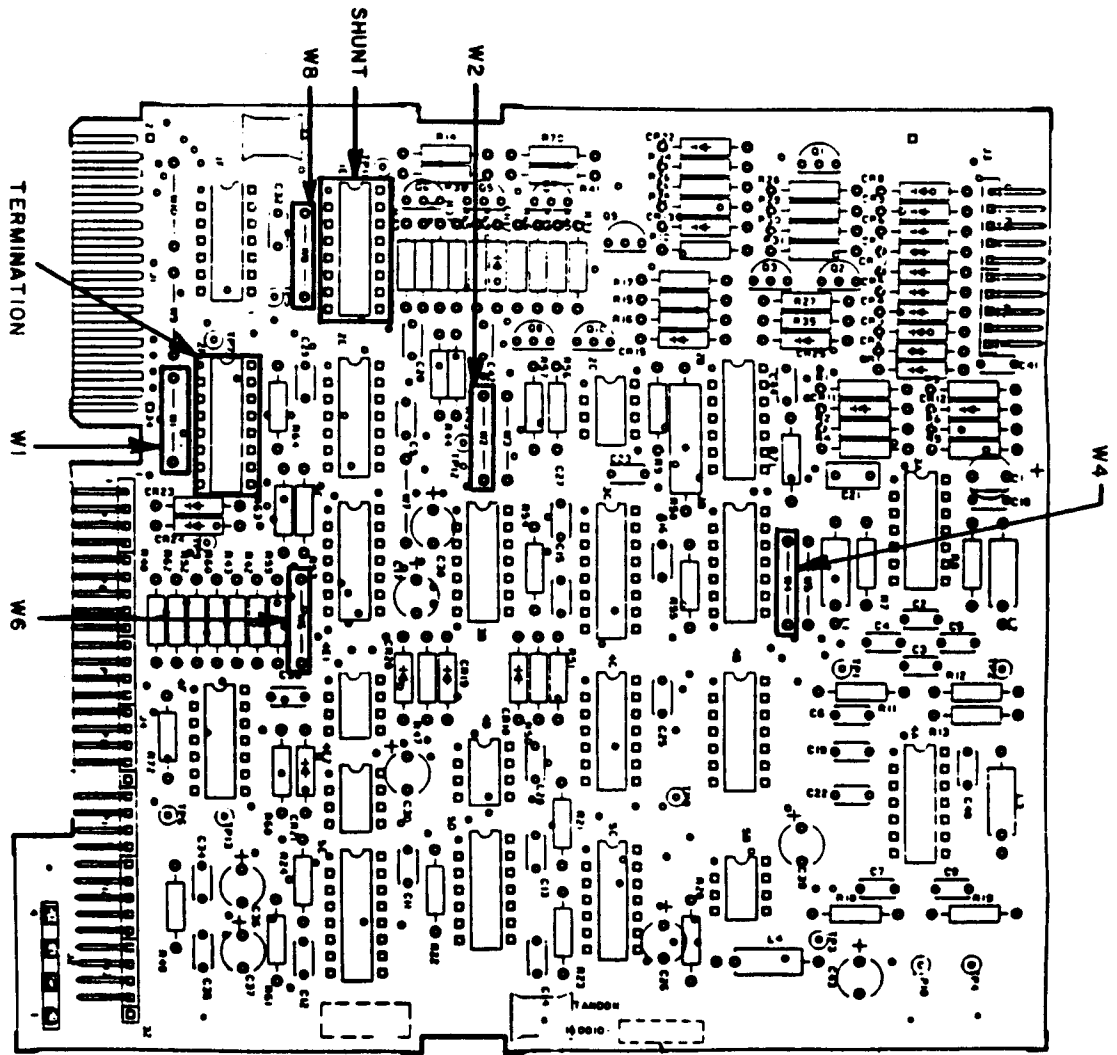
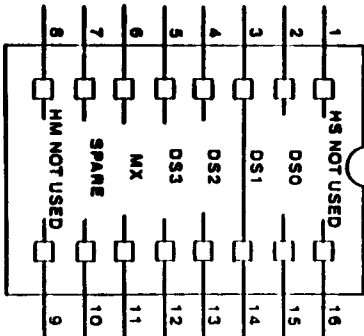

Figure 47. Tandon TM100-2 5 1/4" Floppy Drive Logic Board.

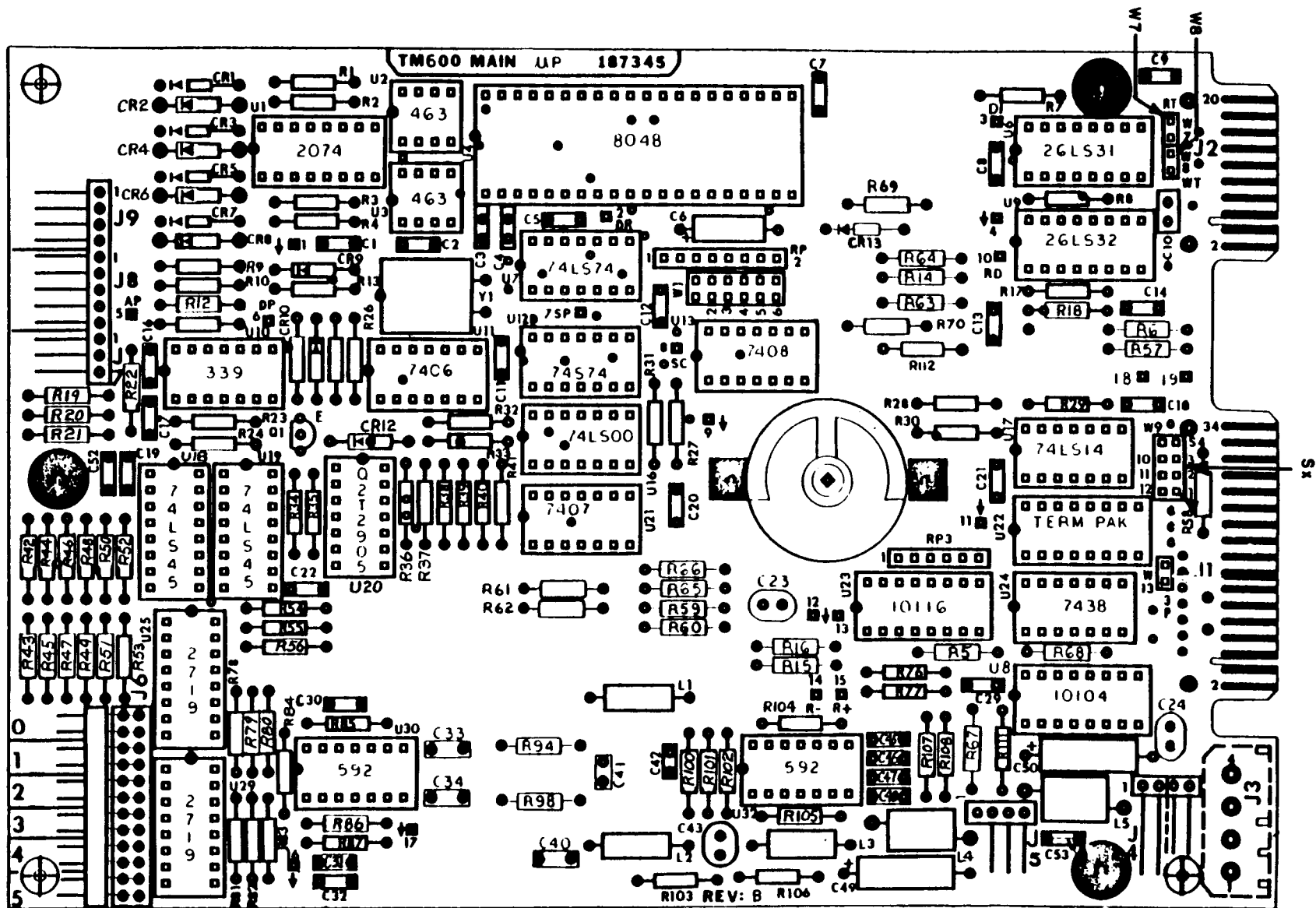

Figure 48. 10 MEG Hard Disk Drive Logic Board.

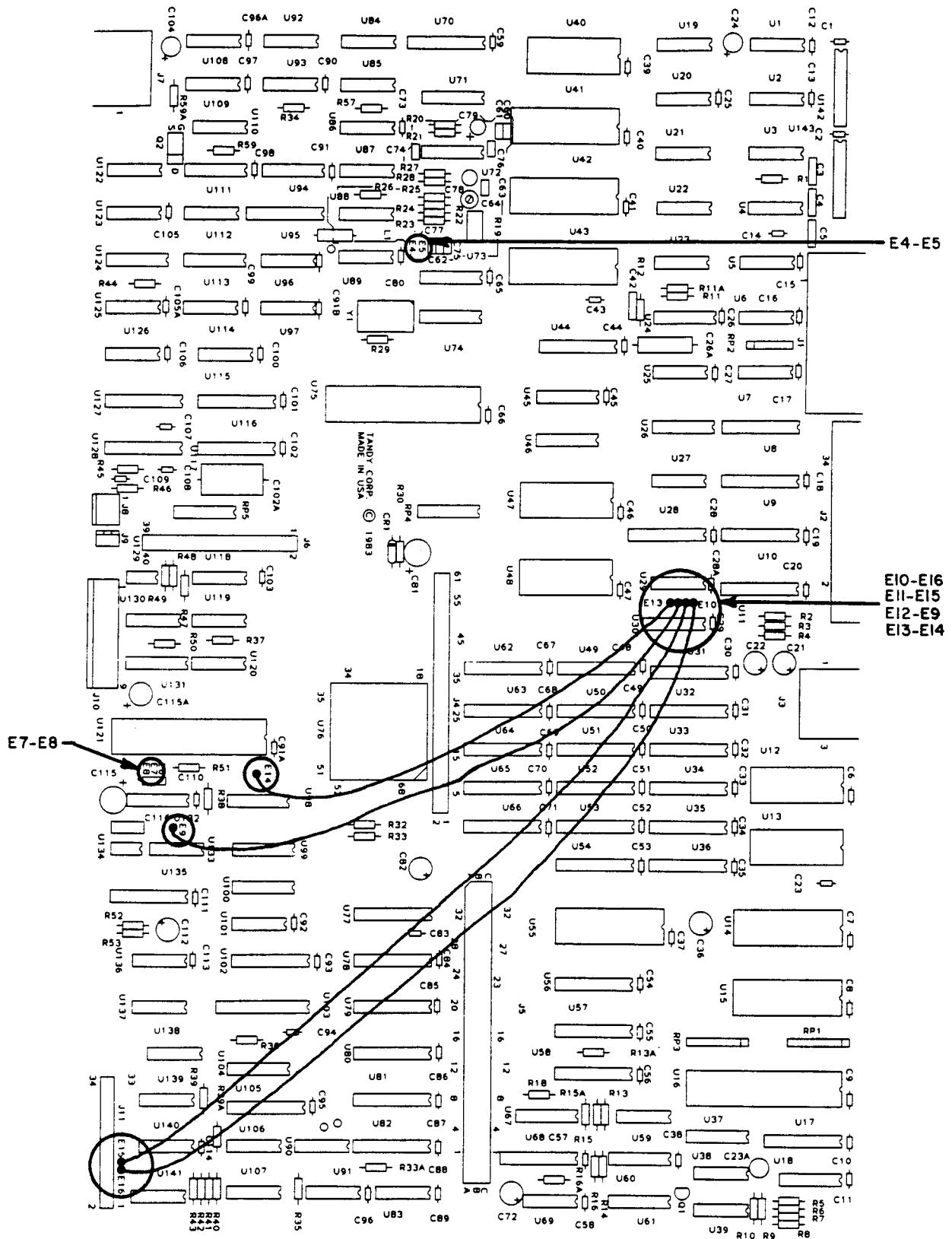

Figure 49. Tandy 2000 Main Logic Board.

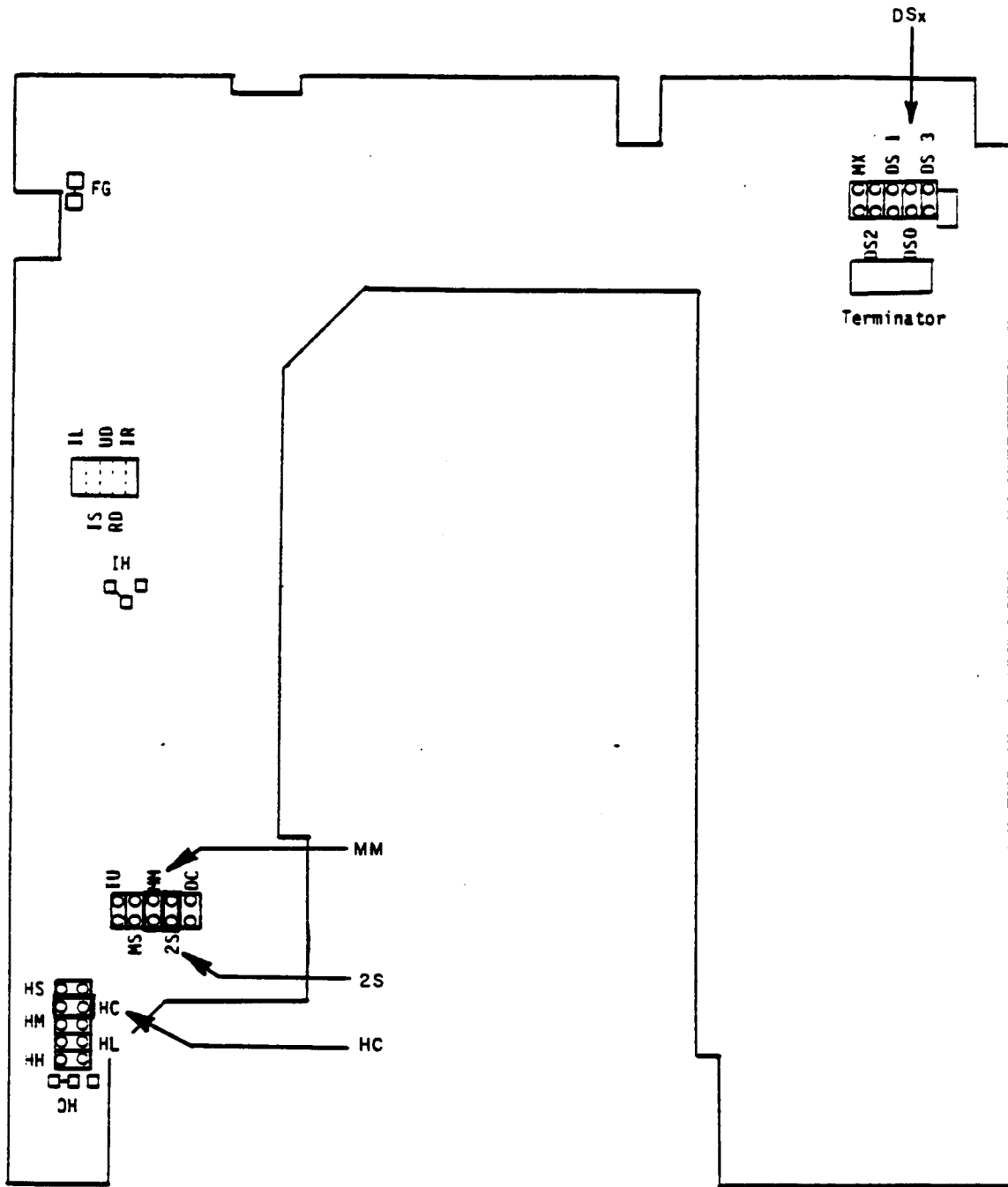

Figure 50. Mitsubishi M4853-1 Floppy Drive Logic Board.

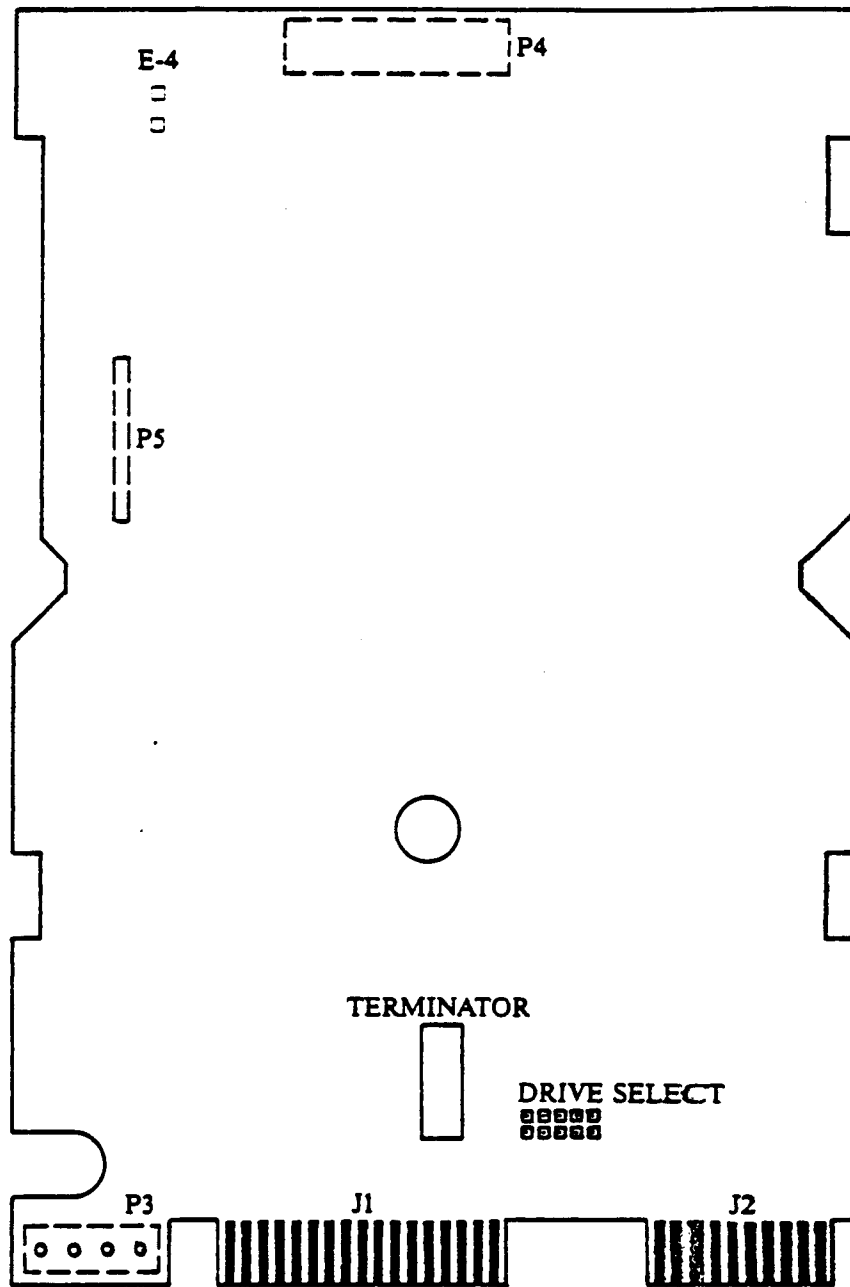

Figure 51. 35 MEG Hard Disk Drive Logic Board.

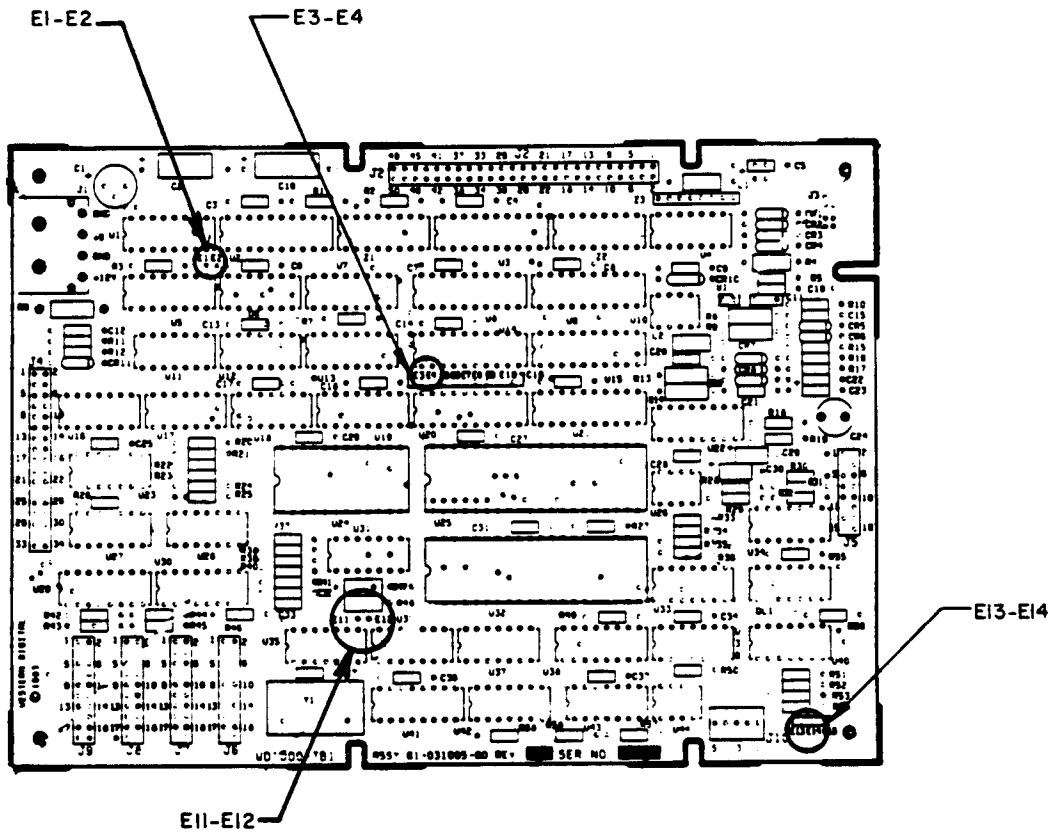

Figure 52. WD1010 External Controller Board.

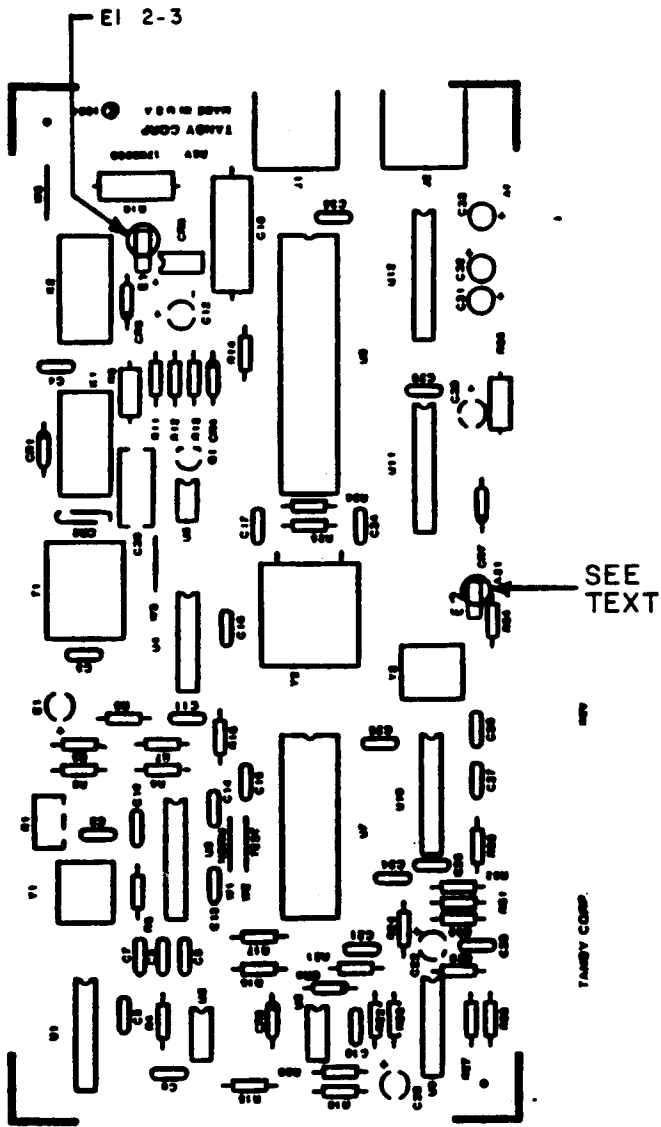

Figure 53. Tandy 1000 Modem Board.

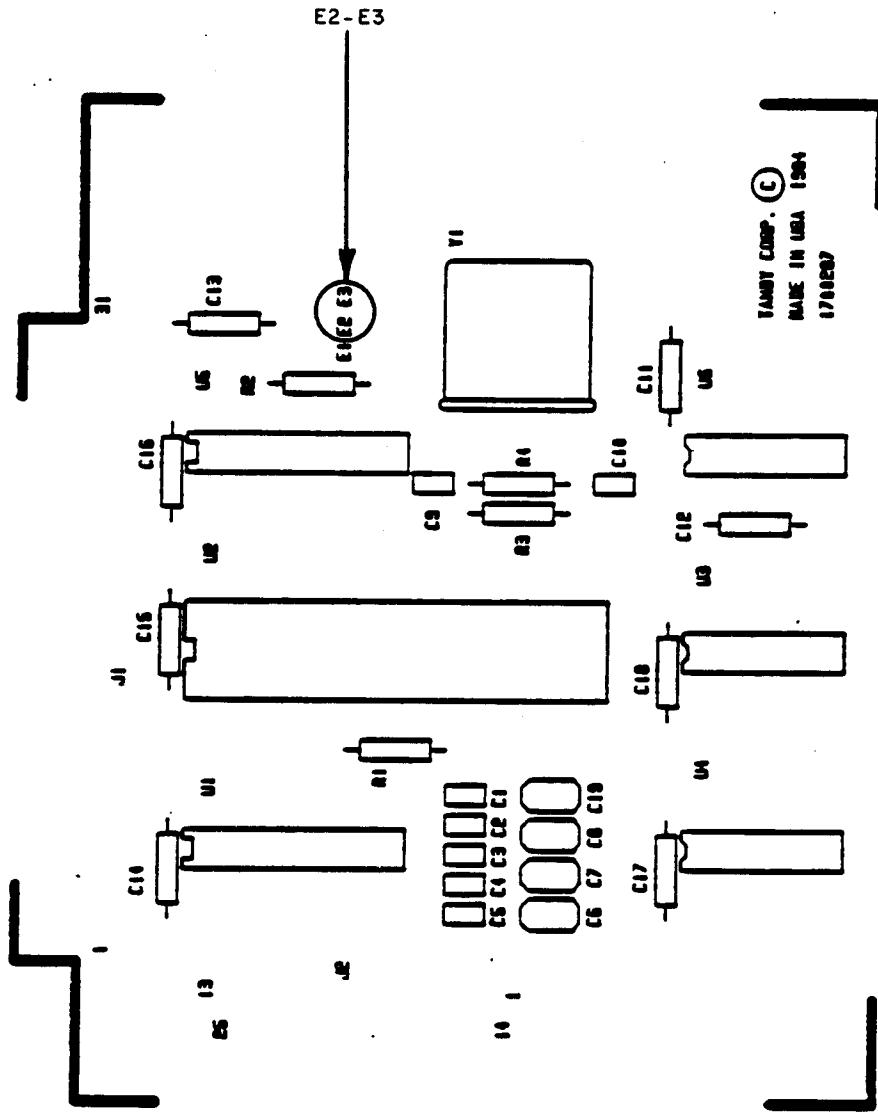

Figure 54. Tandy 1000 RS-232 Board.

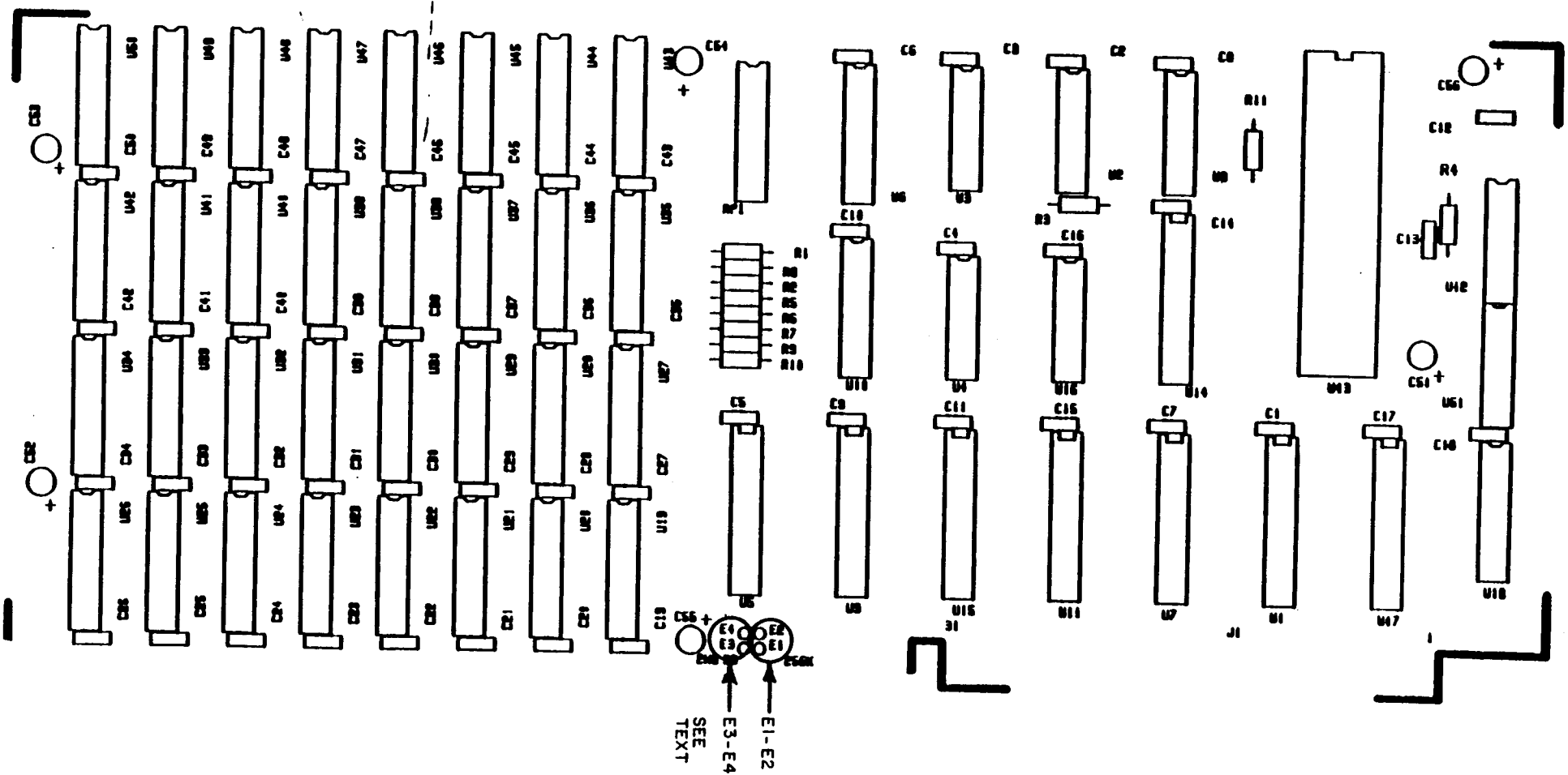

Figure 56. Tandy 1000 Second External RAM Board.

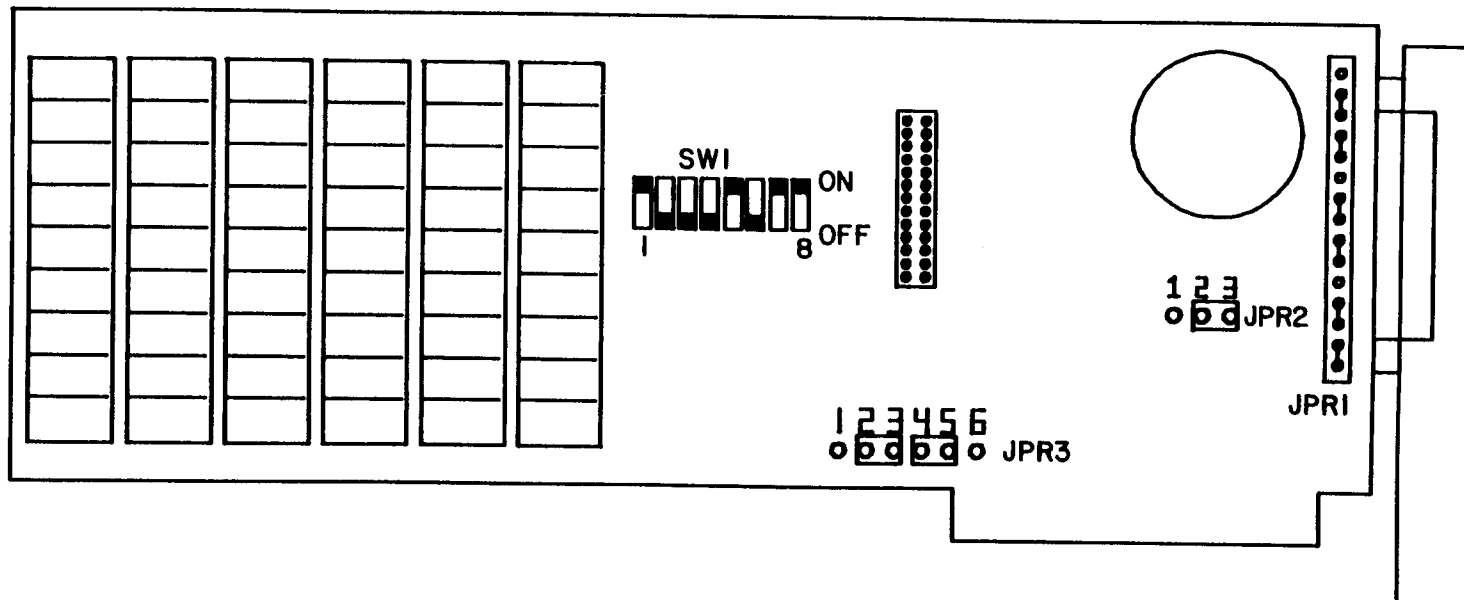

Figure 57. Captain Multi-Function Board.

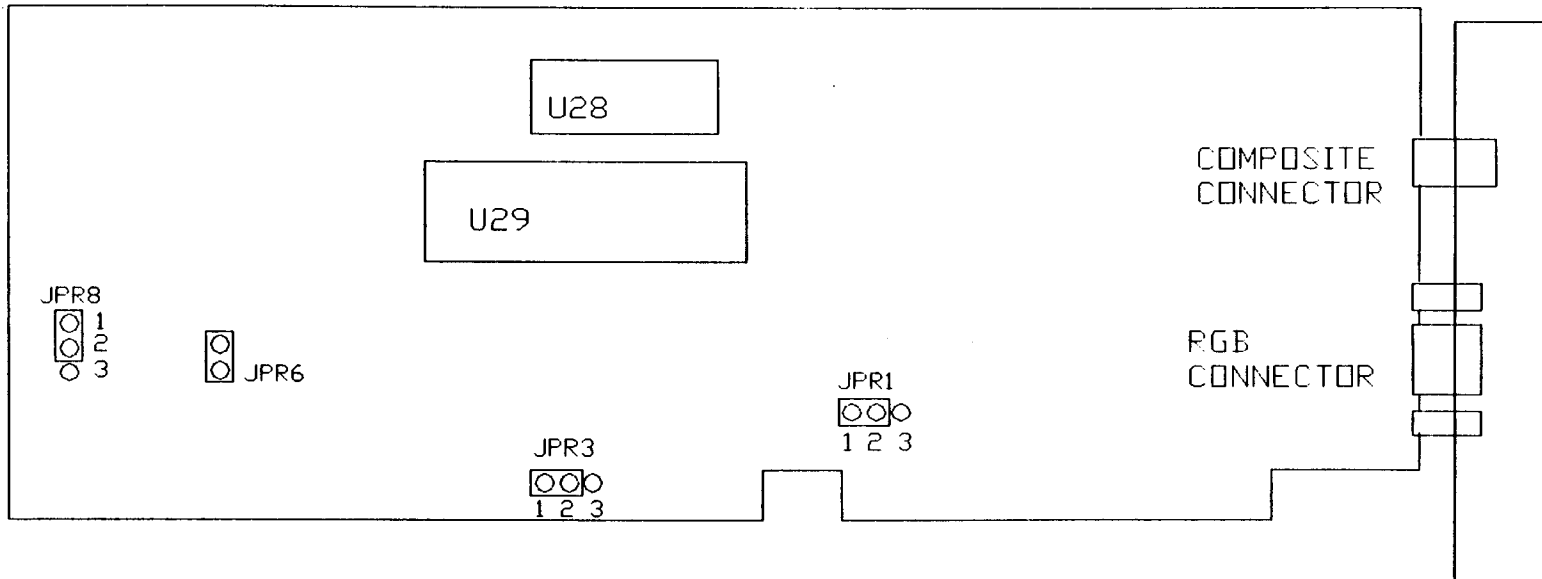

Figure 58. Tandy 1200 Graphics Tender Board

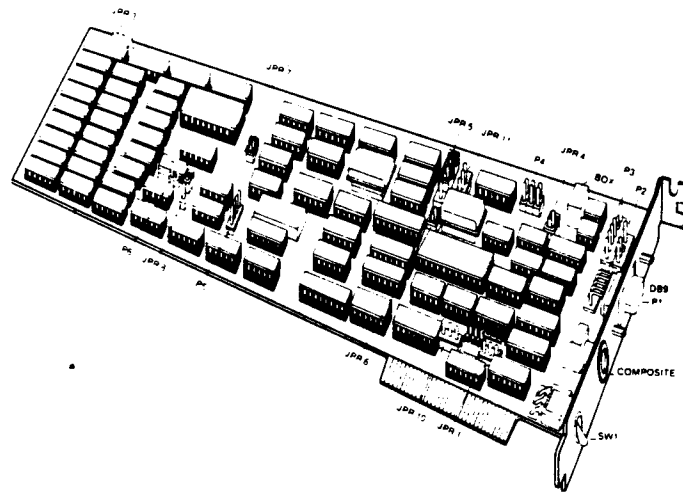

Figure 59. Tandy 1200 Graphics Master Board.

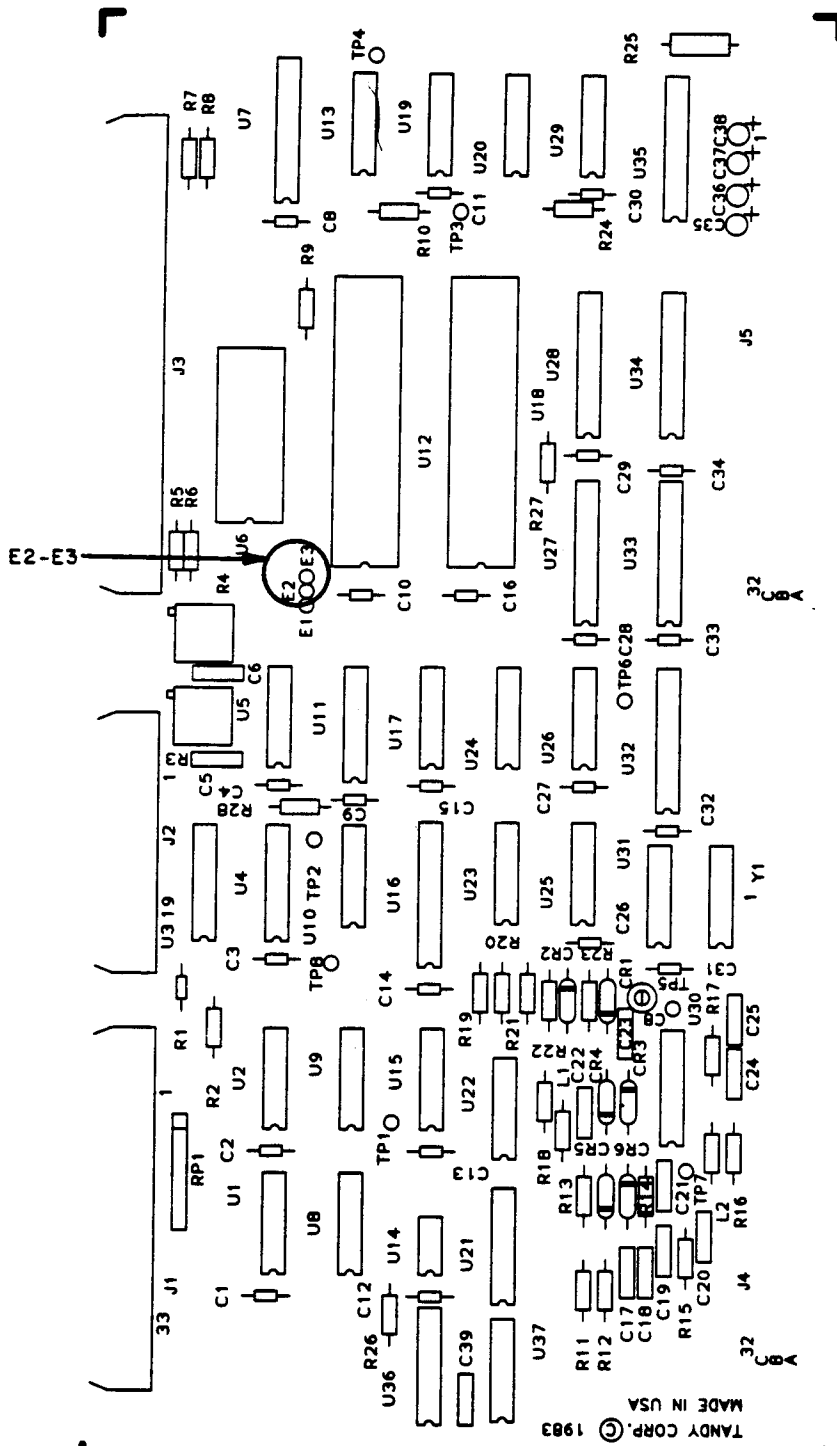

Figure 60. Tandy 2000 Hard Disk Controller Board.

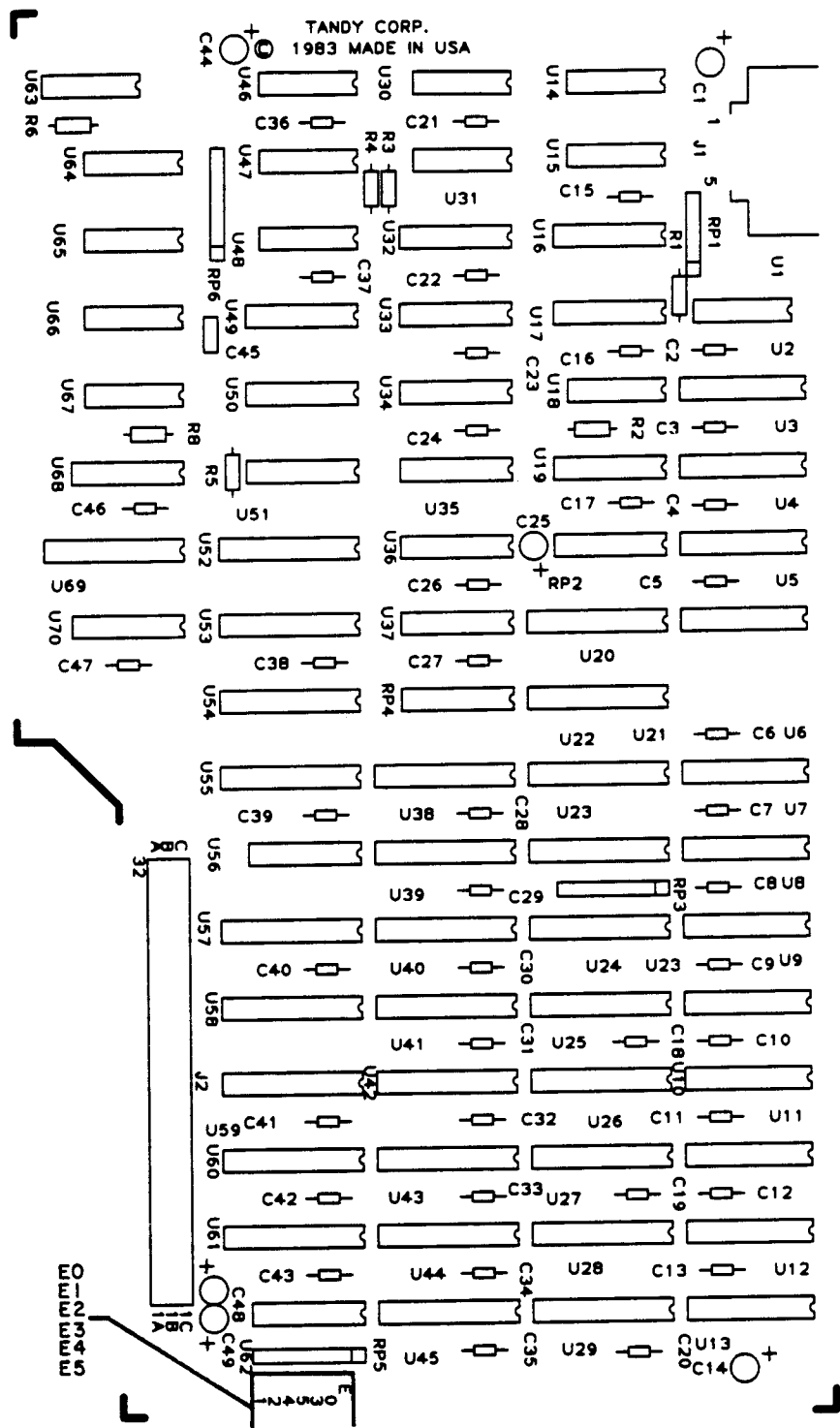

Figure 61. Tandy 2000 Monochrome Graphics Board.

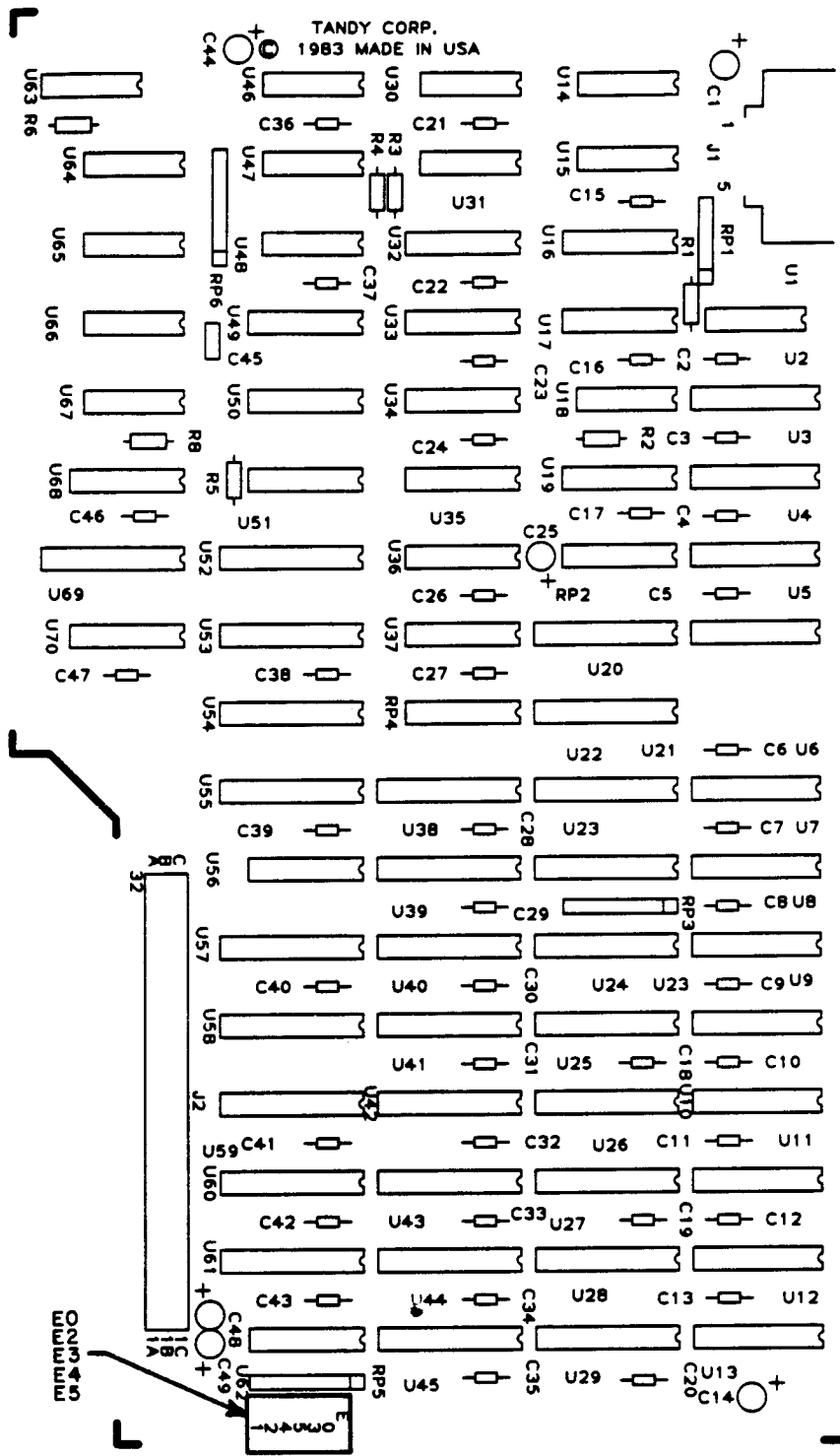

Figure 62. Tandy 2000 Color Graphics Board.

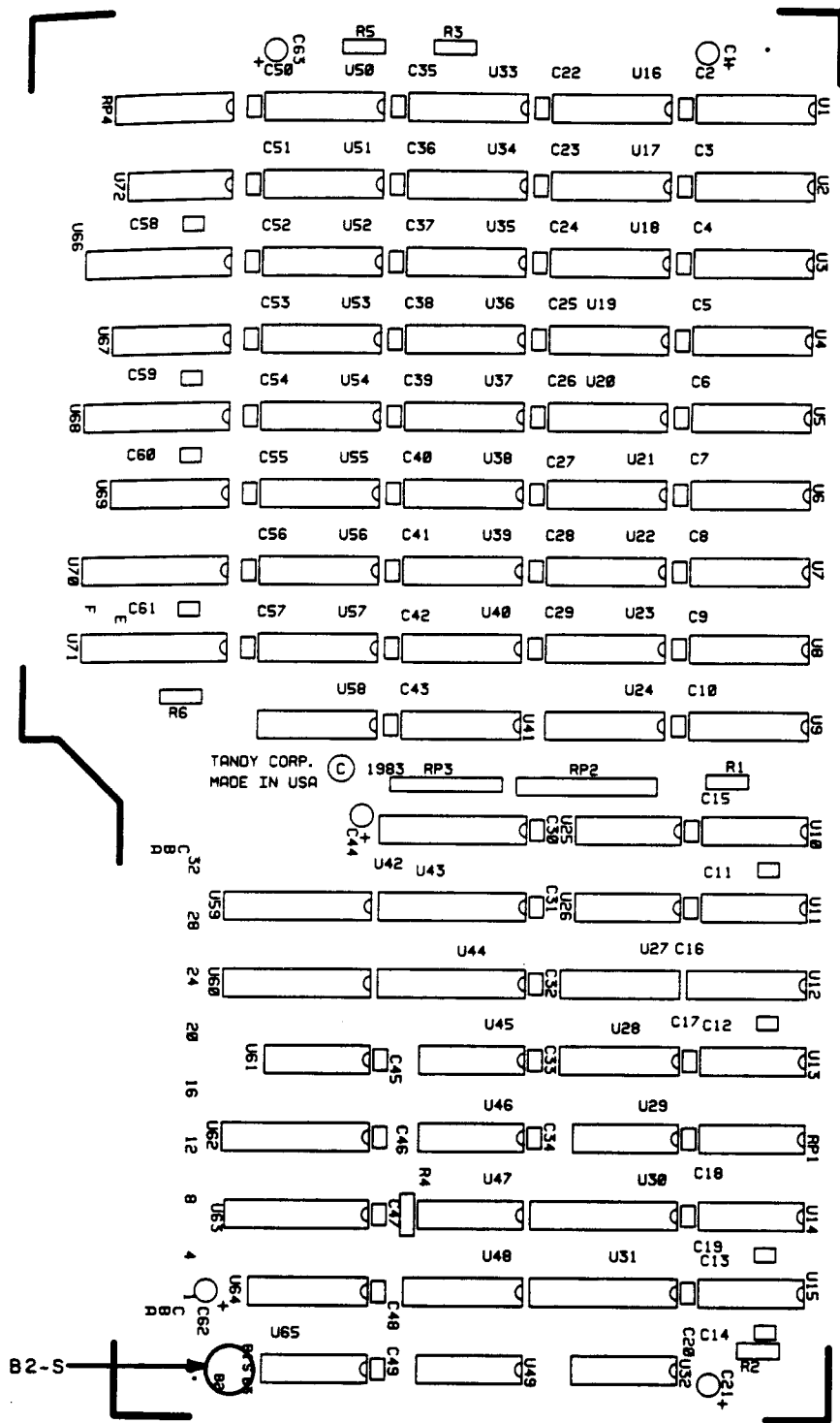

Figure 63. Tandy 2000 First External RAM Board.

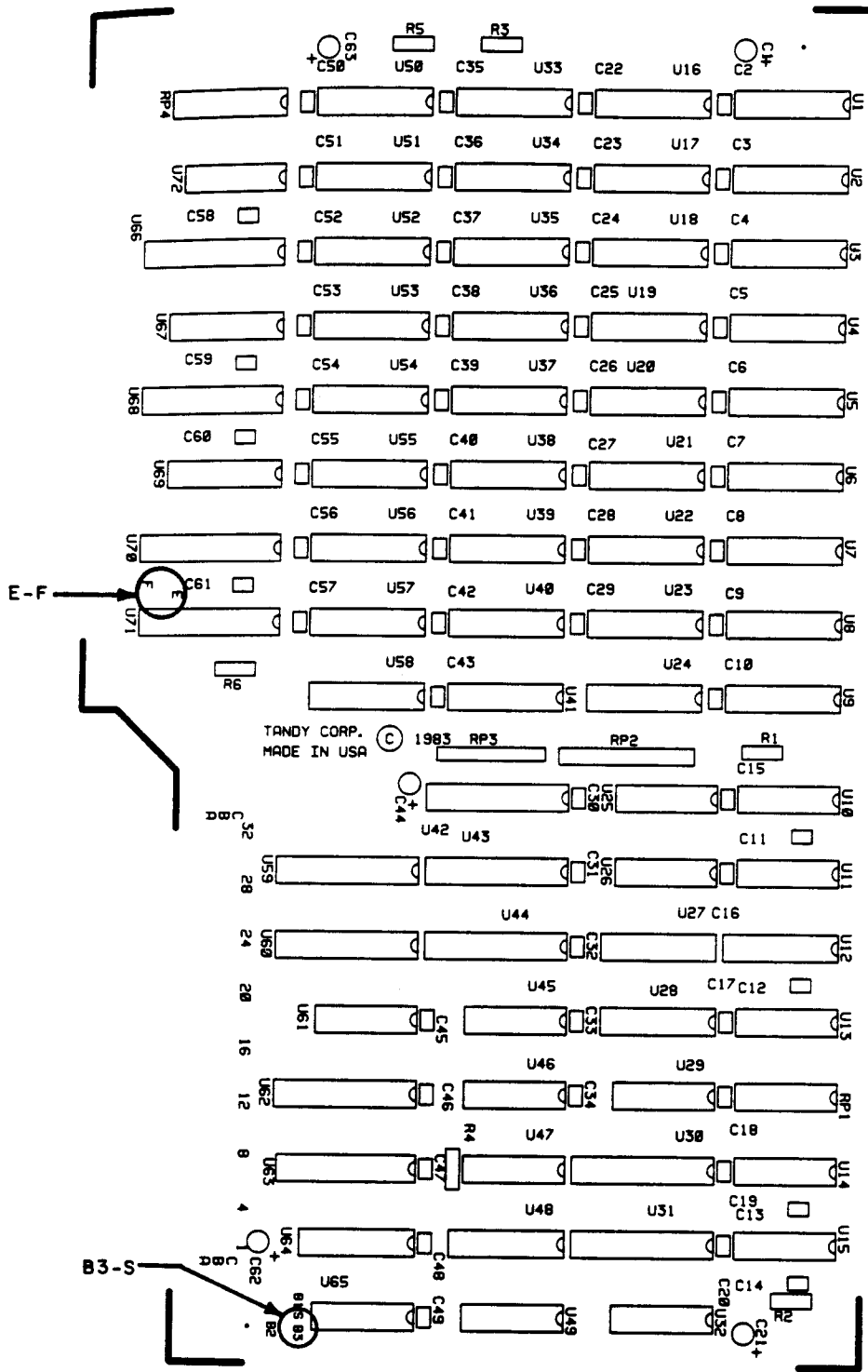

Figure 64. Tandy 2000 Second External RAM Board.

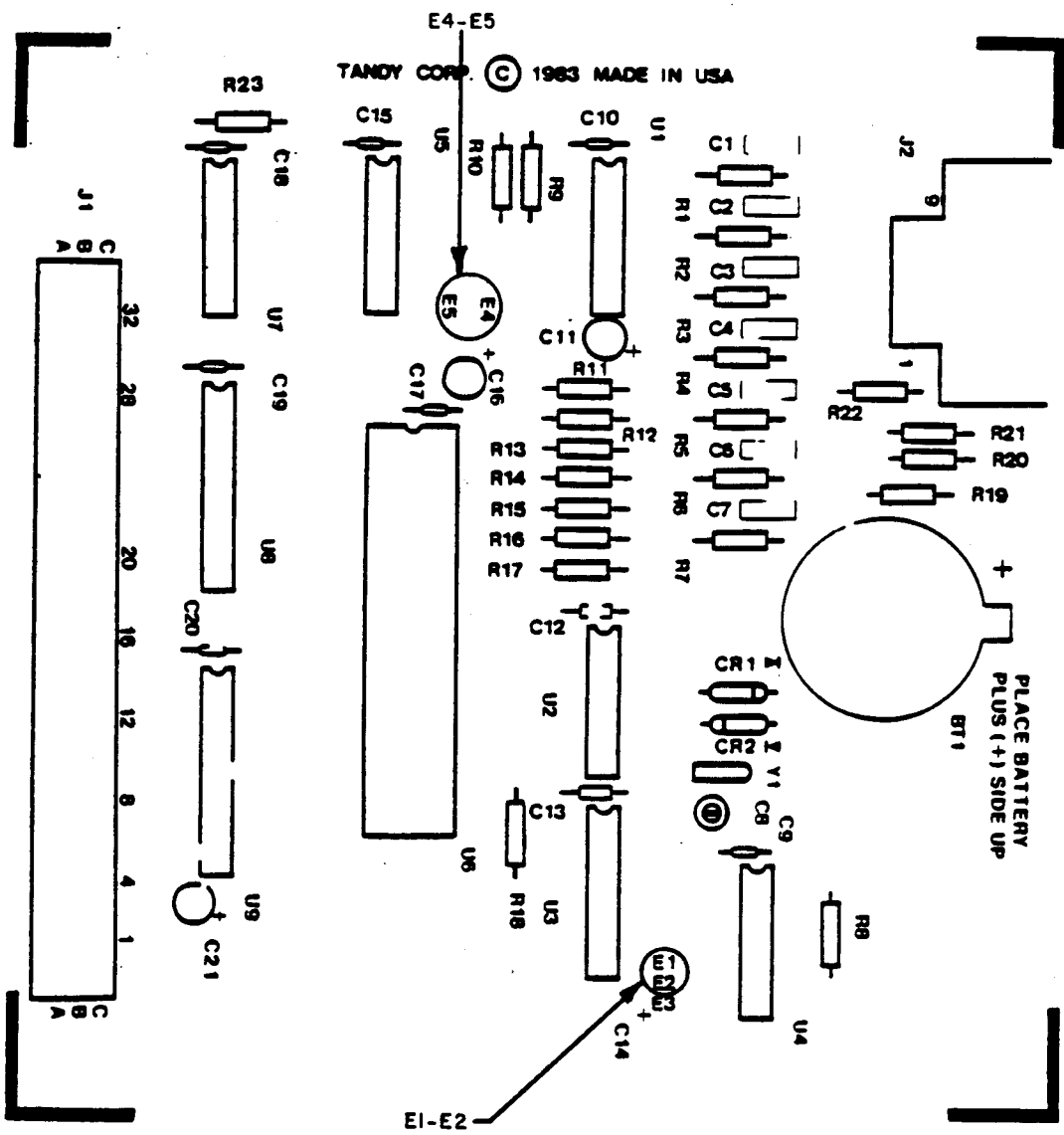

Figure 65. Tandy 2000 Mouse/Clock Board.

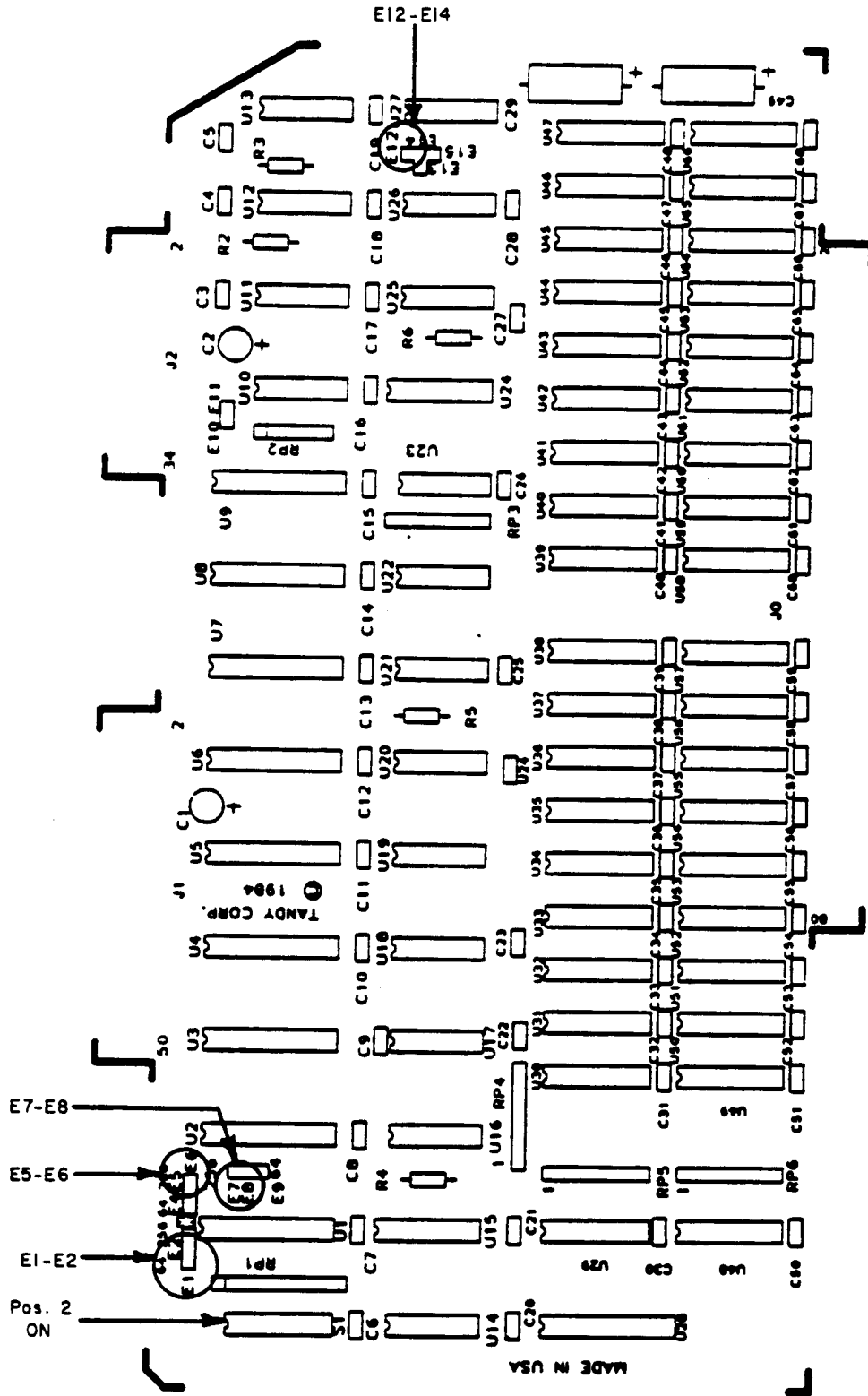

Figure 67. 512K/1MEG 68000 RAM Board with 512K

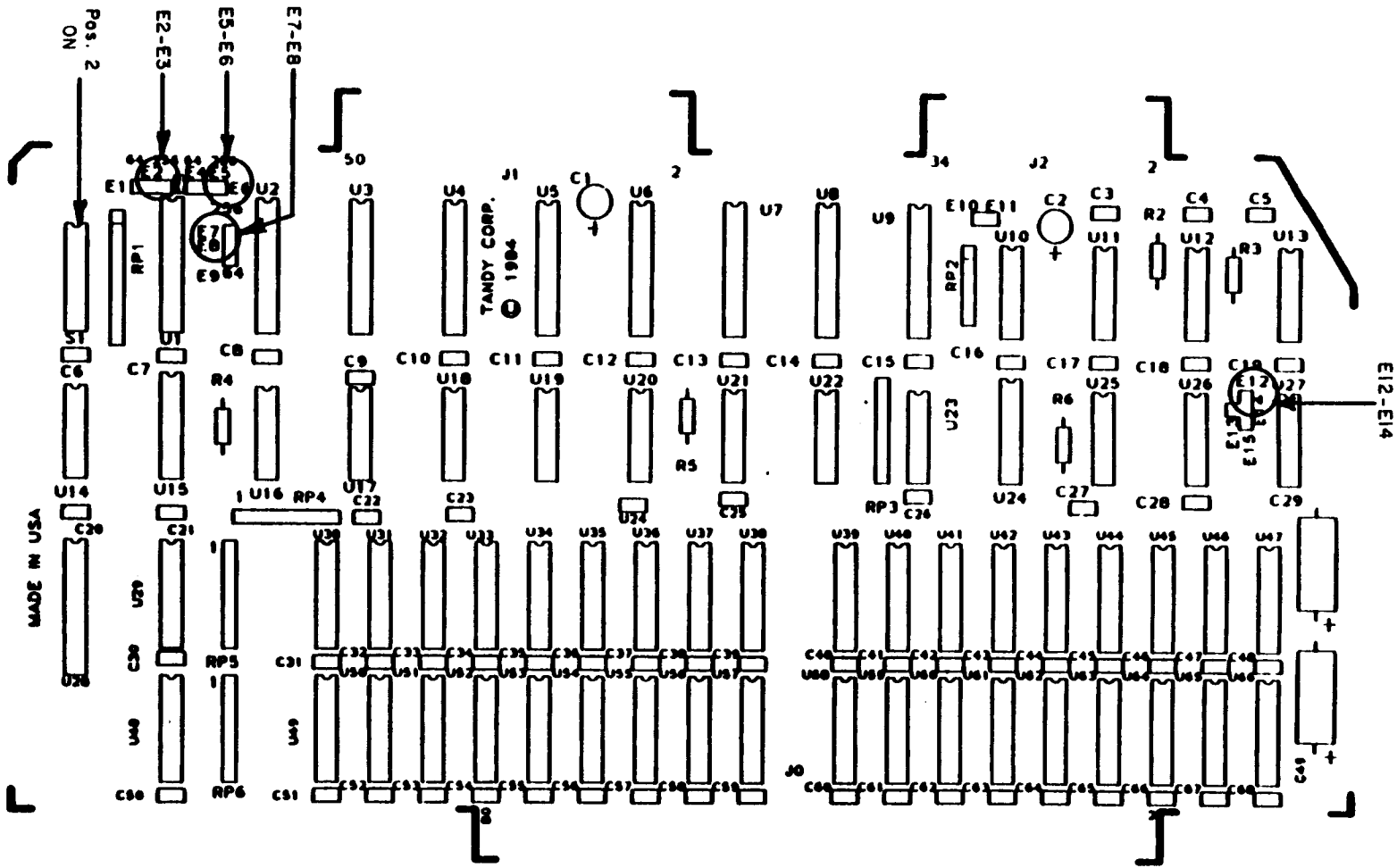

Figure 68. 512K/1MEG 68000 RAM Board with 1MEG

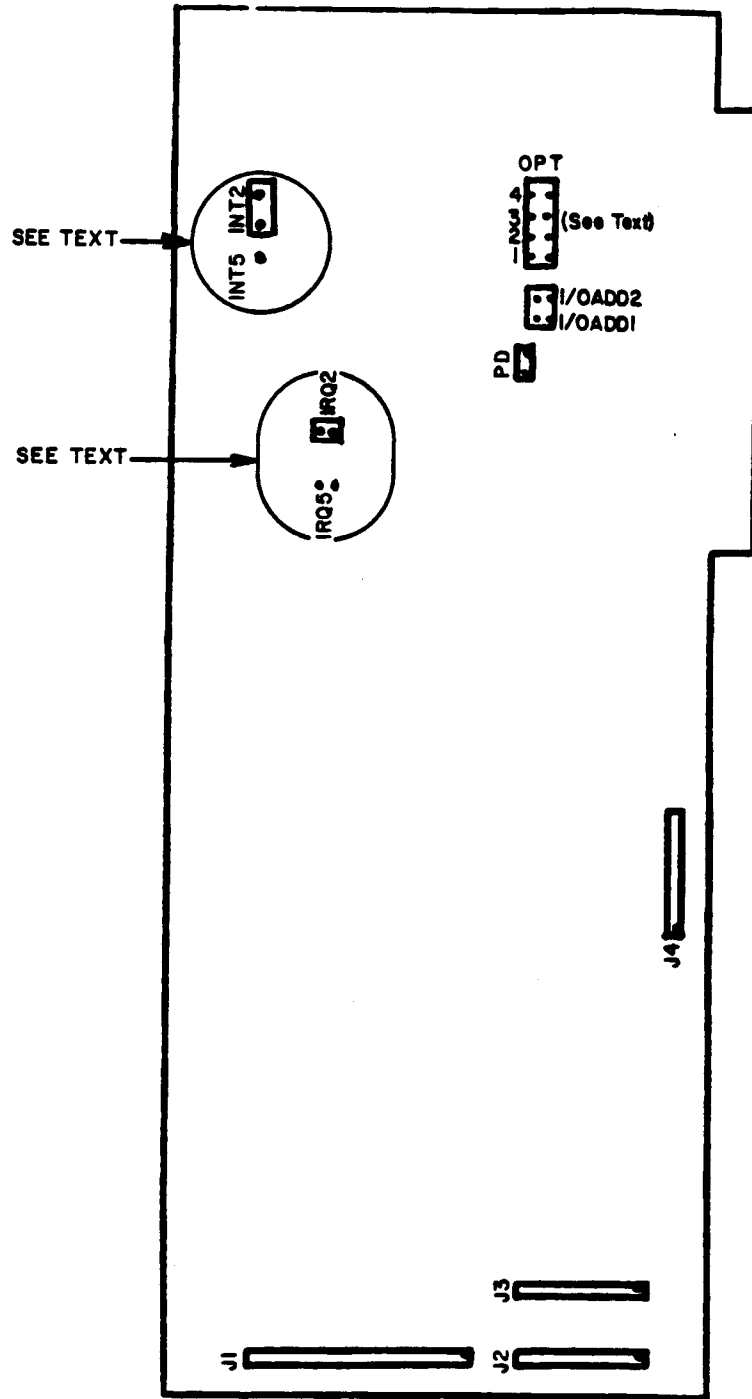

Figure 69. Xebec Hard Drive Controller Board for Tandy 1000/1200.

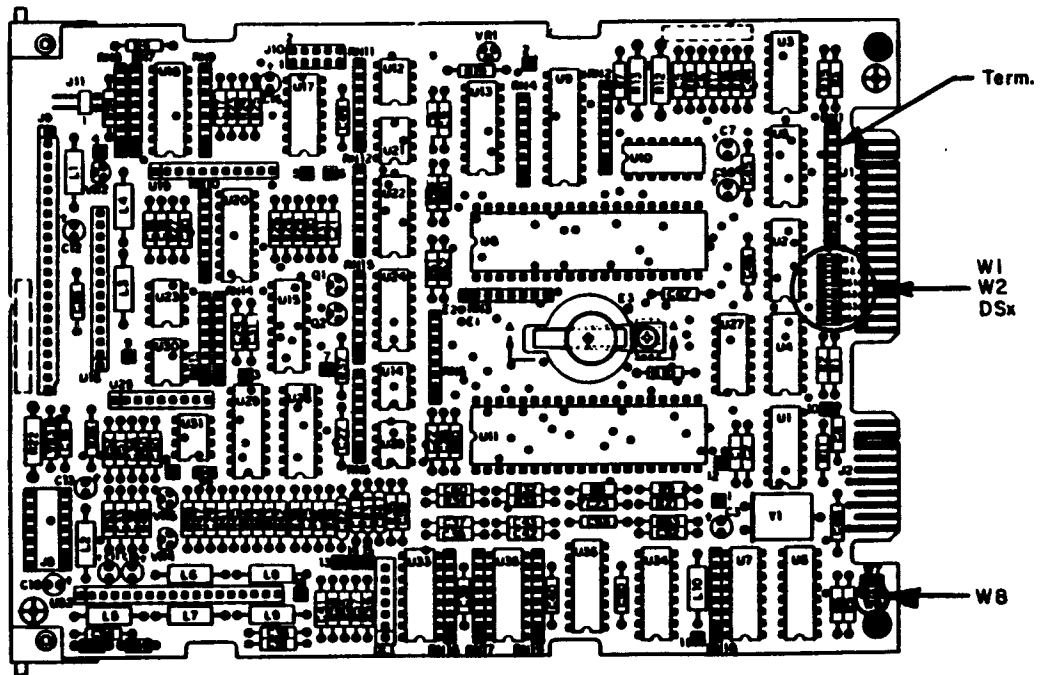

Figure 70. 70 MEG Hard Drive Logic Board

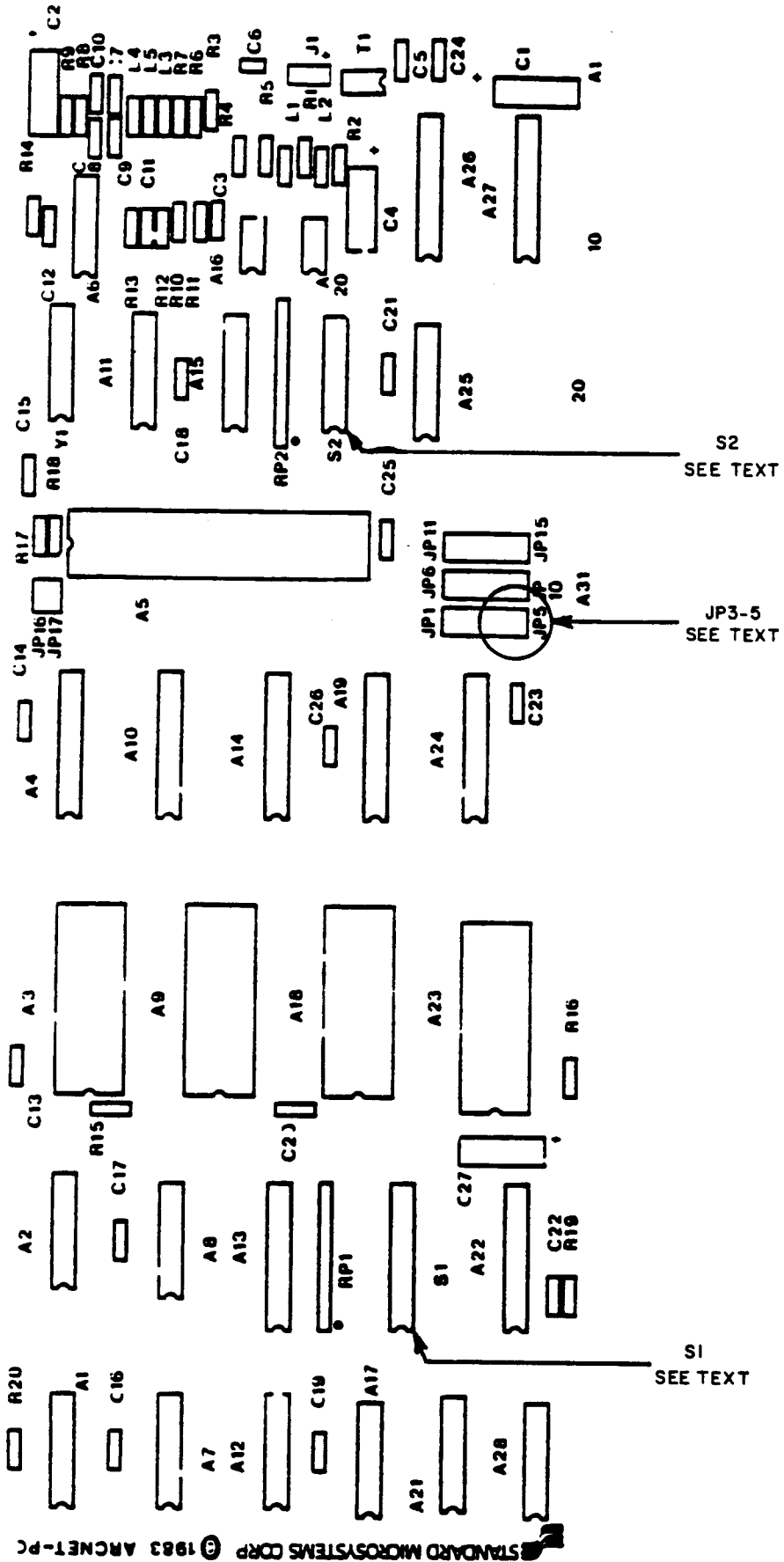

Figure 71. Vianet Board for Tandy 1000/1200

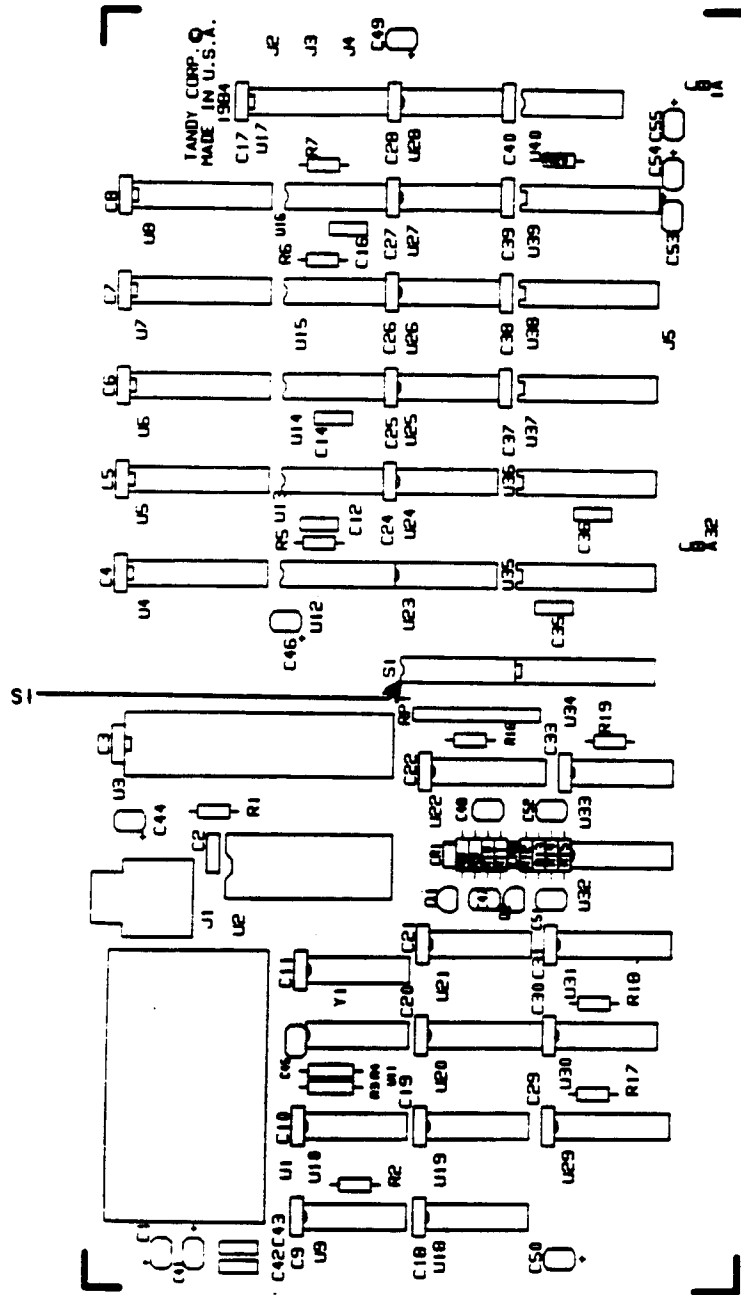

Figure 72. Vianet Board for Tandy 2000

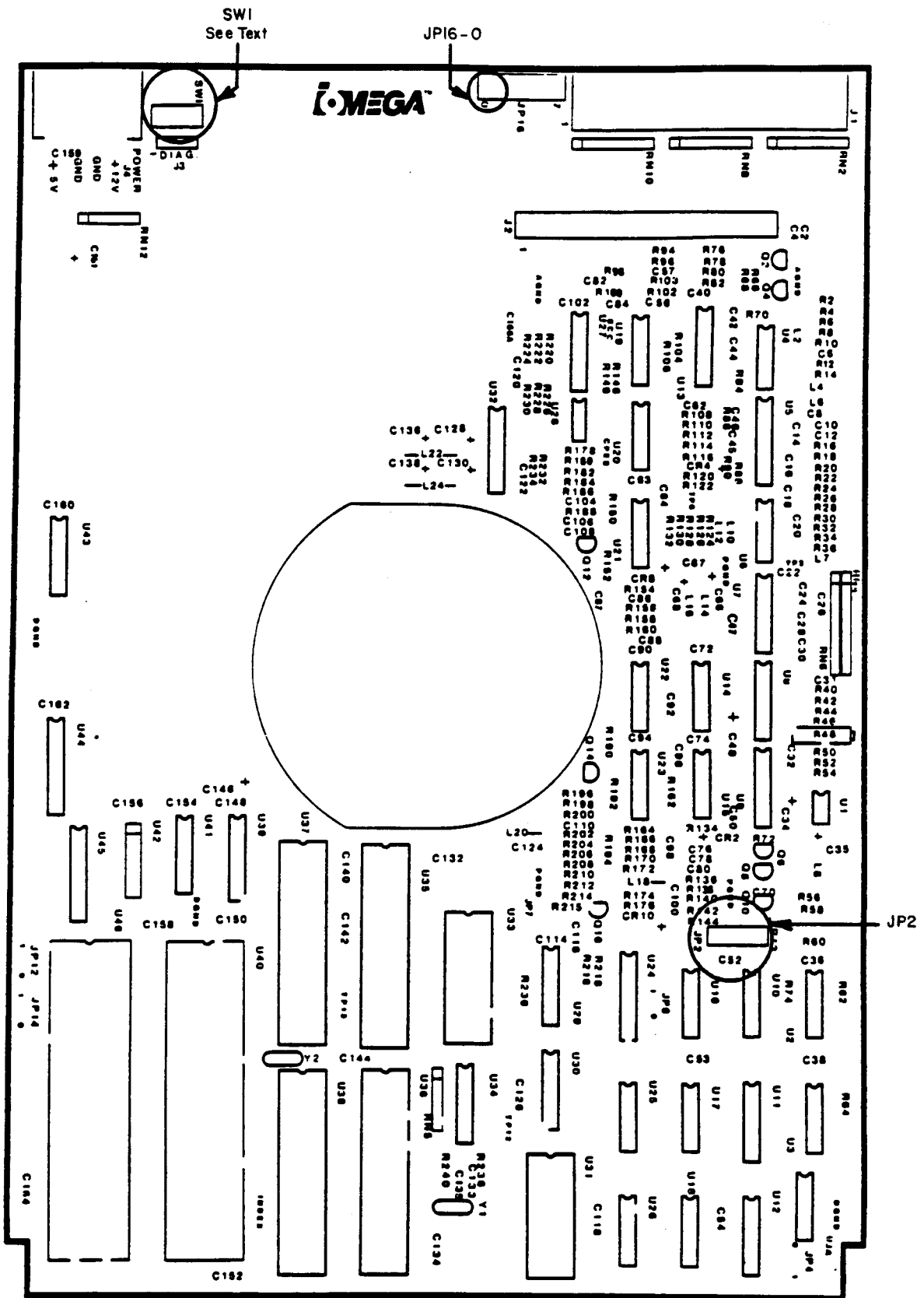

Figure 73. Disk Cartridge Controller Board

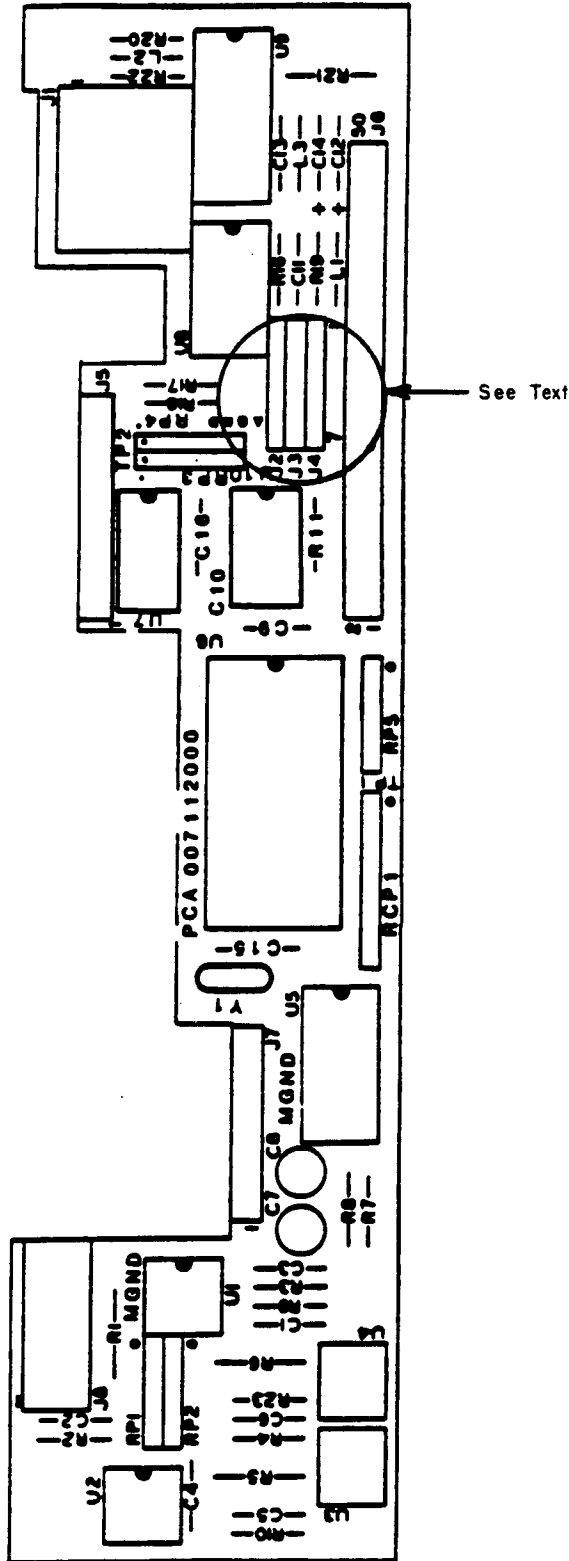

Figure 74. Disk Cartridge Drive Logic Board

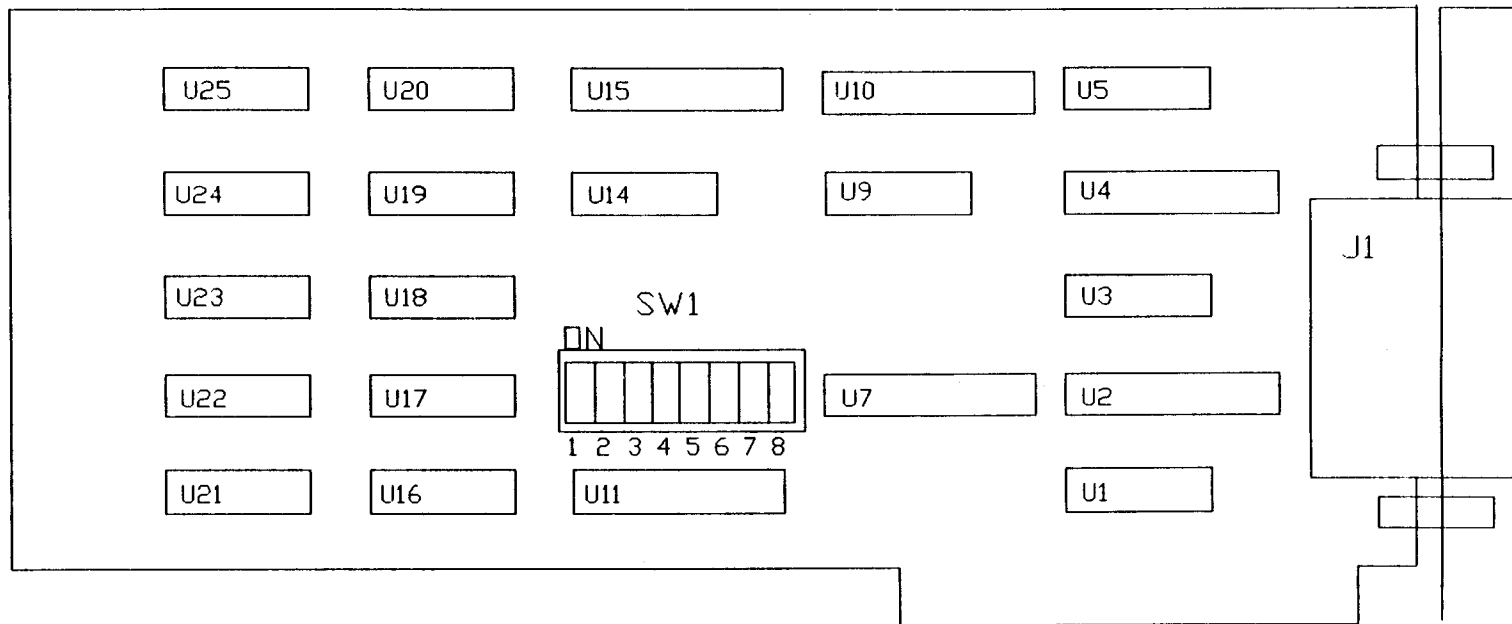

Figure 75. Tandy 1000/1200 Interface Board for the 8" Disk Cartridge

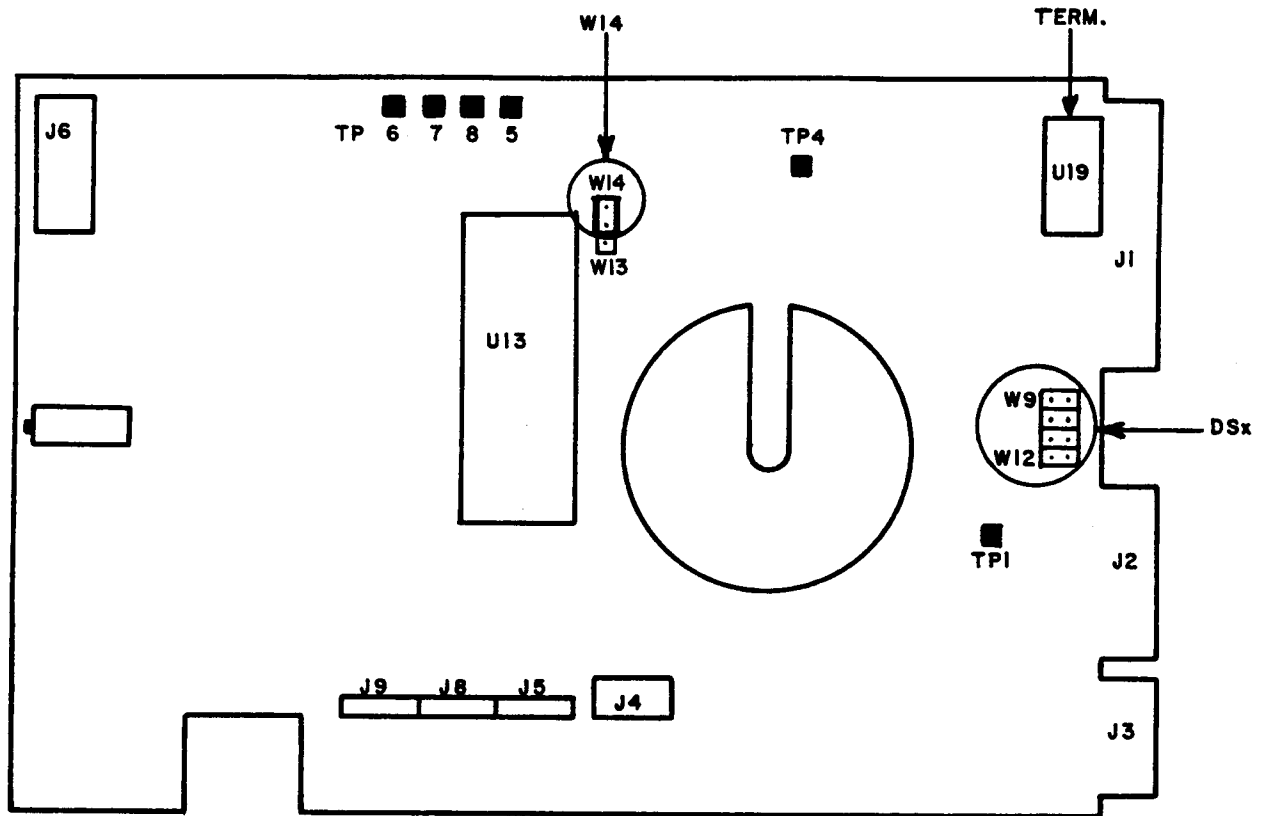

Figure 76. 10 MEG Thinline (TM-252) Hard Drive Logic Board.

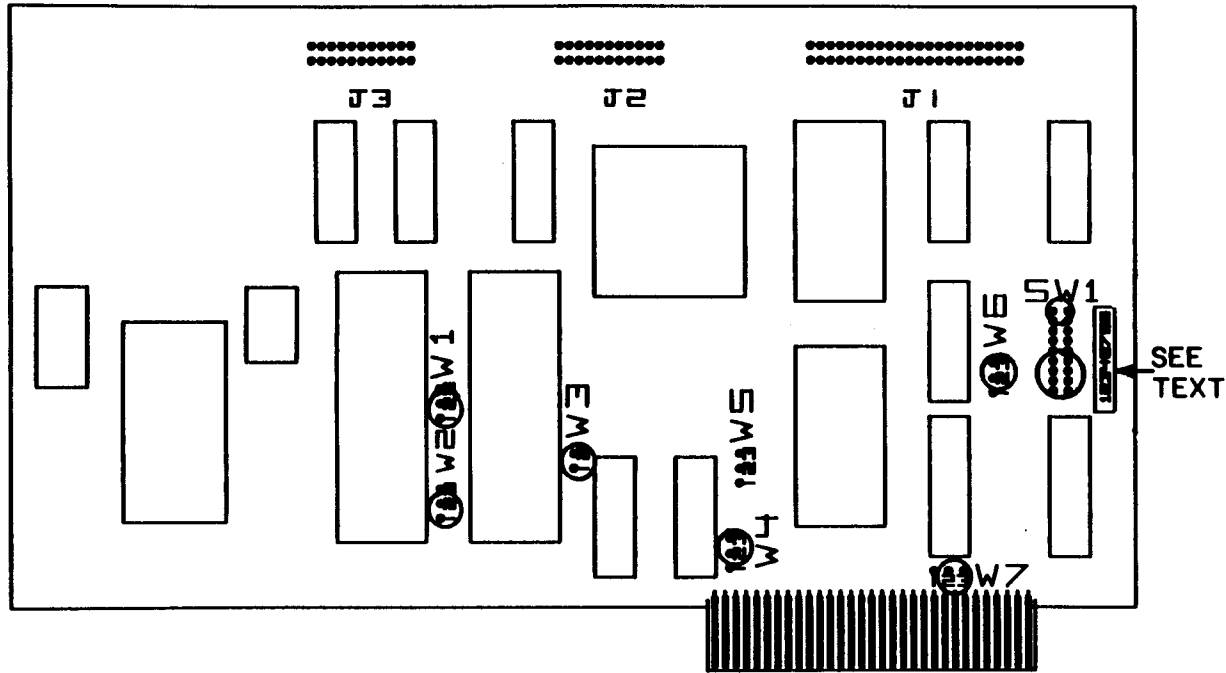

Figure 77. Tandy 1000 WD1010 Hard Drive Controller Board.

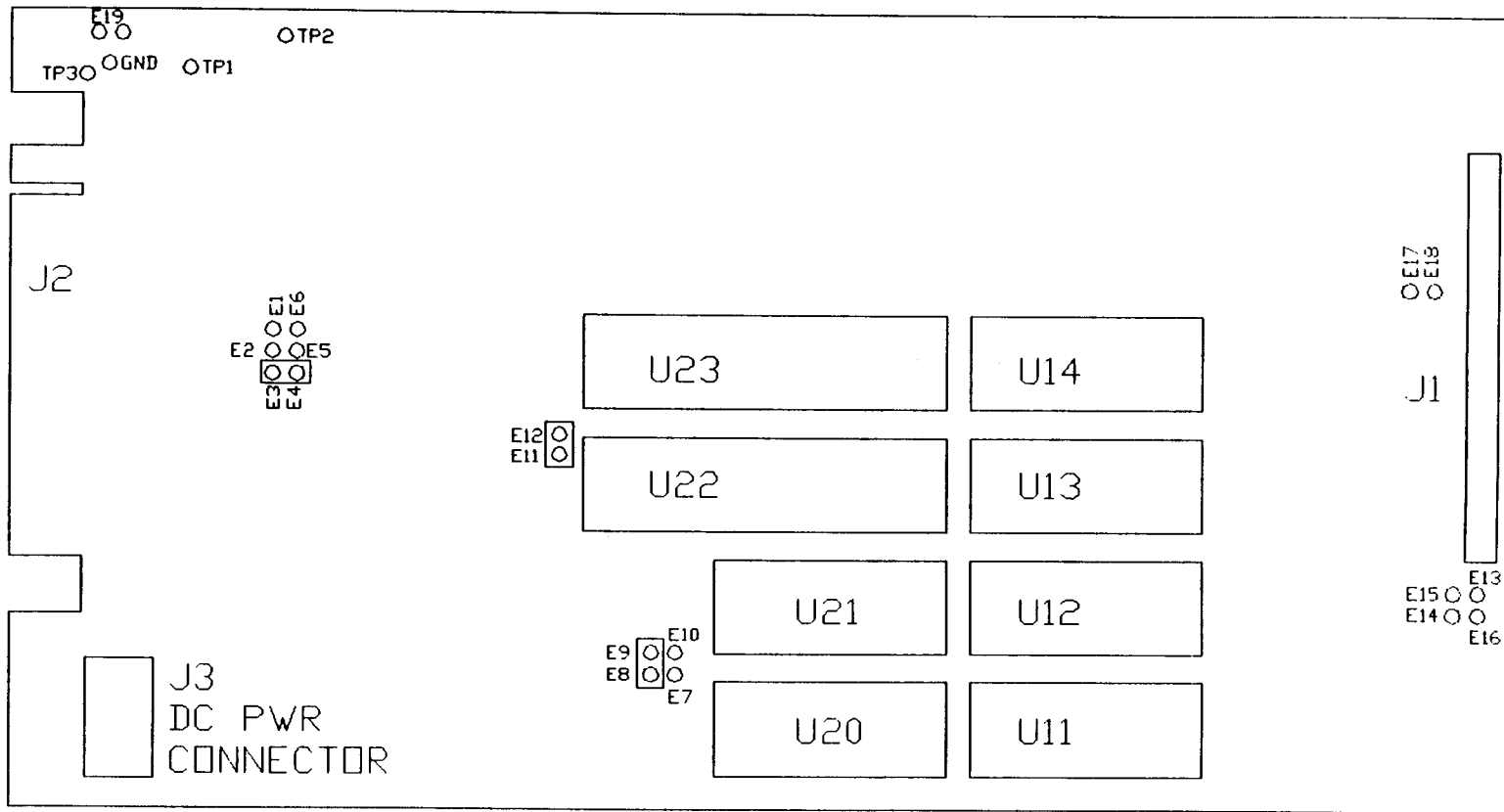

Figure 78. Tape Cartridge Controller Board (TCS-100)

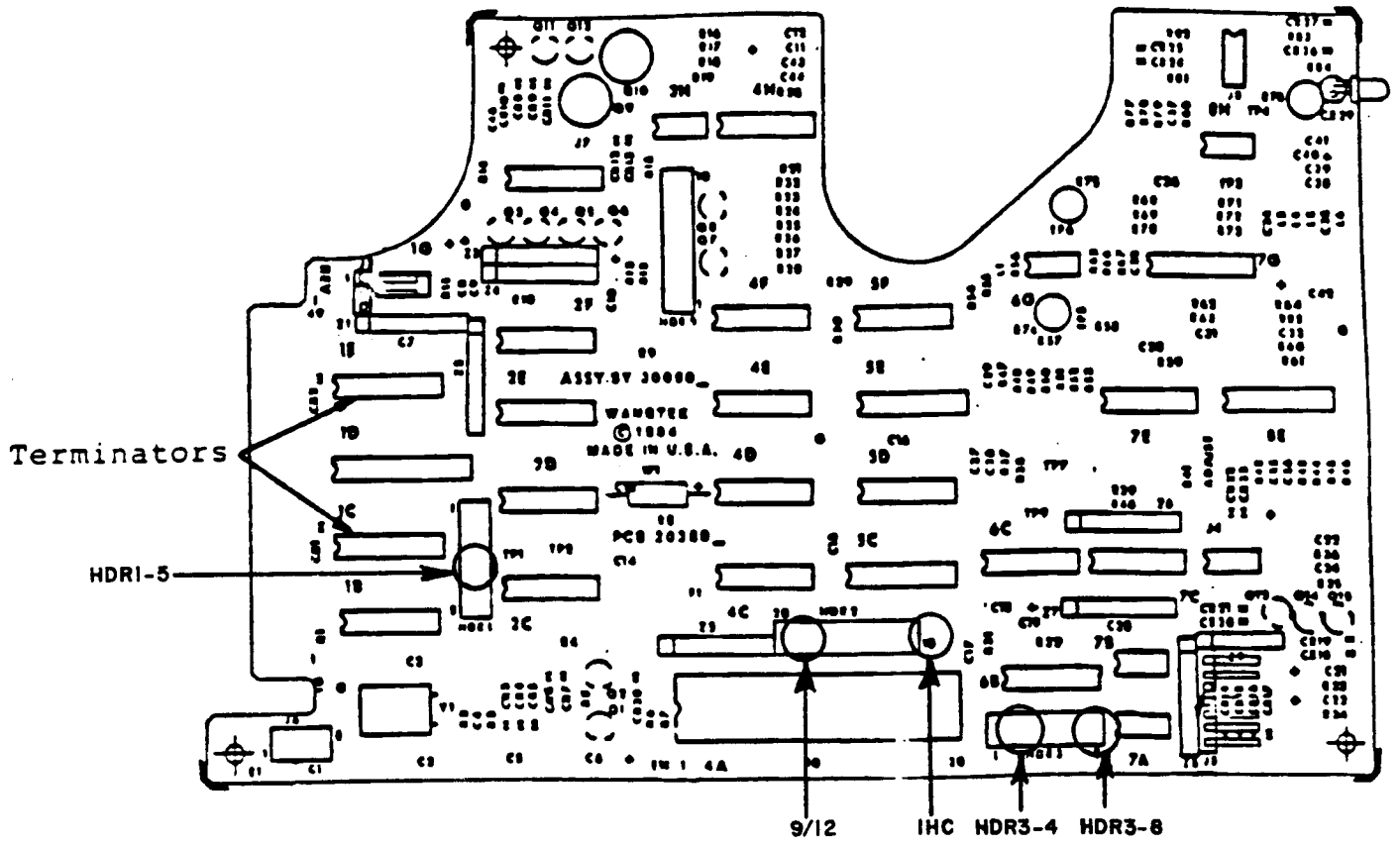

Figure 79. Tape Cartridge Drive Logic Board.

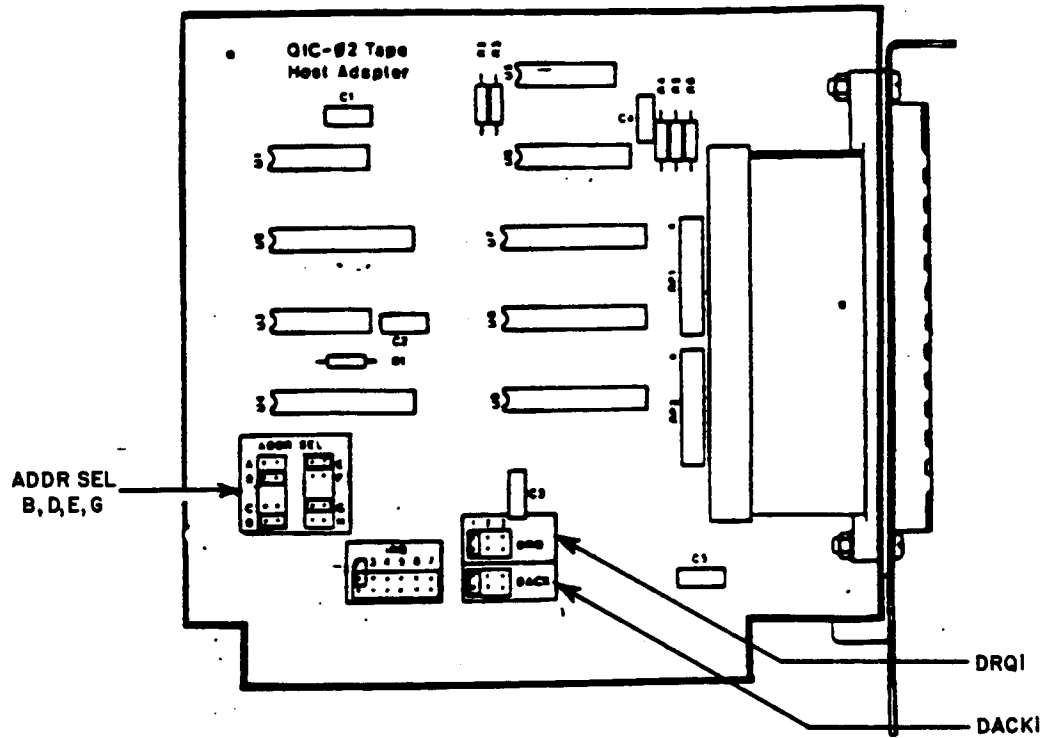
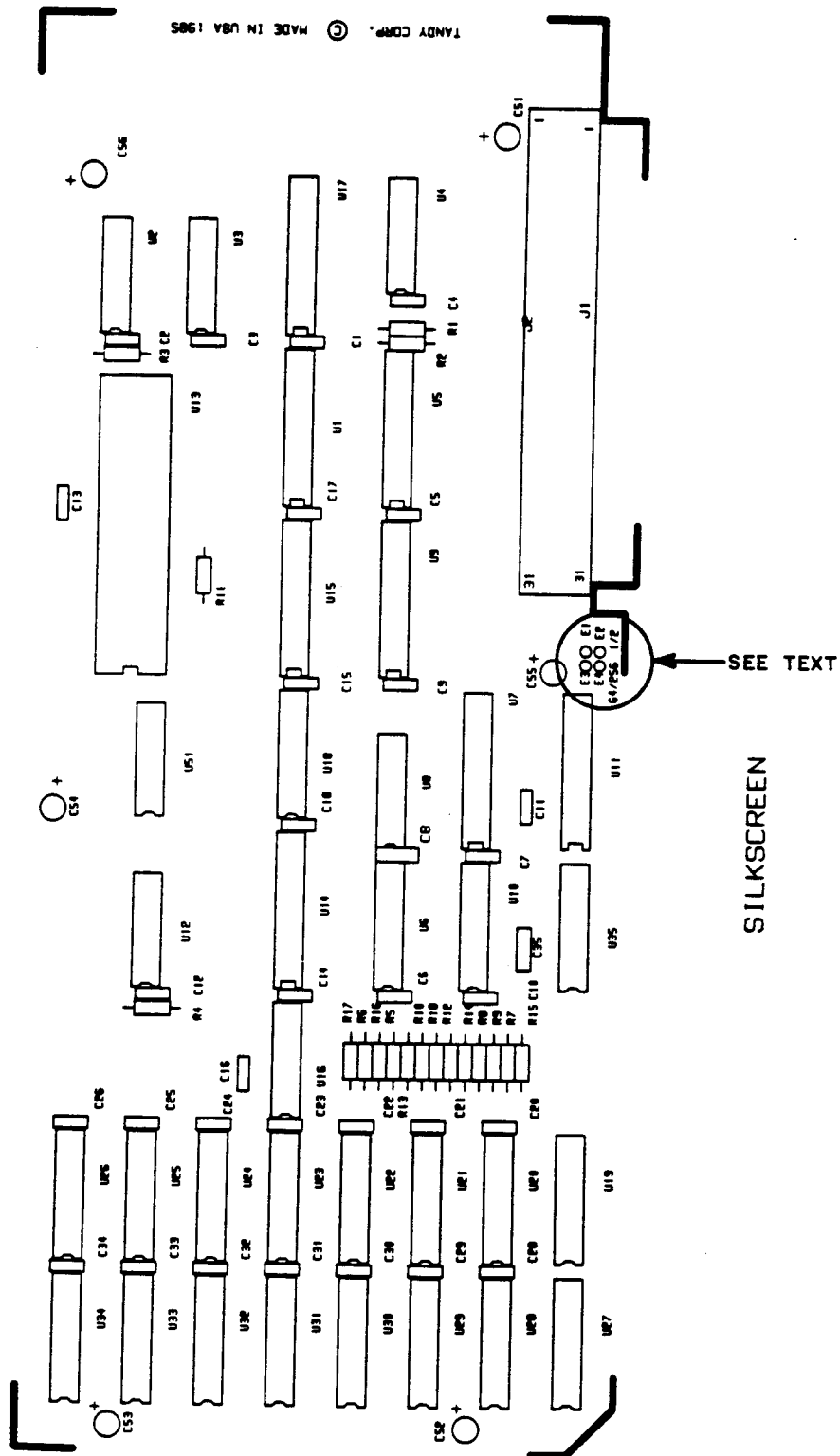

Figure 80. Tape Cartridge Interface Board to the Tandy 1000/1200.



SILKSCREEN

Figure 81. Tandy 1000 Memory Plus Board.

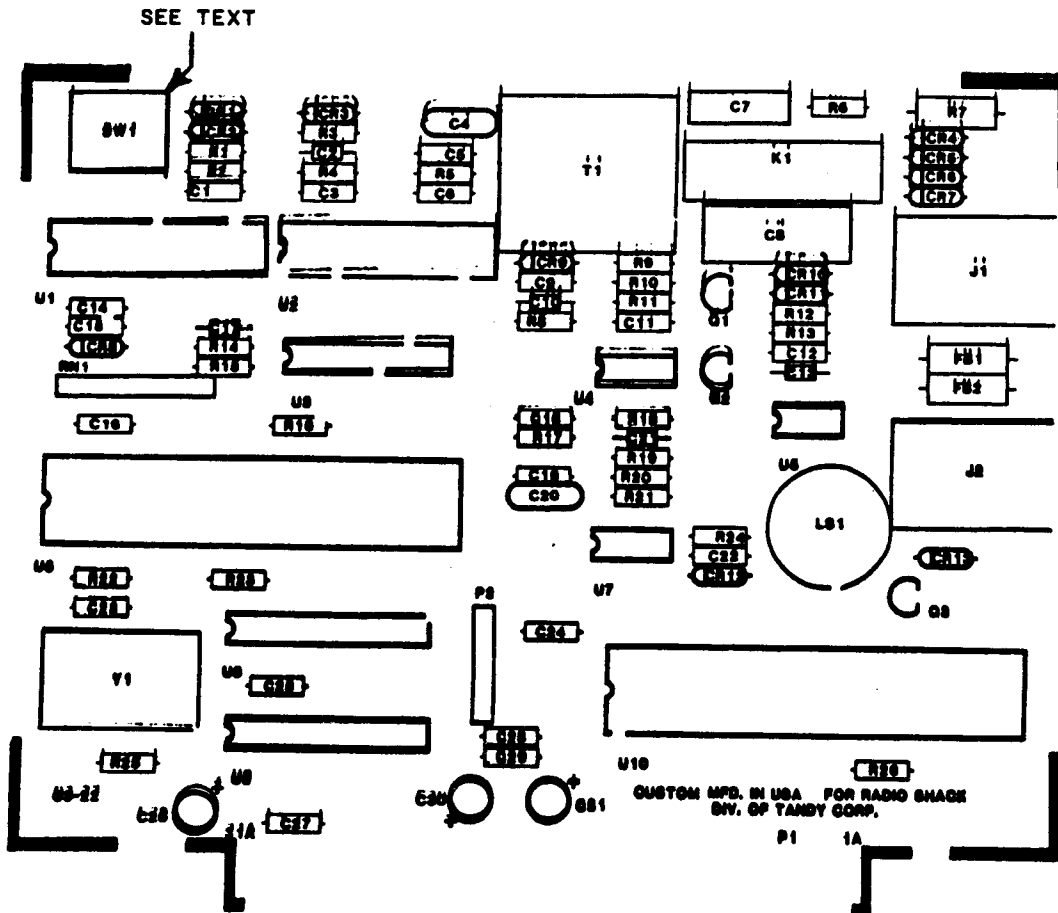
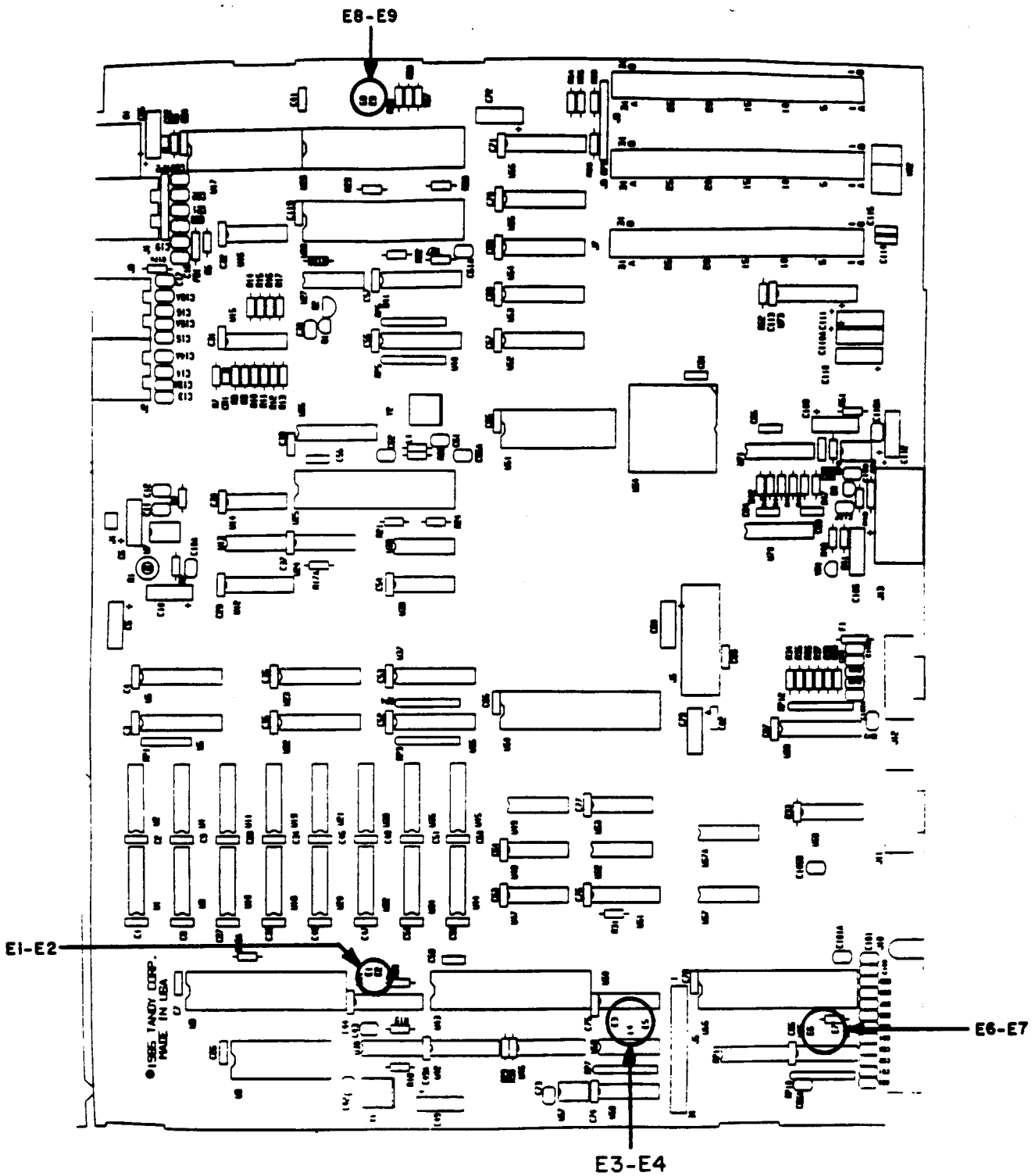

Figure 82. Tandy 1000 Internal 1200 Baud Modem.



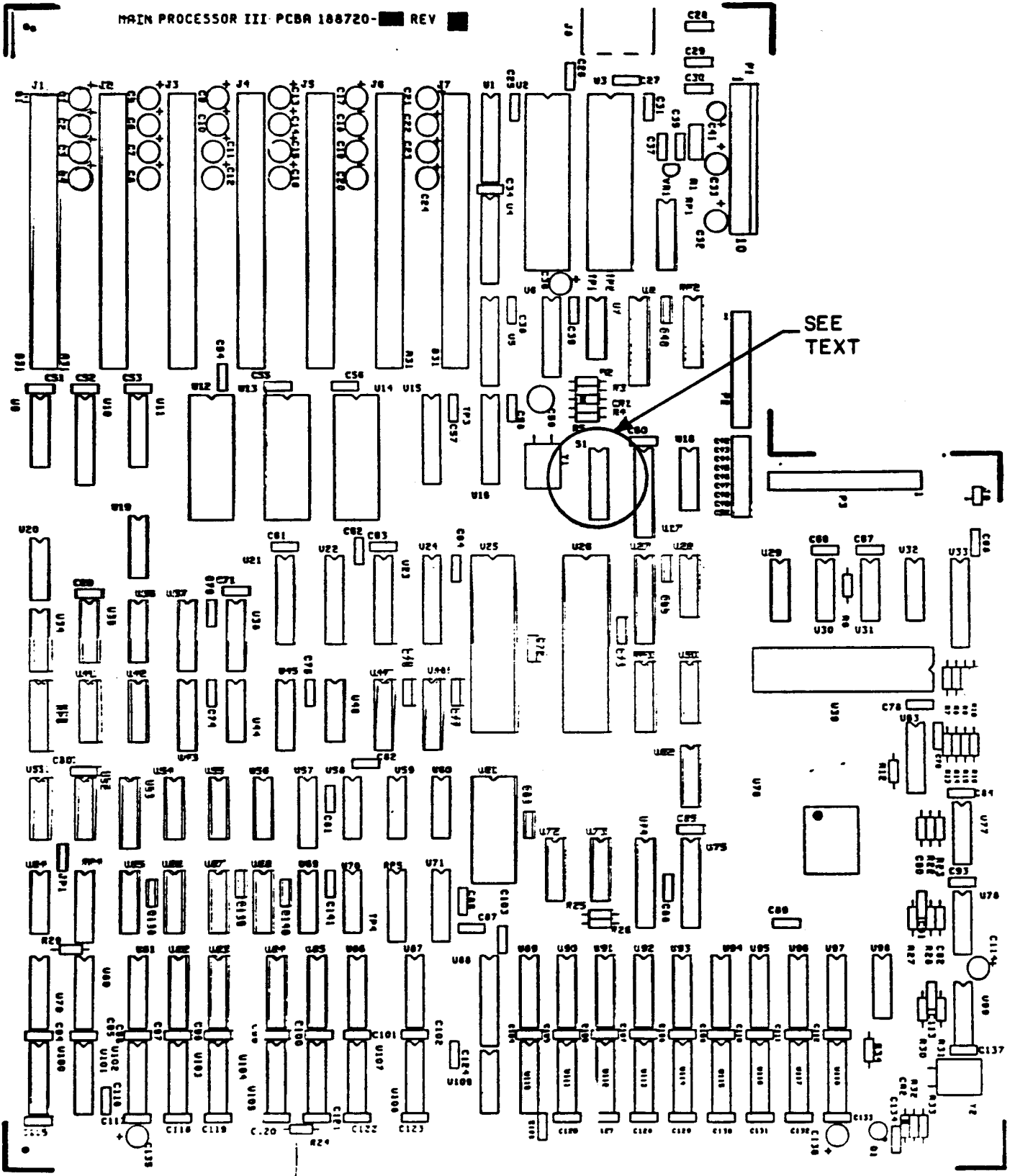

Figure 84. Tandy 1200A Main Logic Board.

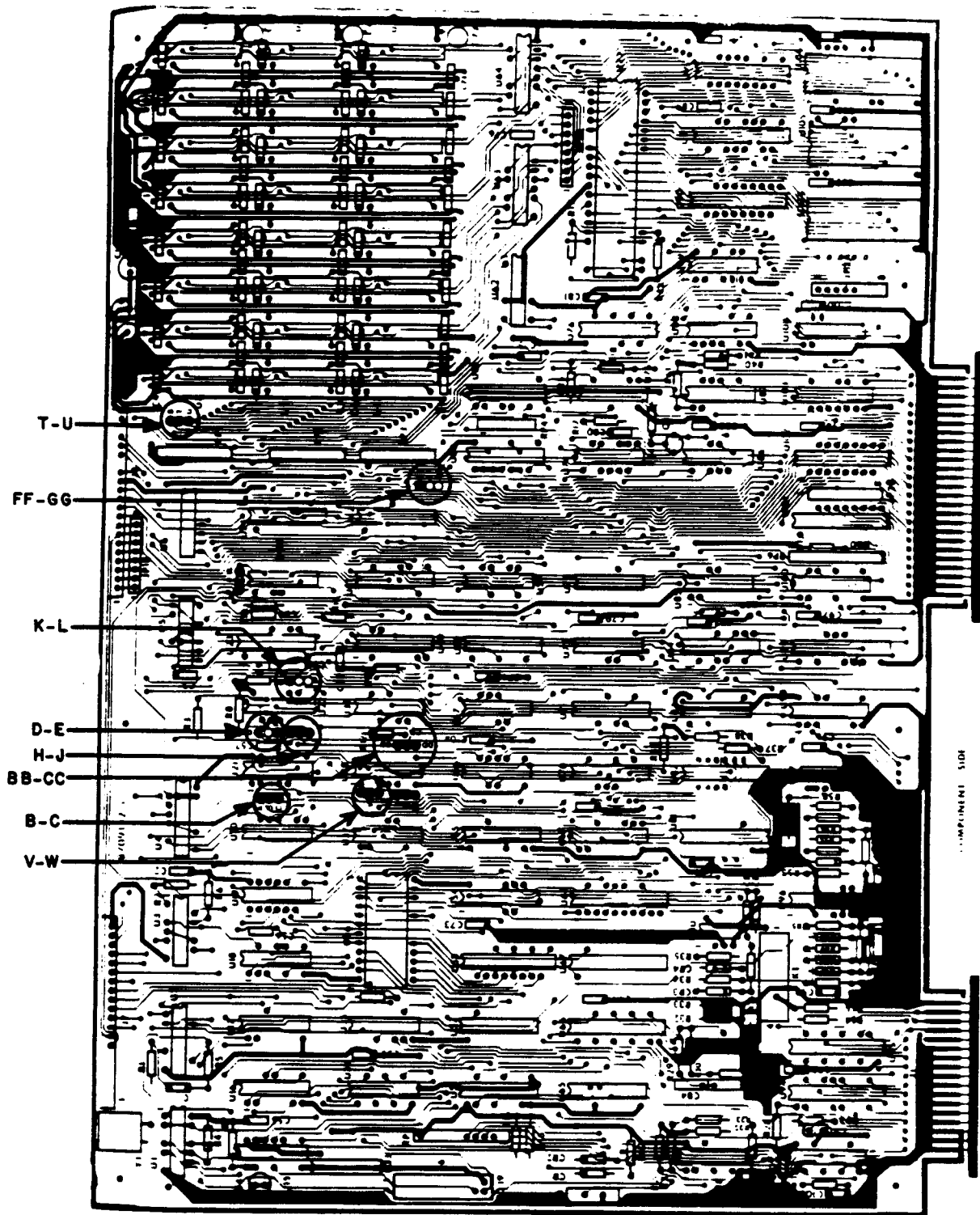

Figure 85. 4K Model III Main Logic Board.

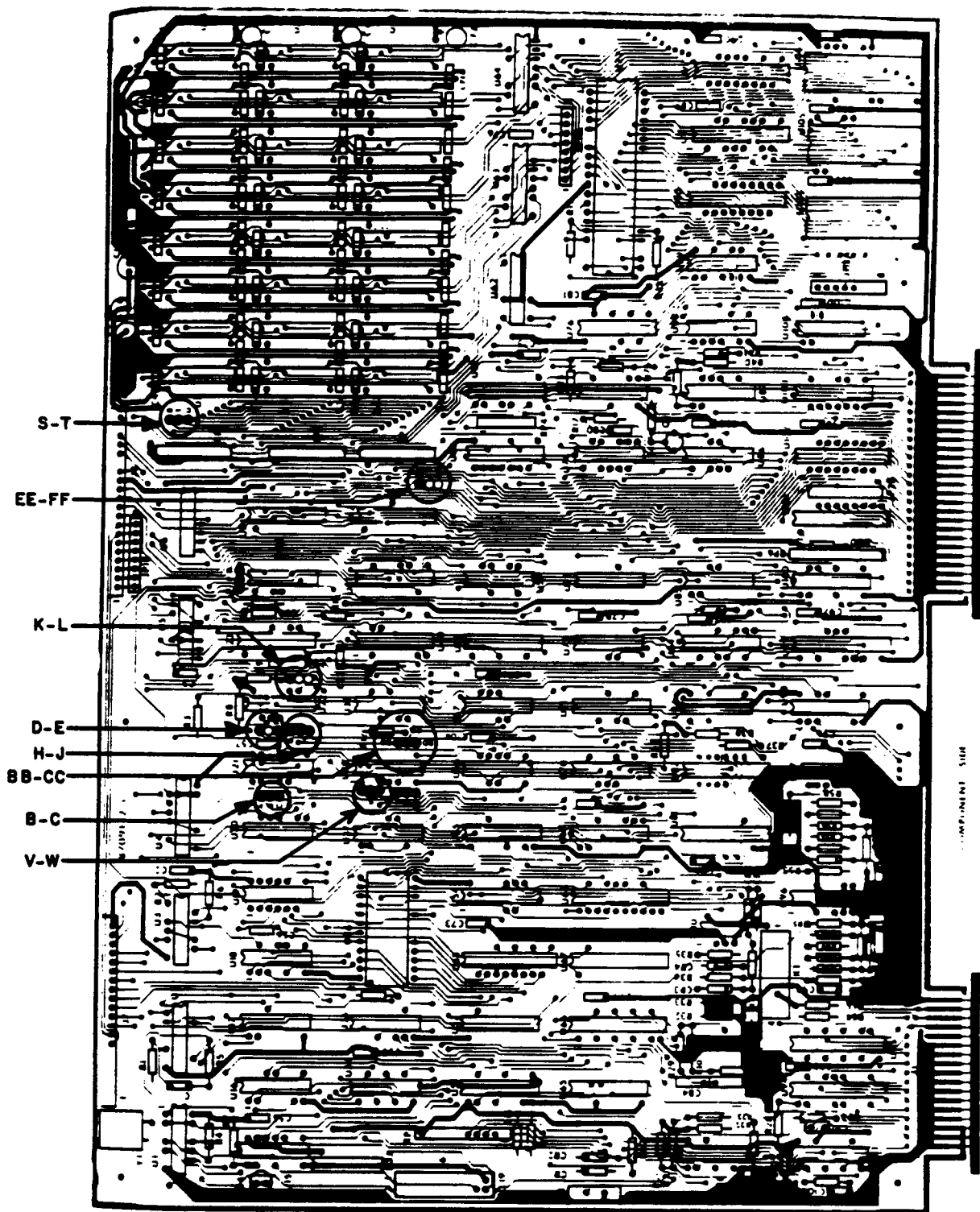

Figure 86. 16K/32K/48K Model III Main Logic Board.

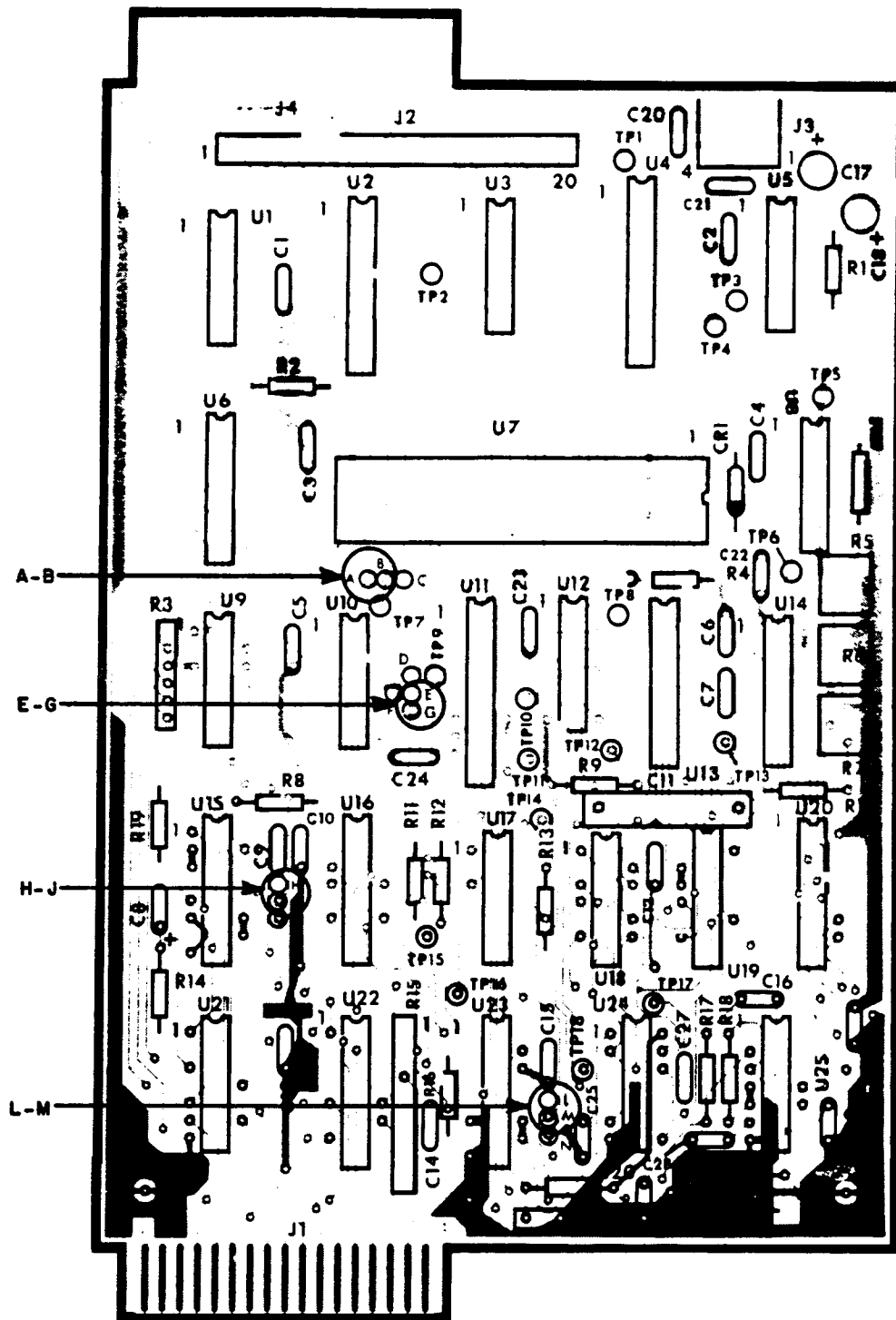

Figure 87. Model III/4 Early FDC Board.

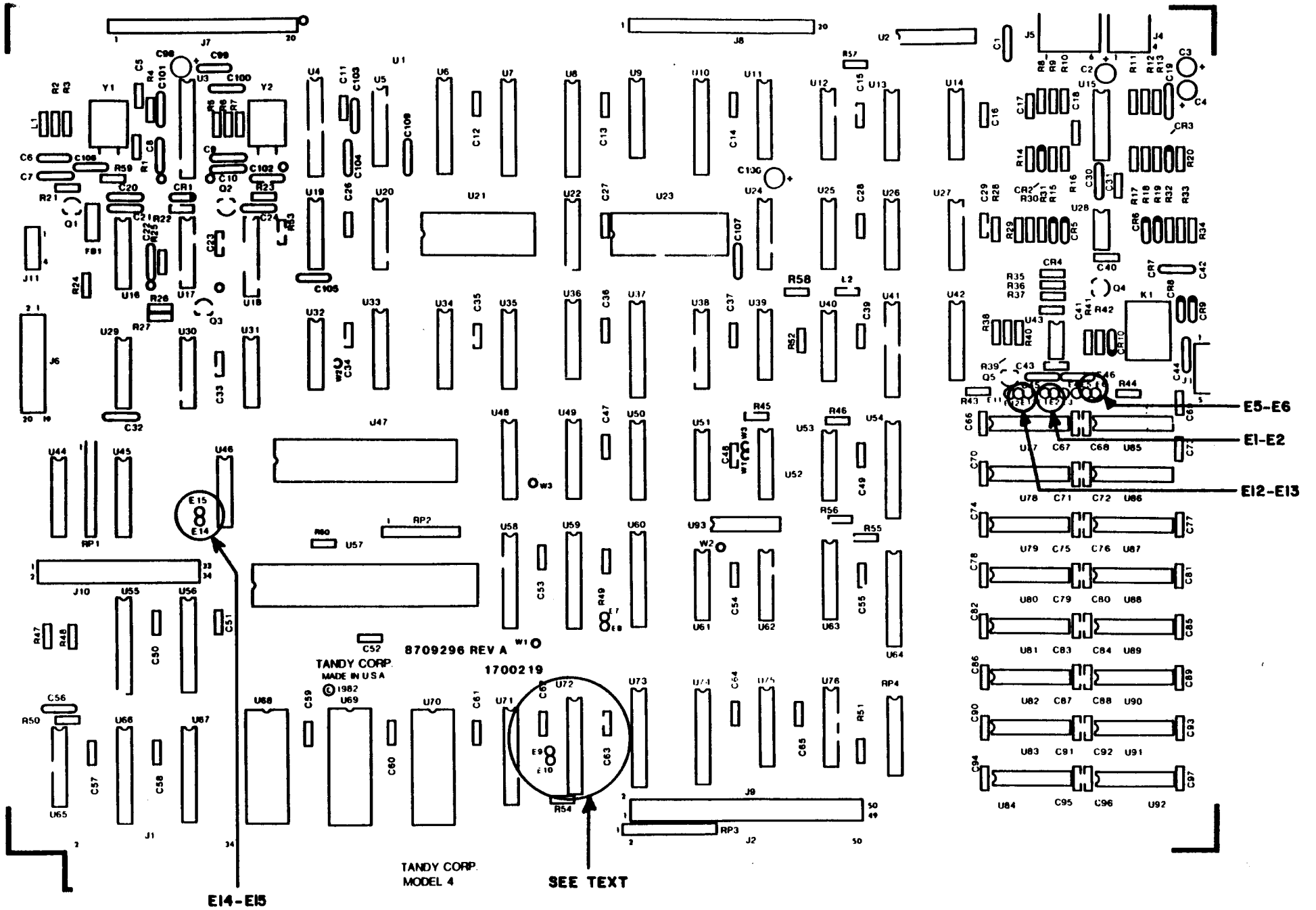

Figure 88. 16K Model 4 Standard PCB

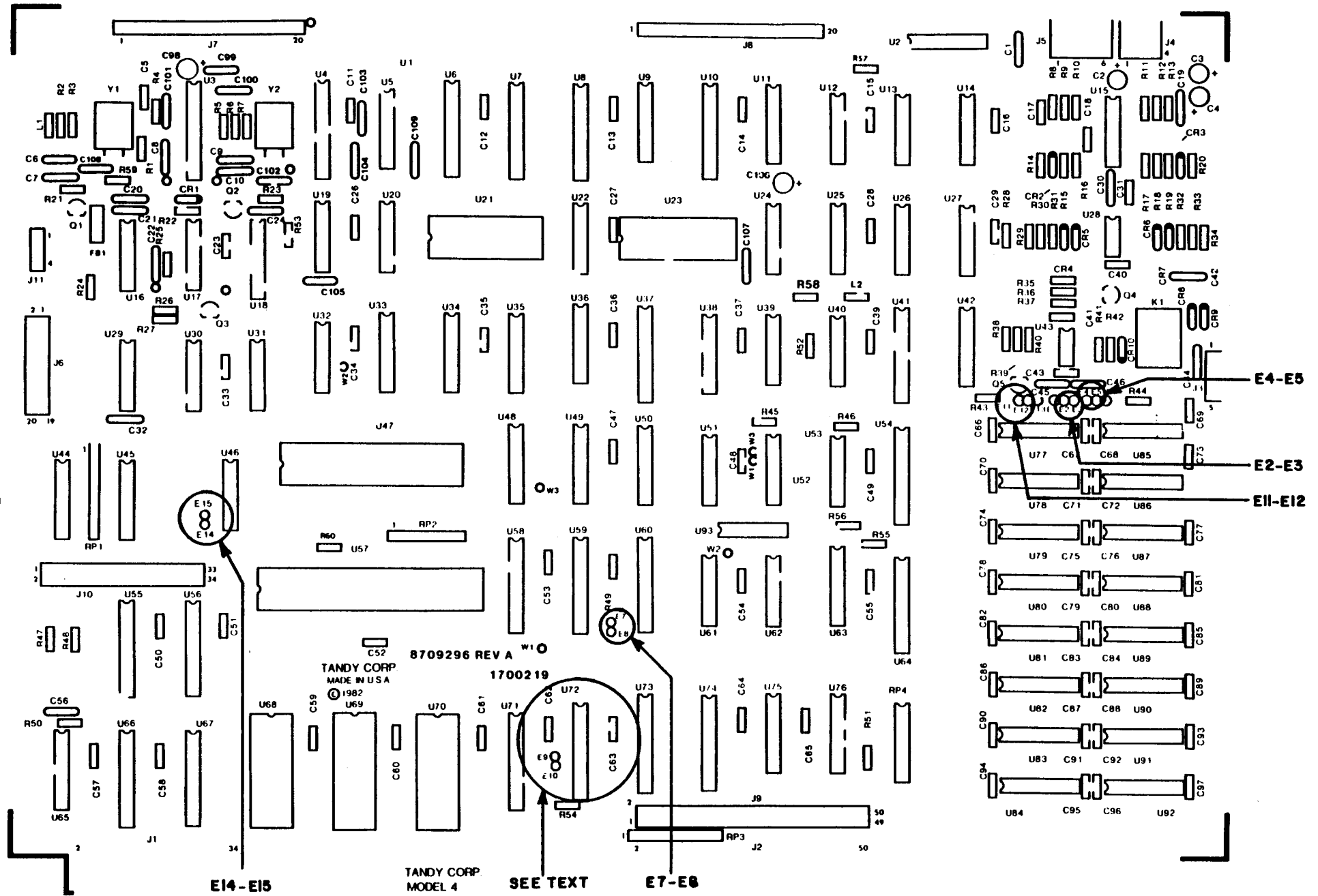

Figure 89. 64K/128K Model 4 Standard PCB.

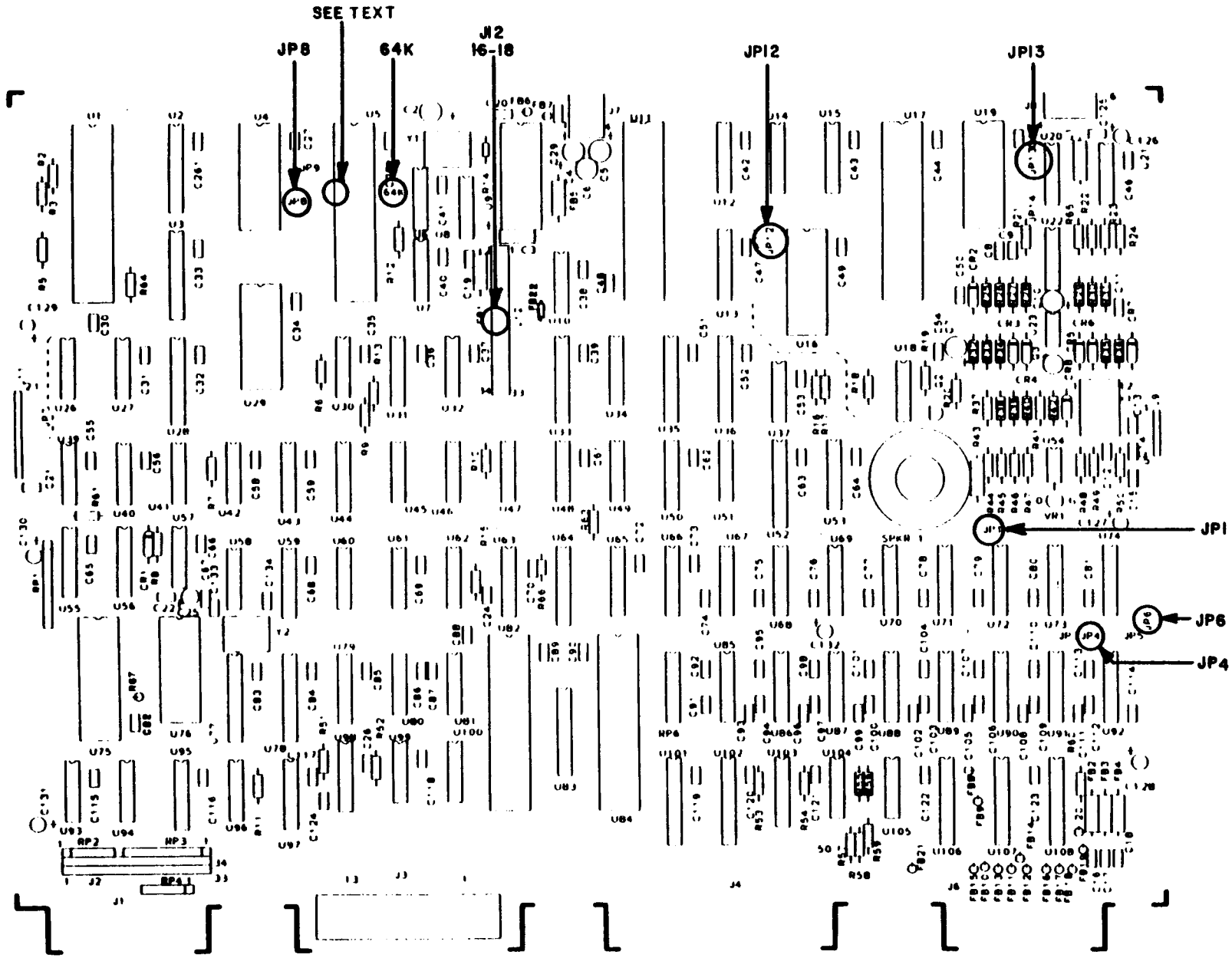

Figure 90. 64K/128K Model 4 Gate Array PCB

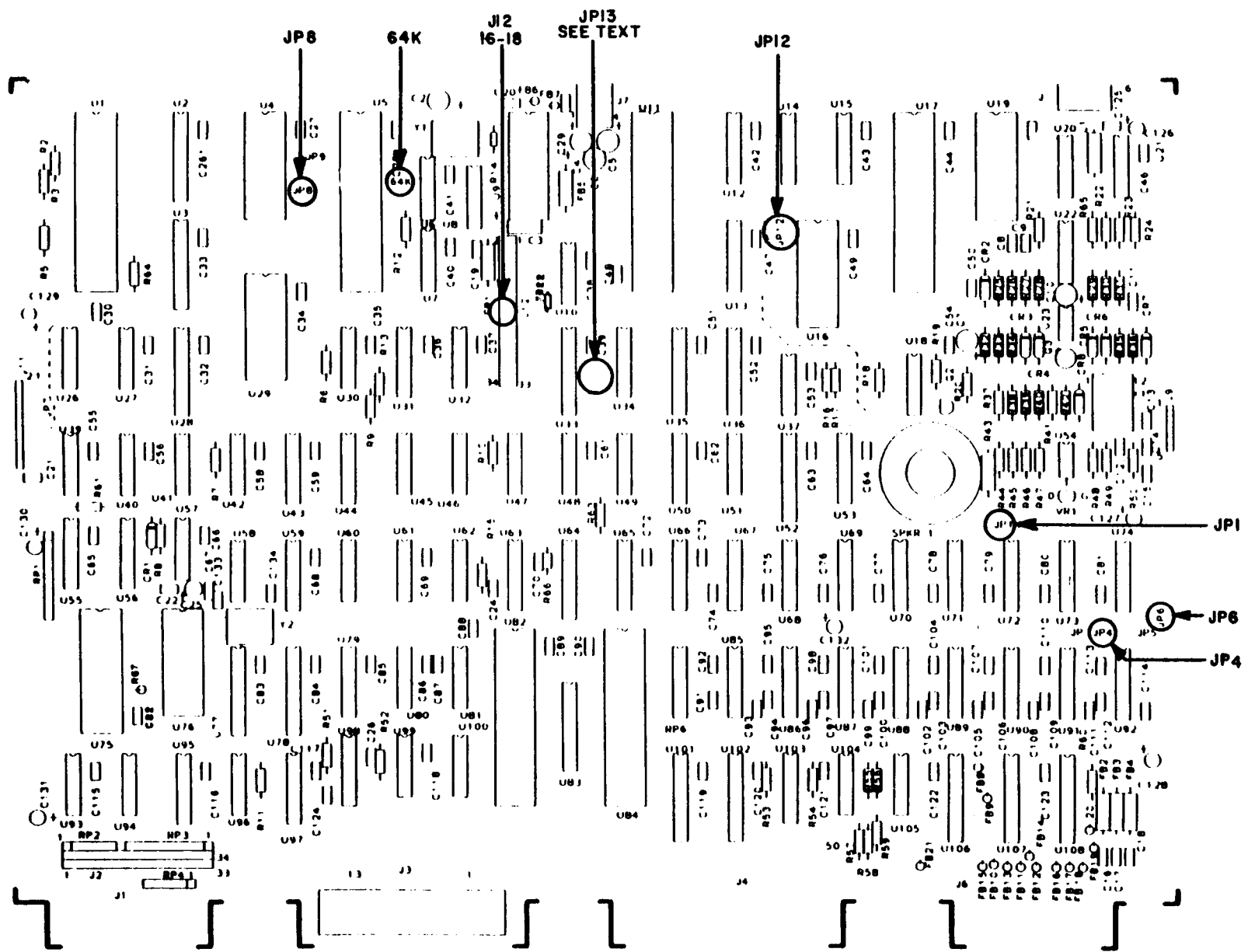

Figure 91. 64K/128K Model 4D Main Logic Board.

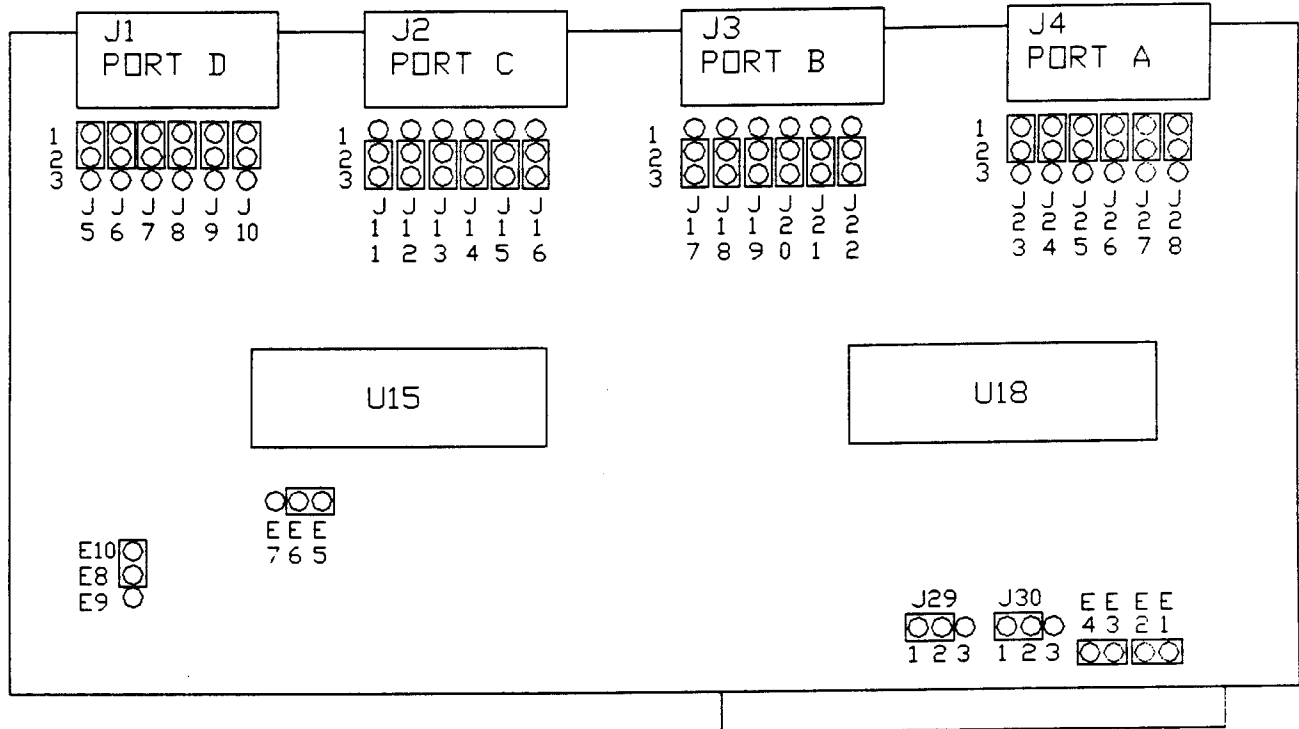

Figure 92. Tandy 2000 Serial Expansion Board

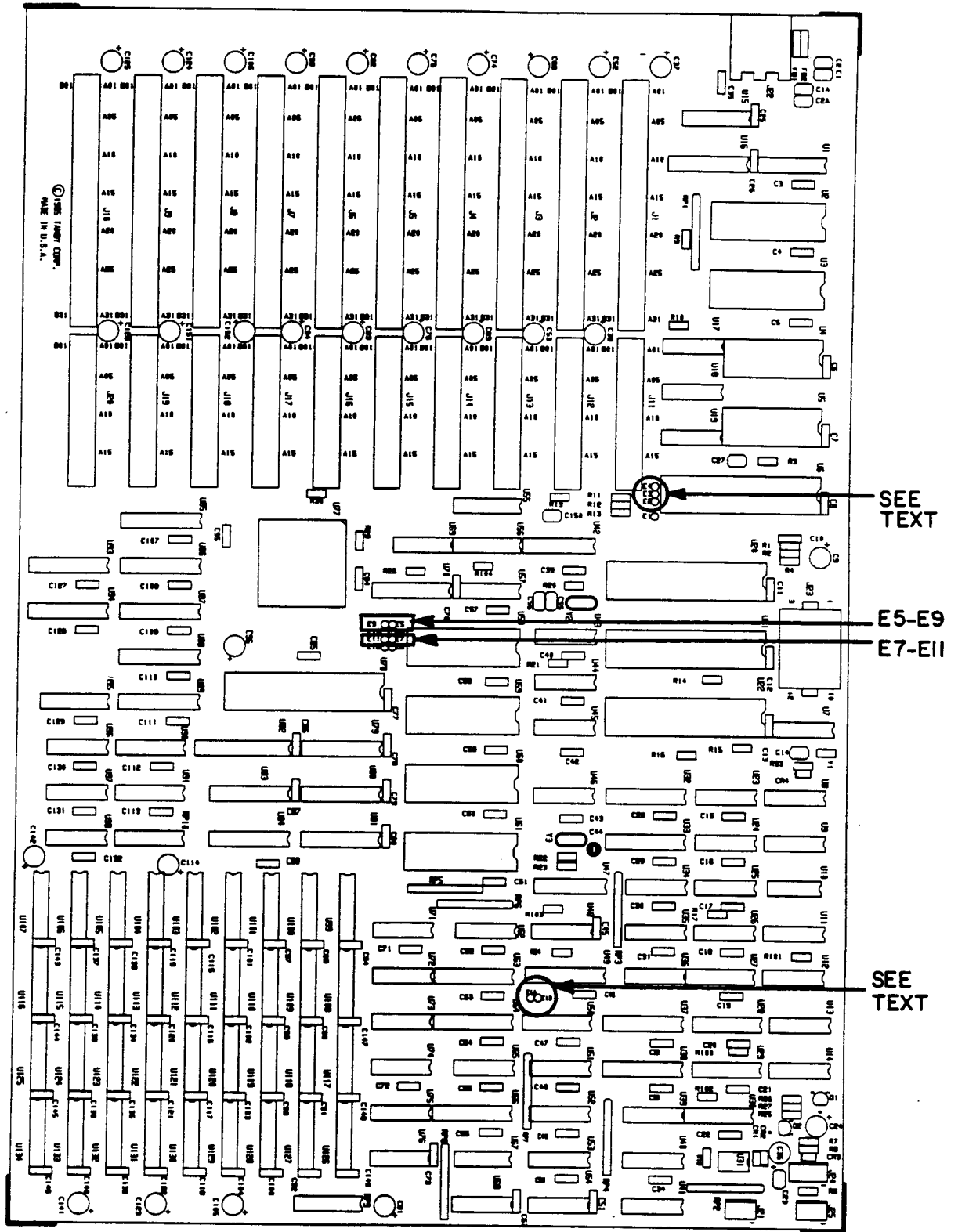

Figure 93. Tandy 3000 Main Logic Board.

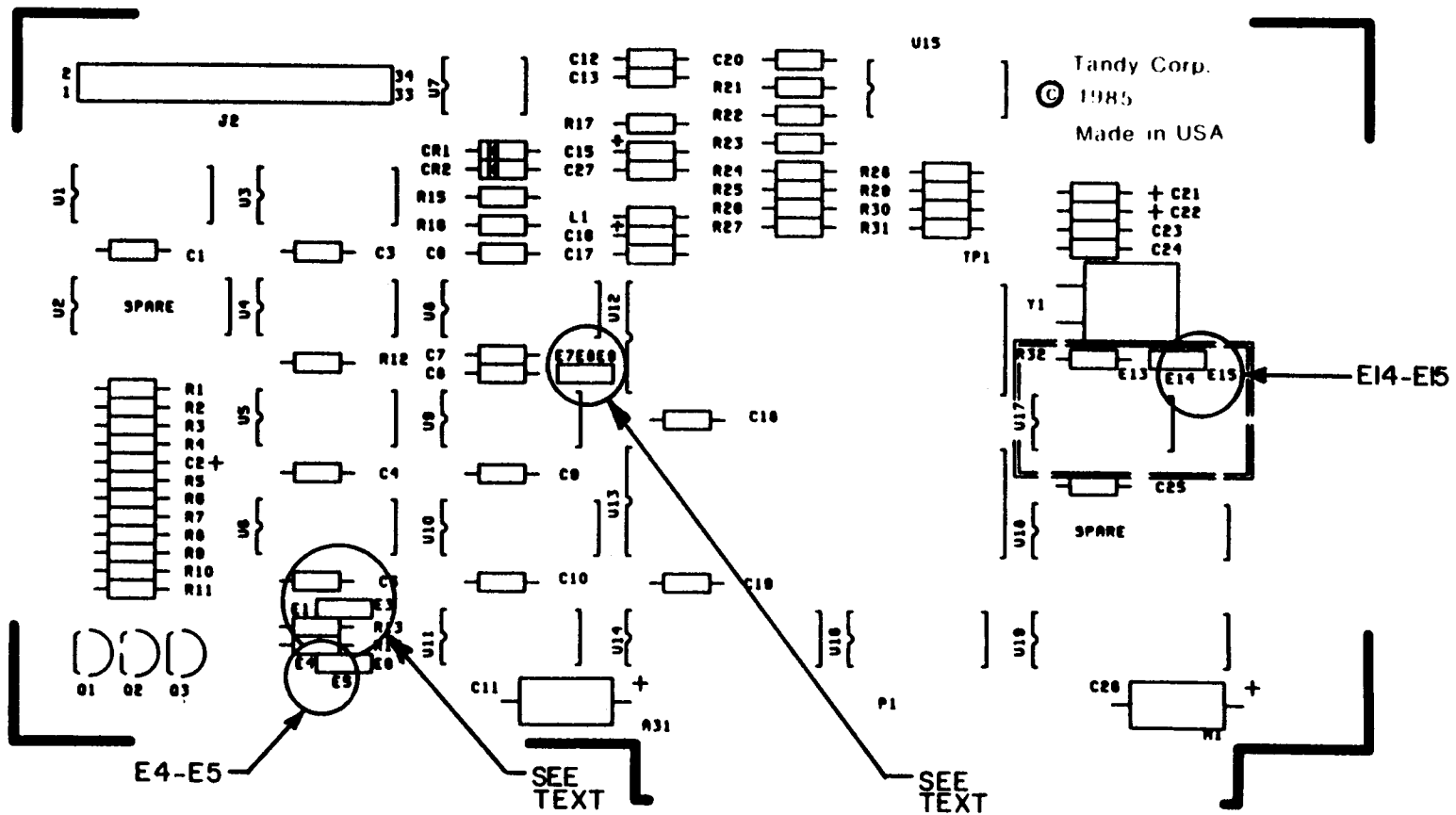

Figure 94. Tandy 3000 Floppy Disk Controller Board.

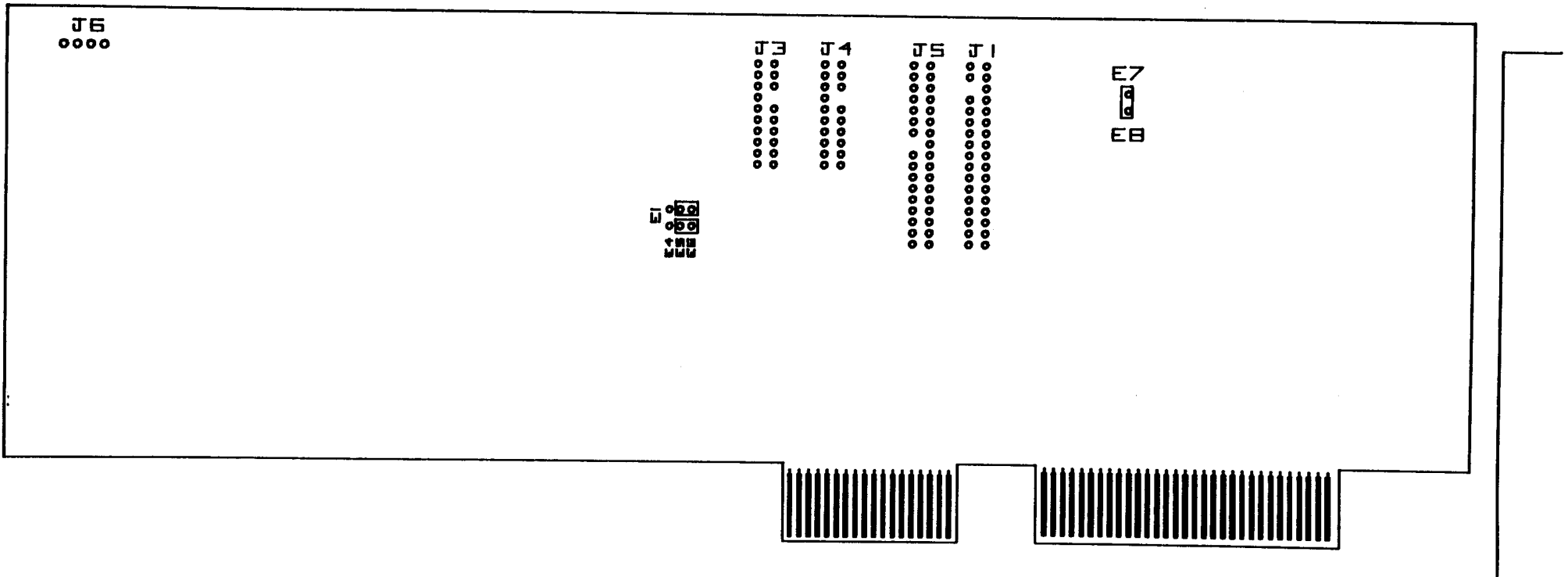

Figure 95. Tandy 3000 Floppy/Hard Disk Controller Board.

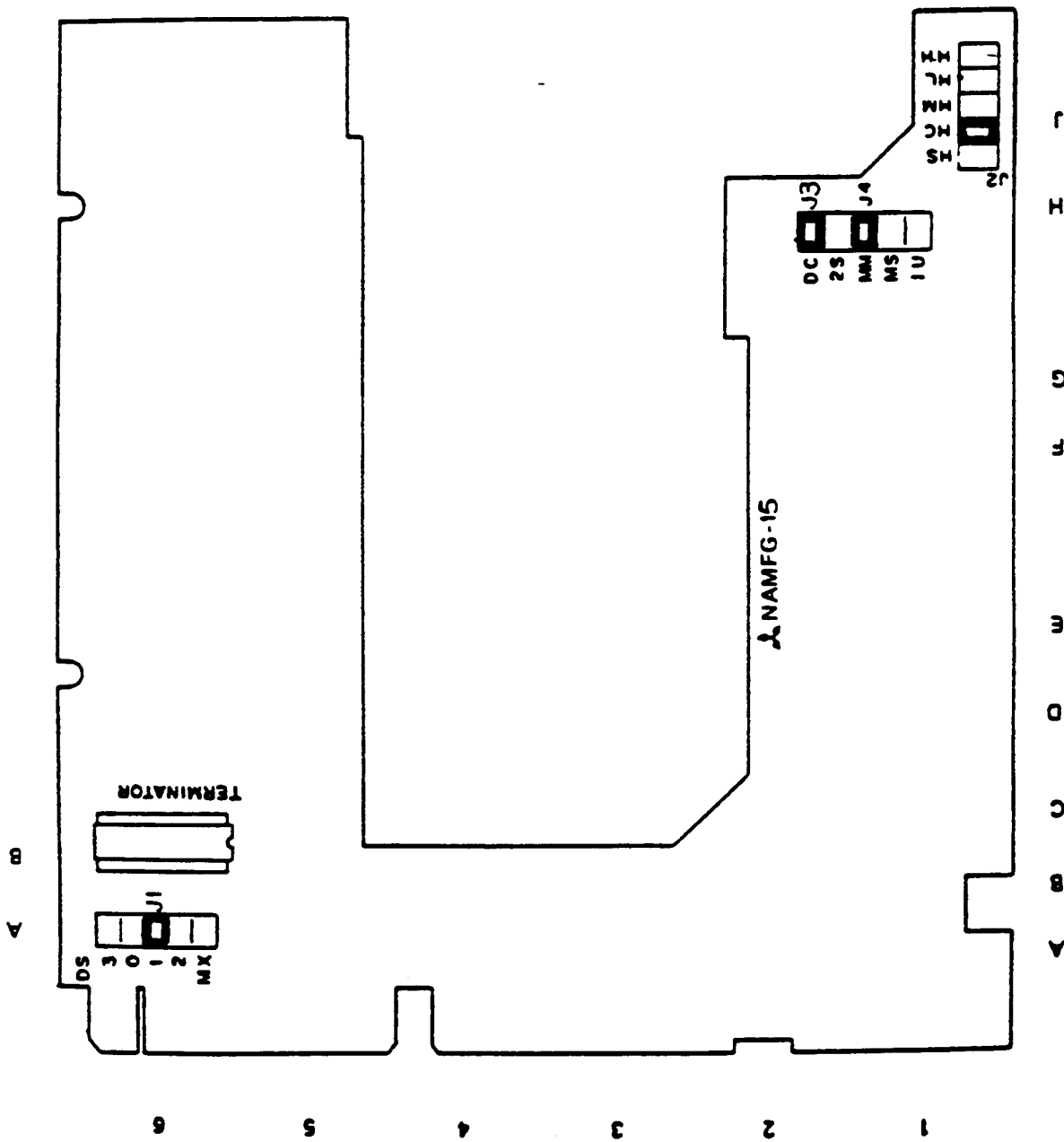

Figure 96. Mitsubishi M4851 Floppy Drive Logic Board.

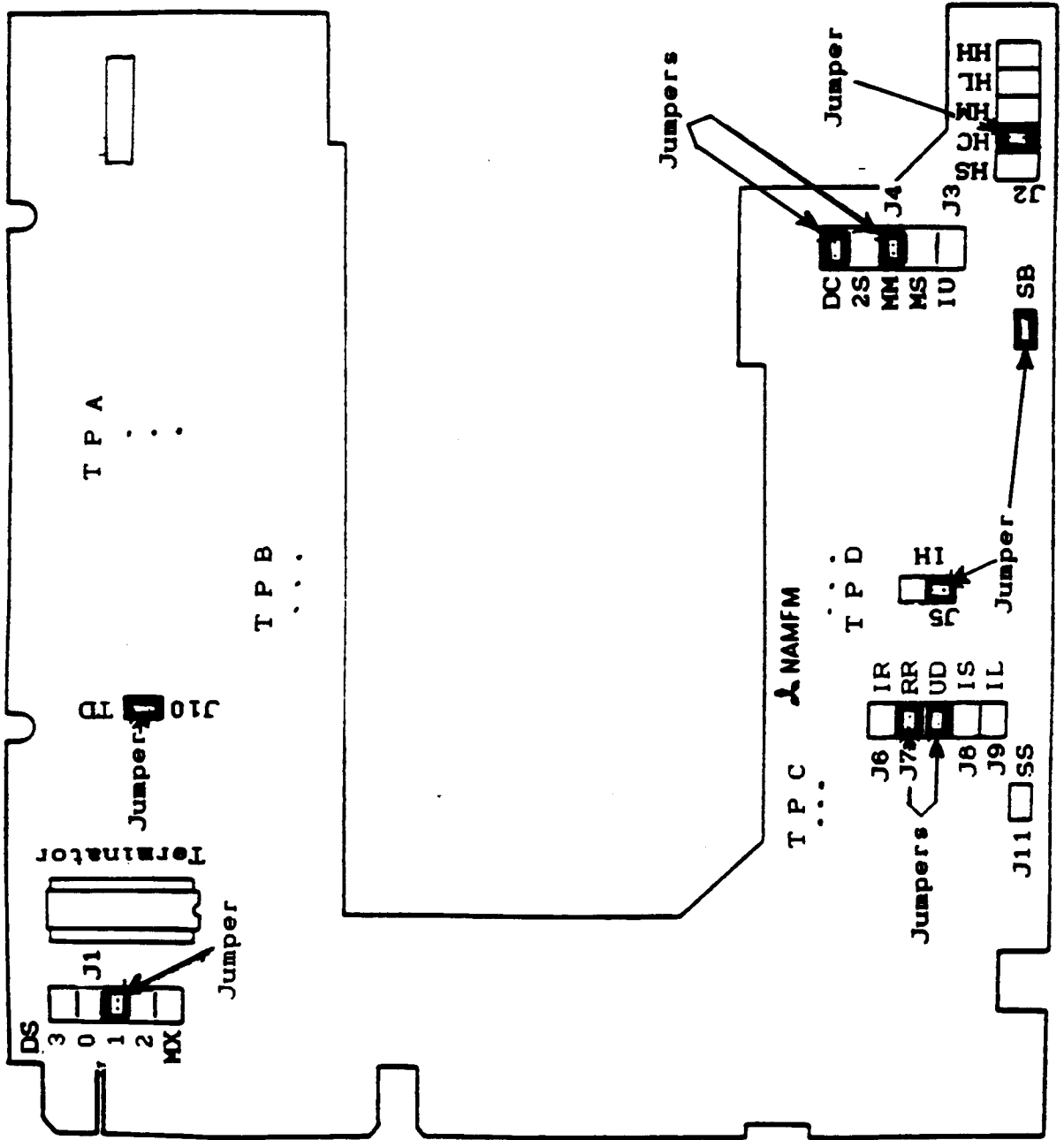

Figure 97. Mitsubishi M4854-347 Floppy Disk Drive Logic Board.

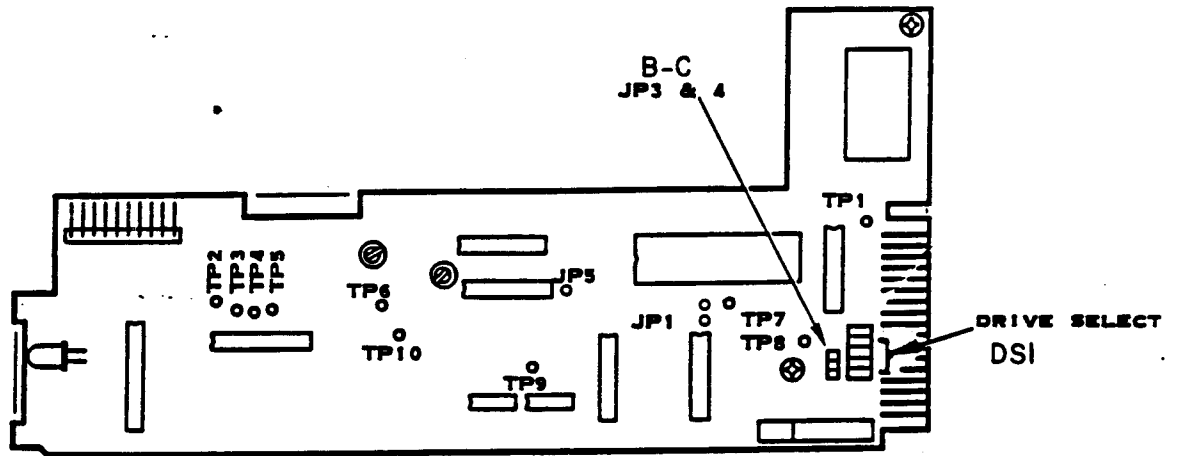

Figure 98. Tandon TM65-2L Floppy Drive Logic Board.

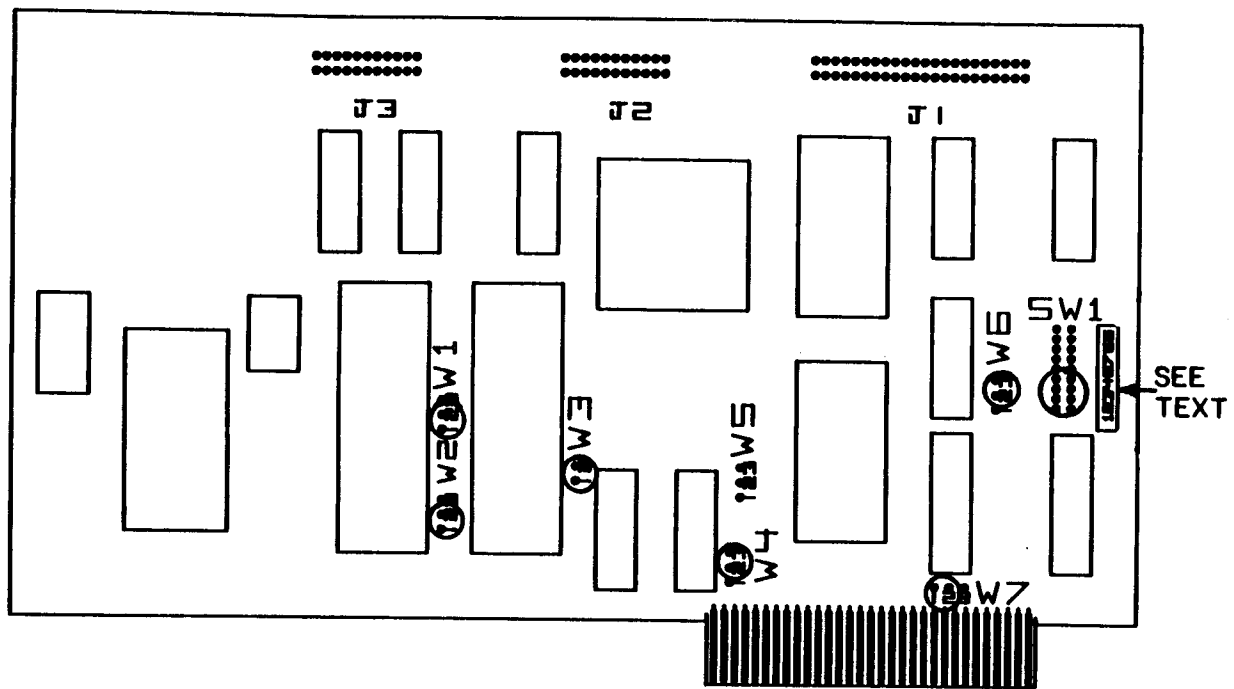
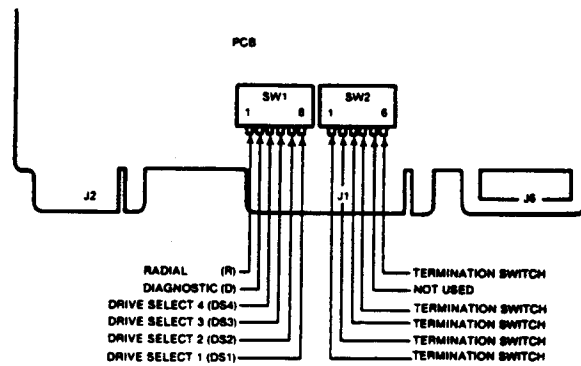

Figure 99. Tandy 1200 WD1010 (short) Hard Drive Controller Board.



	SW1 (Switch Block 1)						SW2 (Switch Block 2)					
	1	2	3	4	5	6	1	2	3	4	5	6
First HD	On	Off	Off	Off	Off	On	On	On	On	On	On	On
Second HD	On	Off	Off	Off	On	Off	Off	Off	Off	Off	Off	Off

Figure 100. 20 MEG Mitsubishi (MR522) Hard Drive Logic Board.

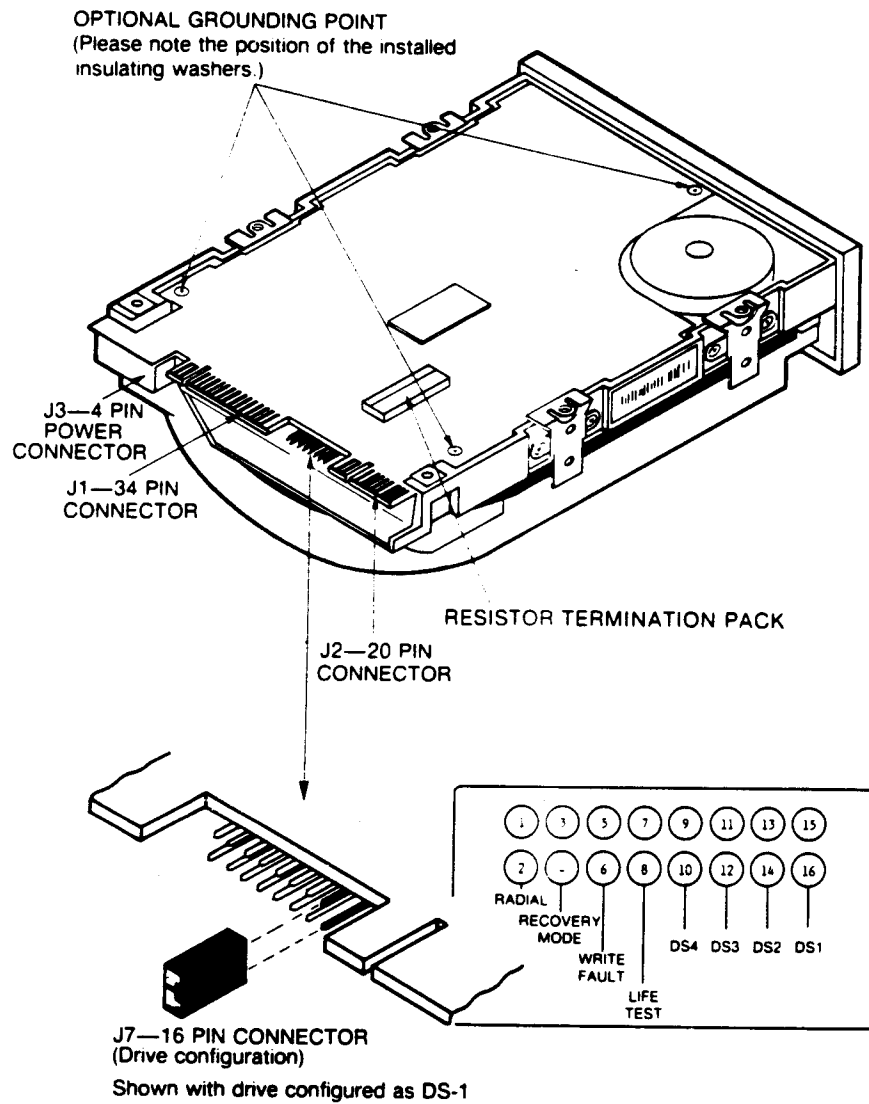

Figure 101. 20 MEG Seagate (ST225) Hard Drive Logic Board.

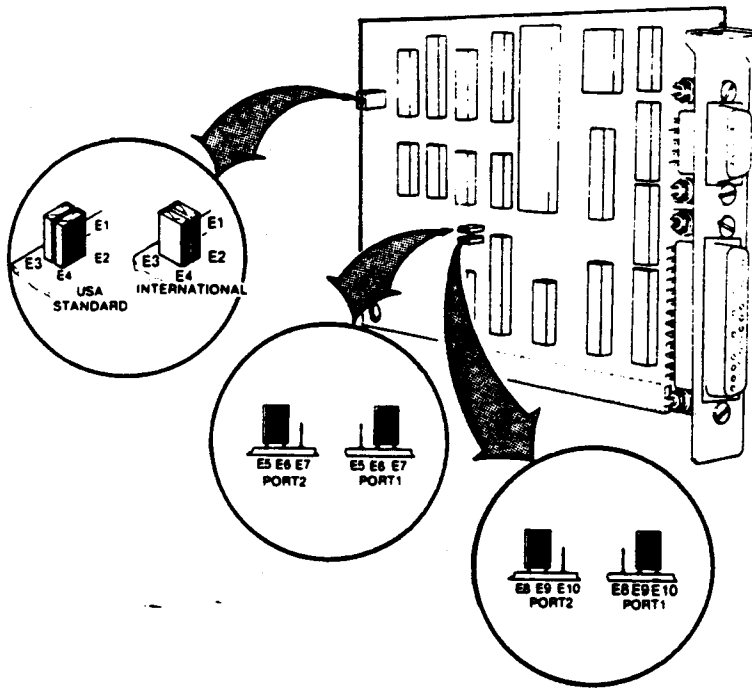

Figure 102. Tandy 3000 Serial/Parallel Board.

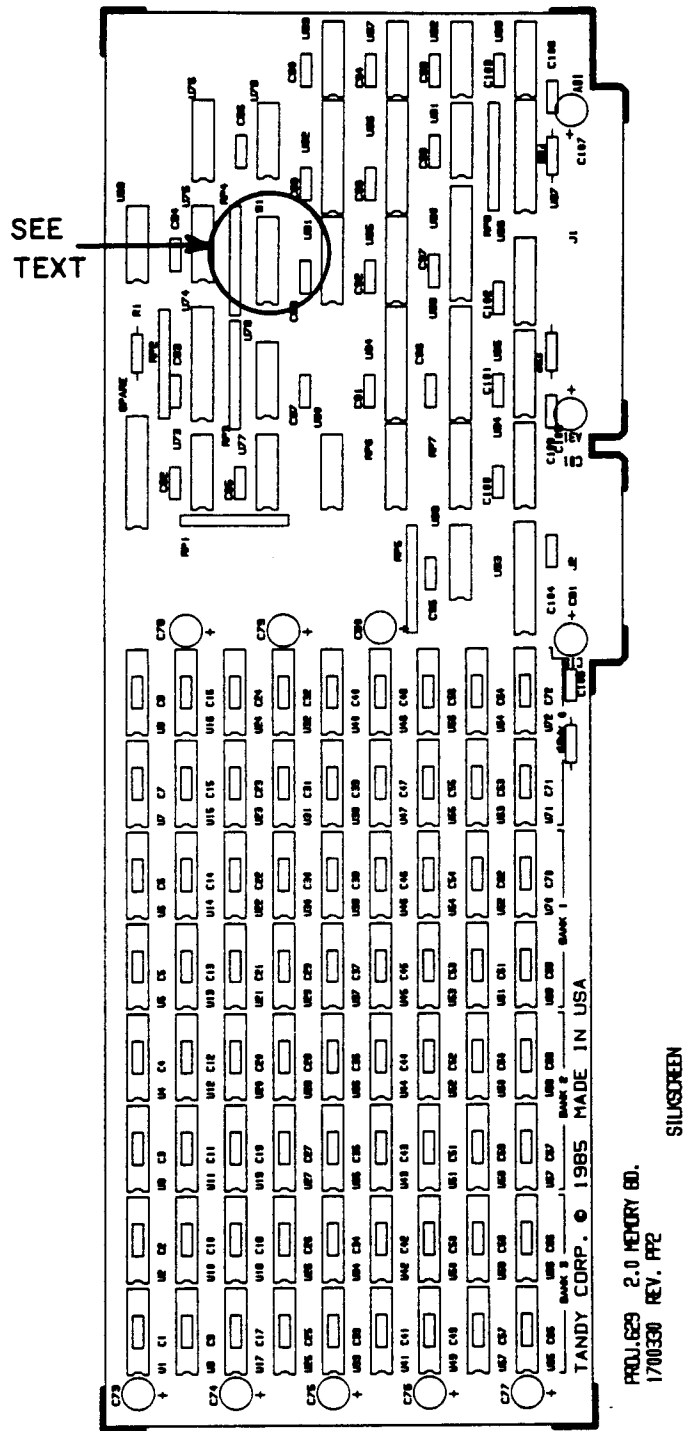

Figure 103. Tandy 3000 2 MEG Memory Board.

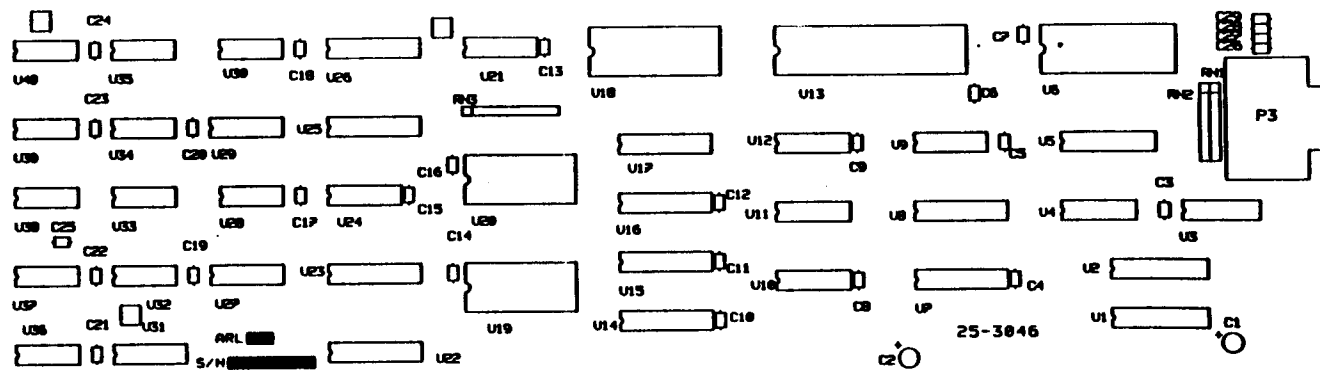

Figure 104. Deluxe Text Display Adapter (Tandy 1200/3000).

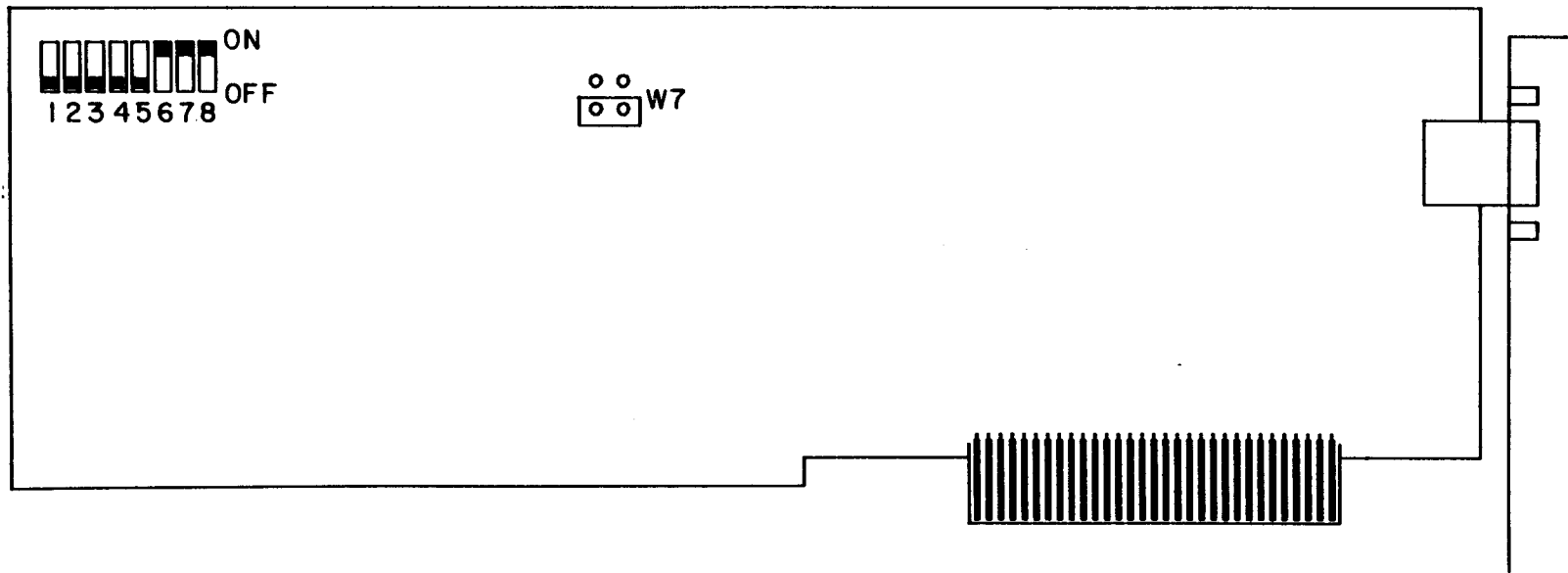

Figure 105. Deluxe Graphics Display Adapter (Tandy 1200/3000).

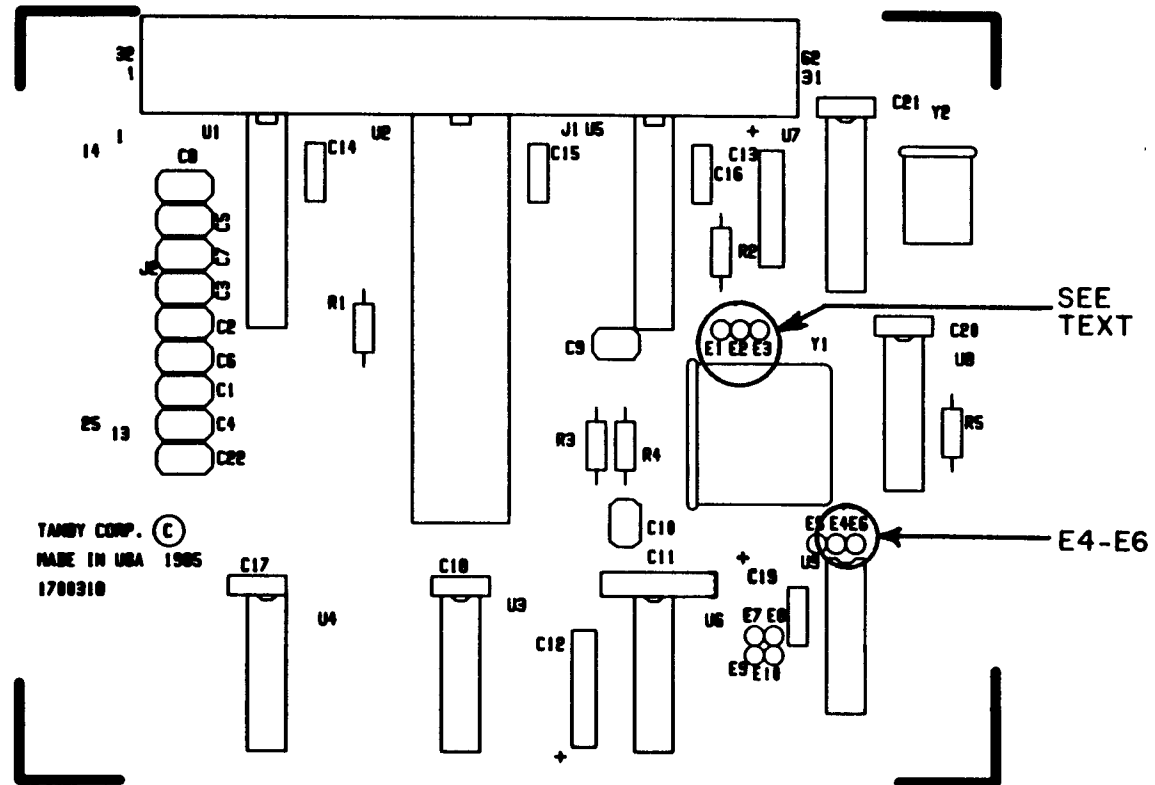

Figure 106. RS-232 Plus Board.

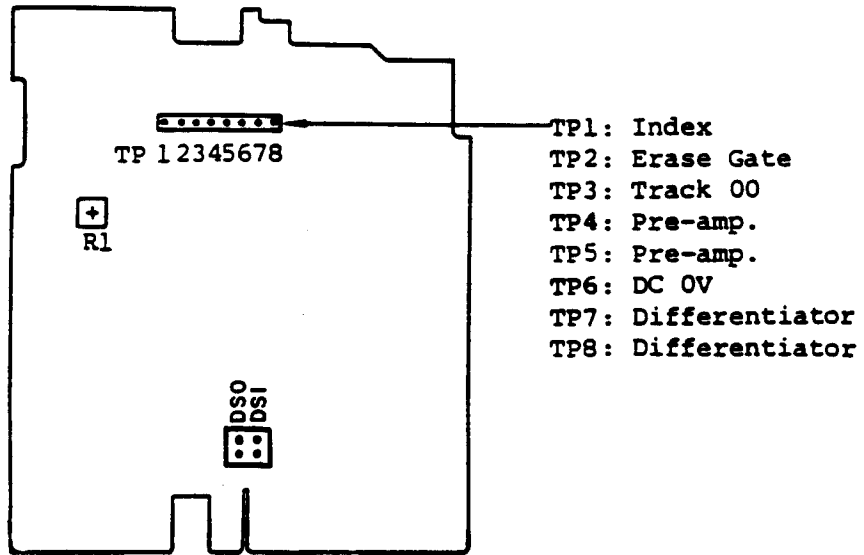

Figure 107. TEAC FD-55BV Floppy Drive Logic Board.

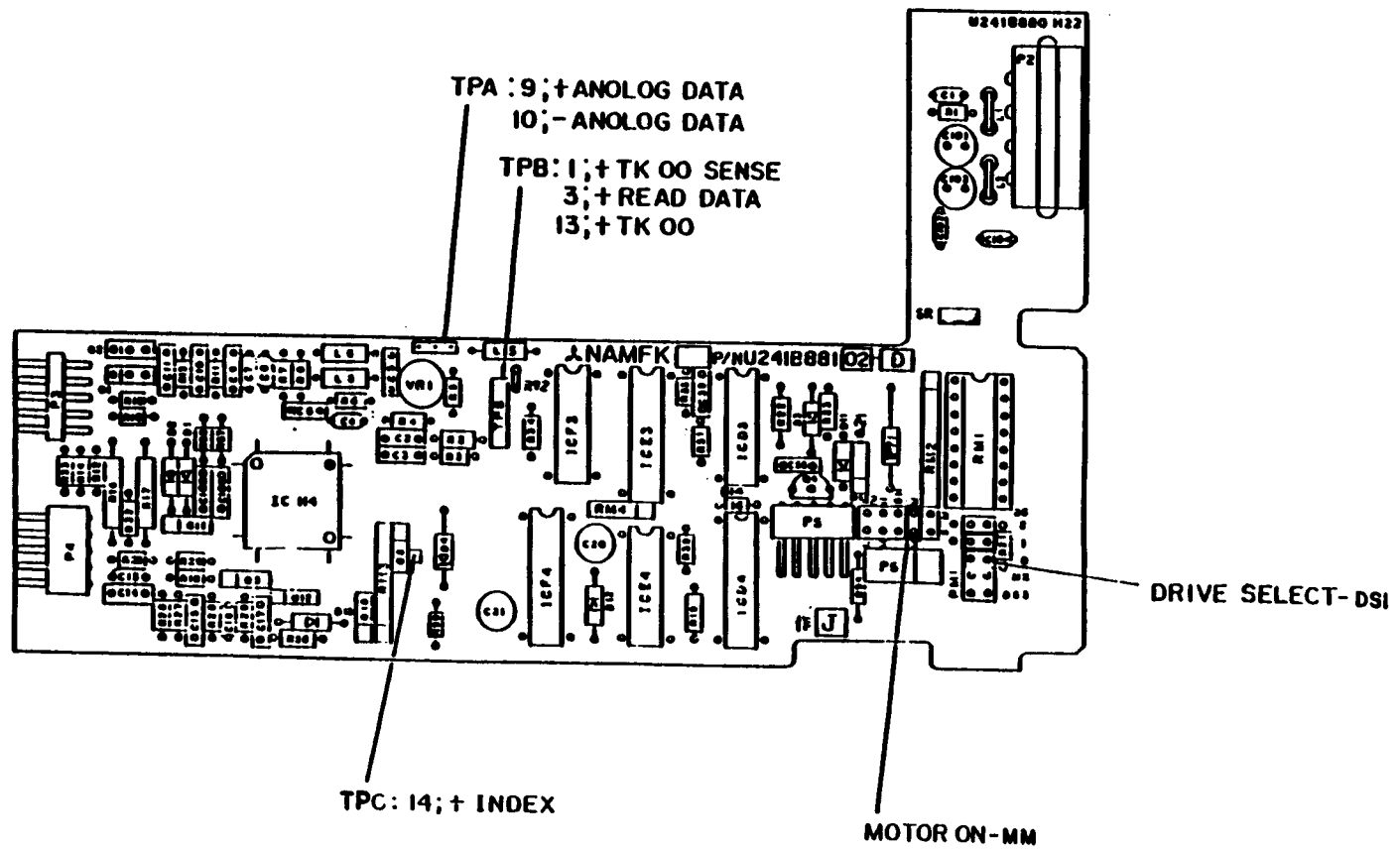

Figure 108. Mitsubishi MF501A Floppy Drive Logic Board.

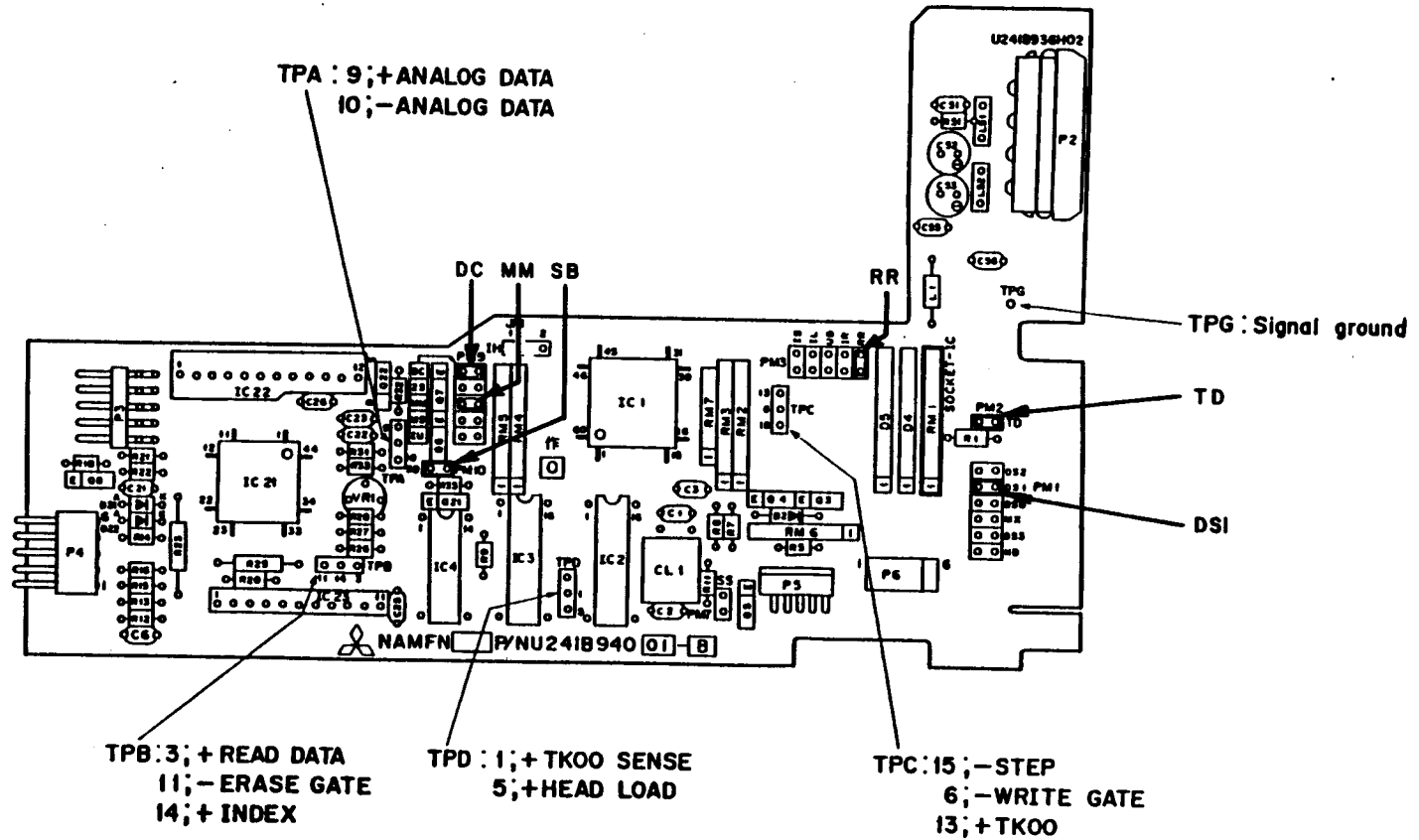

Figure 109. Mitsubishi MF504A Floppy Drive Logic Board.

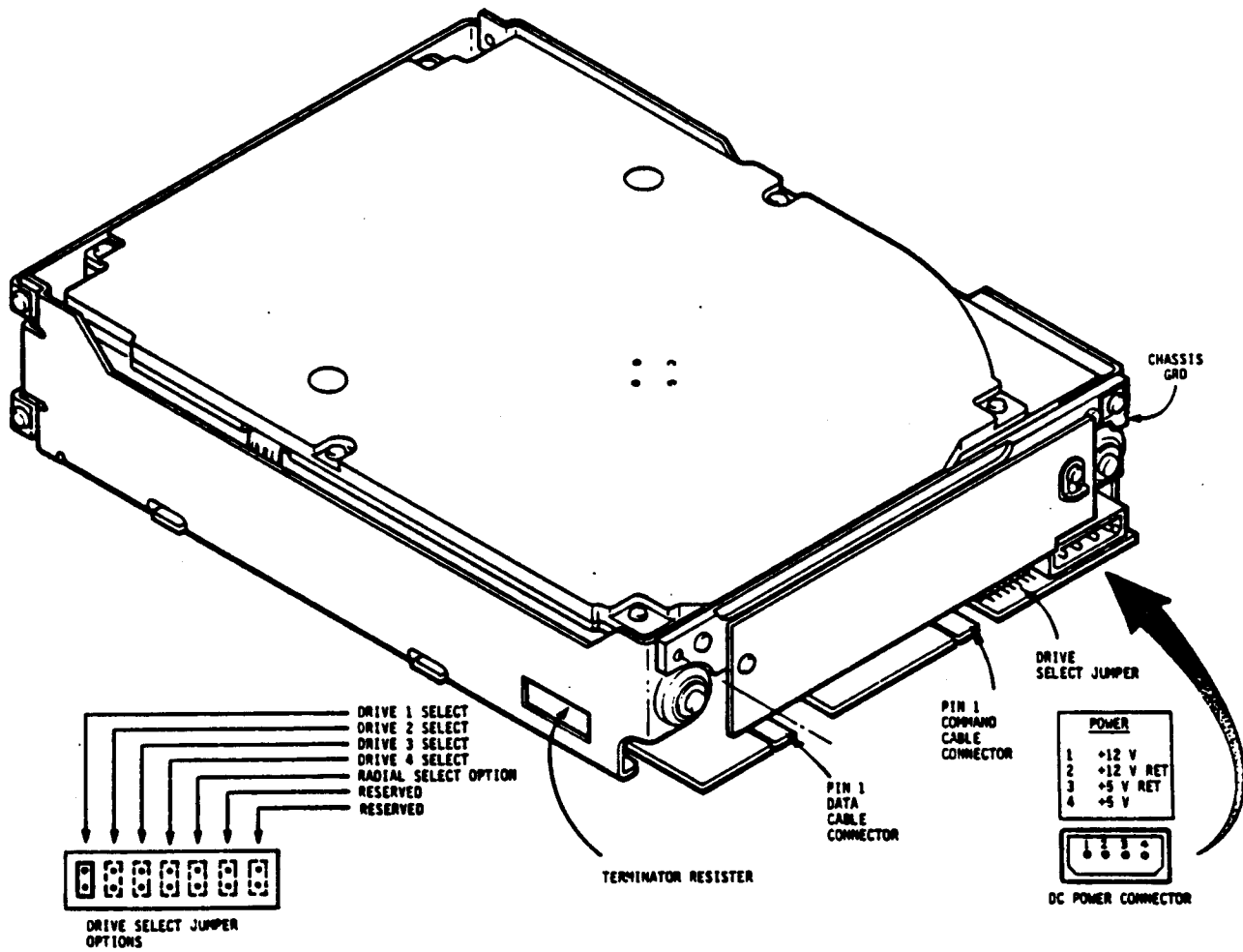

Figure 110. 40 MEG CDC (WREN II) Hard Drive Logic Board.

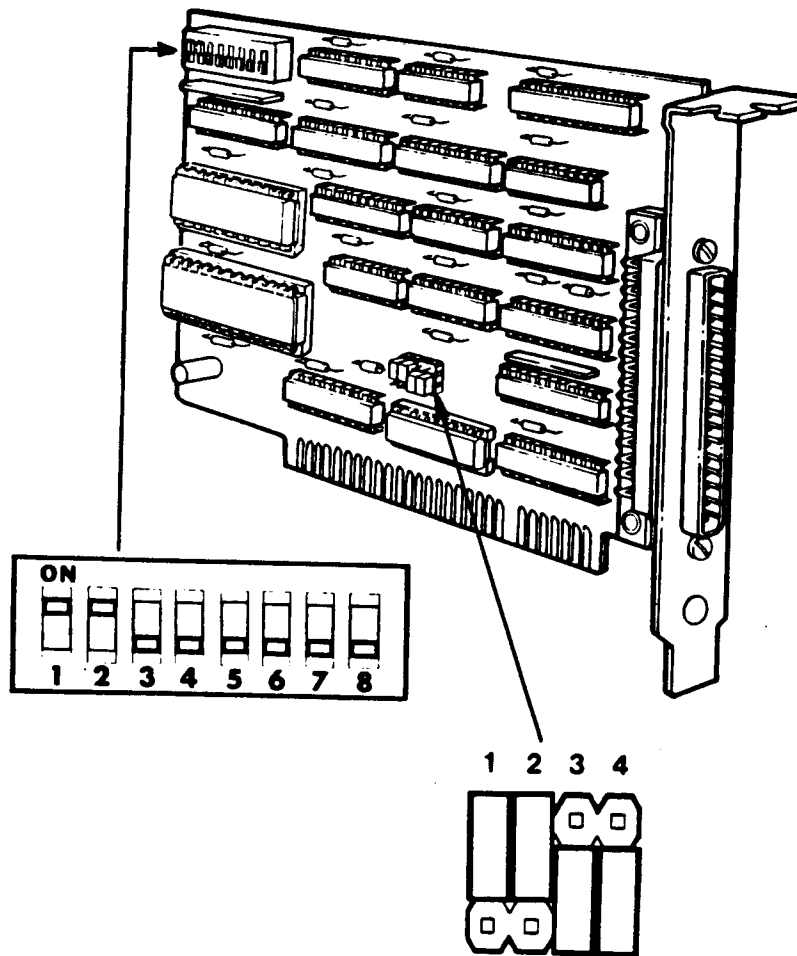

Figure 111. PC2B Disk Cartridge Interface Board.

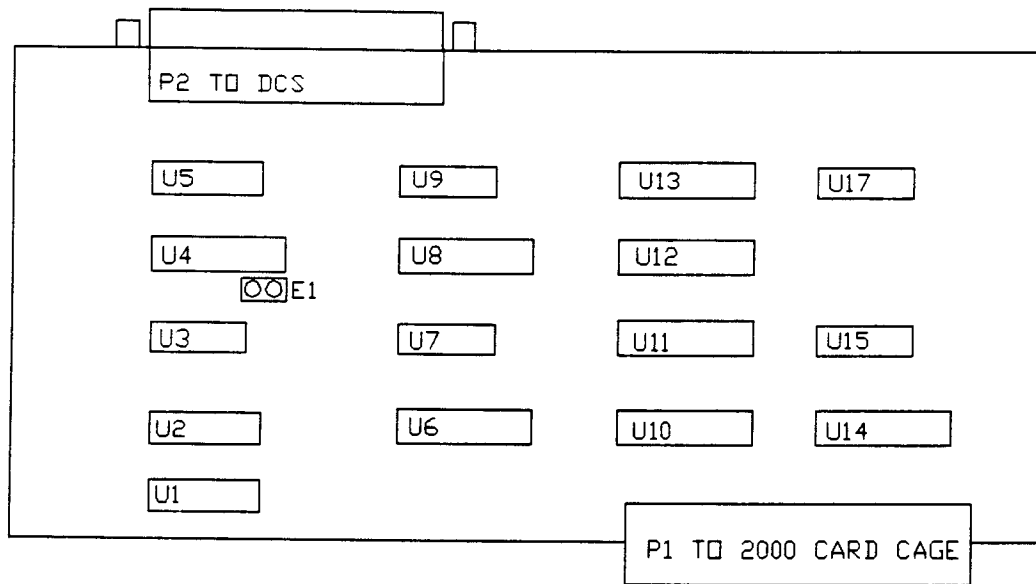

Figure 112. Tandy 2000 Disk Cartridge Interface board

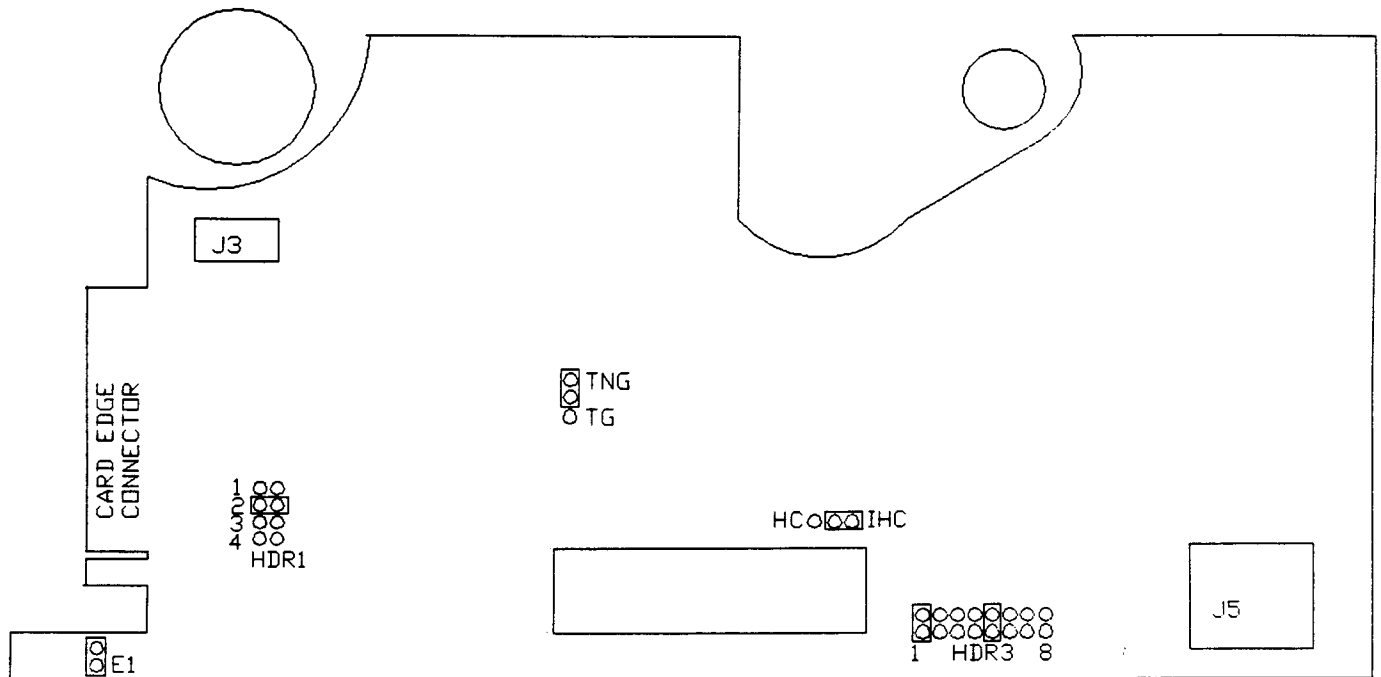

Figure 113. Tape Cartridge Drive Logic board Rev. C2 (TCS 100)

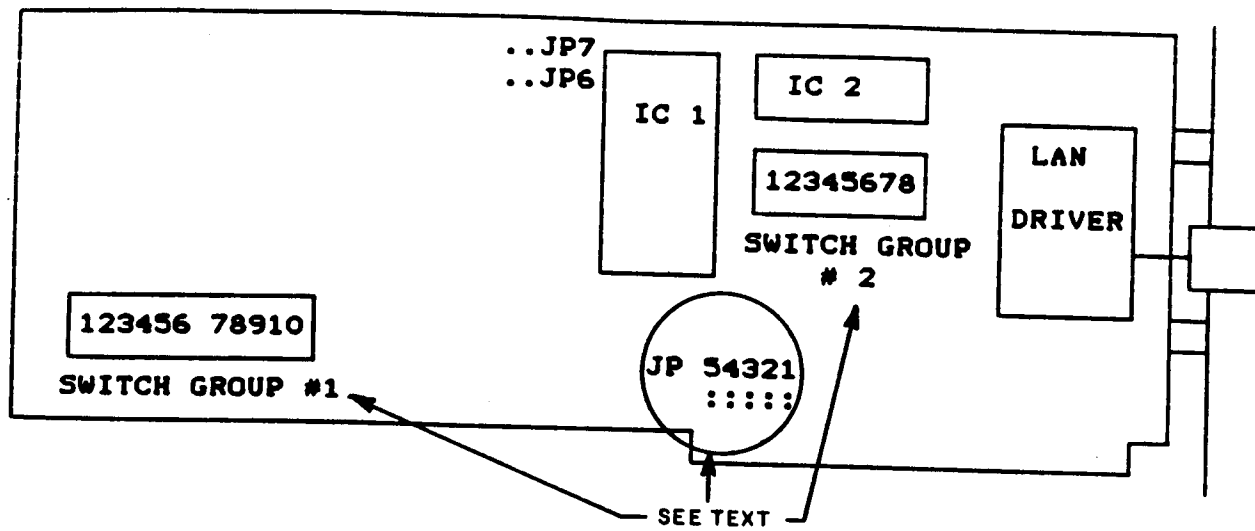

Figure 114. Vianet (Arcnet-PC100) Board (1000/1200/3000).

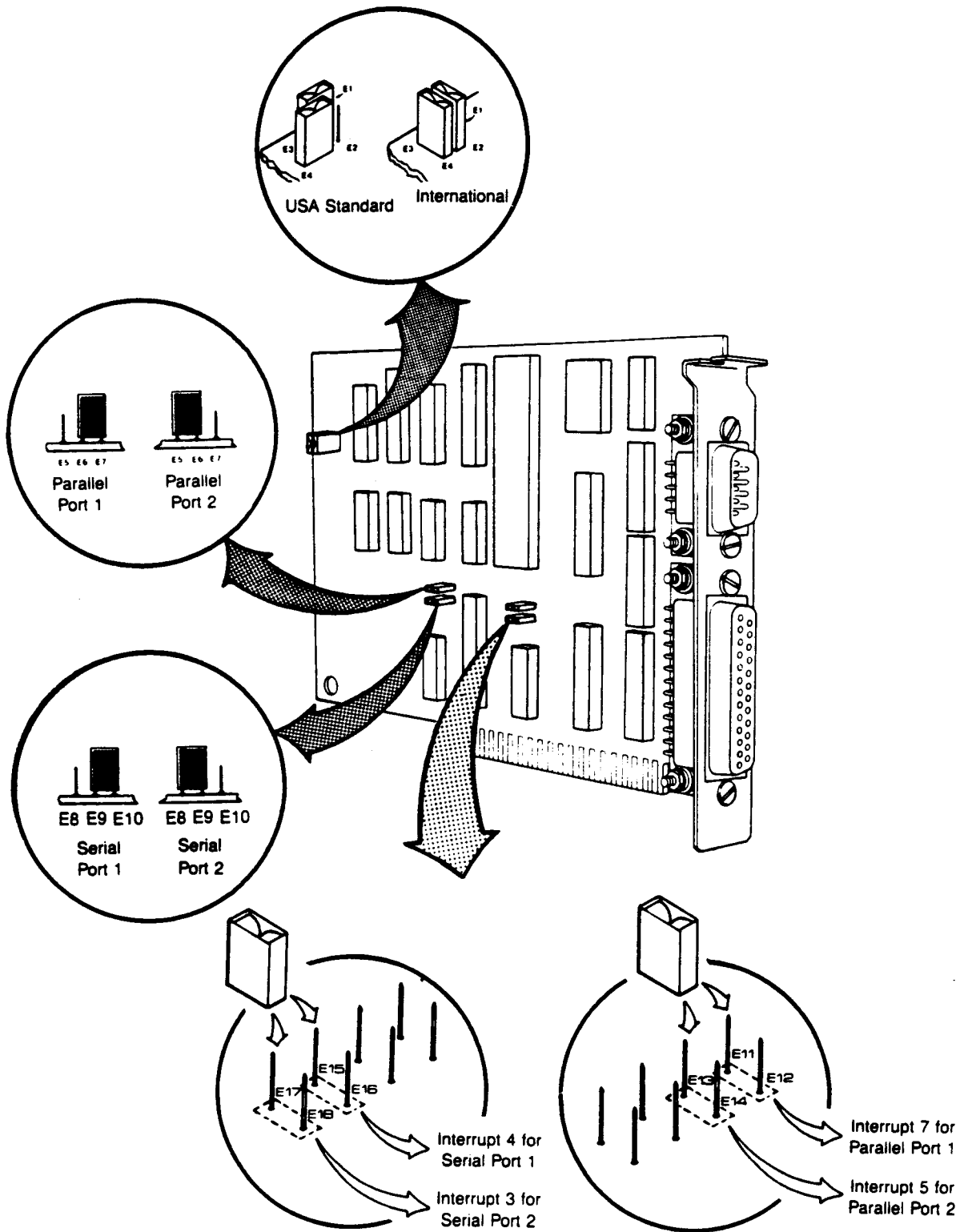

Figure 115. Serial/Parallel Board Revisions B/C

Default Display Mode		
	2	1
Mono	OFF	ON
Color	ON	OFF
Emulation	OFF	OFF

Monitor Type		
	4	3
Composite	ON	OFF
Monochrome or RGB	OFF	ON
IBM Enhanced	OFF	OFF

Composite Monitor	
	5
Color	ON
Monochrome	OFF

ALWAYS OFF 6

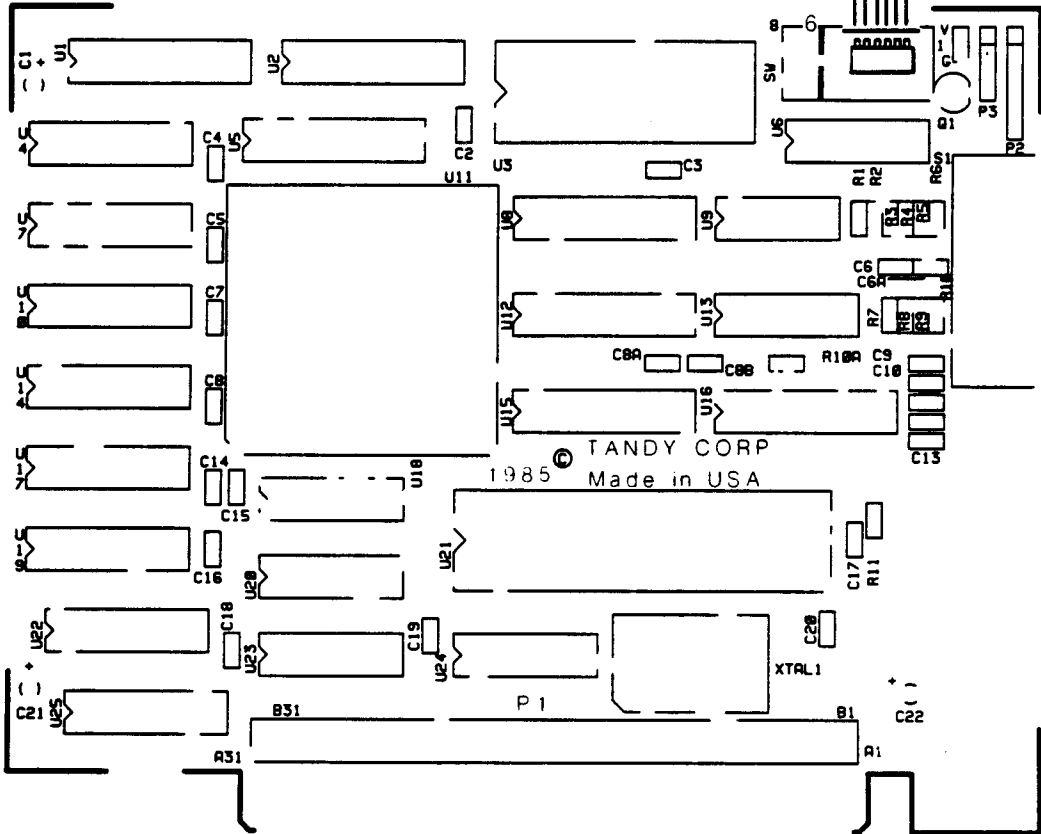

Figure 116. Dual Display Graphics Adapter

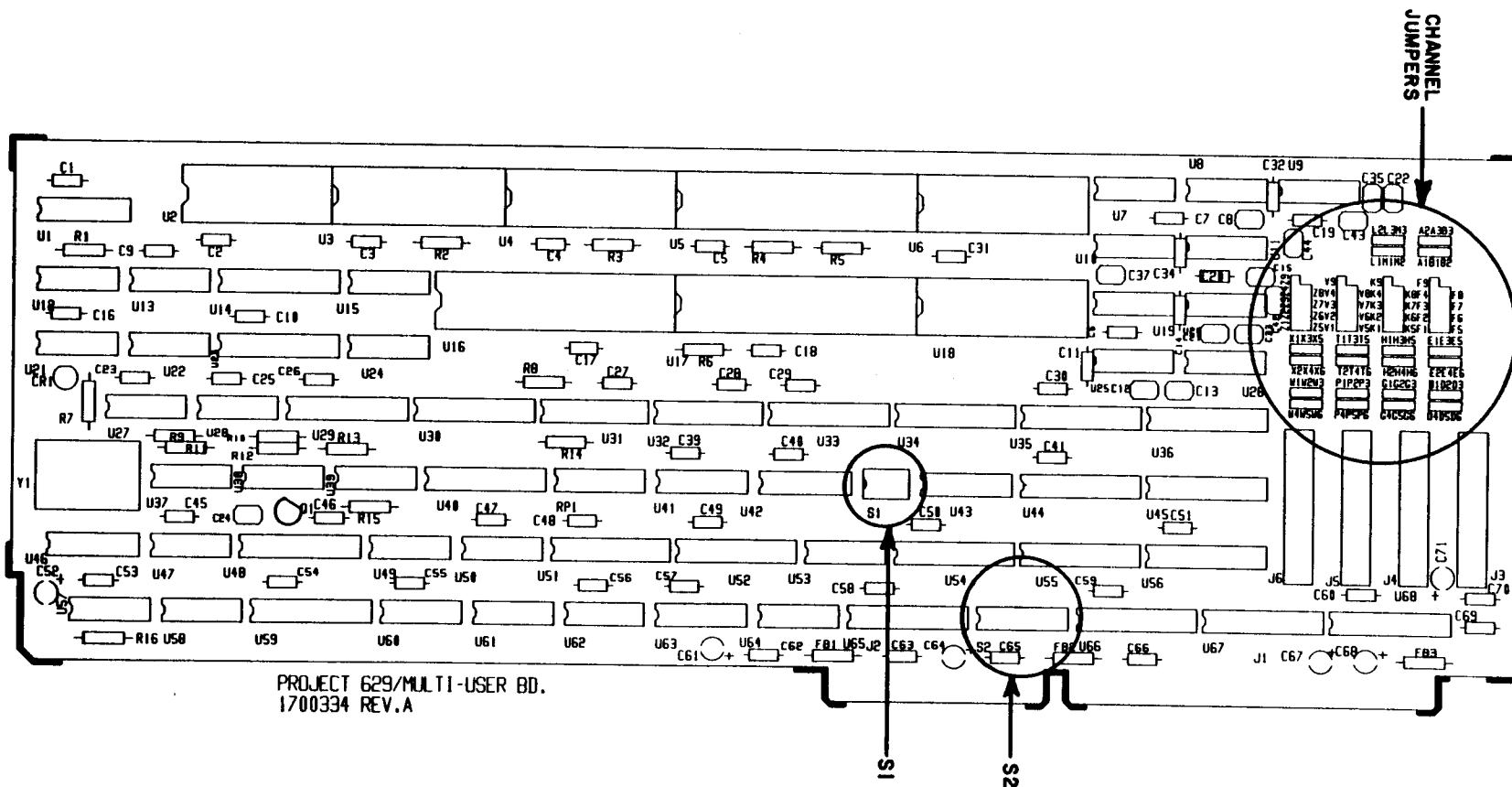

Figure 117. Tandy 3000 Multi-Terminal Board.

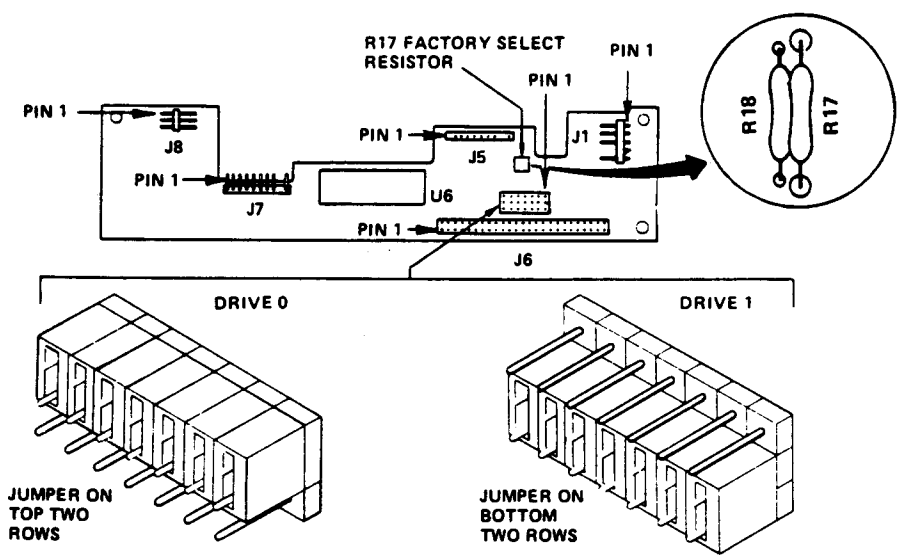

Figure 118. 20 MEG IOMEGA (Alpha-20H) Disk Cartridge Drive Logic.

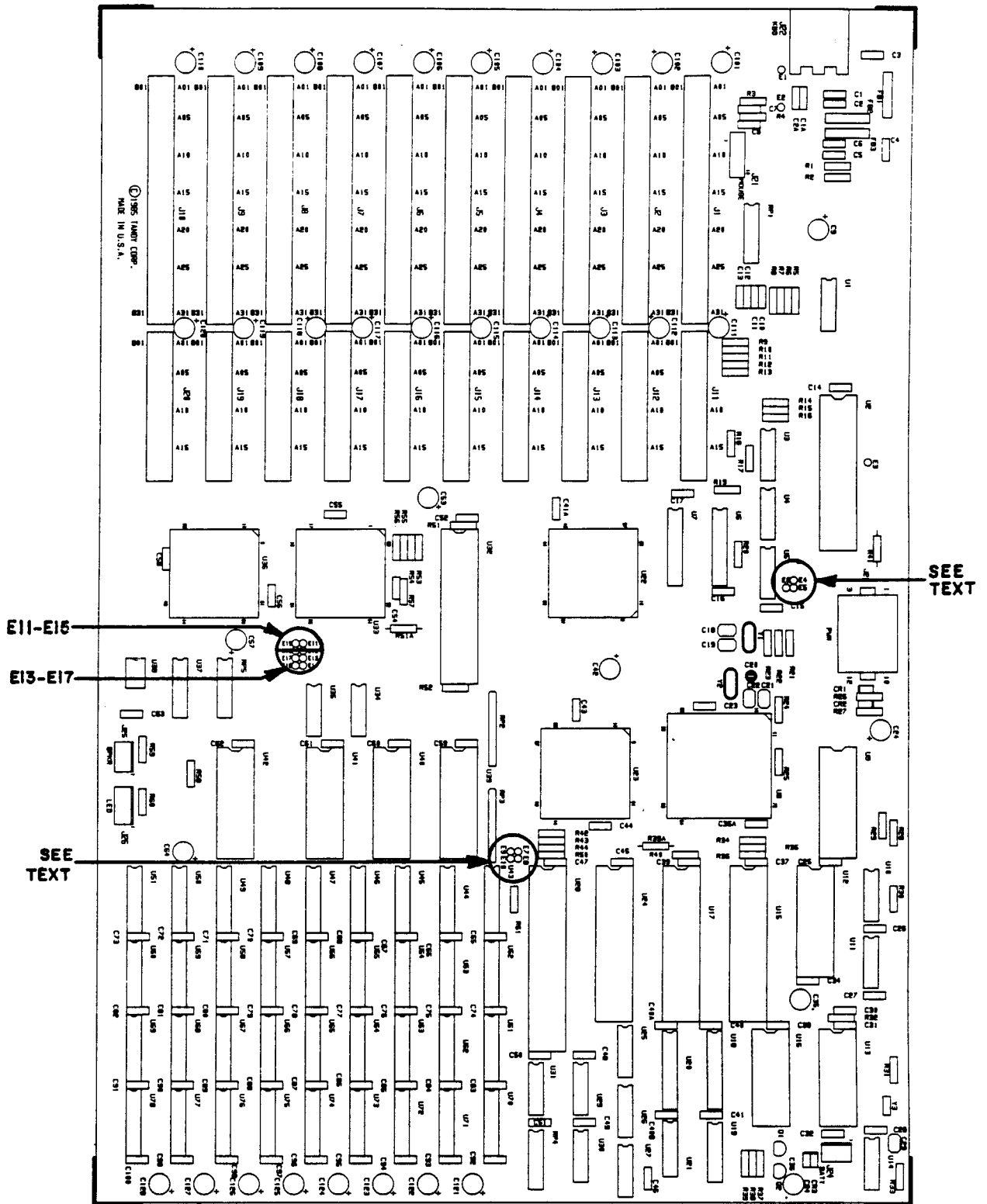
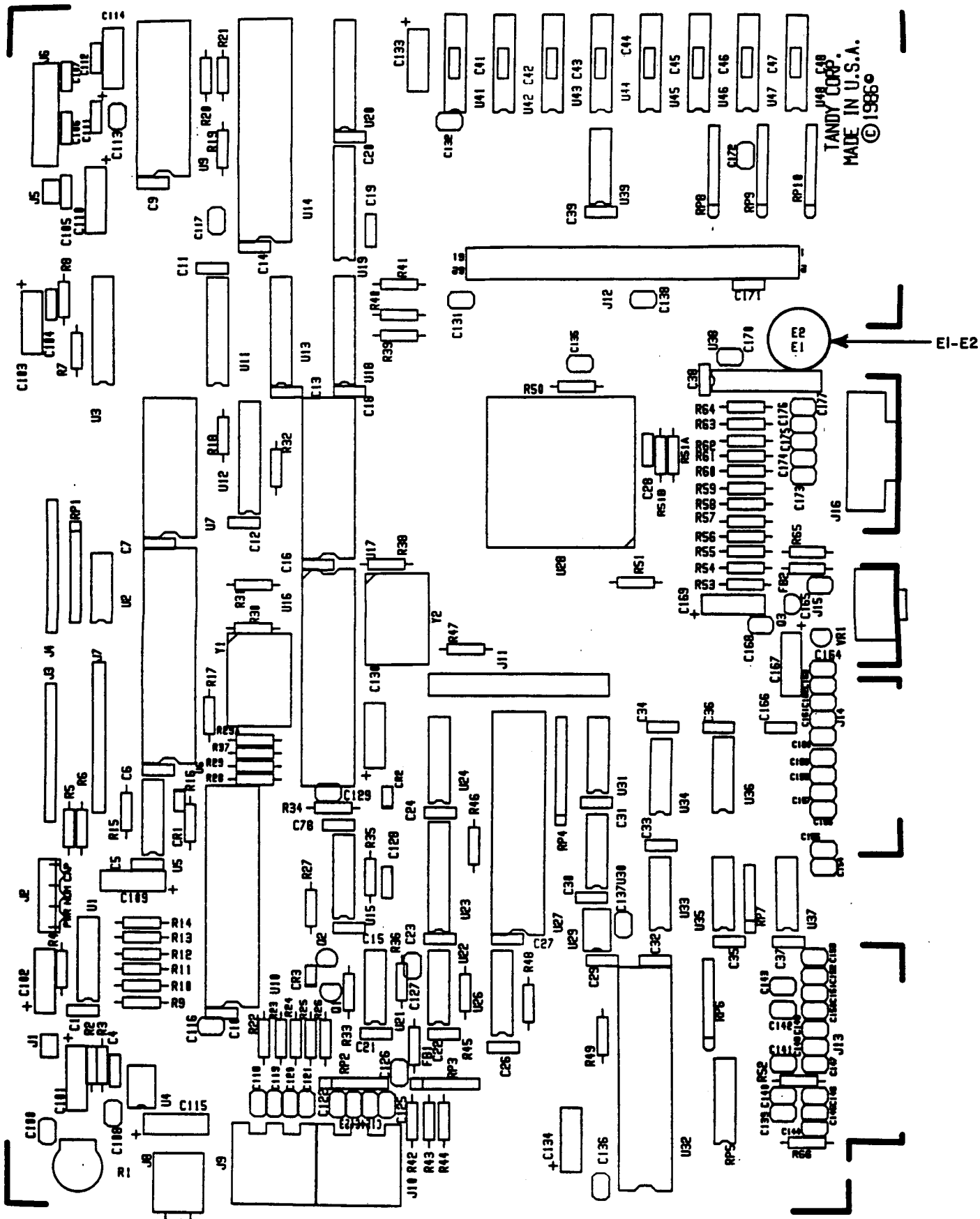

Figure 119. Tandy 3000 Gate Array Main Logic Board.



TANDY CORP.
MADE IN U.S.A.
© 1986

Figure 120. Tandy 1000 EX Main Logic Board.

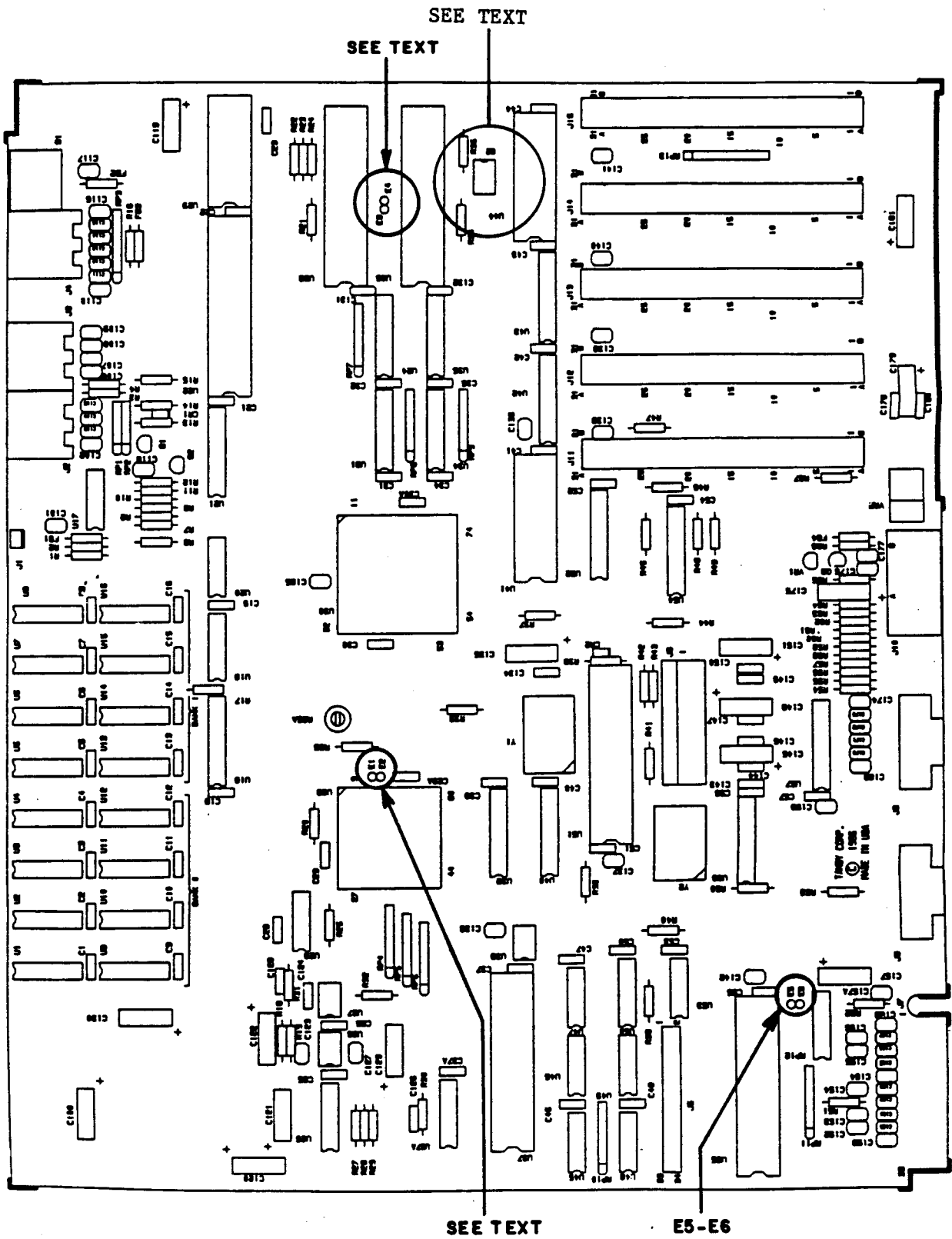

Figure 121. Tandy 1000 SX Main Logic Board.

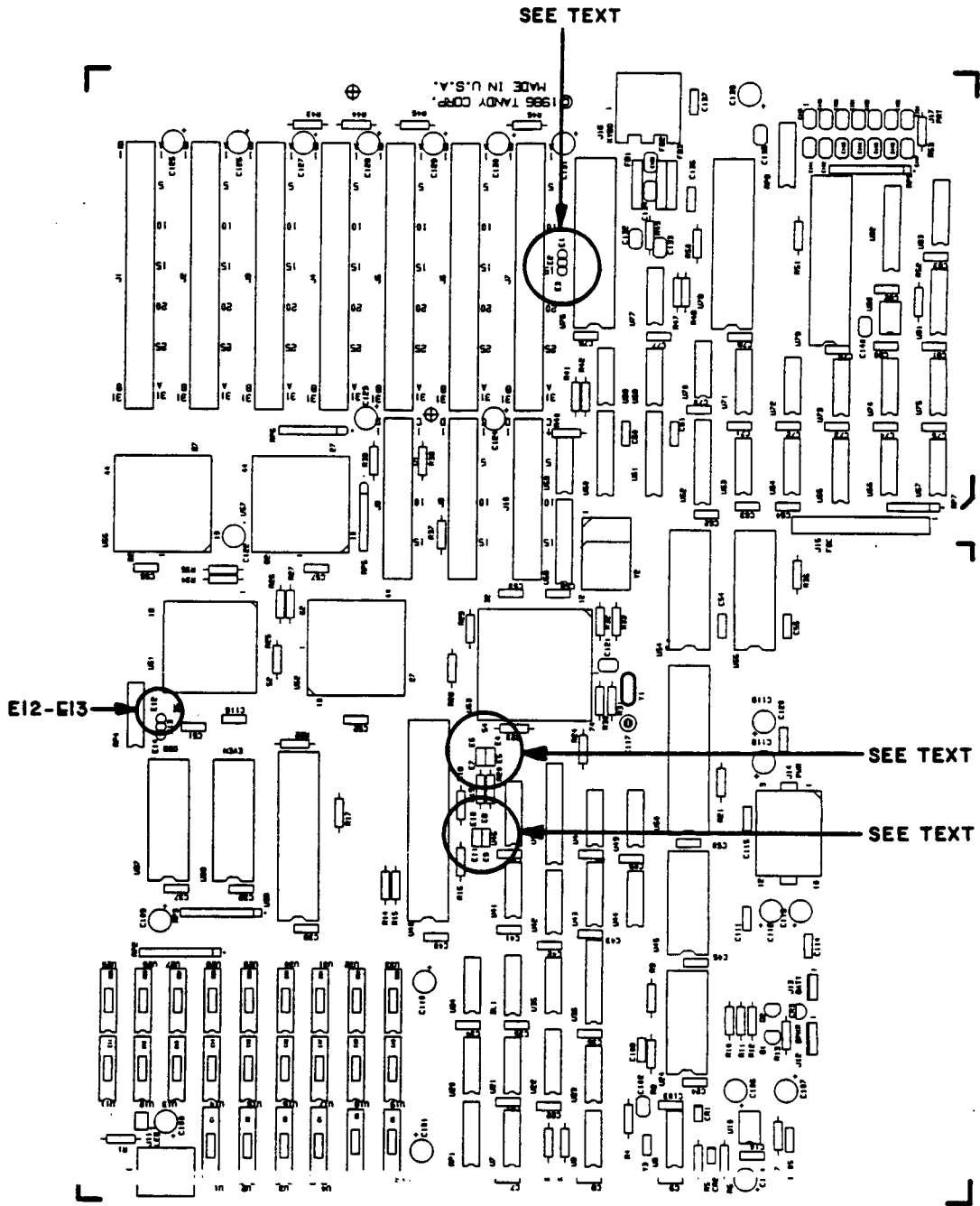

Figure 122. Tandy 3000 HL Main Logic Board.

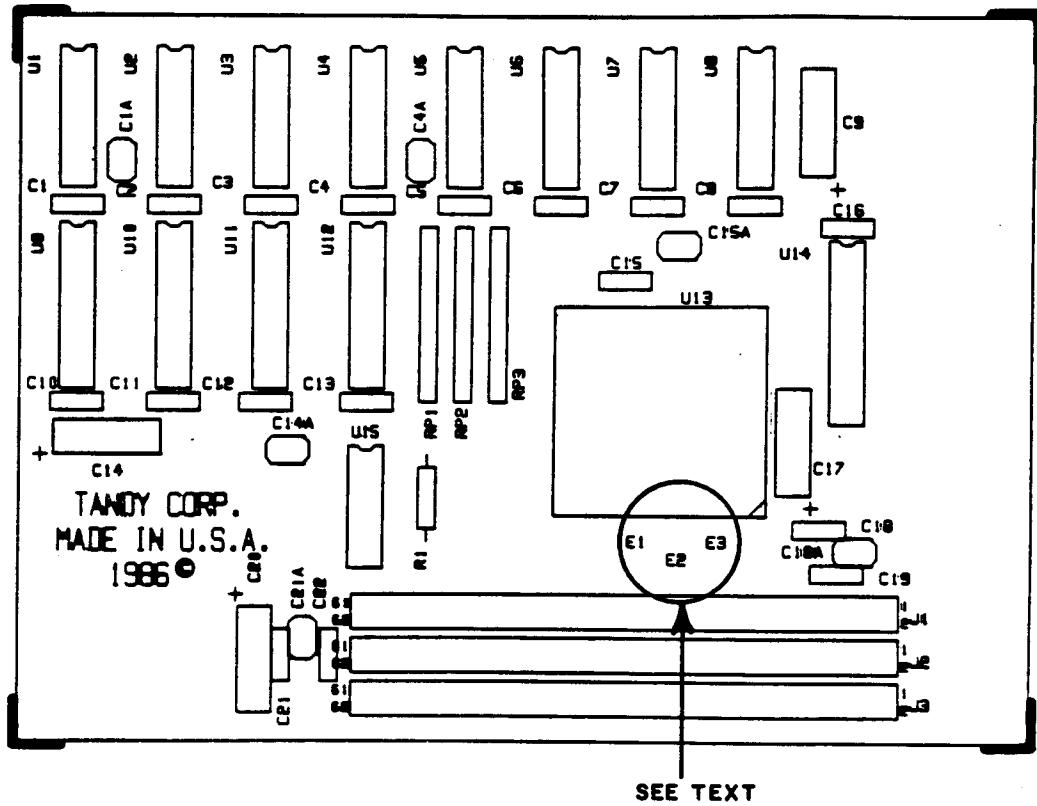

Figure 123. Tandy 1000 EX Memory PLUS Expansion Adapter.

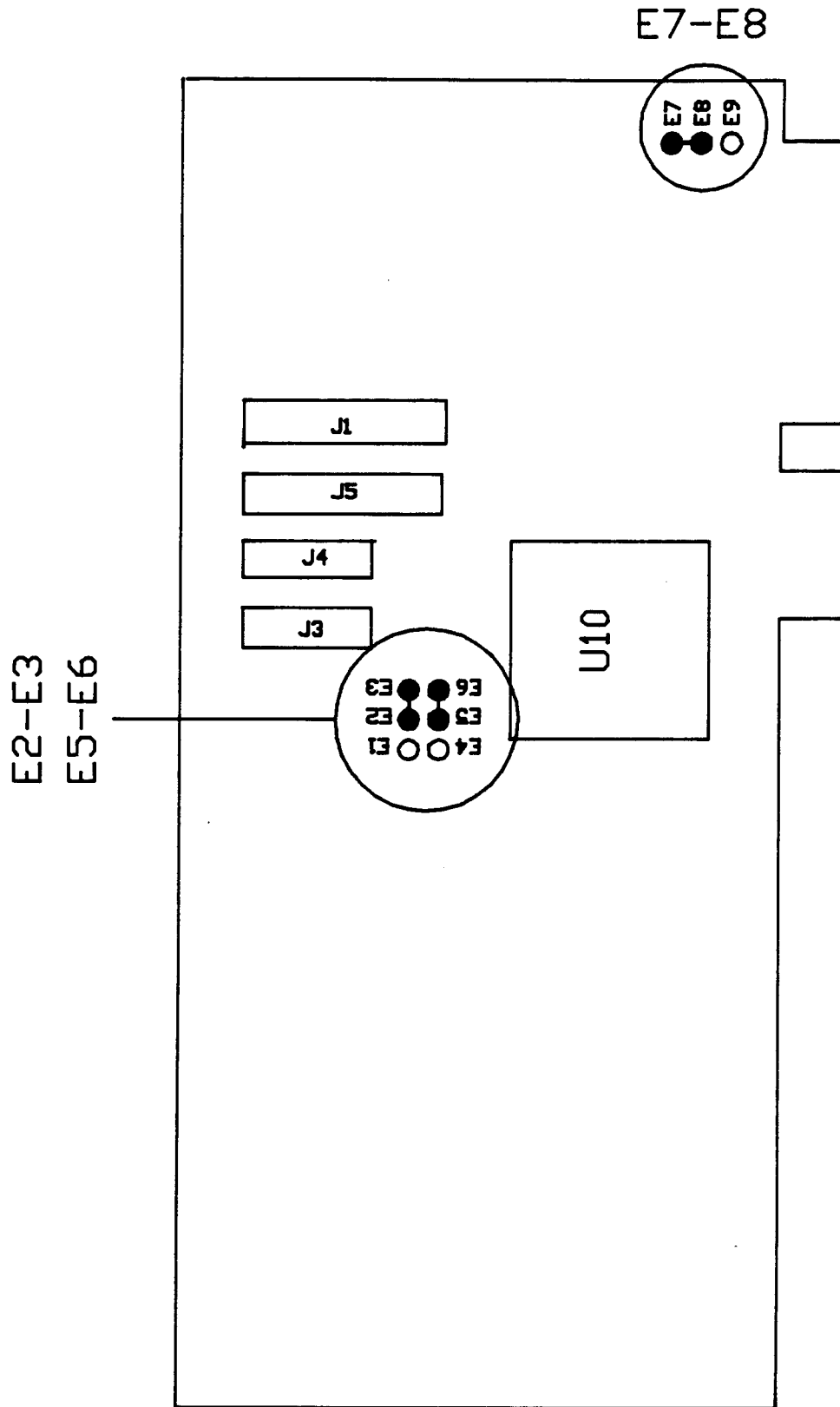

Figure 124. Floppy/Hard Drive WD1003-WA2 Controller Board.

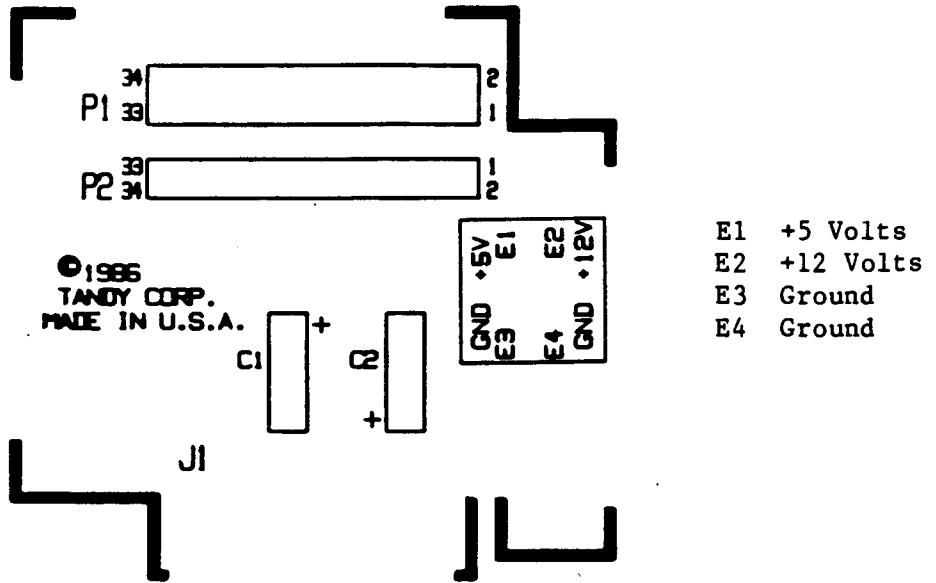

Figure 125. 1000 External Floppy Disk Interface.

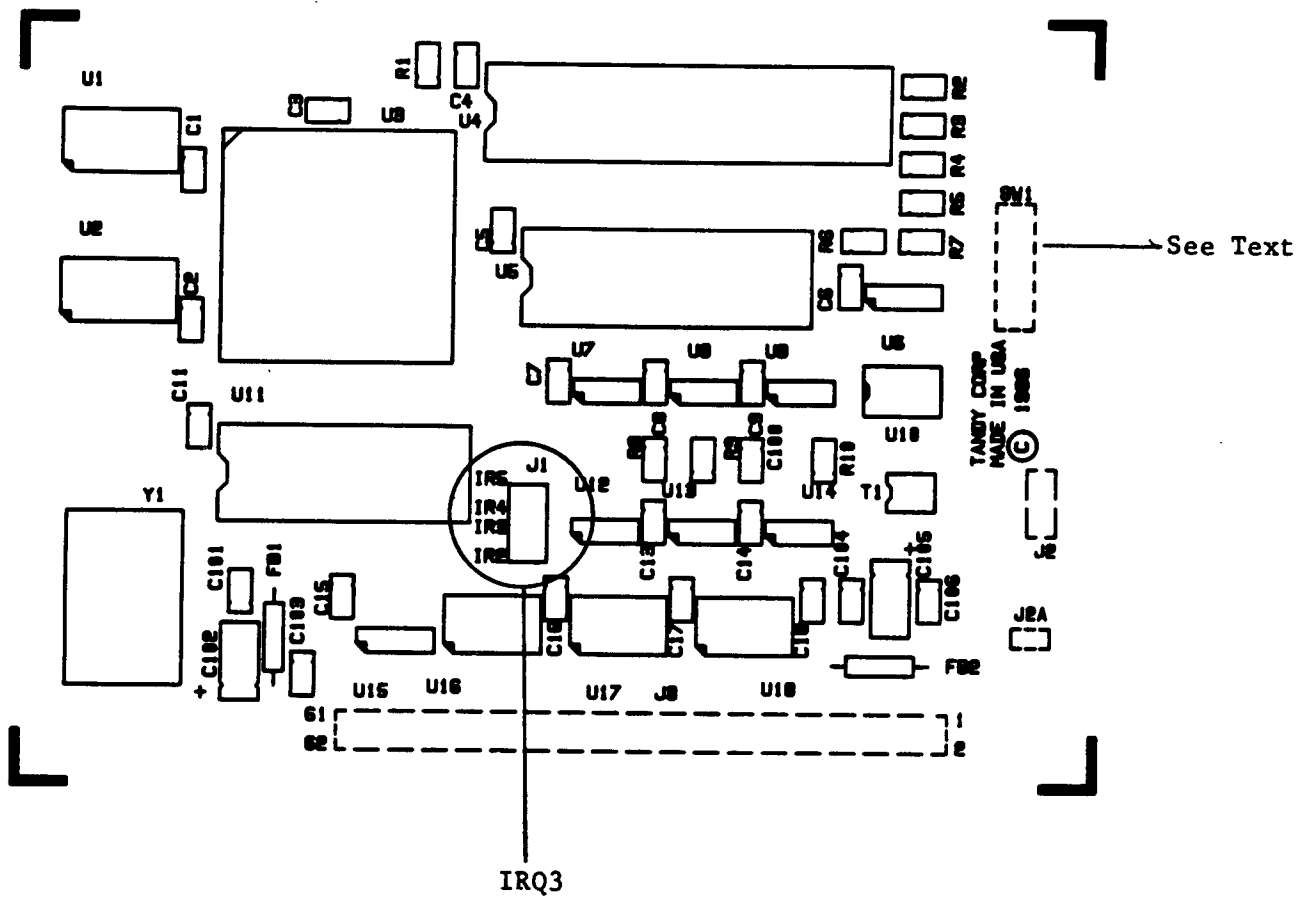
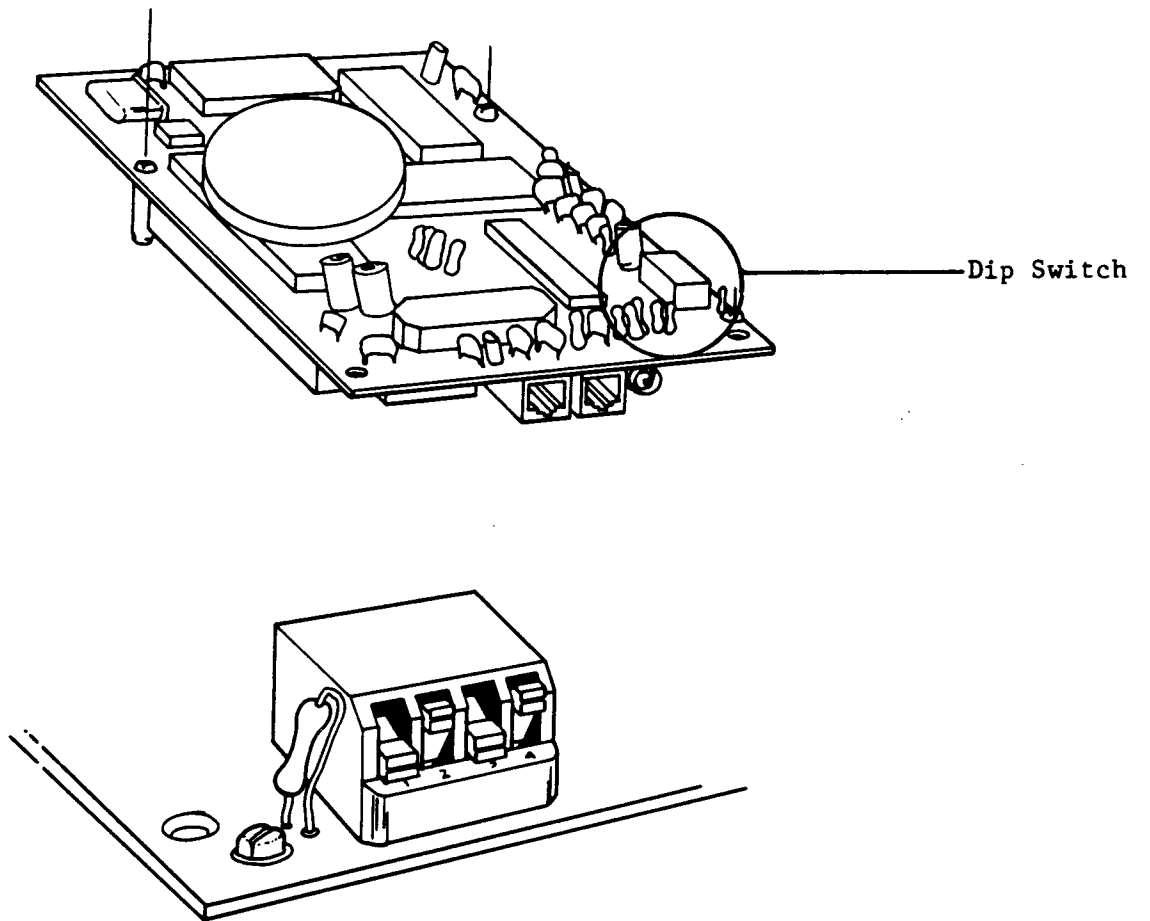

Figure 126. Plus Network 4 Interface.



See Text for proper switch settings.

Figure 127. Plus 1200 Baud Modem.

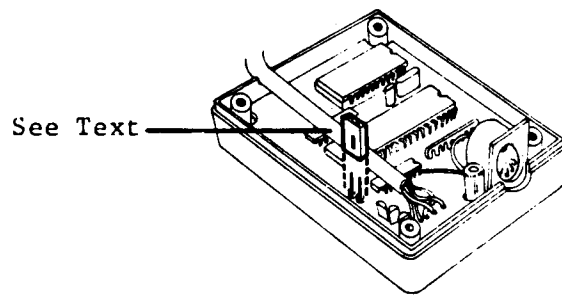

Figure 128. Enhanced Keyboard Adapter.

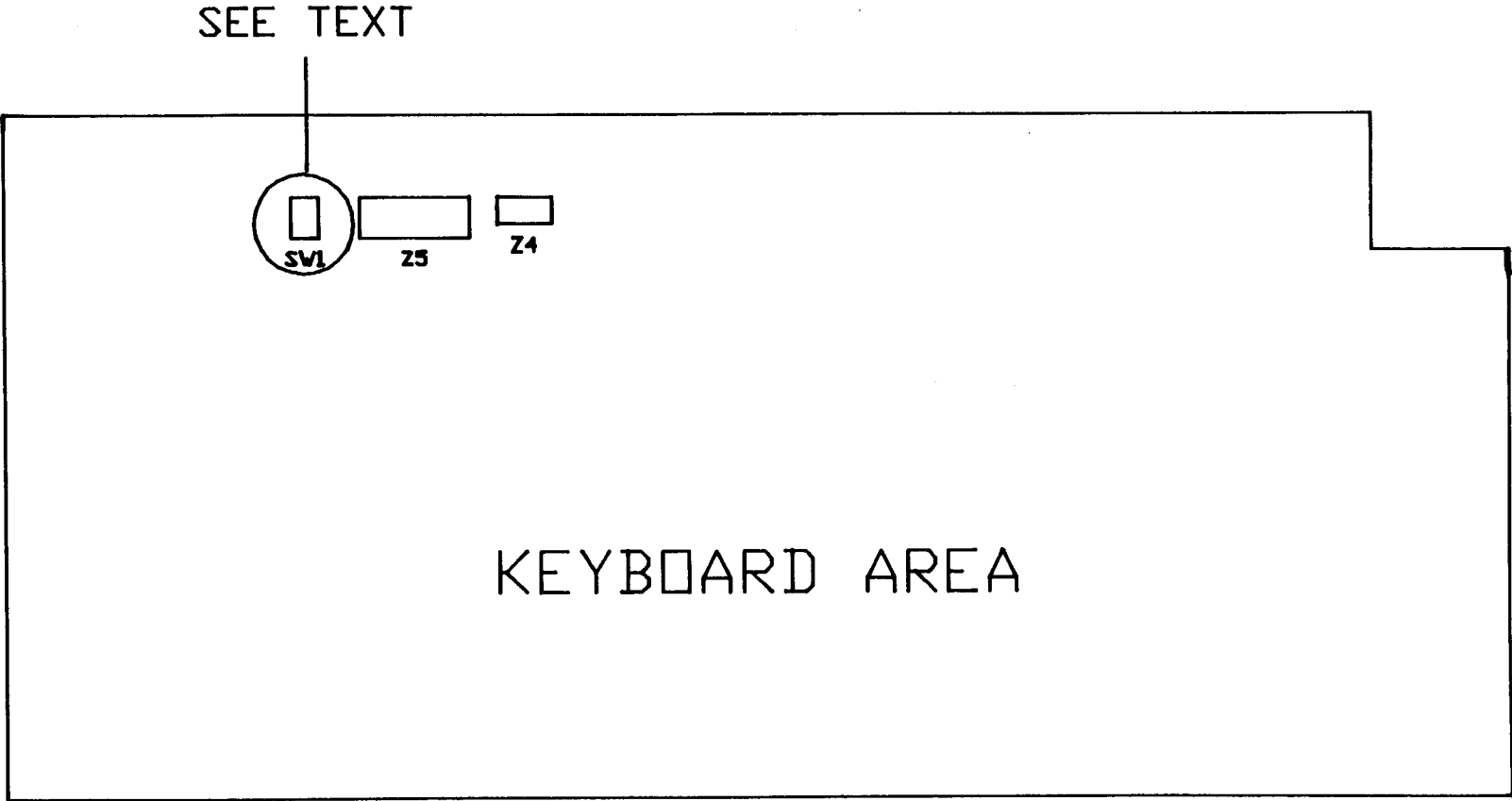
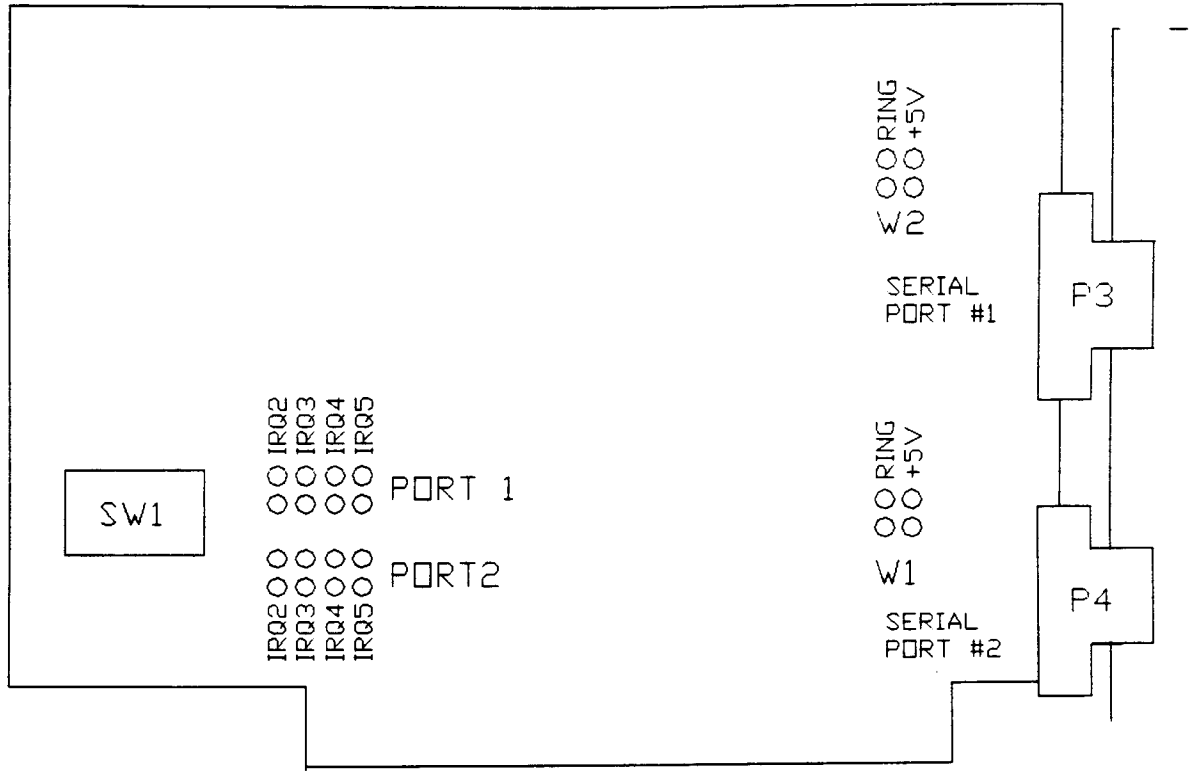

Figure 129. Enhanced Keyboard.



See text for jumper setting configurations.

Figure 130. Dual Port Serial Board

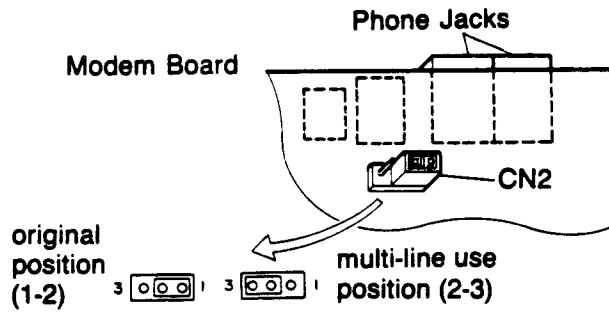
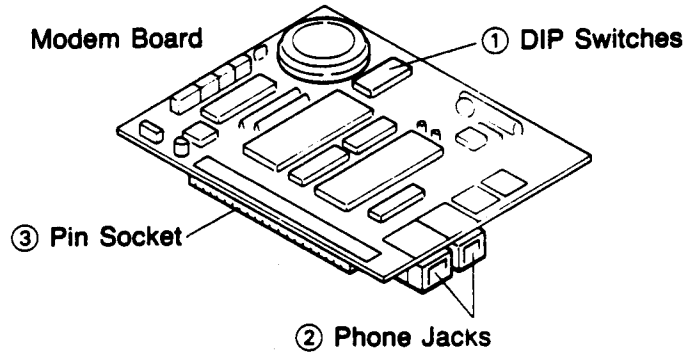

Figure 131. Plus 300 Baud Modem.

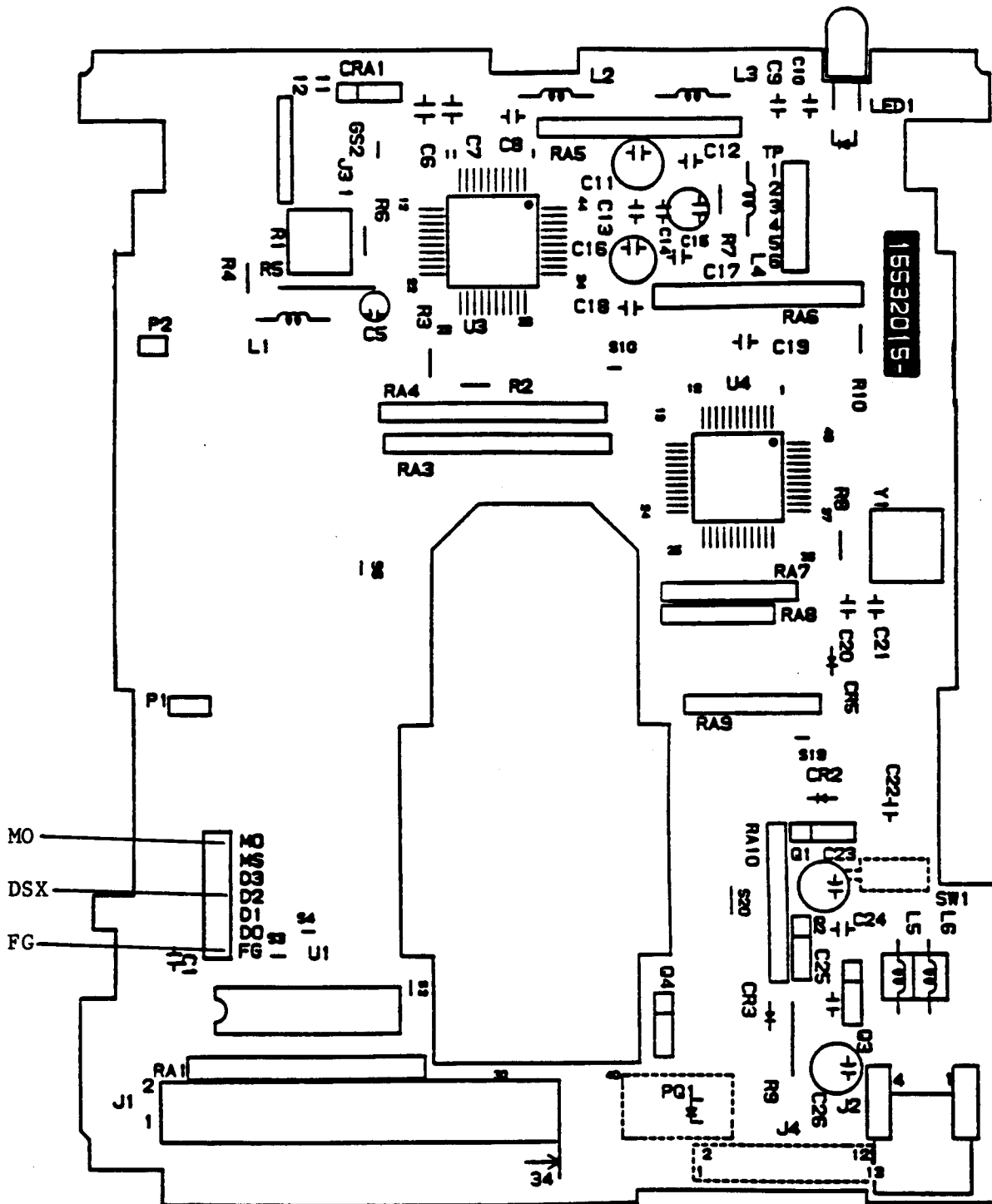

Figure 132. Teac FD-35-FN 3 1/2 Floppy Drive 720K.

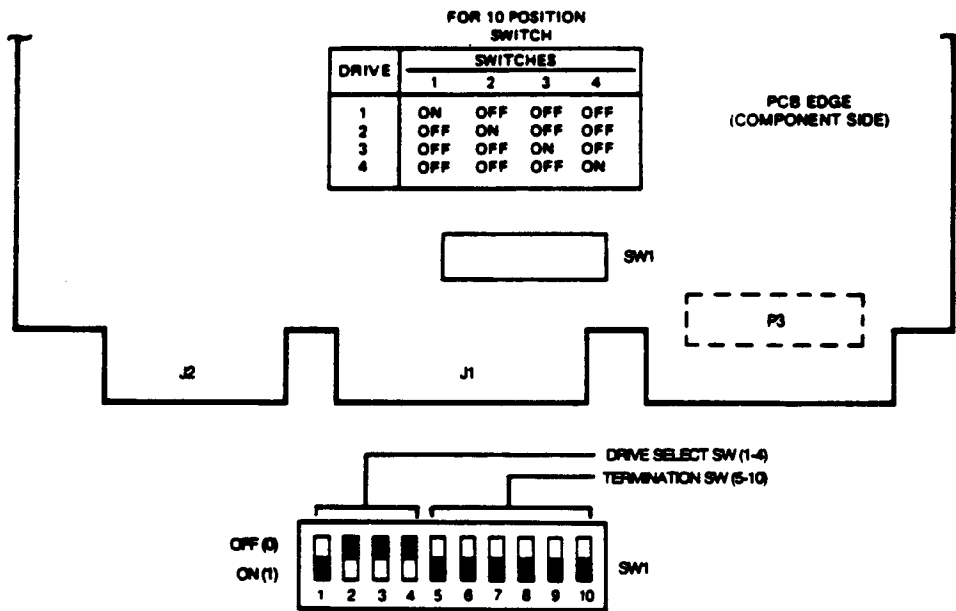
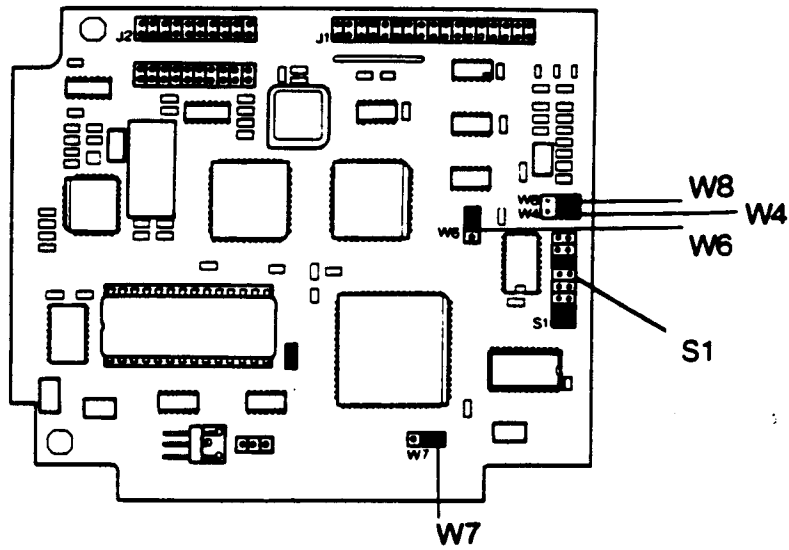

Figure 133. 40 Meg Microscience (HH-1050) Hard Drive Logic.



Note: Jumper configuration shown is for the Tandy 1000 series computer. See text for proper jumper configurations for other computers.

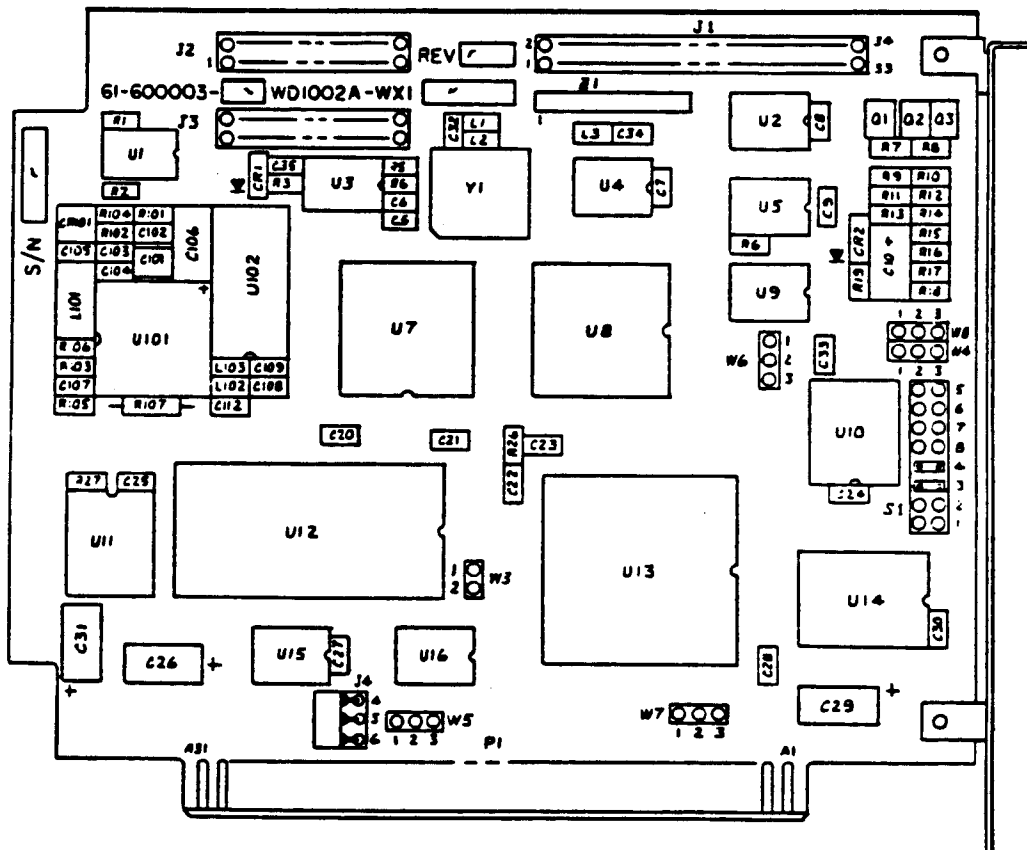

Figure 134. 20 Meg Hard Card Controller.

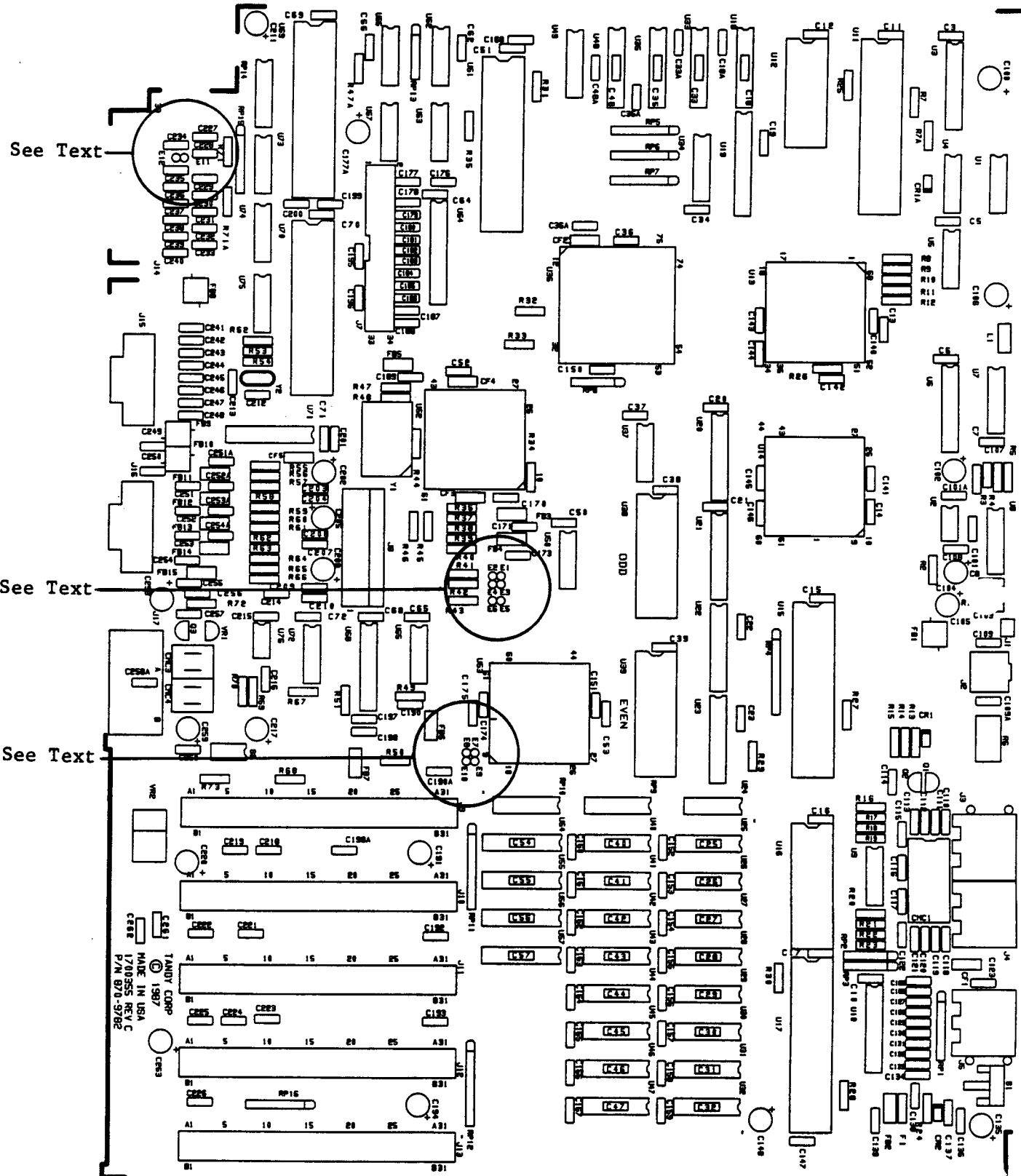

Figure 136. Tandy 1000TX Main Logic.

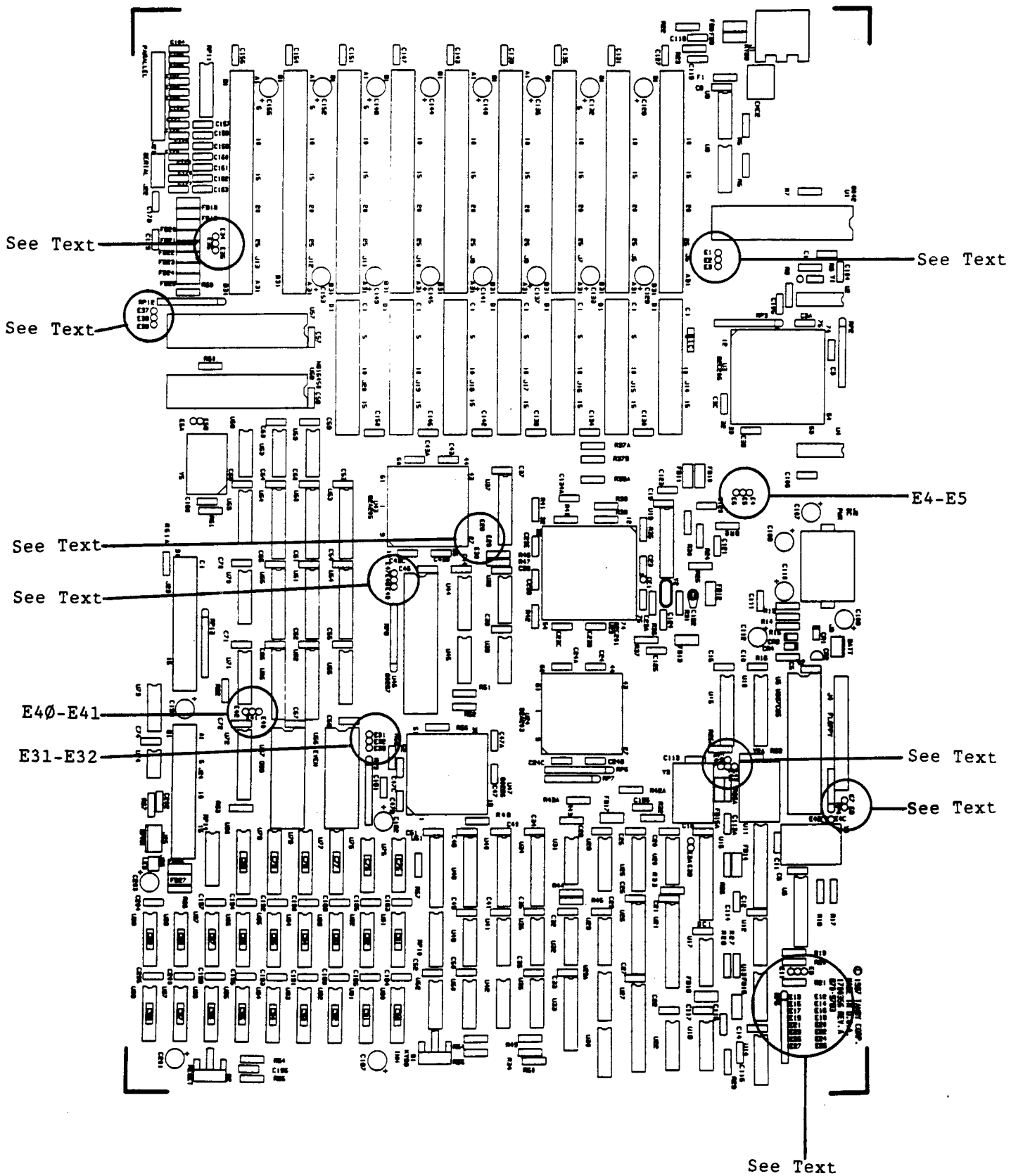

Figure 137. Tandy 3000 12MHz Main Logic Board (Rev A).

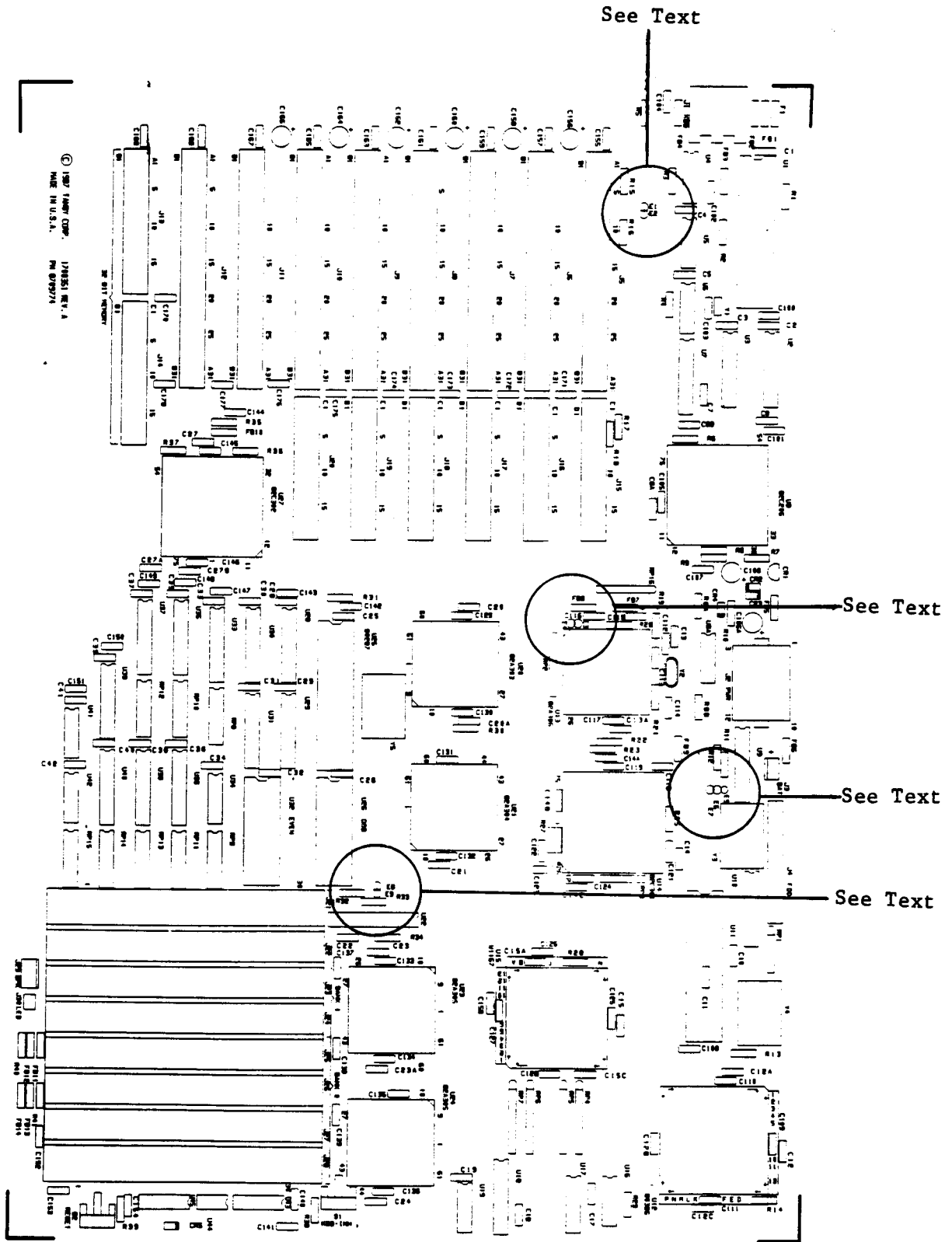

Figure 138. Tandy 4000 Main Logic.

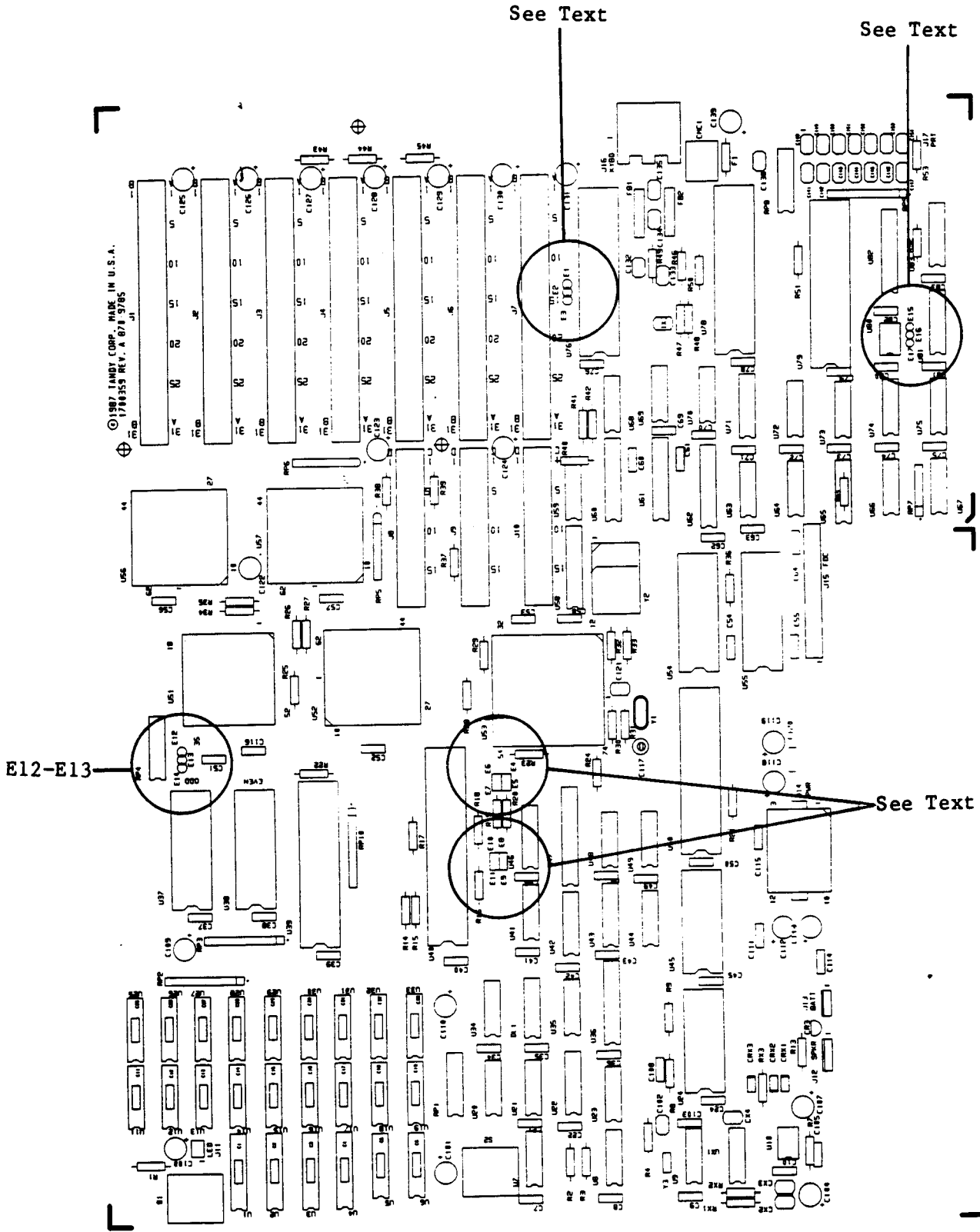
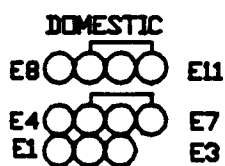
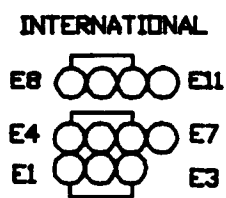
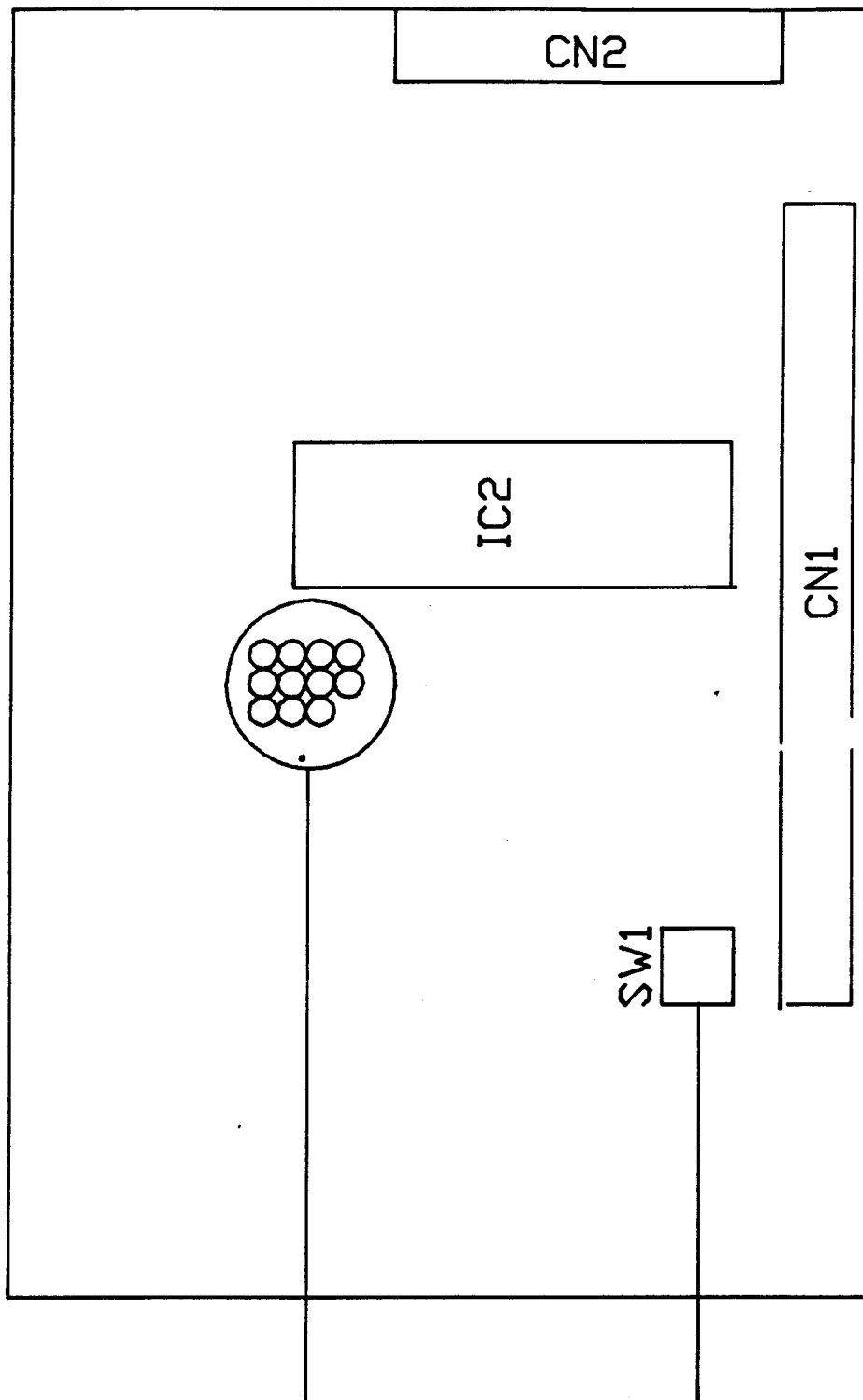

Figure 139. Tandy 3000HL with Key Lock.



SEE
TEXT

Figure 140. Plus RS232.

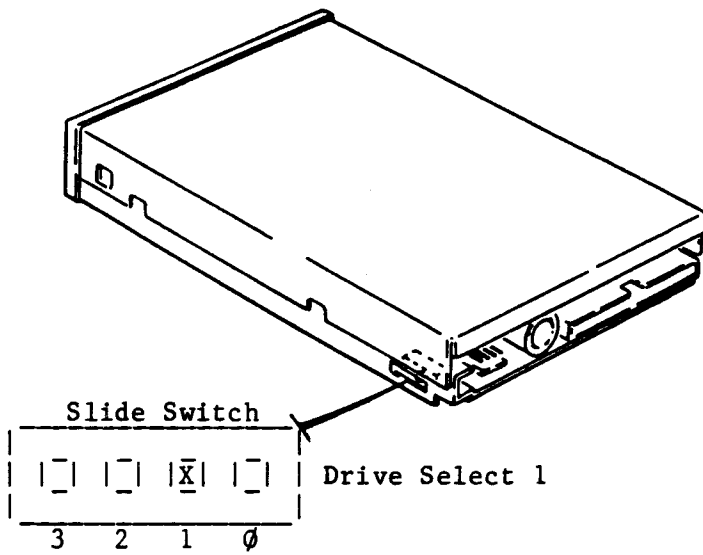

Figure 141.

Sony MP-F73W- \emptyset 1D	1.44M	3 1/2"	Floppy Drive
Sony MP-F73W-7 \emptyset D	1.44M	3 1/2"	Floppy Drive
Sony MP-F17W-7 \emptyset D	1.44M	3 1/2"	Floppy Drive
Sony MP-F17W-71	1.44M	3 1/2"	Floppy Drive
Sony MP-F17W-72	1.44M	3 1/2"	Floppy Drive

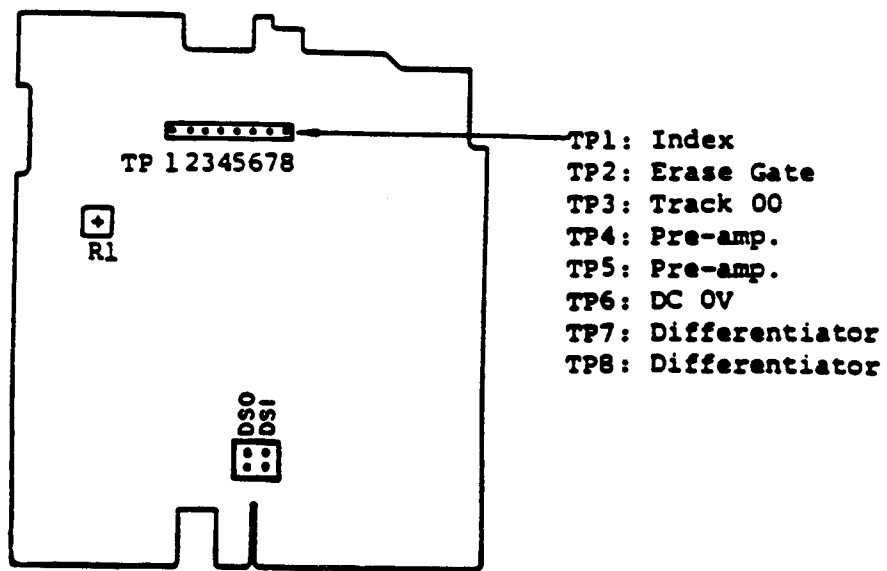

Figure 142. Teac 5 1/4 Floppy FD55BV-221.

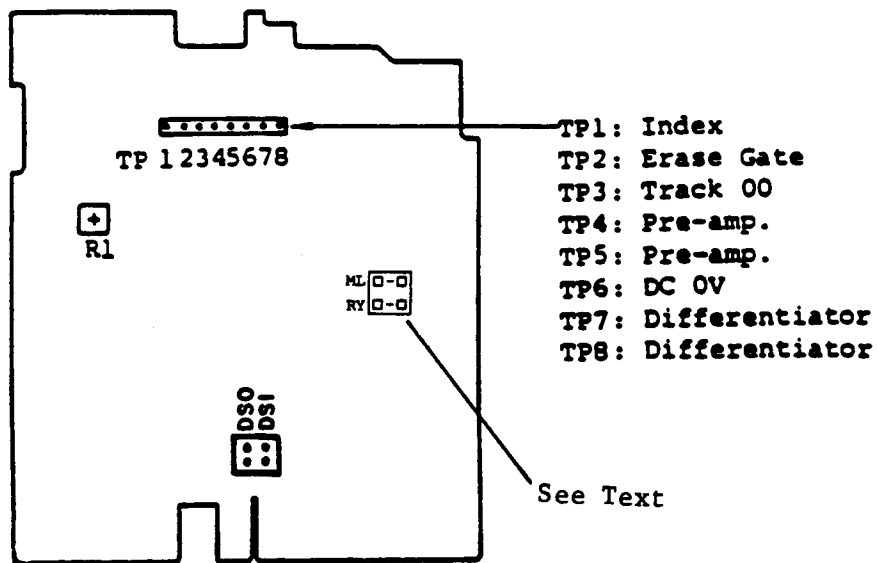

Figure 143. Teac 5 1/4 Floppy FD55BR-521

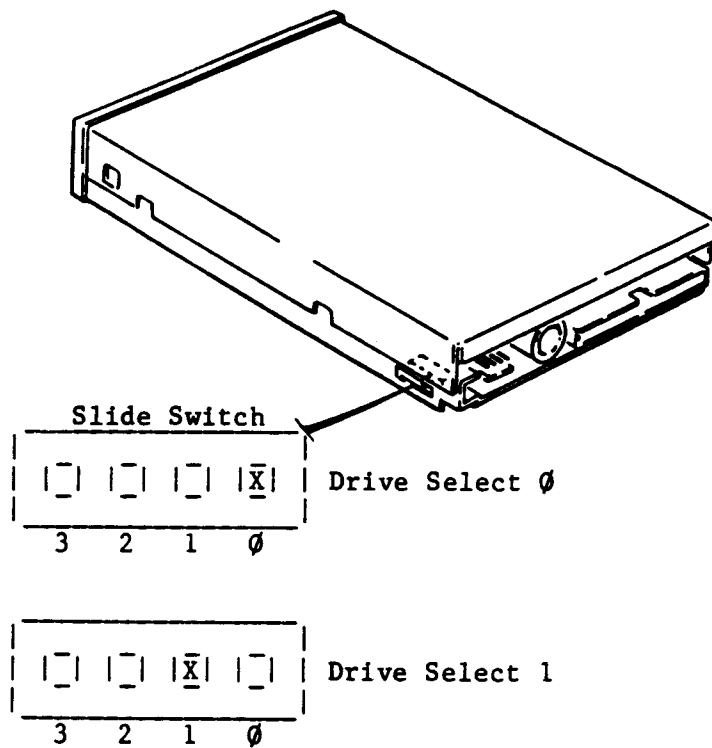
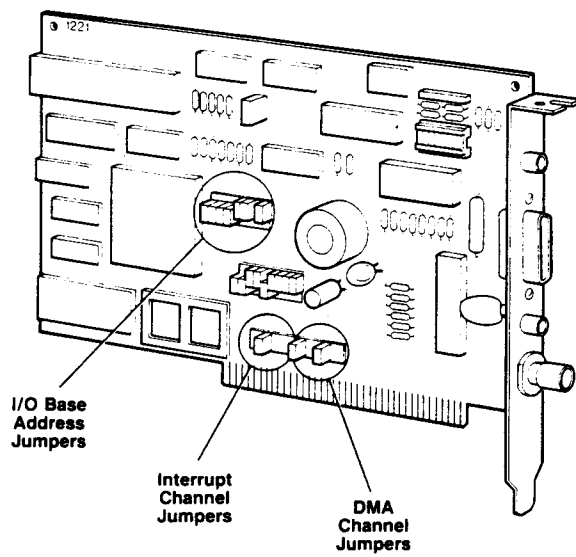

Figure 144.

Sony MP-F63W-01D	720K	3 1/2"	Floppy Drive
Sony MP-F63W-70D	720K	3 1/2"	Floppy Drive
Sony MP-F11W-70D	720K	3 1/2"	Floppy Drive
Sony MP-F11W-71	720K	3 1/2"	Floppy Drive
Sony MP-F11W-72	720K	3 1/2"	Floppy Drive



Note: See text for proper jumper configurations.

Figure 145. Original Style Etherlink I Adapter Board

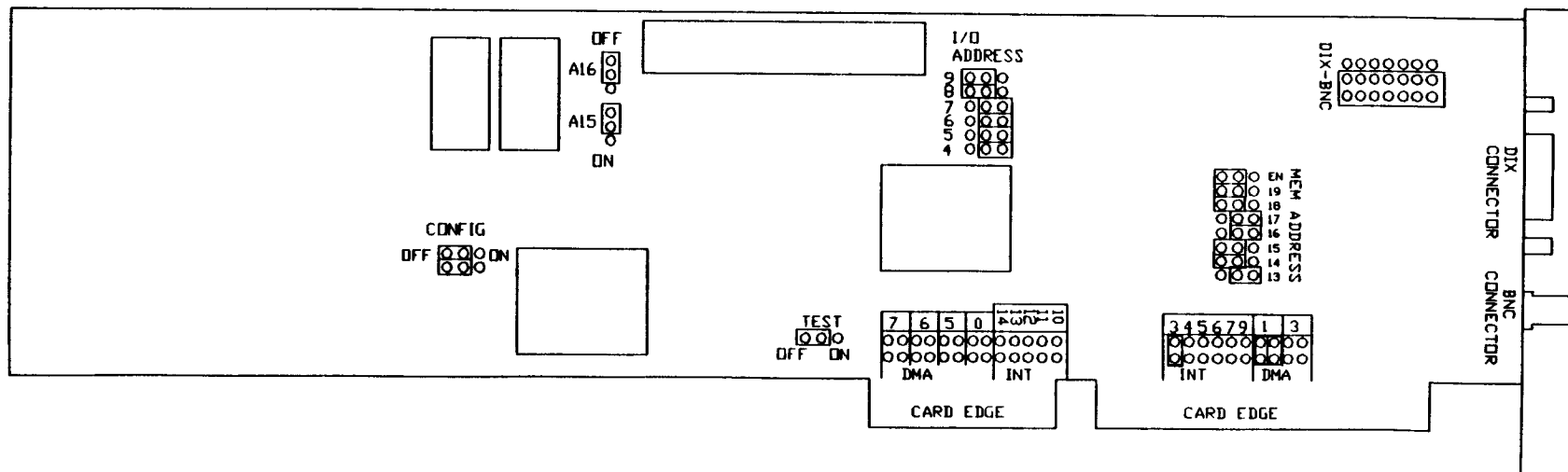
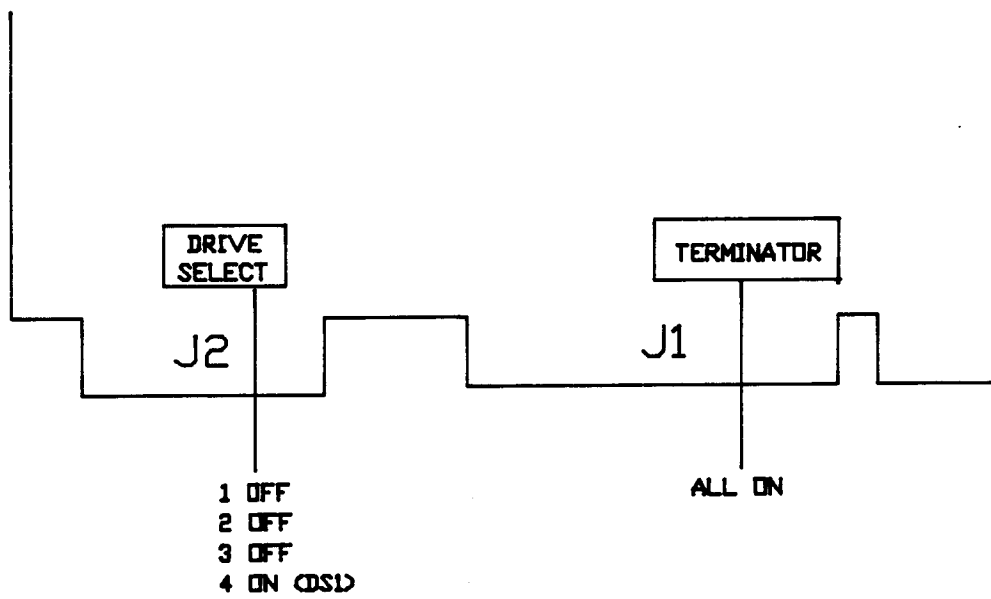

Figure 146. Etherlink PLUS Adapter Board

STYLE 1



STYLE 2

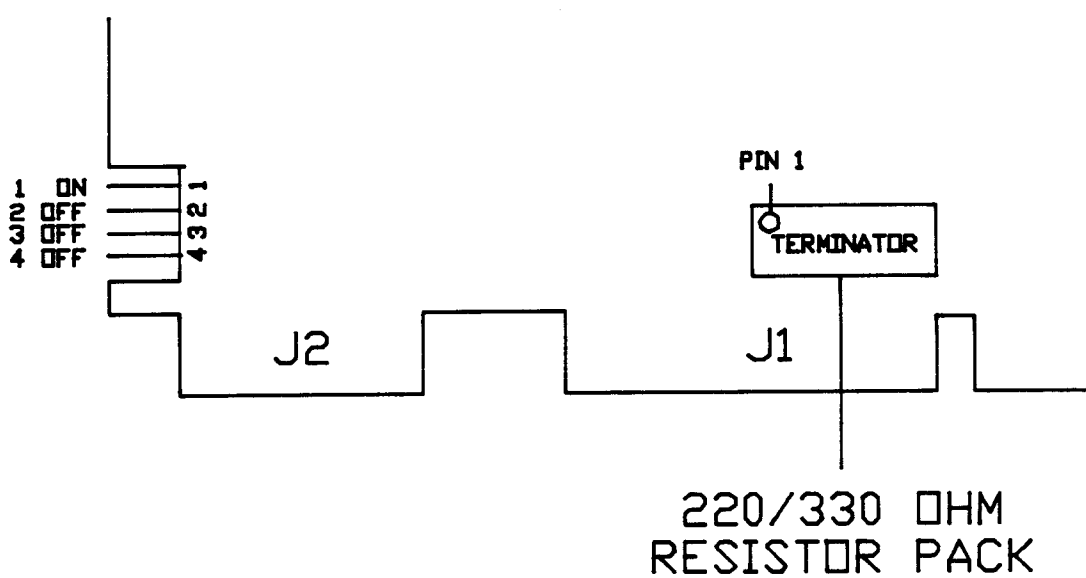
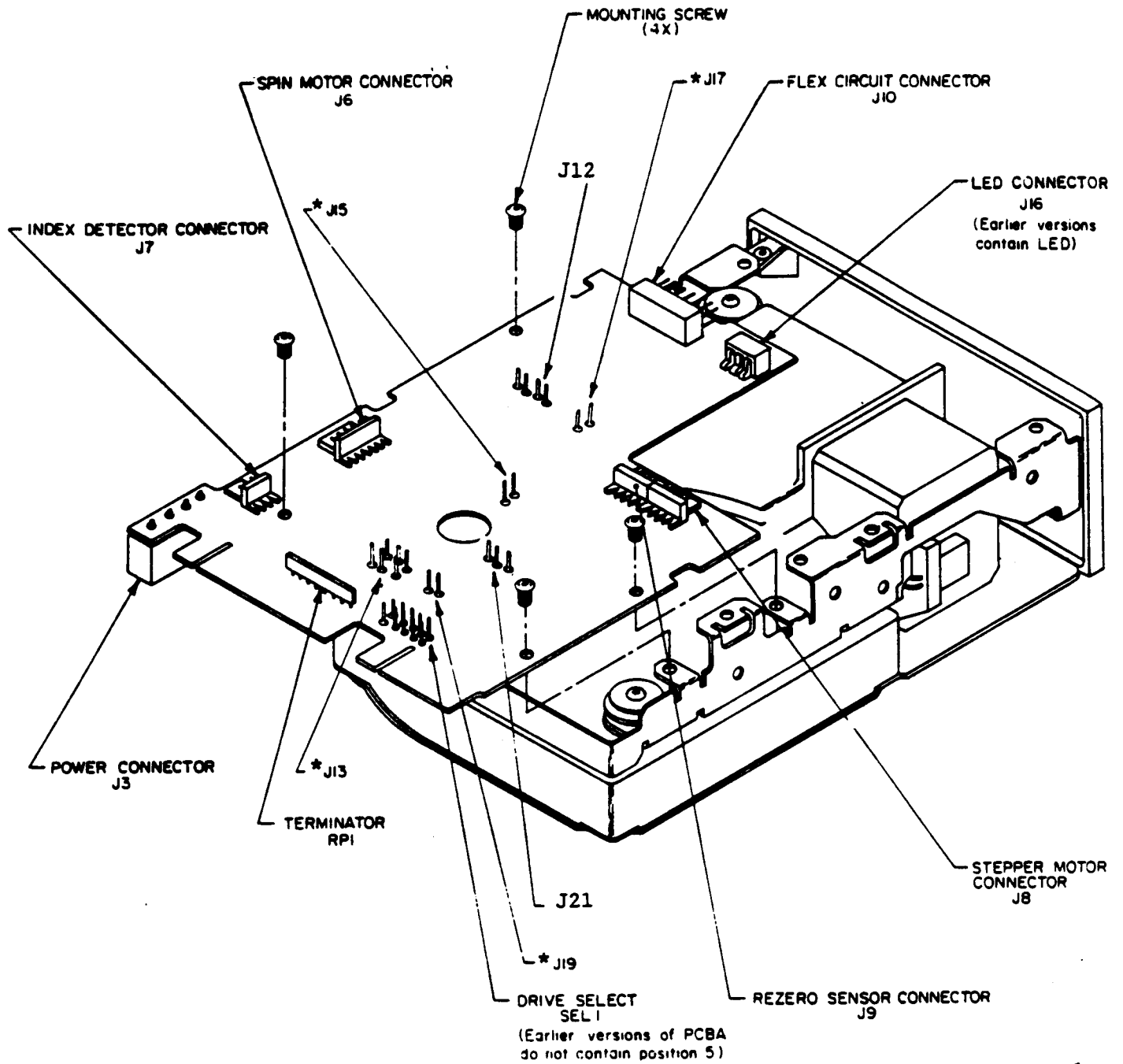

Figure 147. 20 Meg Fuji (FK 302-26/305-26) HD Logic.



* Earlier versions of PCBA do not contain these jumpers.

Figure 148. 20 MEG MiniScribe 8438 Hard Card
Version 2

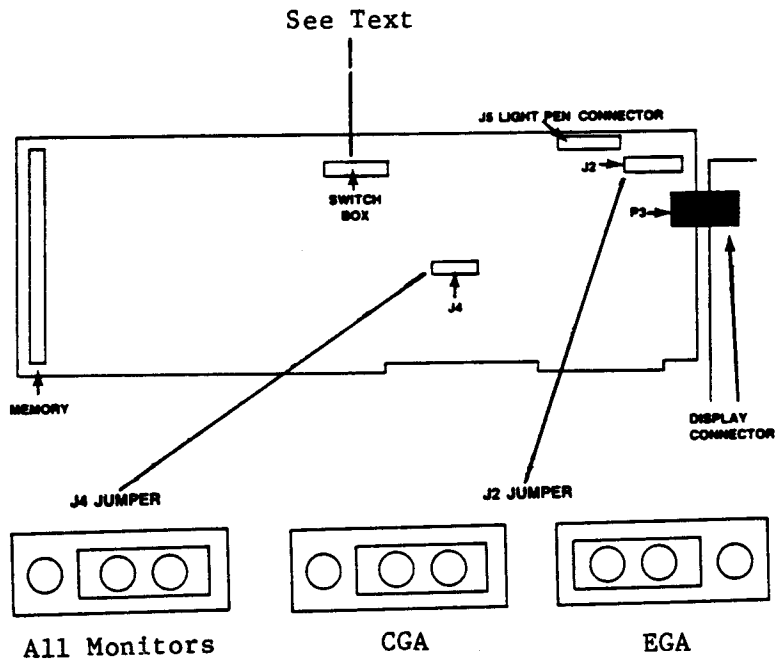

Figure 149. EGA Monitor Board.

OPTION SWITCH ASSIGNMENTS

S1	OFF	=	MANUAL POWER-ON RESET (MUST BE SWITCHED OFF FOR SYSTEM TO OPERATE)
S2	OFF	=	NORMAL OPERATION
	ON	=	DIAGNOSTIC OPERATIONS
S3	OFF	=	NO PARITY CHECKING
	ON	=	PARITY CHECKING
S4	S5	S6	SCSI BUS ADDRESS
OFF	OFF	OFF	0
OFF	OFF	ON	1
OFF	ON	OFF	2
OFF	ON	ON	3
ON	OFF	OFF	4
ON	OFF	ON	5
ON	ON	OFF	6
ON	ON	ON	7

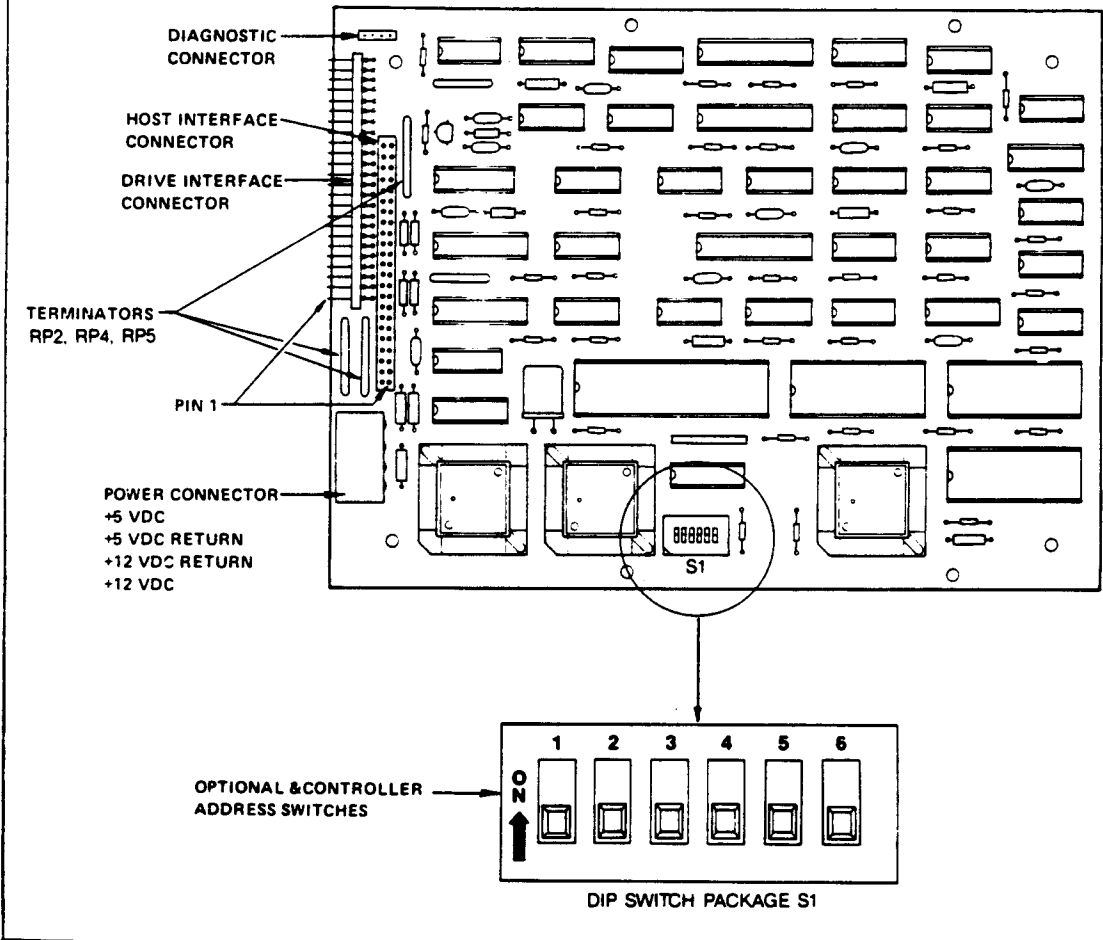

Figure 150. Controller for I/O Mega Beta 20.

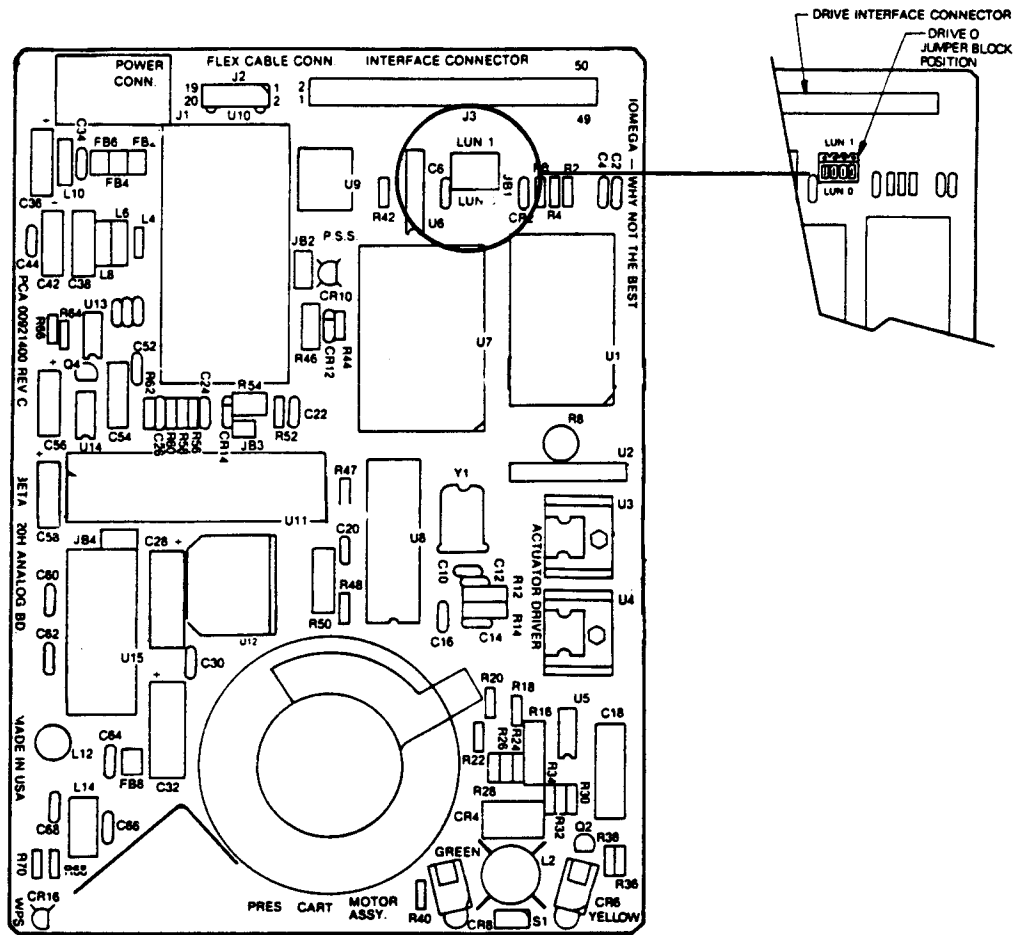

Figure 151. 20 Meg IO Mega (Beta 20) Primary.

Drawing of Secondary Drive Logic Board not available.

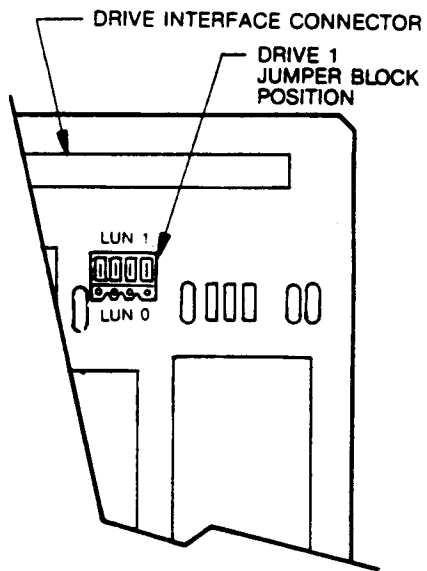

Figure 152. 20 Meg IO Mega (Beta 20) Secondary.

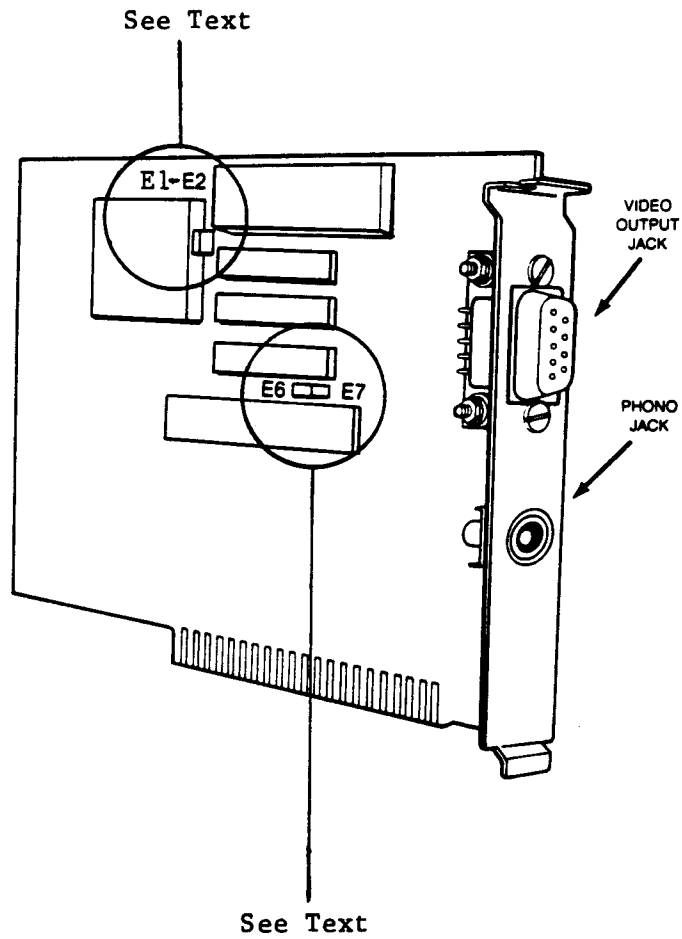

Figure 153. Dual Display Graphics Adapter.

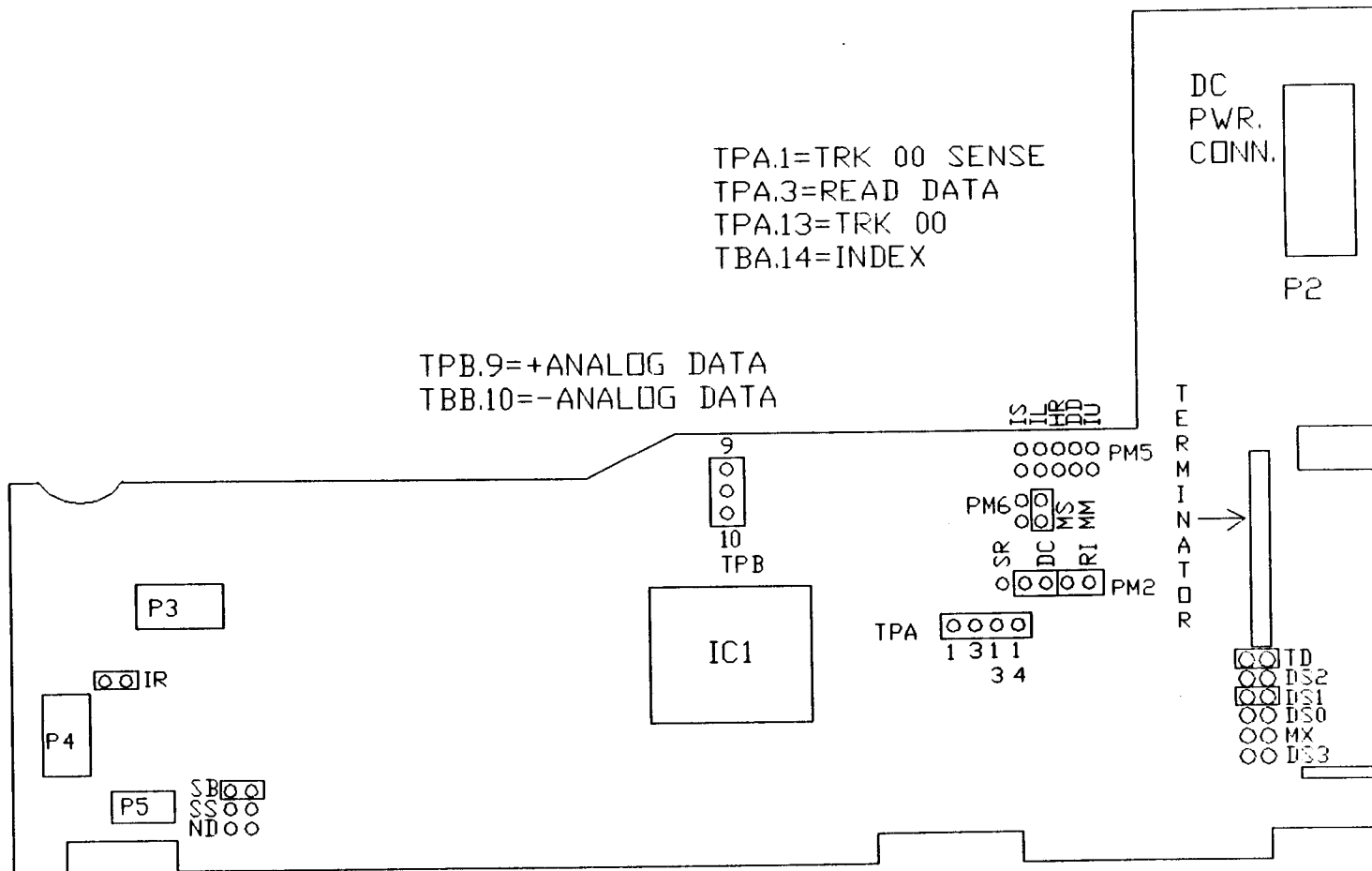
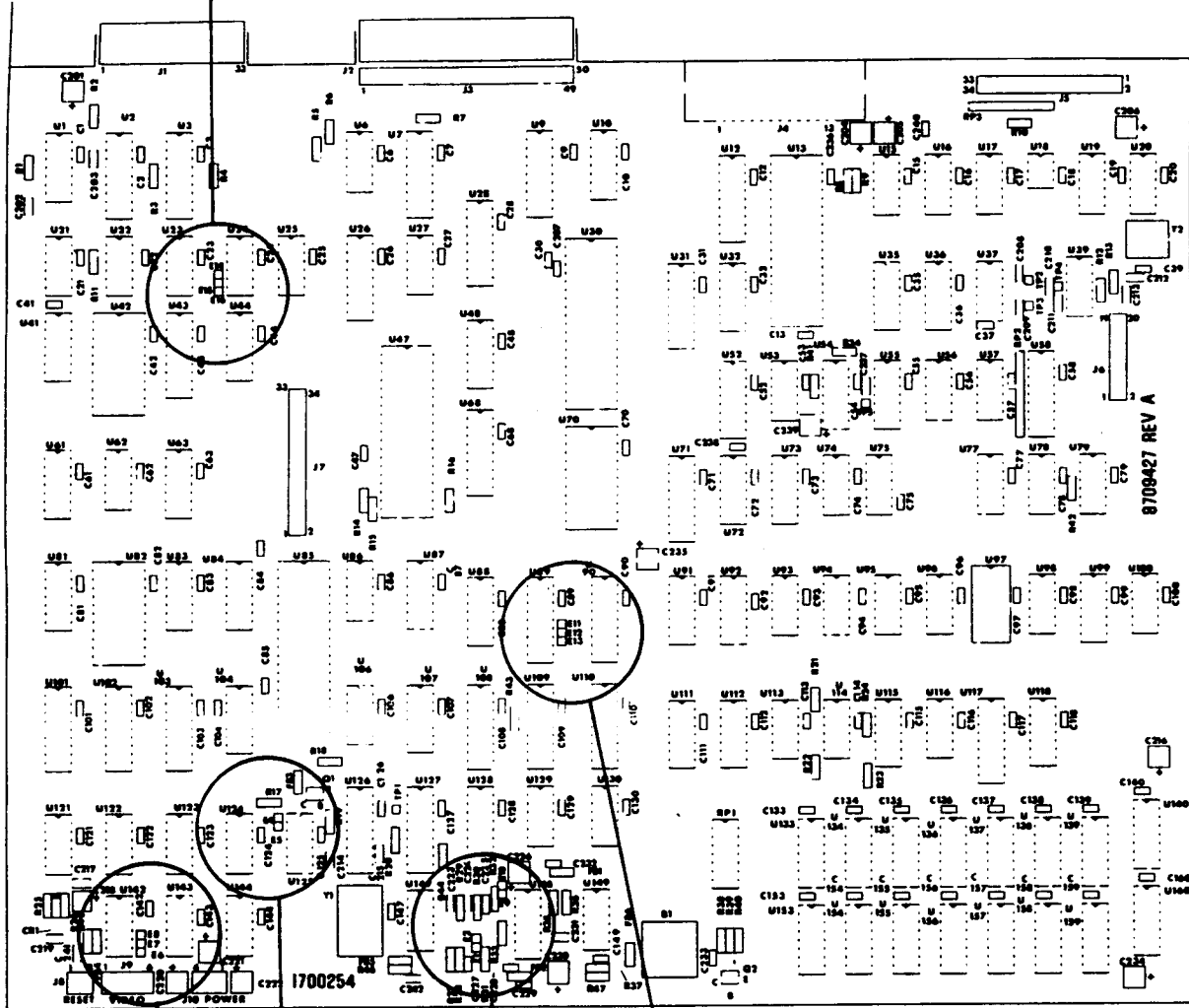

Figure 154. Mitsubishi MF504B Floppy Drive Logic Board

E14-15



E6-E7 See Text

E1-E2 See Text

Figure 155. Model 4P Standard Main Logic Board.

TANDY CORP

8709524 REV --

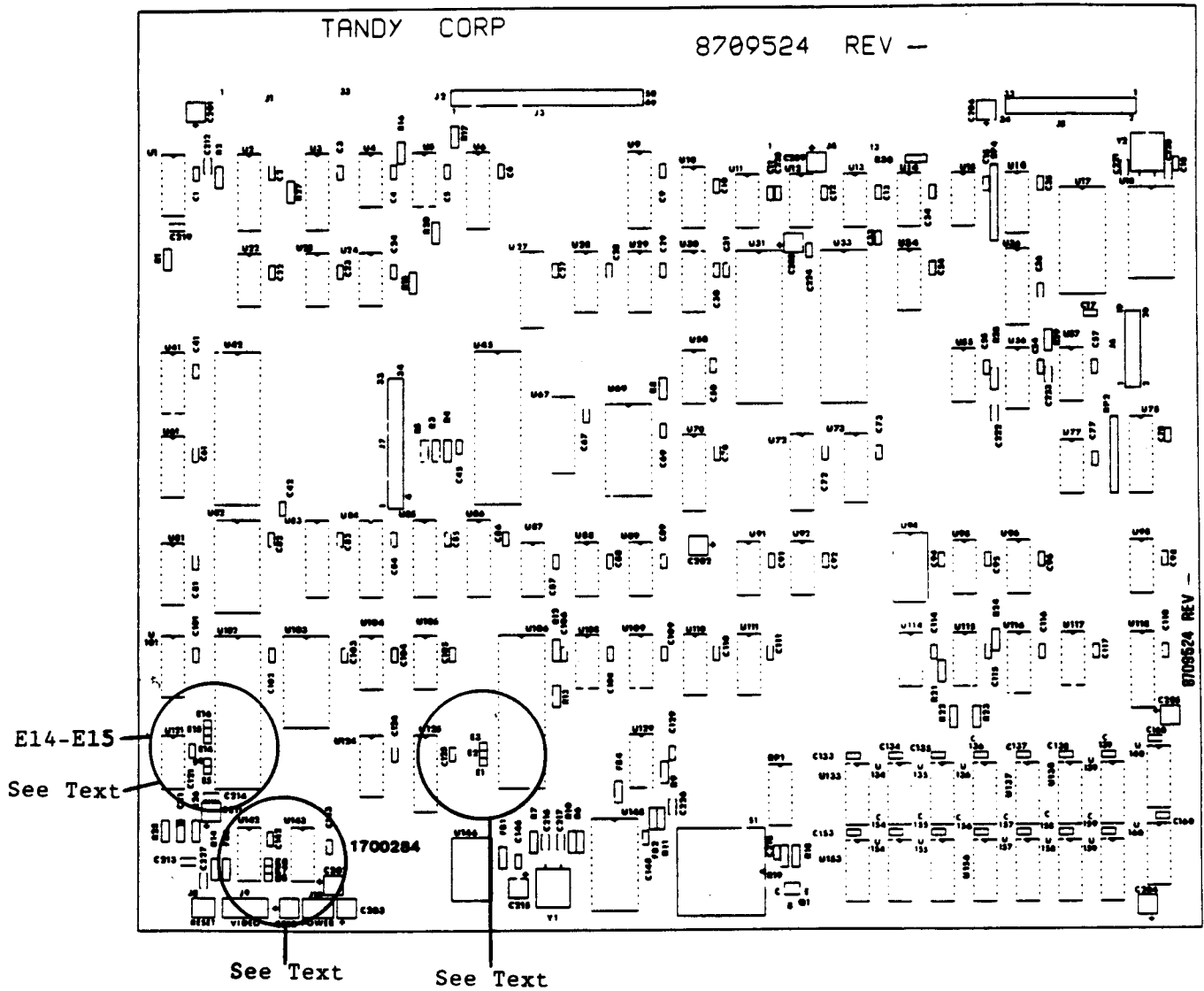

Figure 156. Model 4P Gate Array Main Logic Board

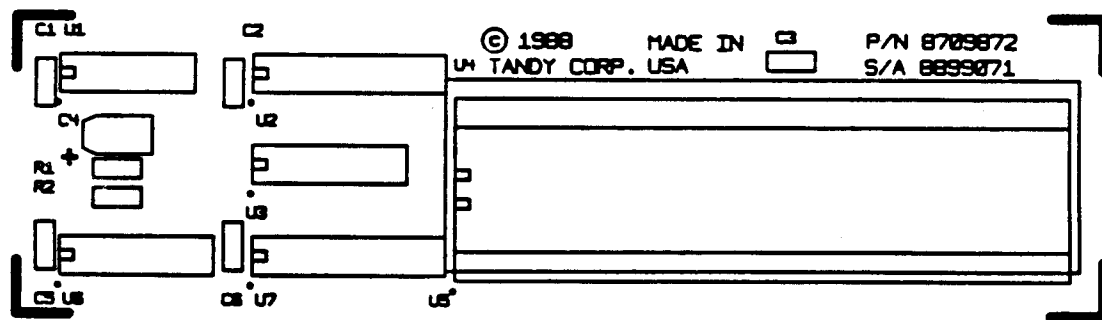

Figure 157. 68000 MMU Board

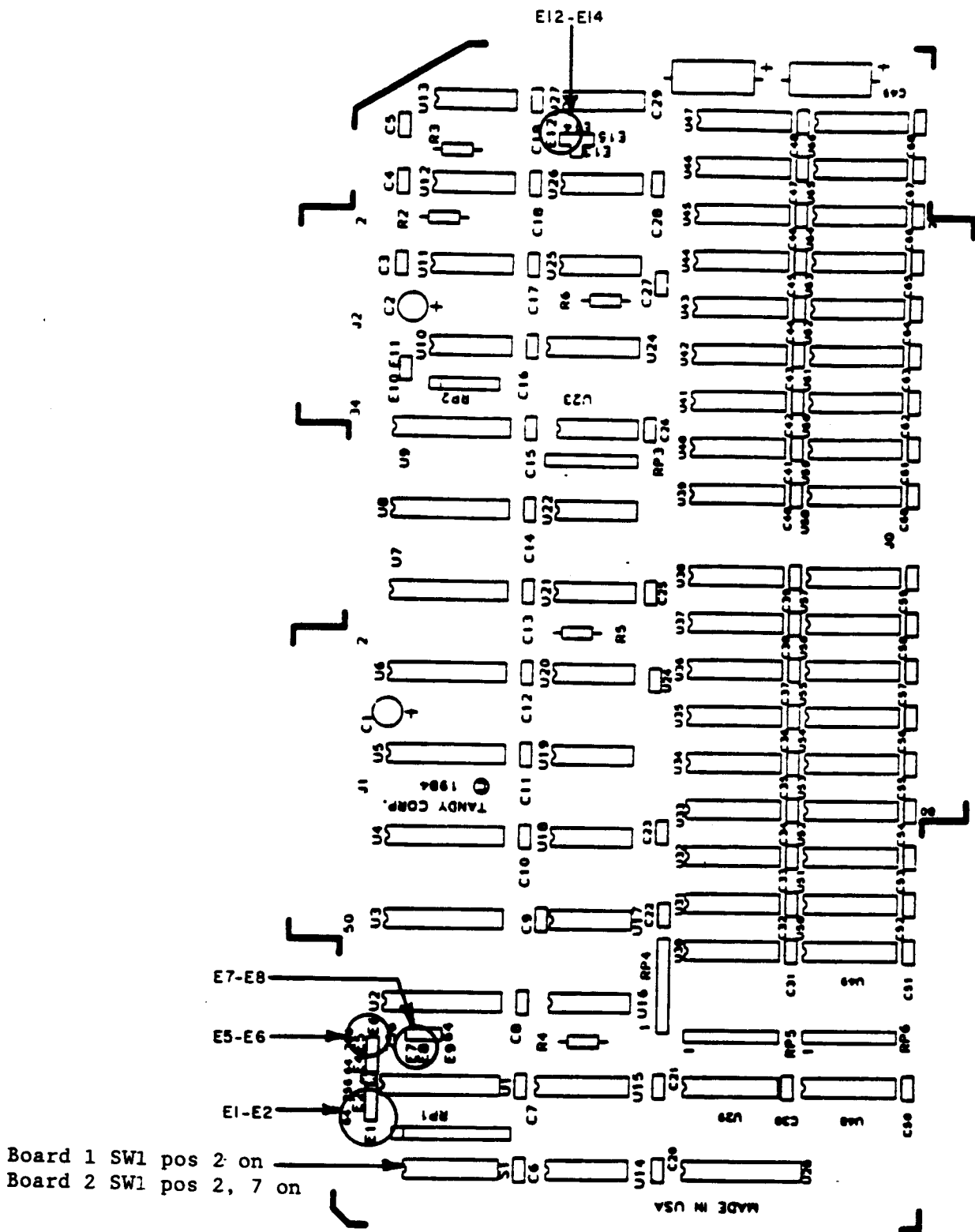

Figure 158. 512K/1MEG 68000 Memory Board With 512K

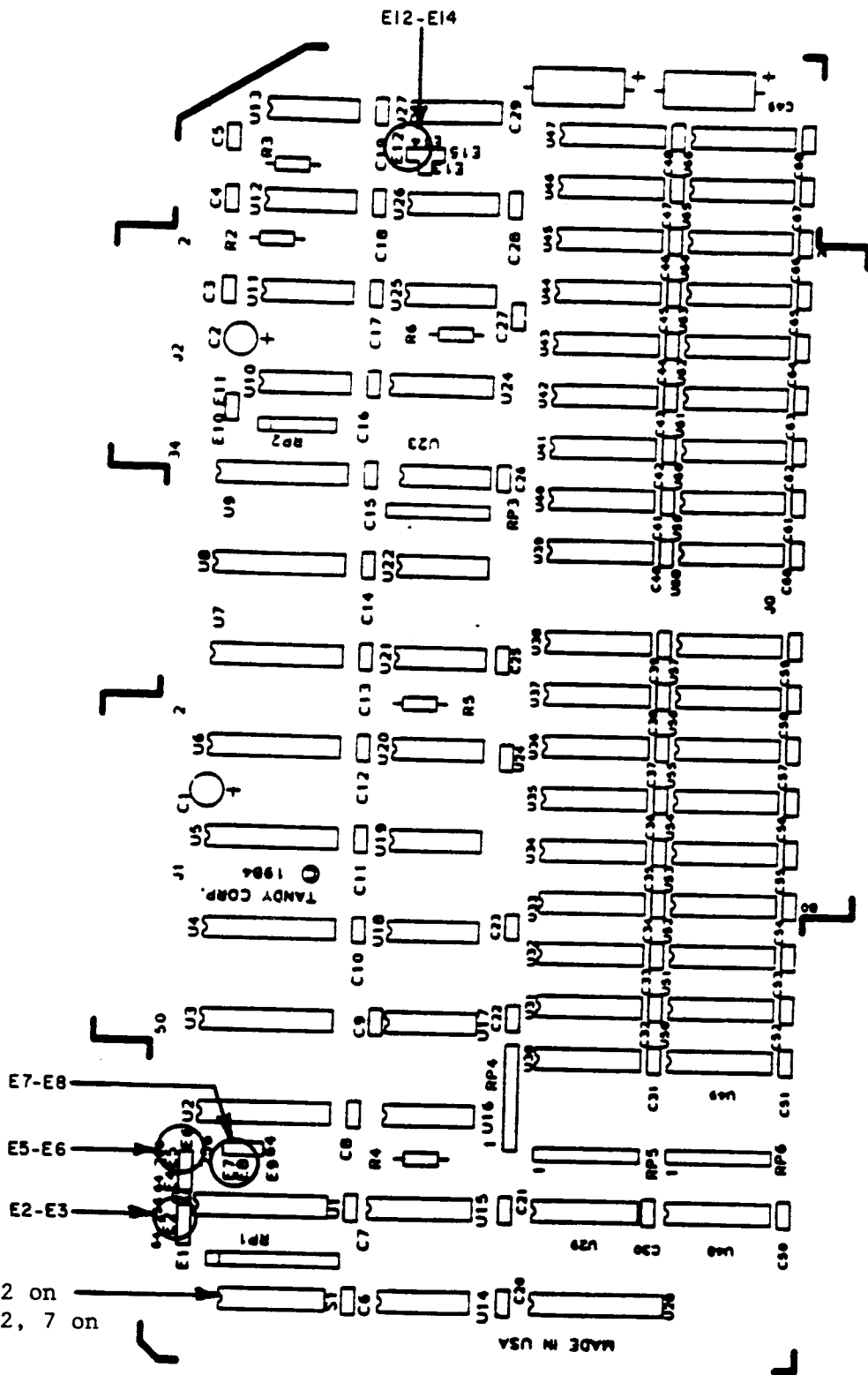

Figure 159. 512K/1MEG 68000 Memory Board With 1MEG

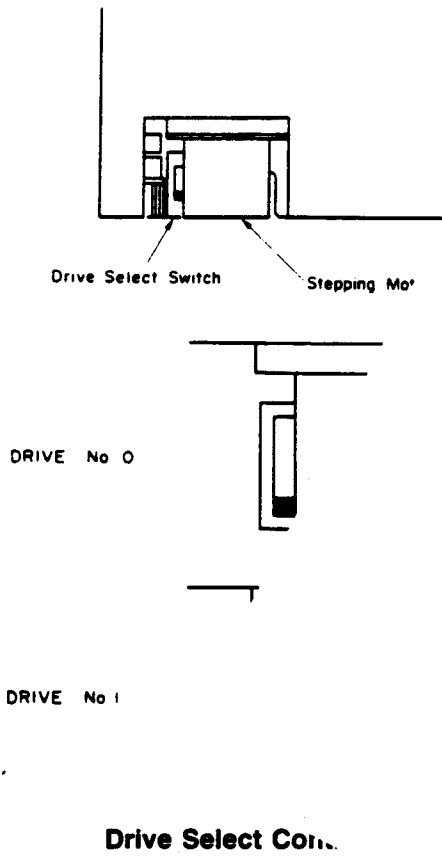

Figure 160. Citizen OSDC-95A 3 1/2" Floppy Drive 720K

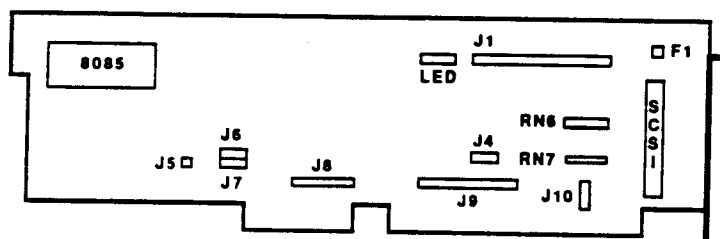

Figure 161. 16 bit SCSI Hard Drive Interface

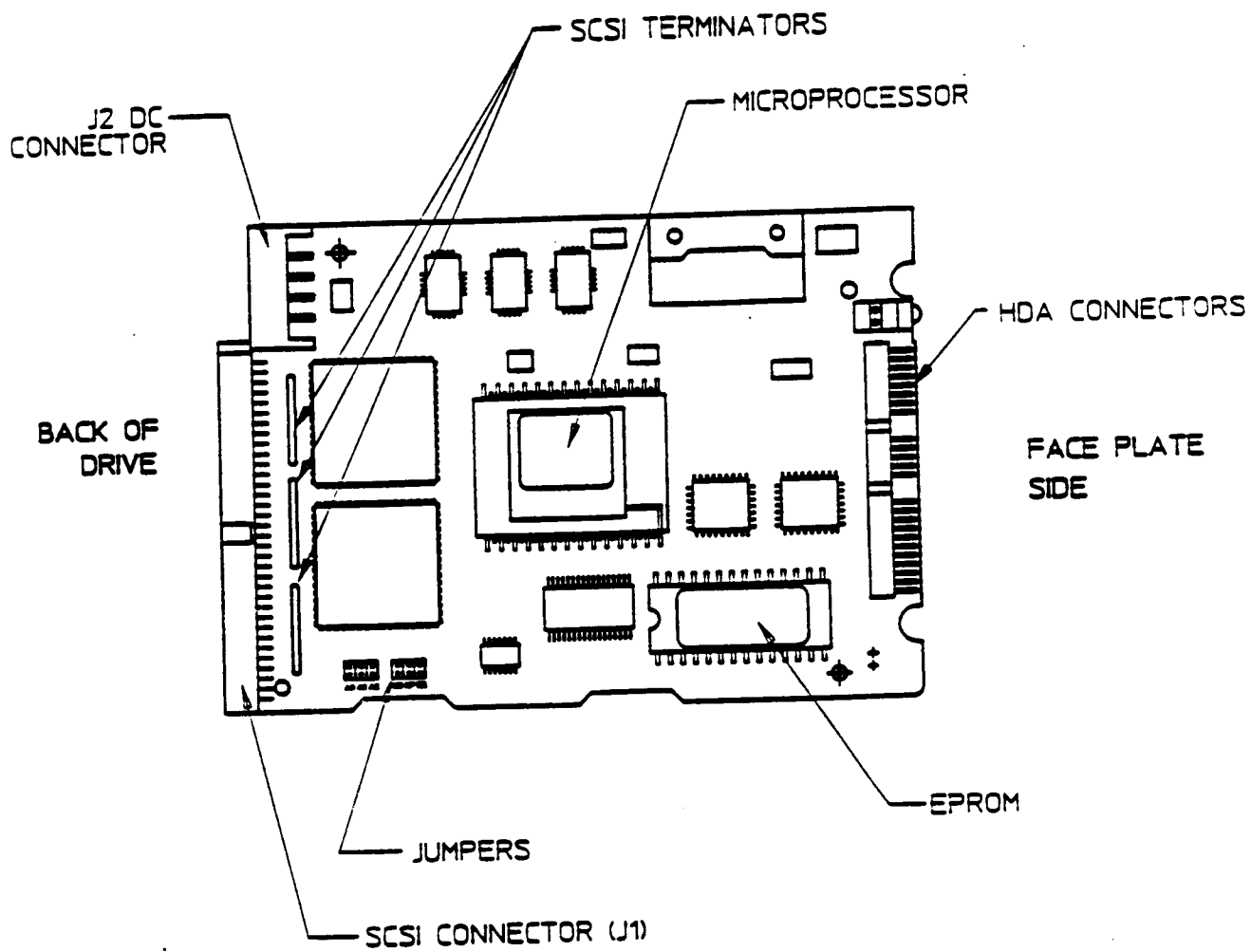

Figure 162. 40 MEG Quantum 3 1/2" SCSI Hard Drive
 80 MEG Quantum 3 1/2" SCSI Hard Drive

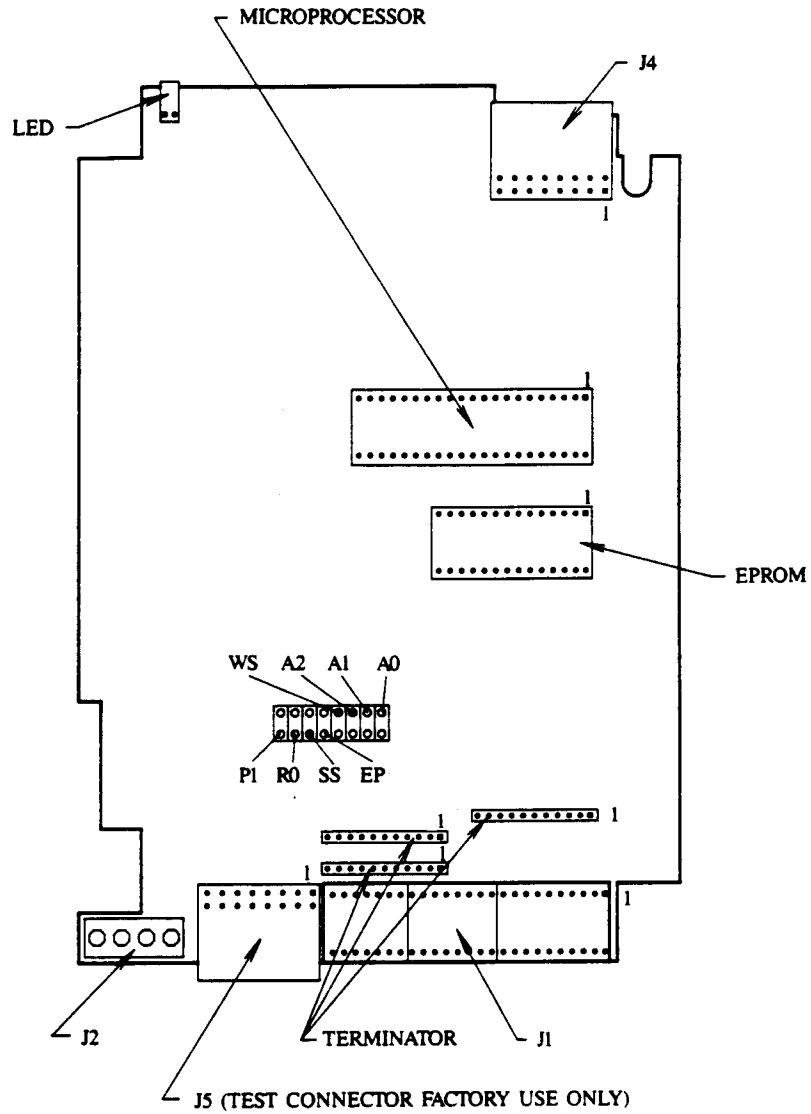

Figure 163. 80 MEG Quantum 5 1/4" SCSI Hard Drive

REAR VIEW OF DRIVE MECHANISM

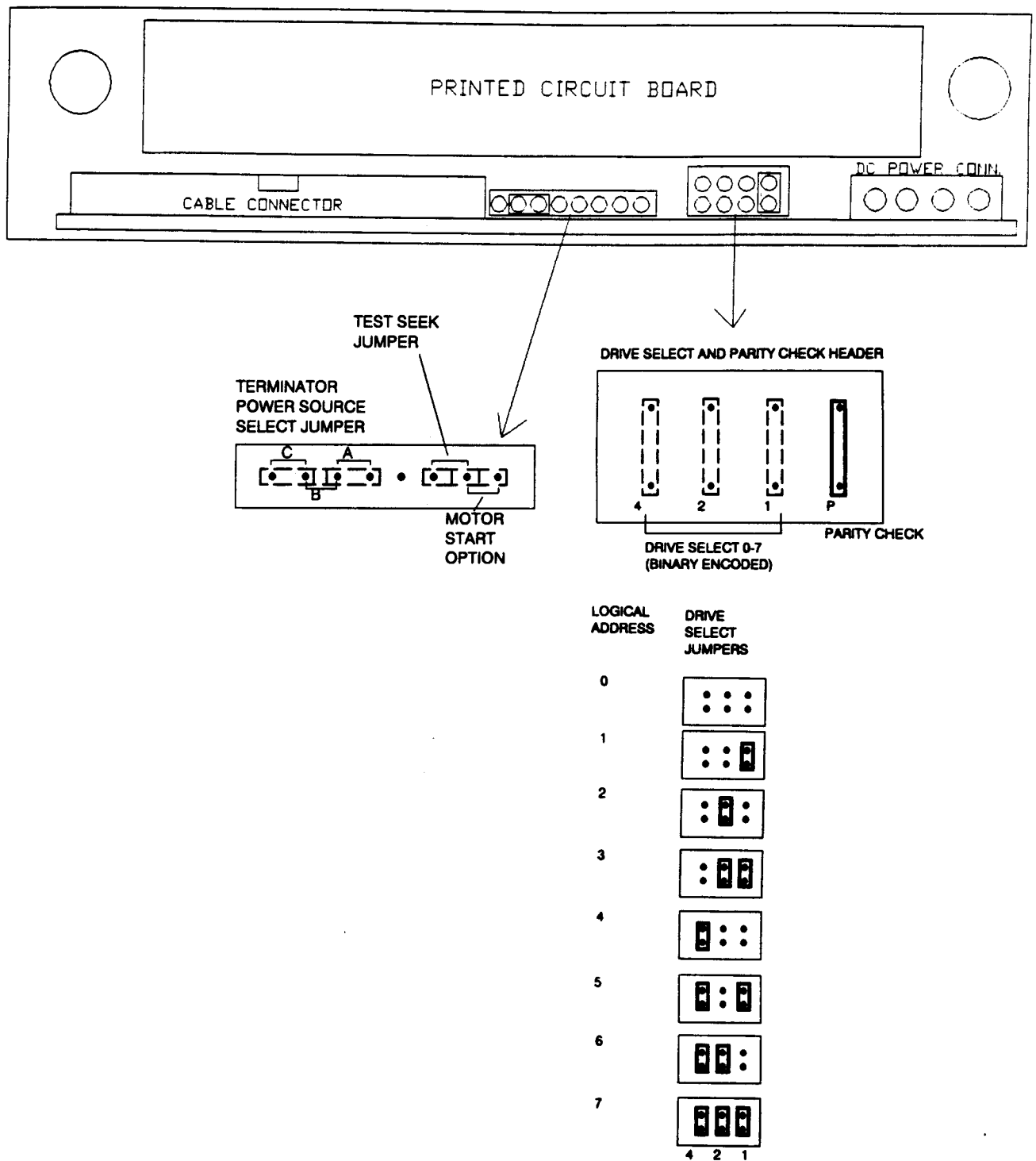
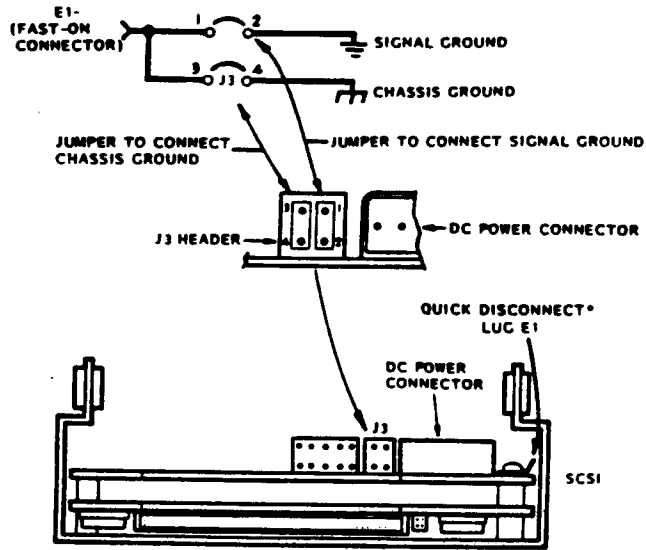
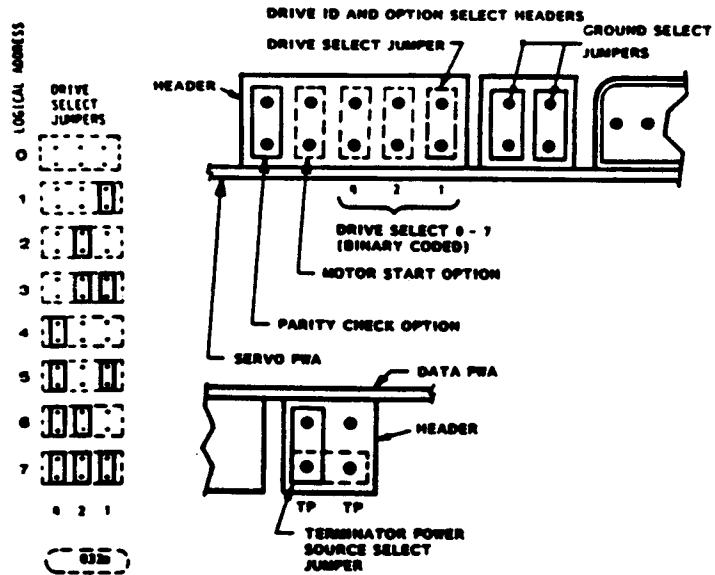

Figure 164. 170 MEG Quantum 5 1/4" SCSI Hard Drive



MM663d

344 MB FULL HEIGHT RIGID DISK DRIVE



025

344 MB FULL HEIGHT SCSI DRIVE ID AND OPTION SELECT HEADER

Figure 165. 344 MEG Quantum 5 1/4" SCSI Hard Drive

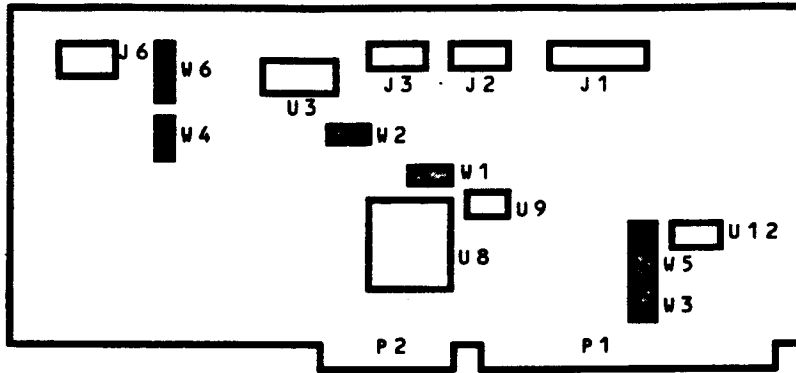

Figure 166. ST506 WD1003-WAH Hard Drive Controller

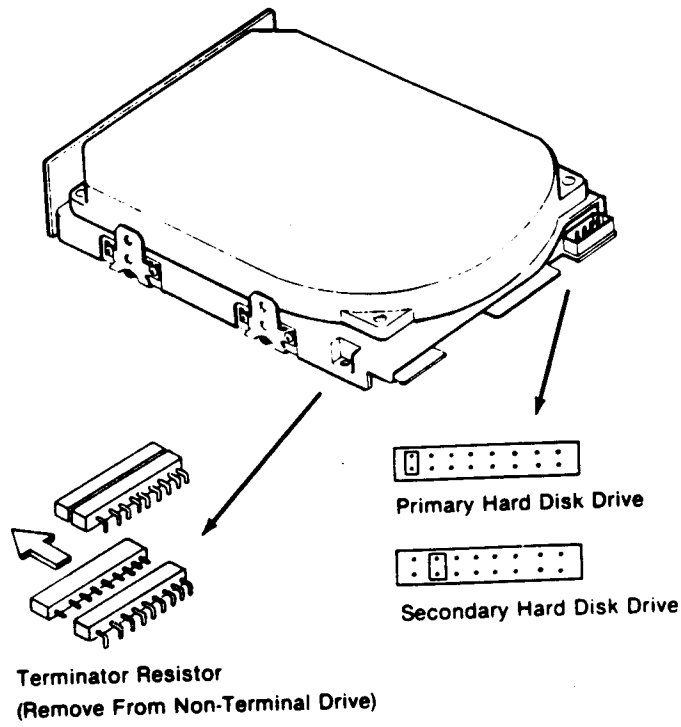

Figure 167. 40 MEG Seagate ST251 5 1/4" ST506 Hard Drive

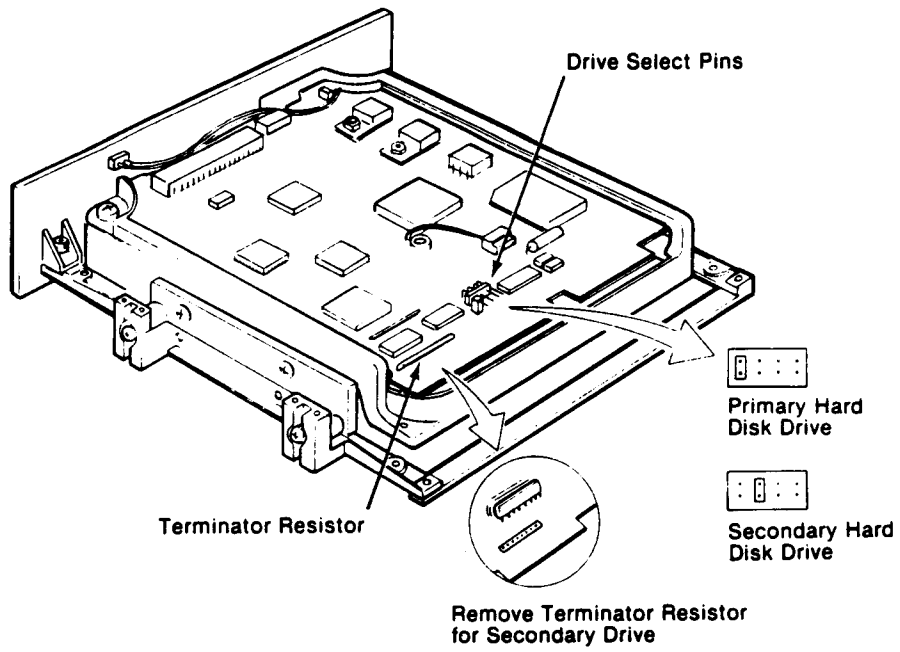

Figure 168. 40 MEG Rodime 3055 3 1/2" ST506 Hard Drive

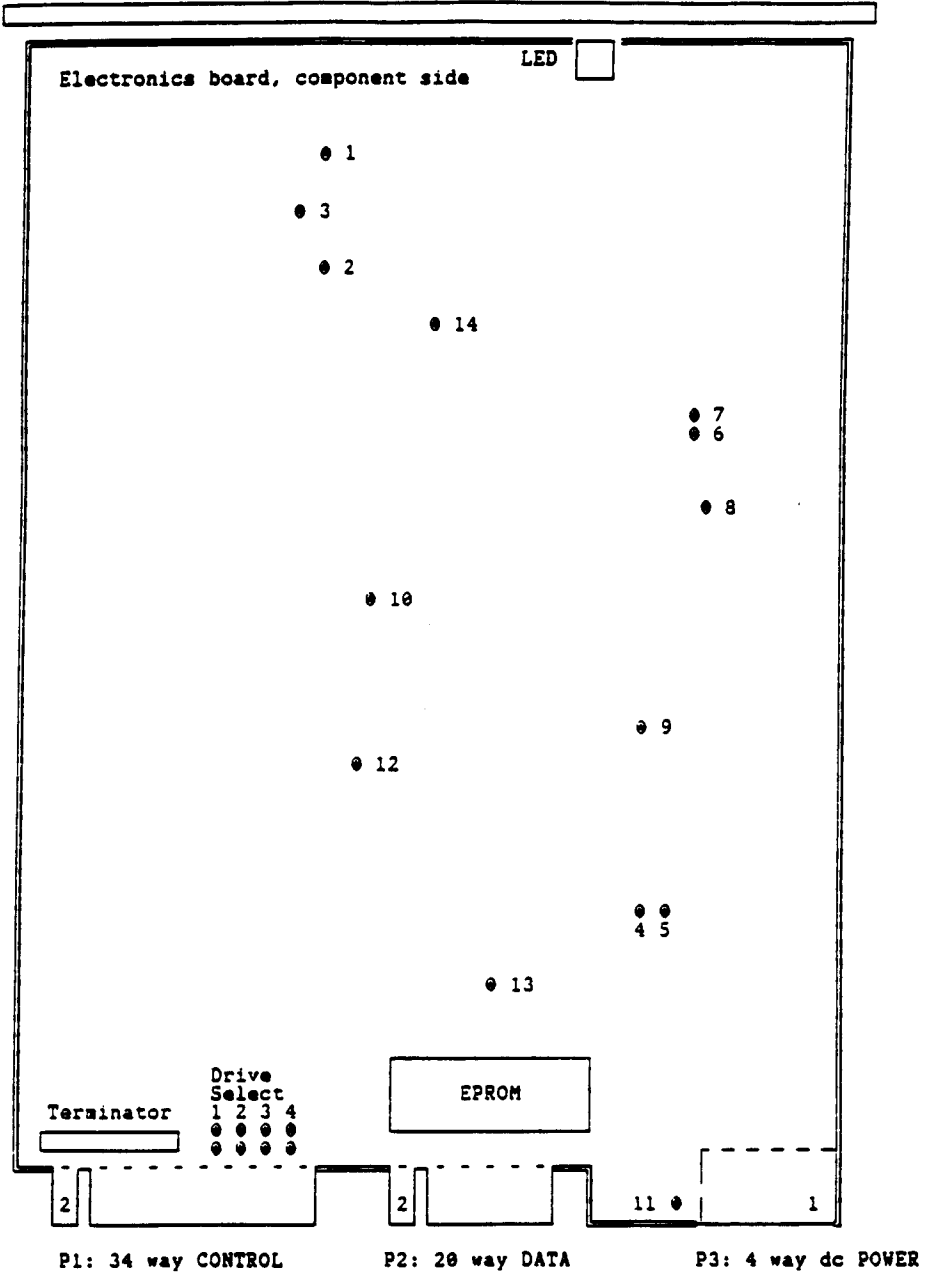

Figure 169. 70 MEG Rodime 5090 5 1/4" ST506 Hard Drive

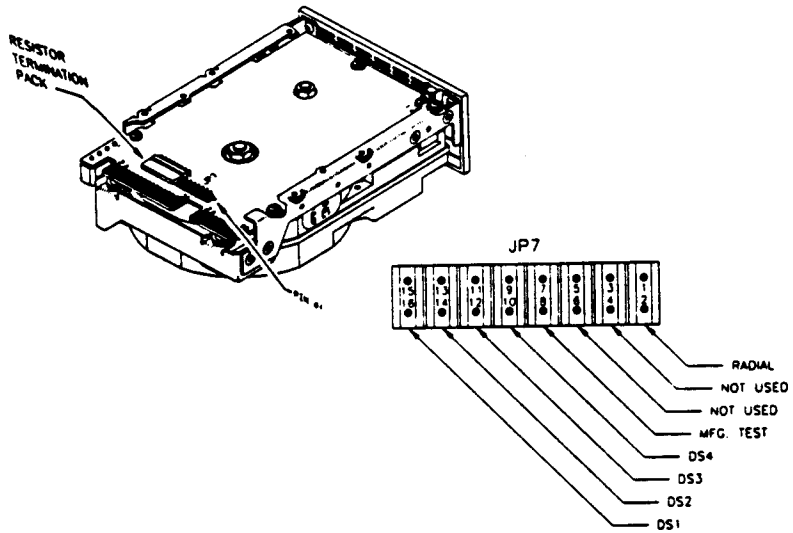

Figure 170. 40 MEG Seagate ST151 3 1/2" ST506 Hard Drive for 5000MC

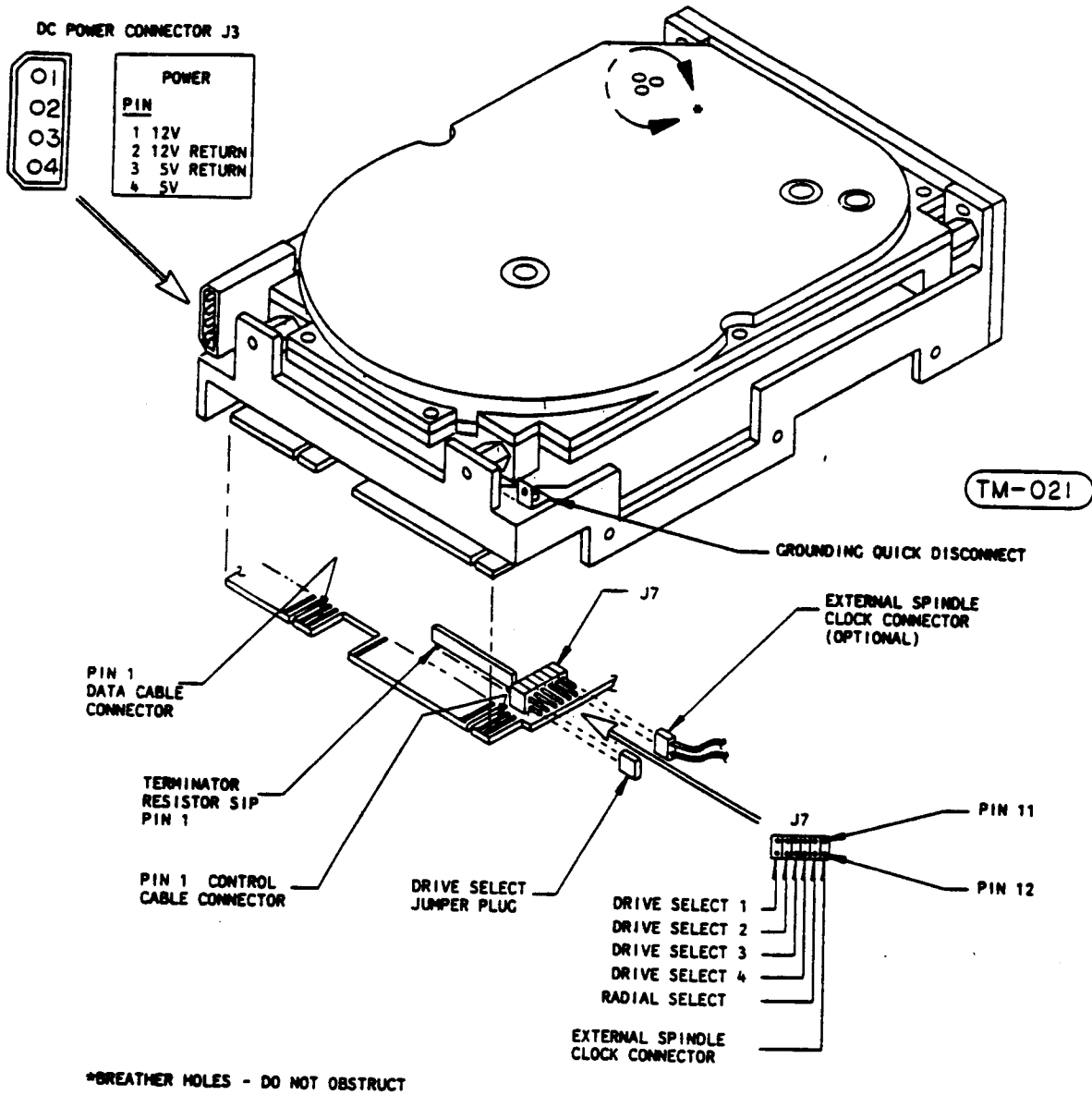

Figure 171. 80 MEG CDC 94355 3 1/2" ST506 Hard Drive for 5000MC

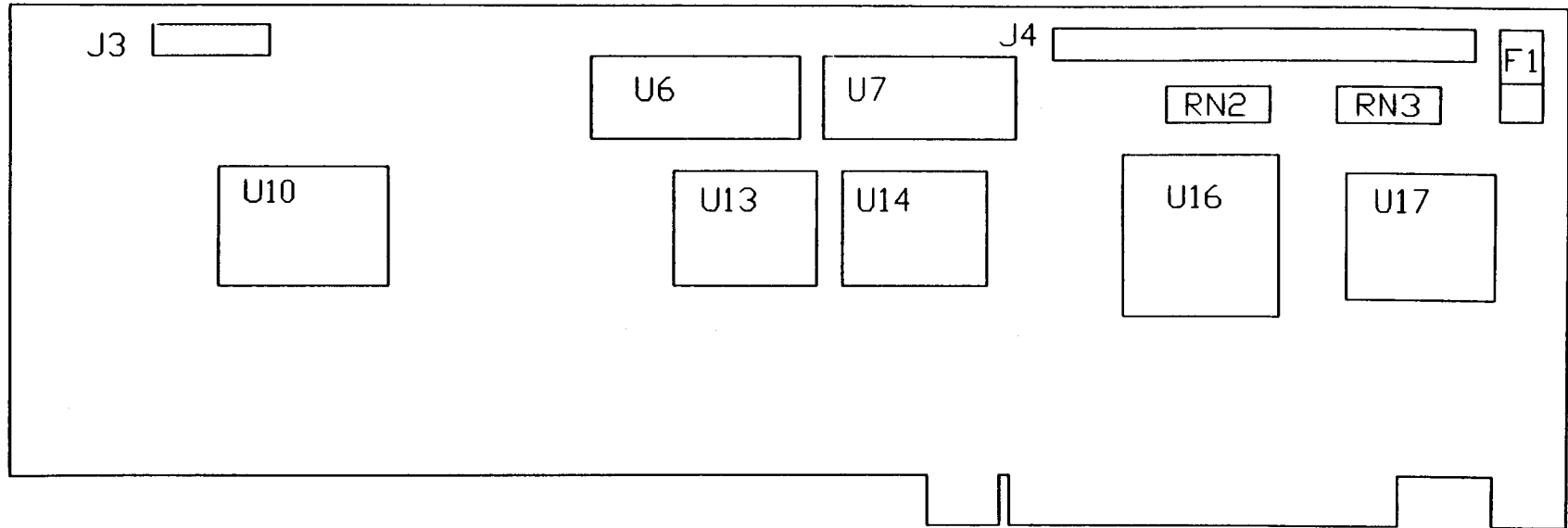

Figure 172. 16 Bit SCSI HD Controller for Tandy 5000MC

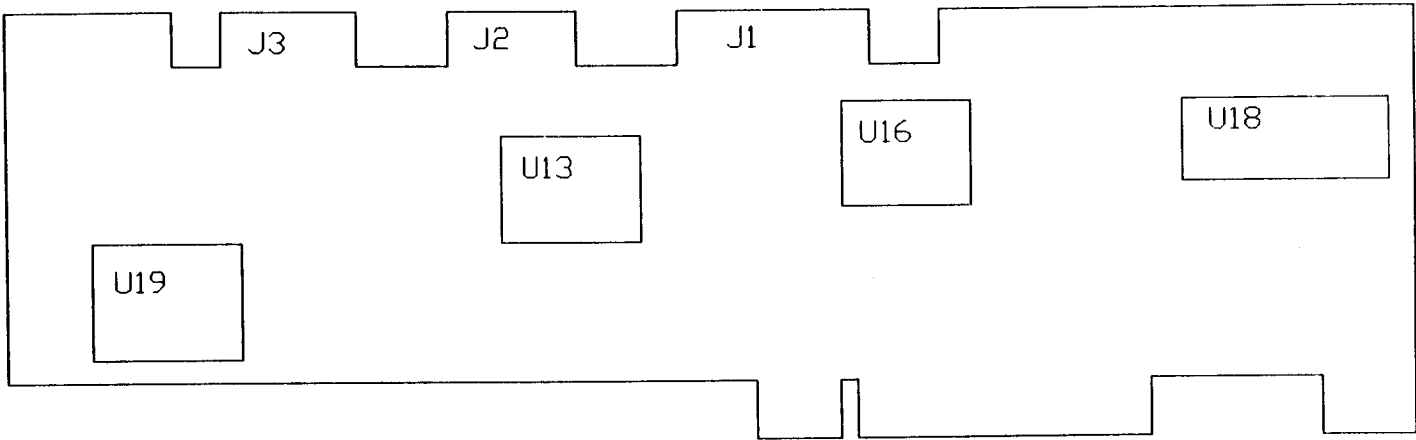

Figure 173. ST506-MC 5000 HD Controller

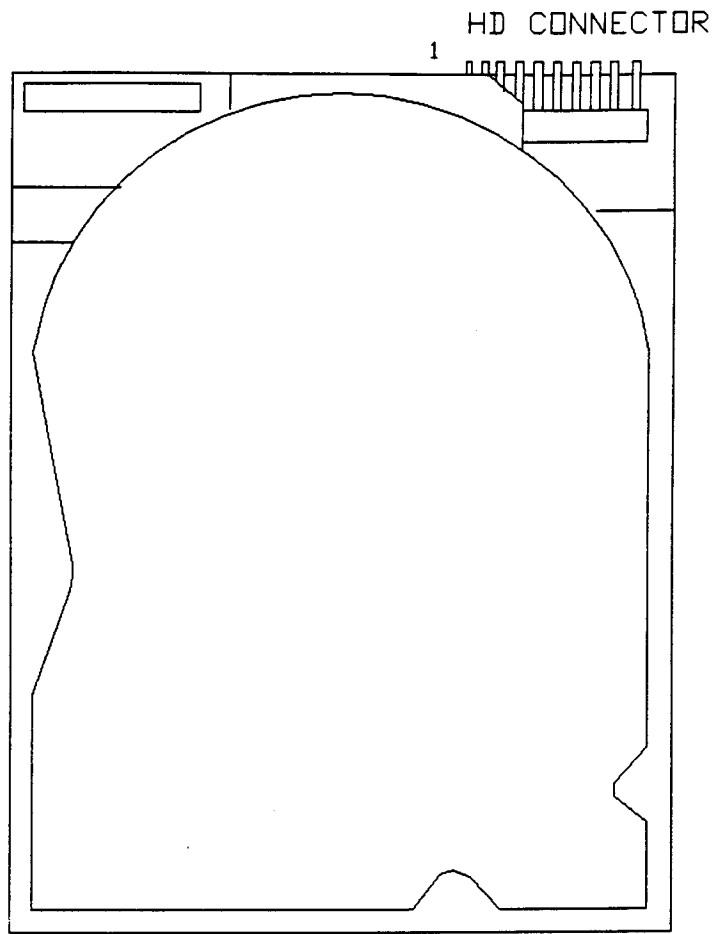

Figure 174. 20 MEG CMS (1400 LT) 3 1/2" Hard Drive

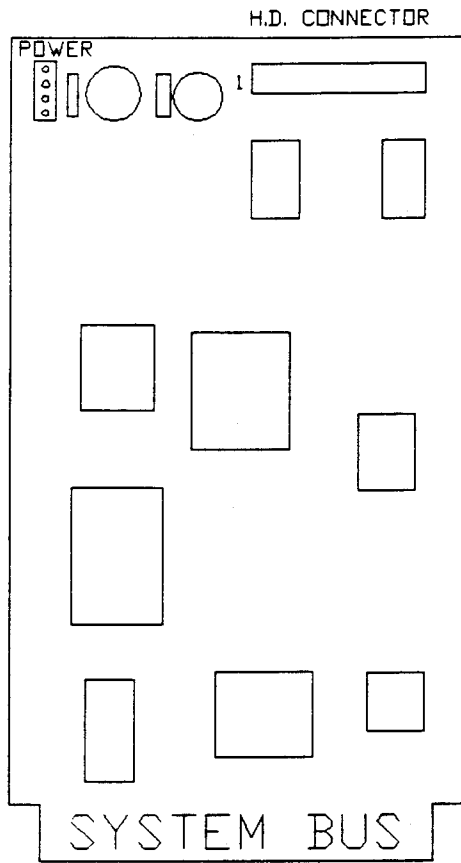
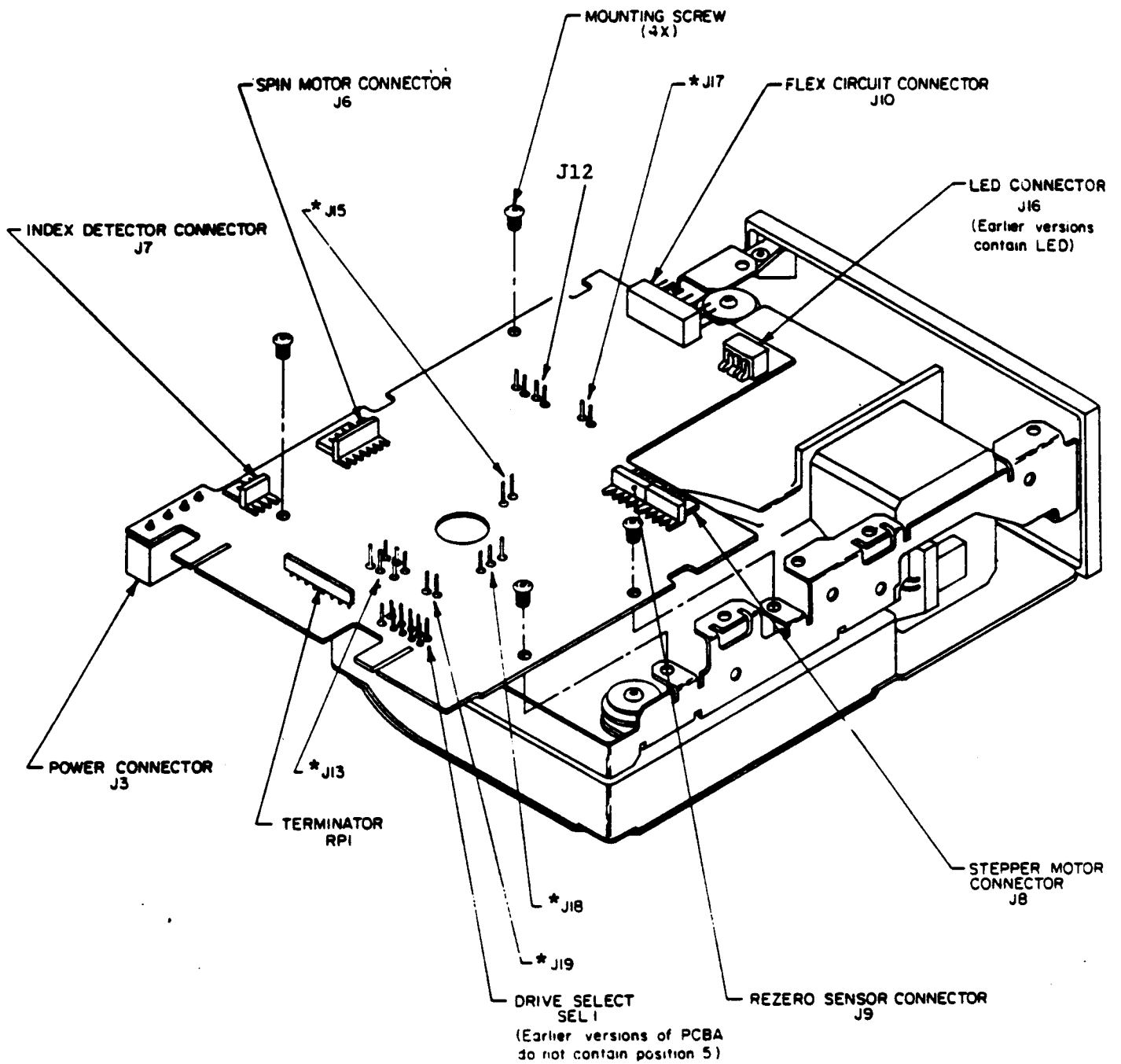

Figure 175. Lite Drive Controller Board



* Earlier versions of PCBA do not contain these jumpers.

Figure 176. 20 MEG MiniScribe 8438 Hard Card
Version 1

**TABLE 3-3
SHUNT PLUG PROGRAMMING GUIDE**

Shunt	Signal
W4	Drive Select 3
W3	Drive Select 2
W2	Drive Select 1
W1	Drive Select 0
W5	Radial Configuration

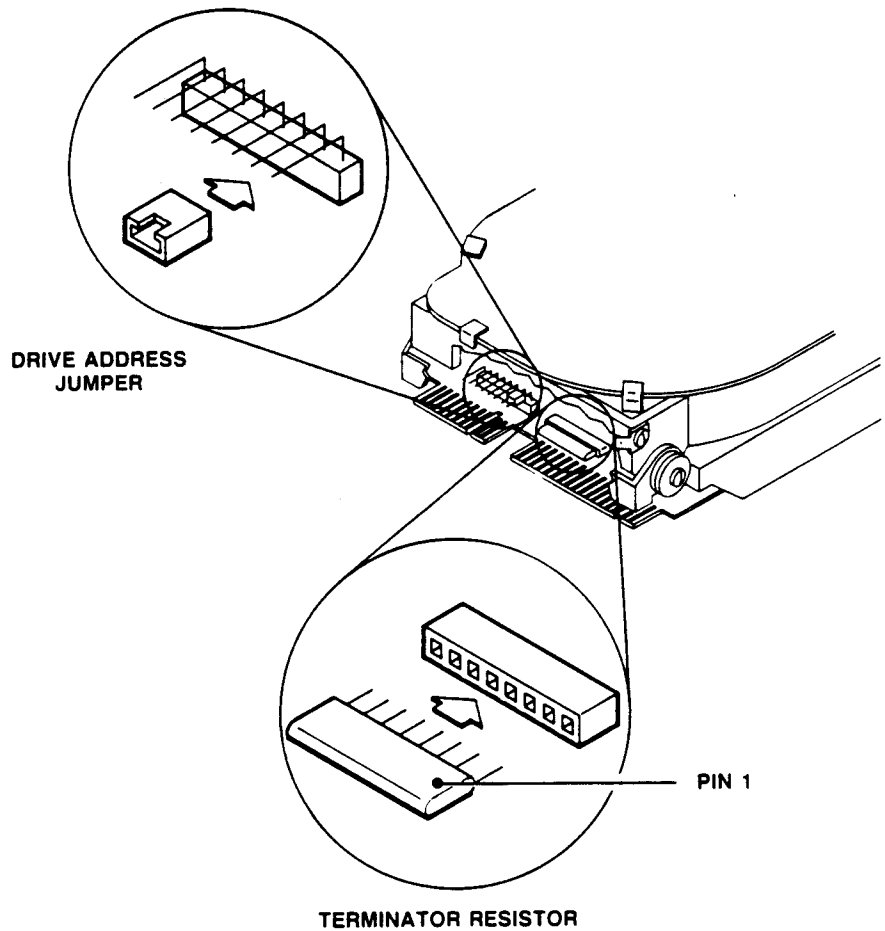
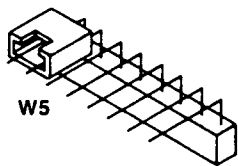
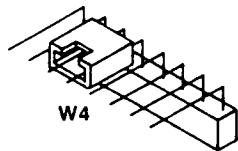
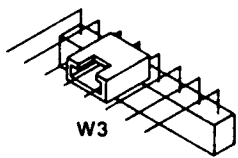
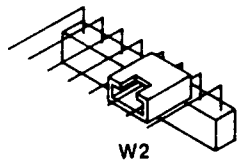
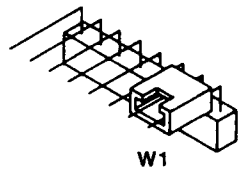

Figure 177. 20 MEG Tandon TM362 Hard Card
20 MEG Western Digital WD362 Hard Card

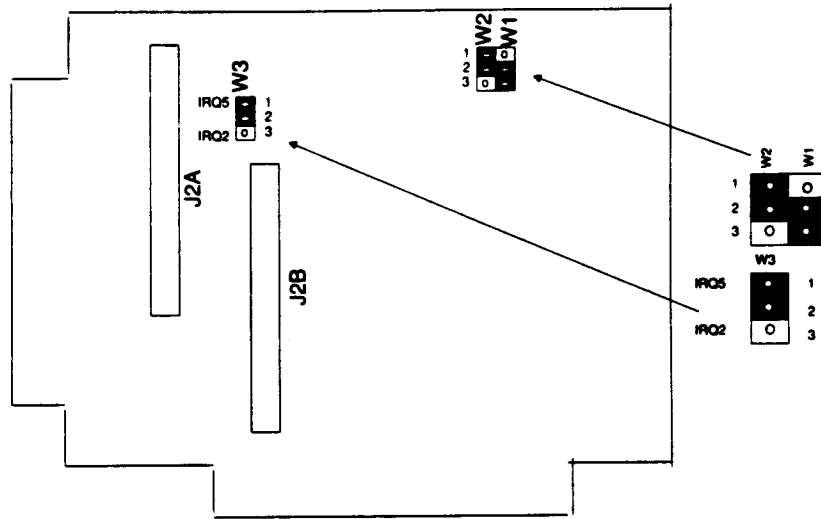

Figure 178. 20 MEG Western Digital 93028 IDE Hard Card Controller Board
 40 MEG Western Digital 93044 IDE Hard Card Controller Board

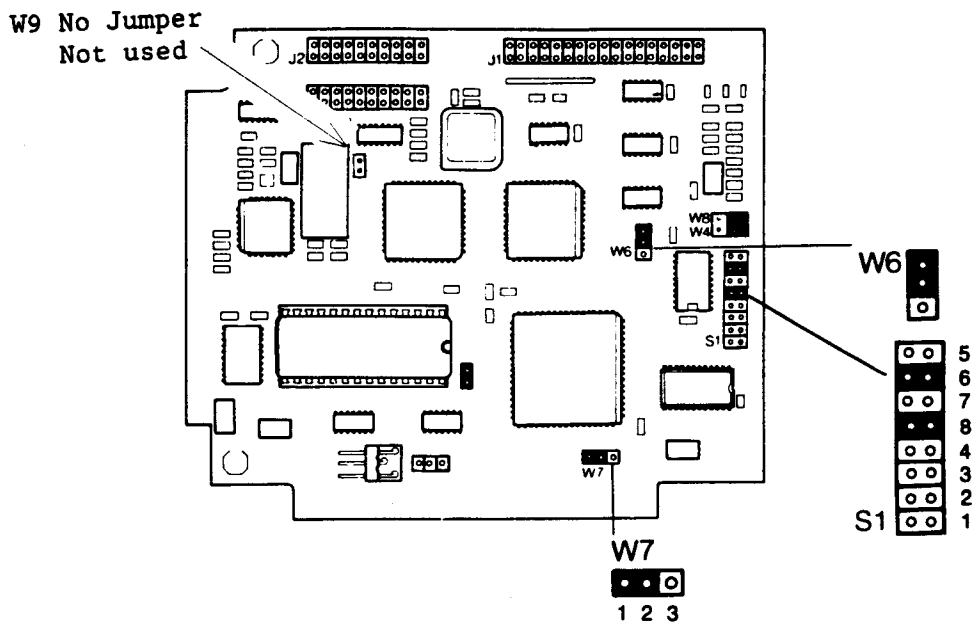

Figure 179. 40 MEG Seagate 157 Hard Card Controller Board

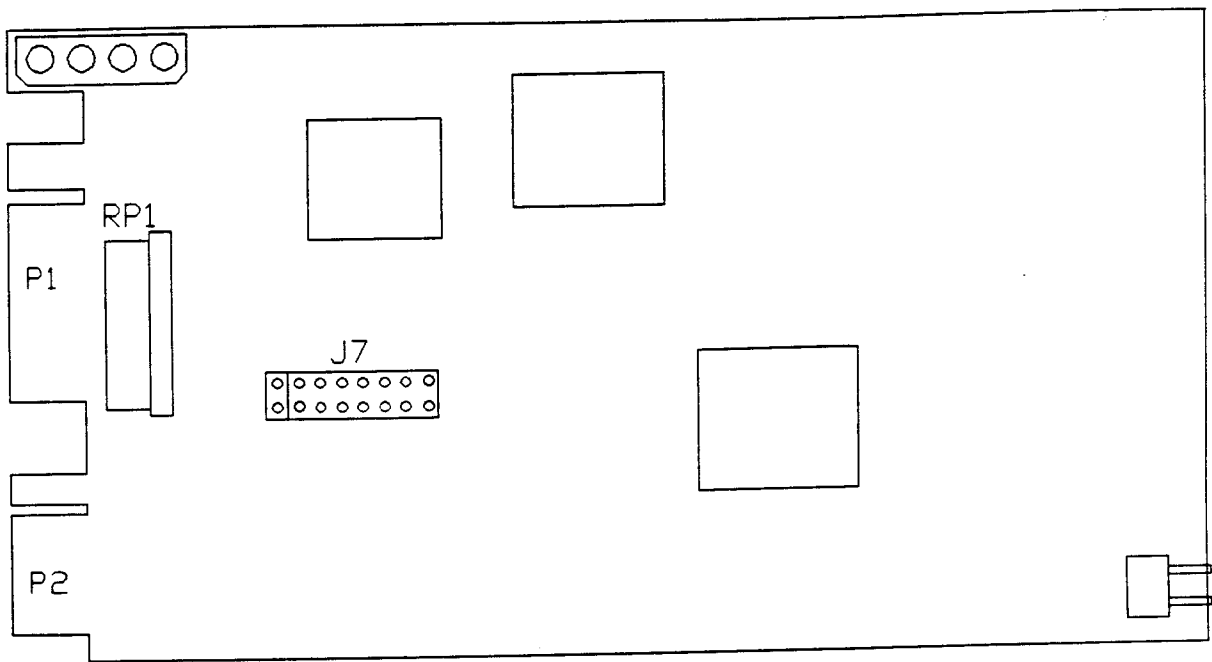

Figure 180. 40 MEG Seagate 157 Hard Card

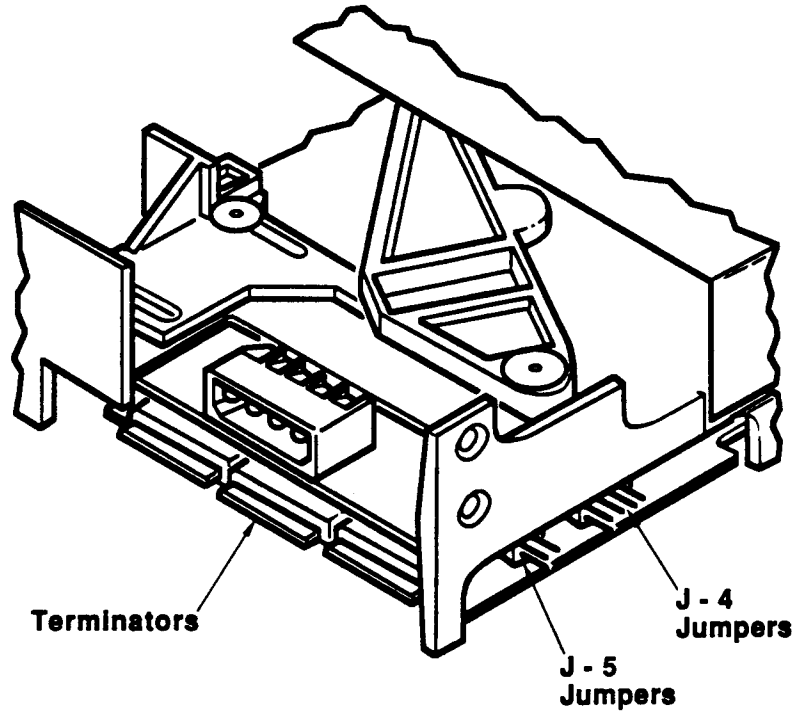

Figure 181. 150 MEG 5 1/4" SCSI Tape Drive

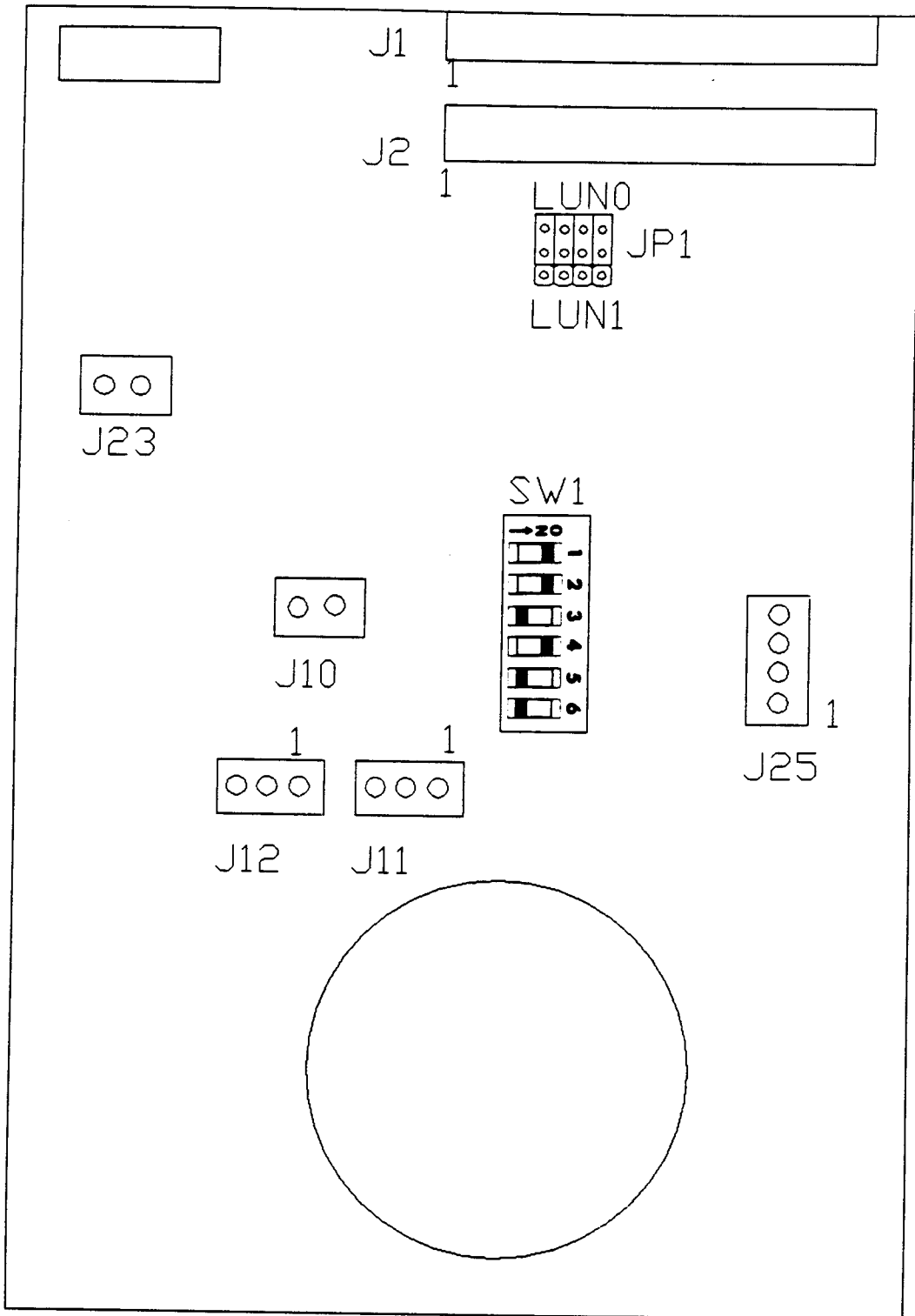

Figure 182. 20 MEG Internal Disk Cartridge System "A" Version

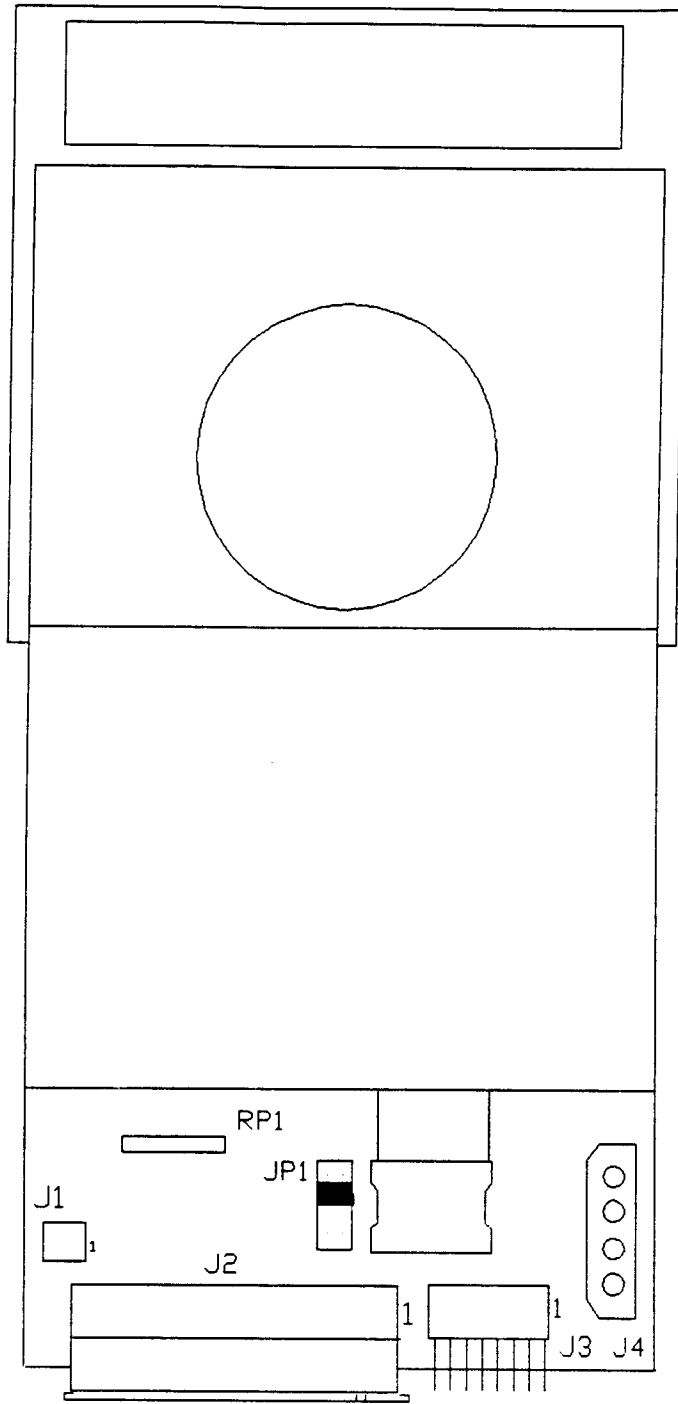
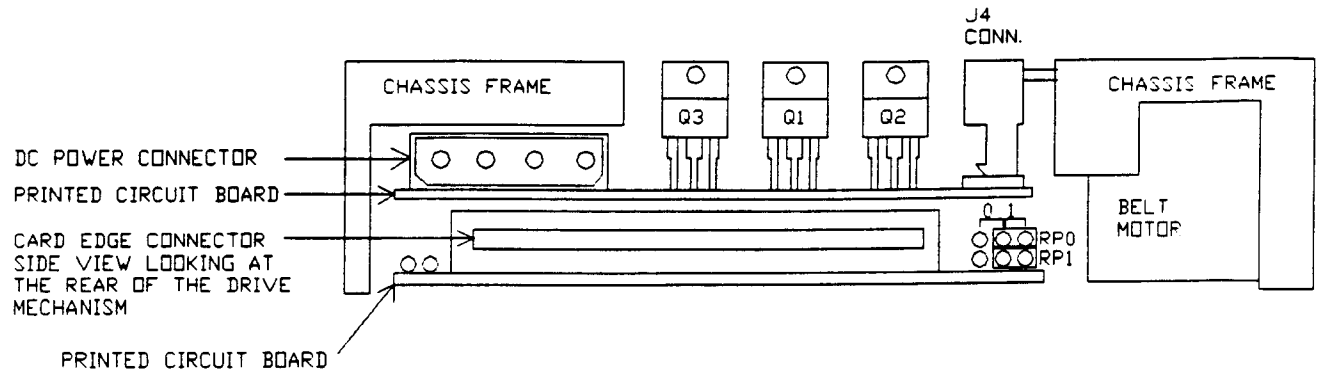

Figure 183. 40 MEG Internal Tape Cartridge System
 40 MEG Internal Tape Cartridge System "A" Version



Archive Tape Drive Mechanism - Rear view

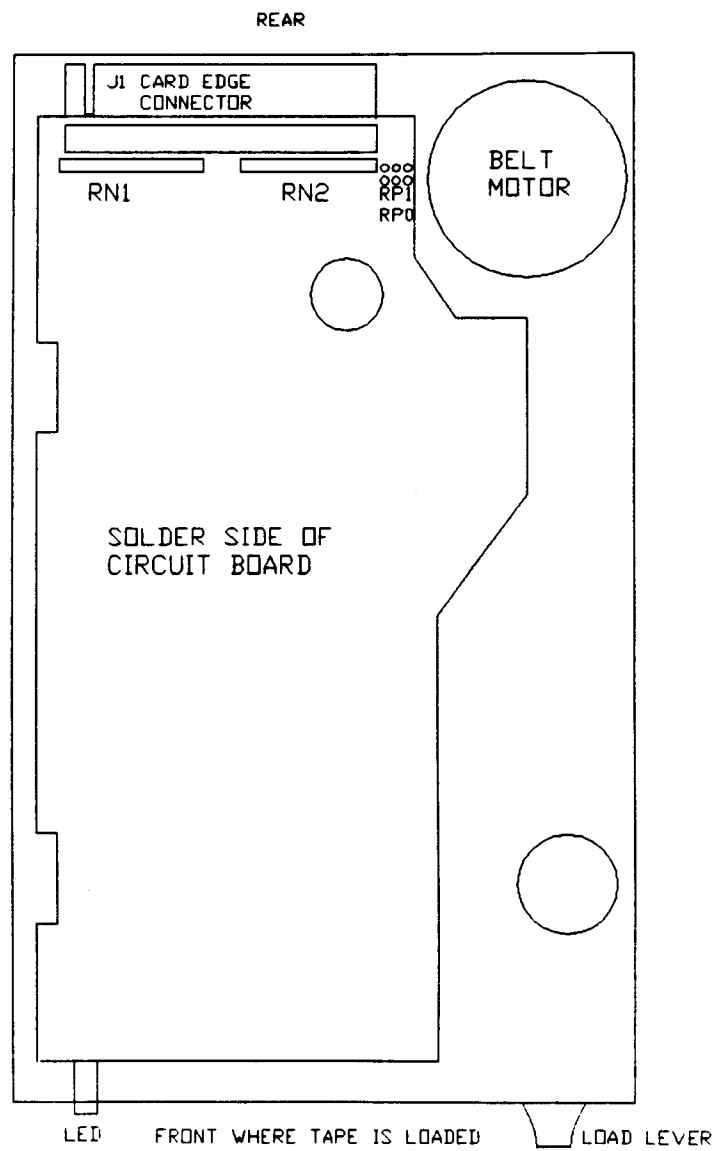

Figure 184. Archive Tape Drive Mechanism - Bottom view

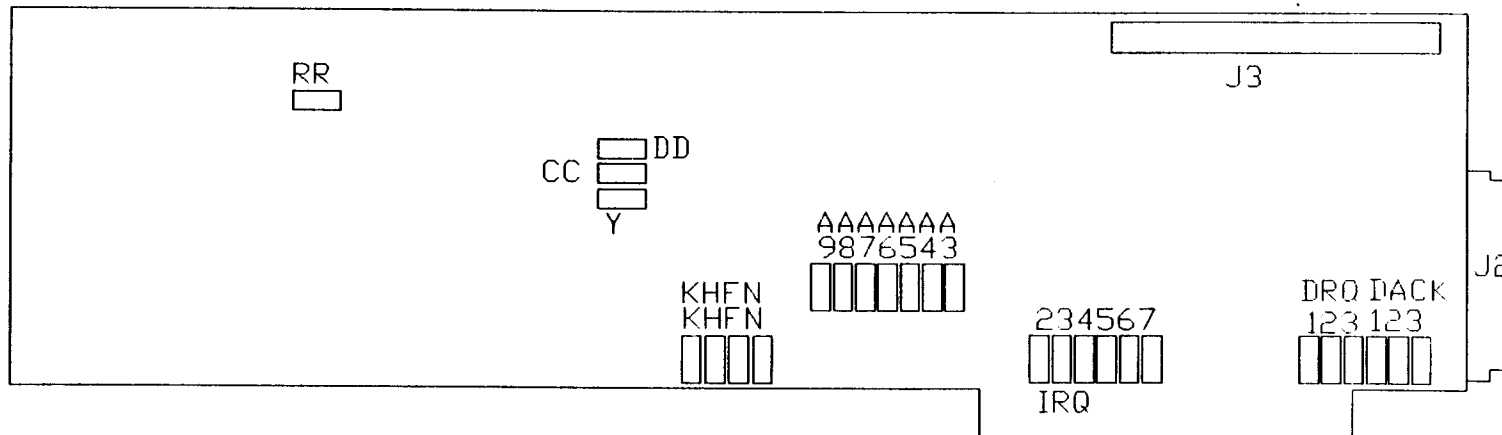

Figure 185. Long Interface Board SC-499

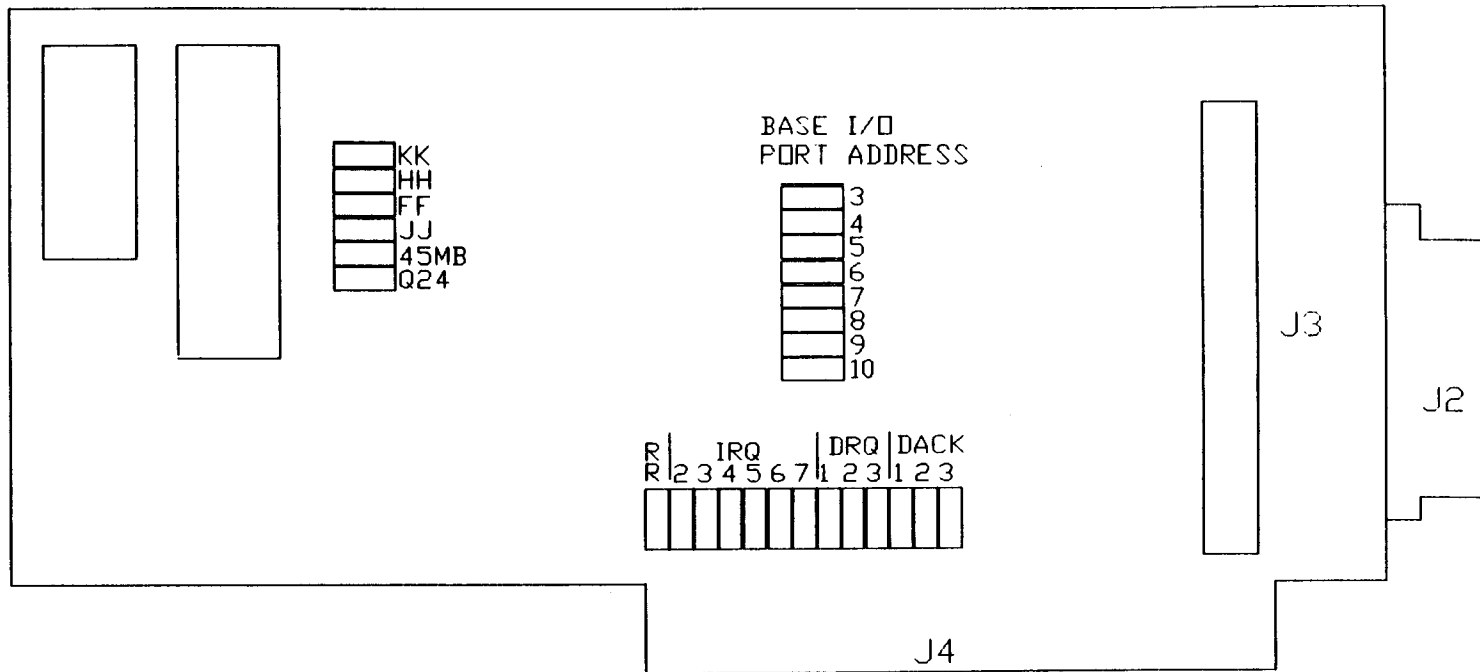

Figure 186. Short Interface Board SC-499R

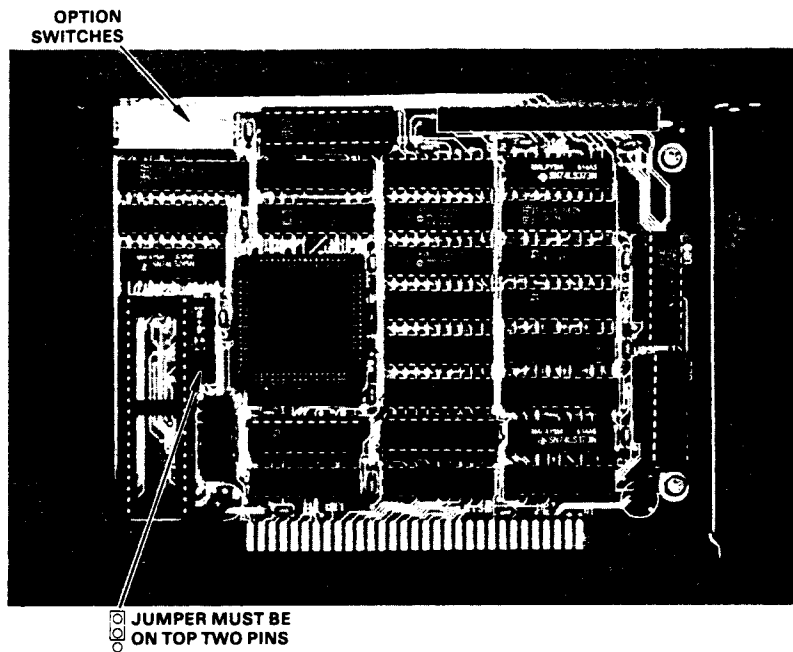

Figure 187. 286 Express Board For Tandy 1000/A/SX series computers.

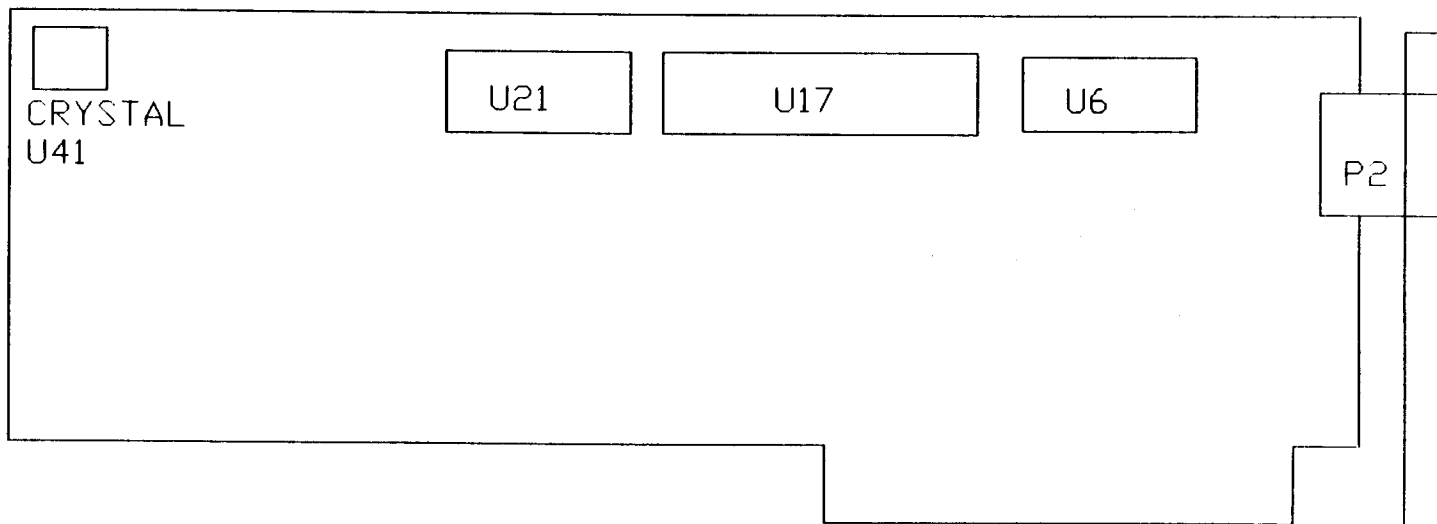

Figure 188. Deluxe Text Display Adapter Revision B AX-Ø189 Short version
Deluxe Text Display Adapter Revision C AX-Ø233 Short version

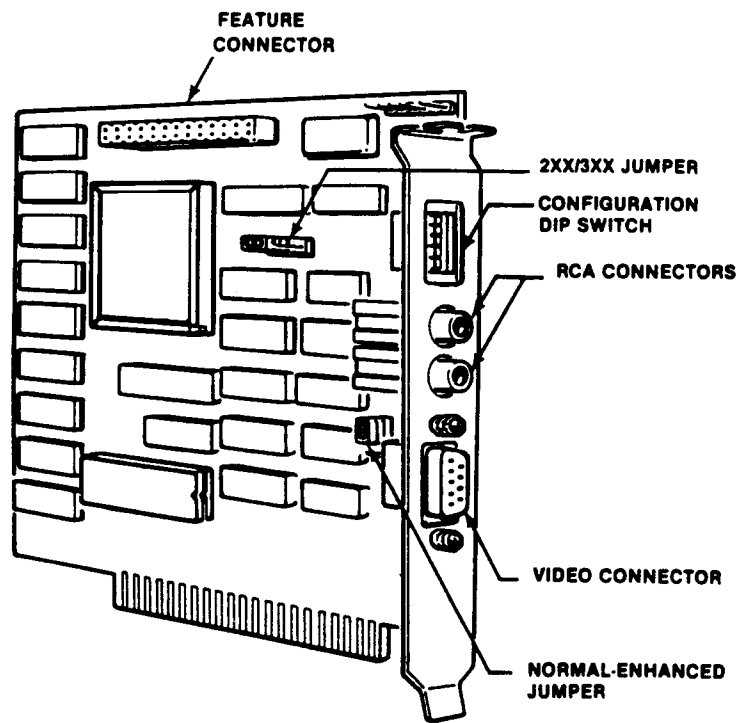

Figure 189. EGA/CGA Video Board

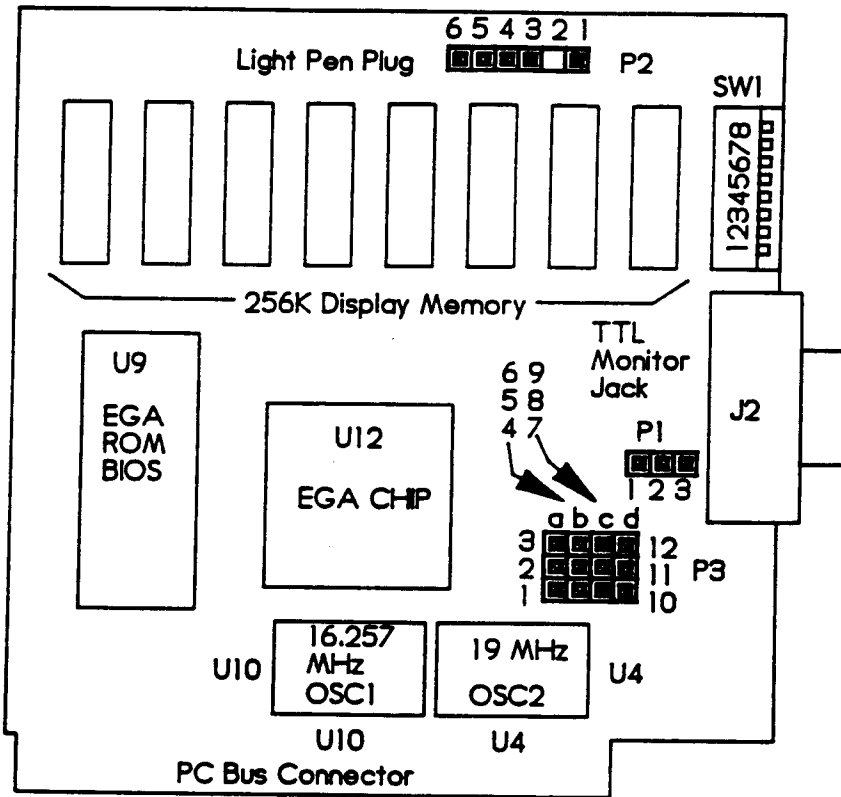

Figure 190. EGA/CGA Video Board "A" Version

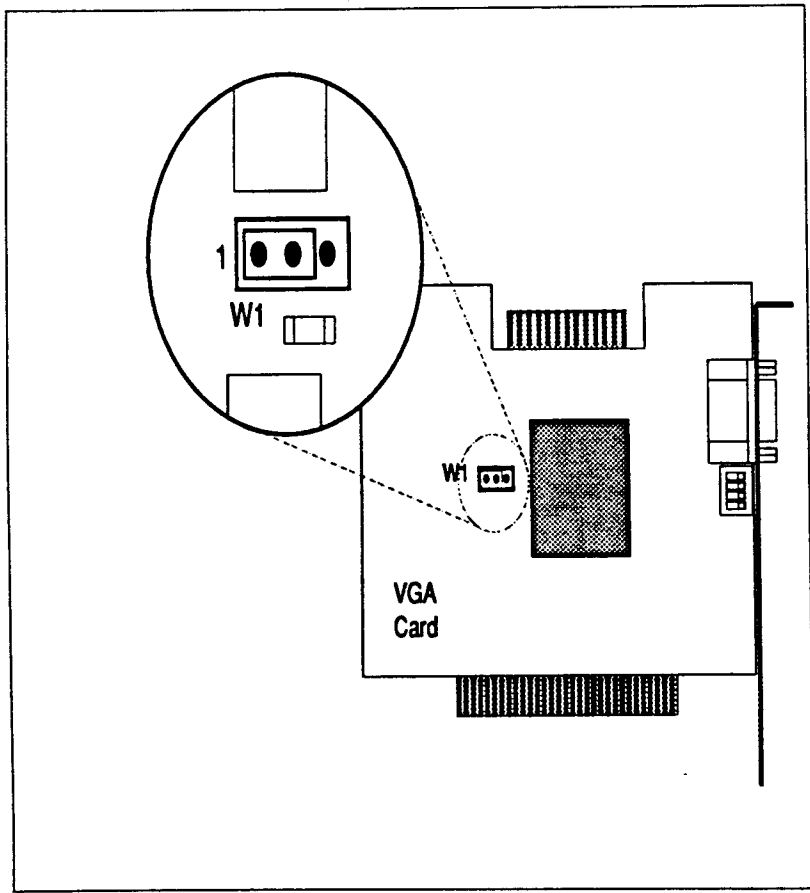
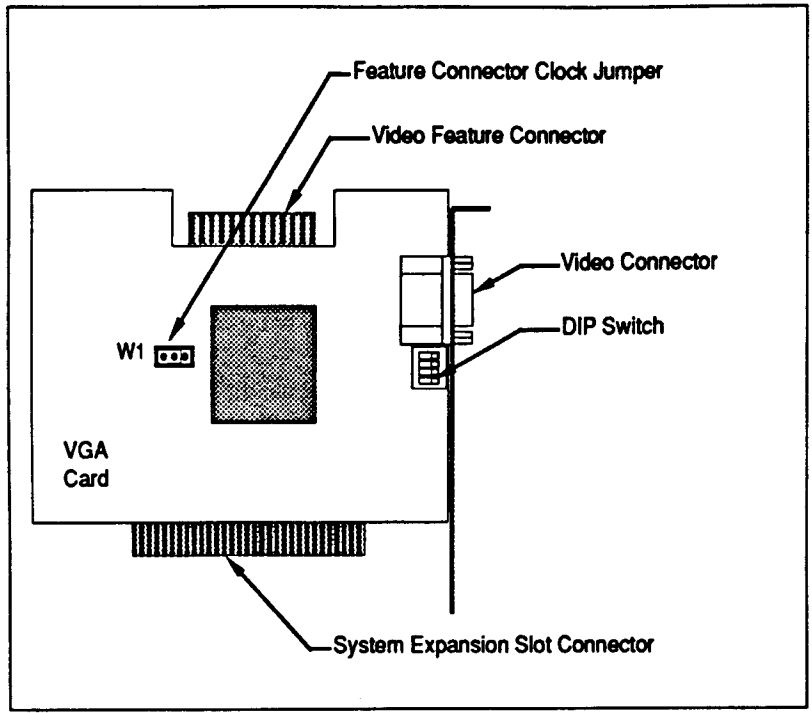

Figure 191. VGA Graphics Adapter Board

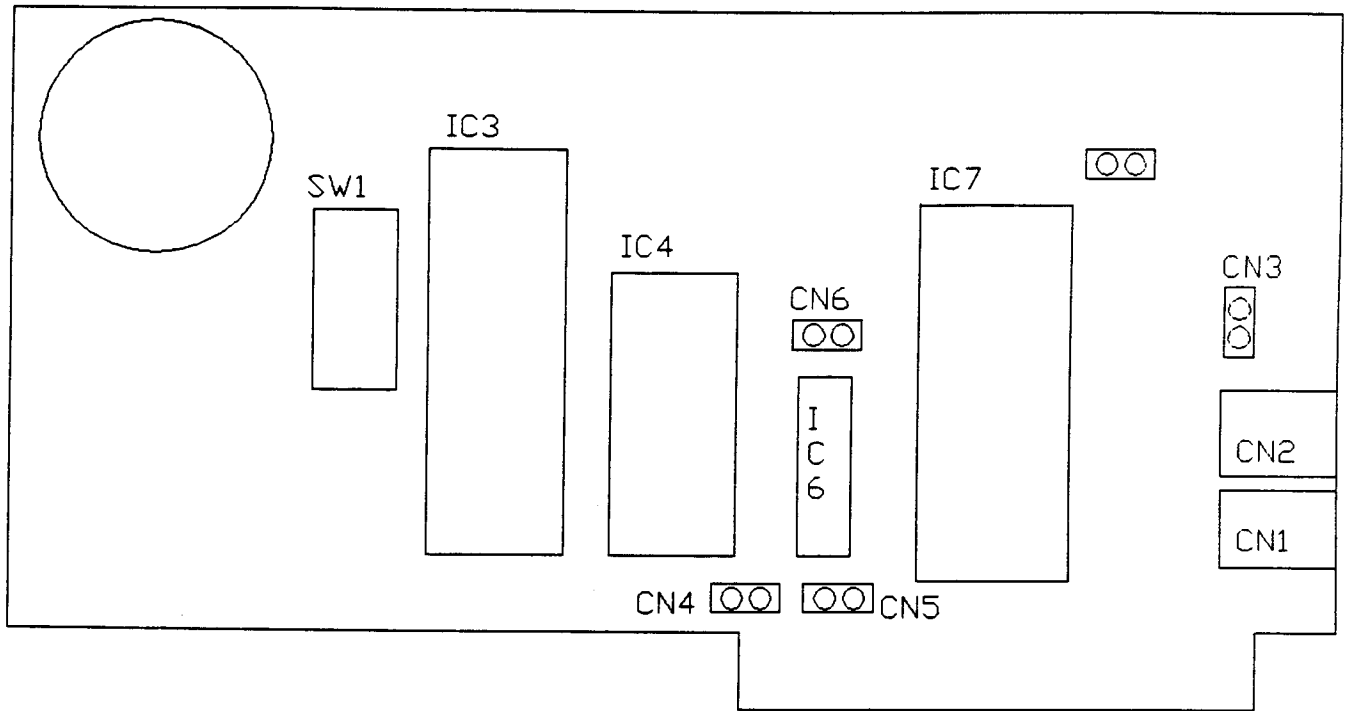

Figure 192. 1200 Baud Internal Modem Board Revision D and E

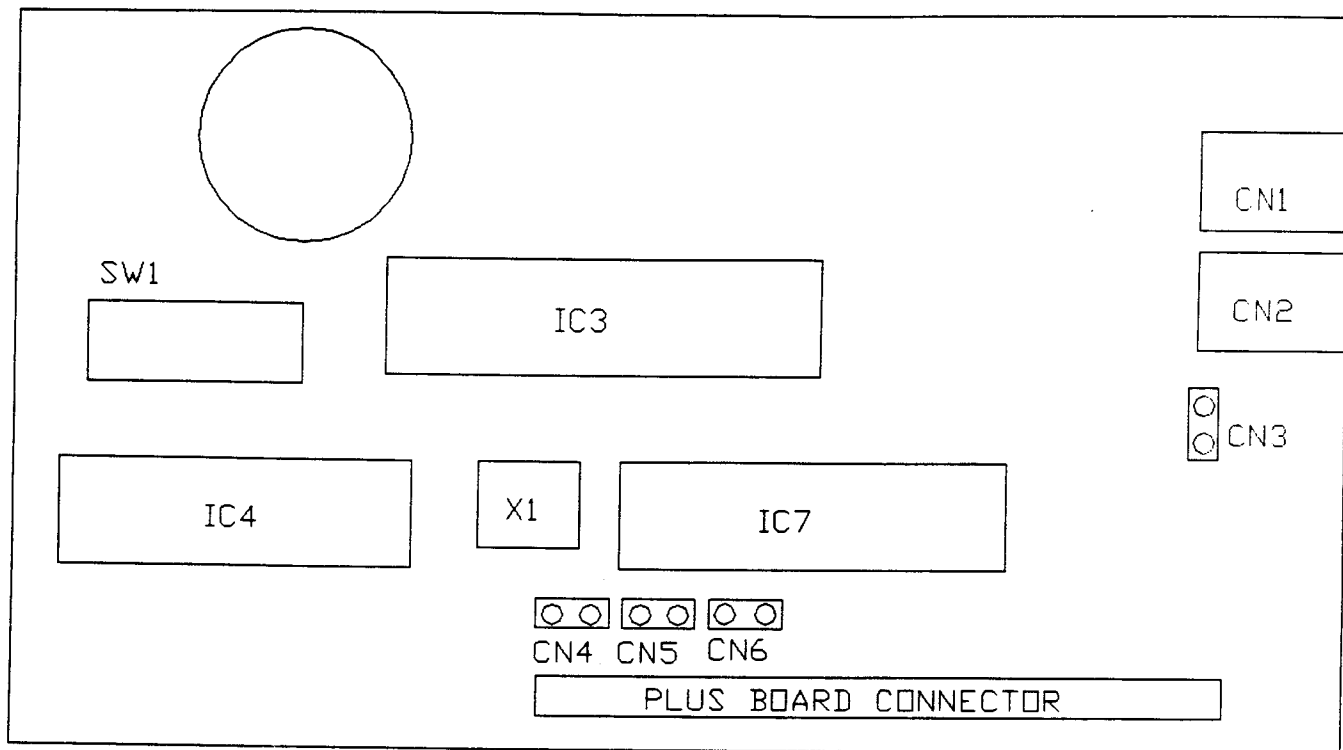

Figure 193. 1200 Baud PLUS Modem Board Revision A

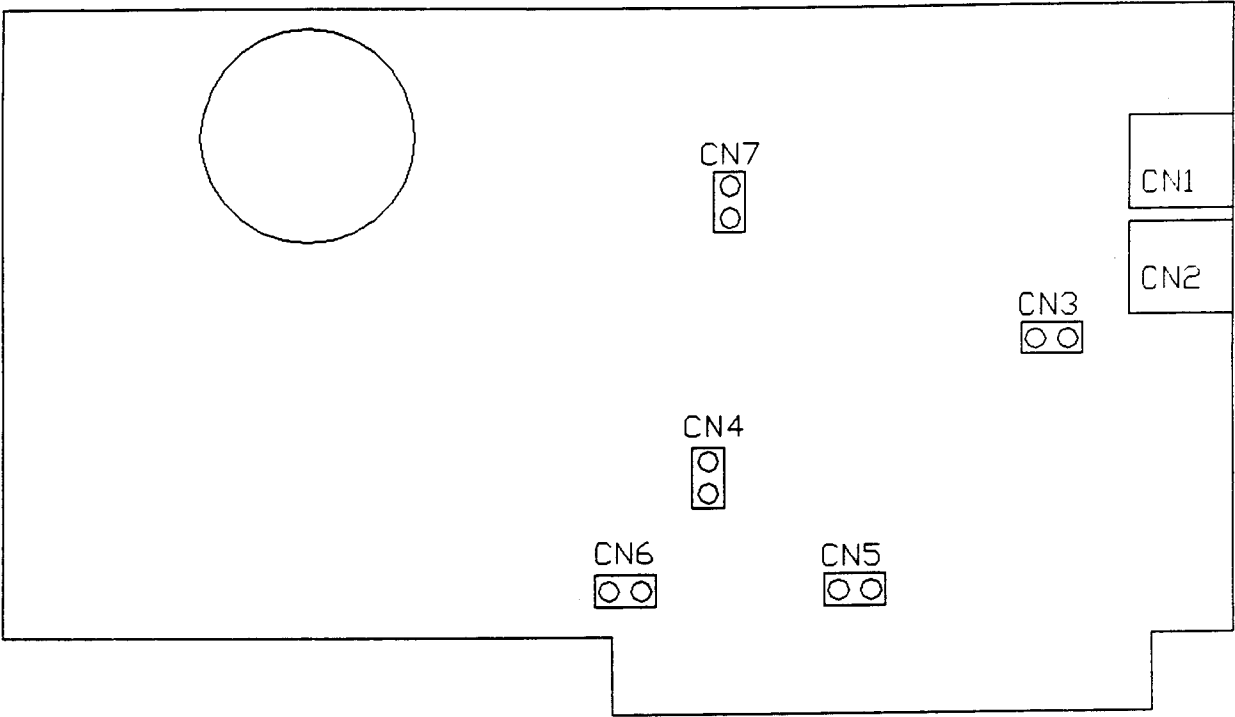

Figure 194. 2400 Baud Internal Modem Board Revision Plain/A

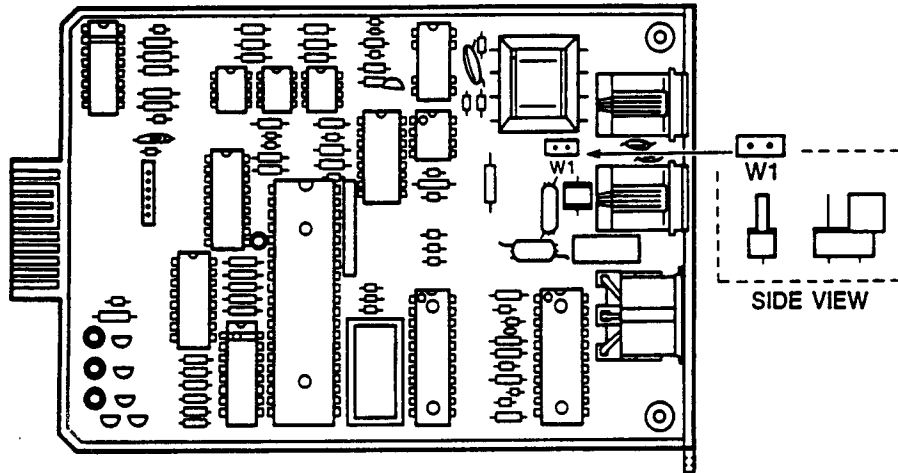
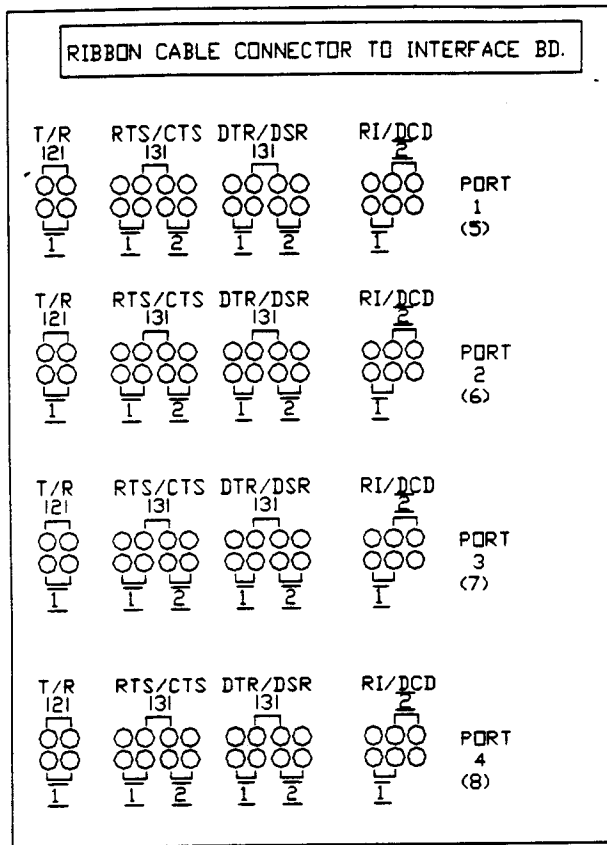

Figure 195. 1200 Baud LT1400 Internal Modem Board



Ribbon Cable Connector Board

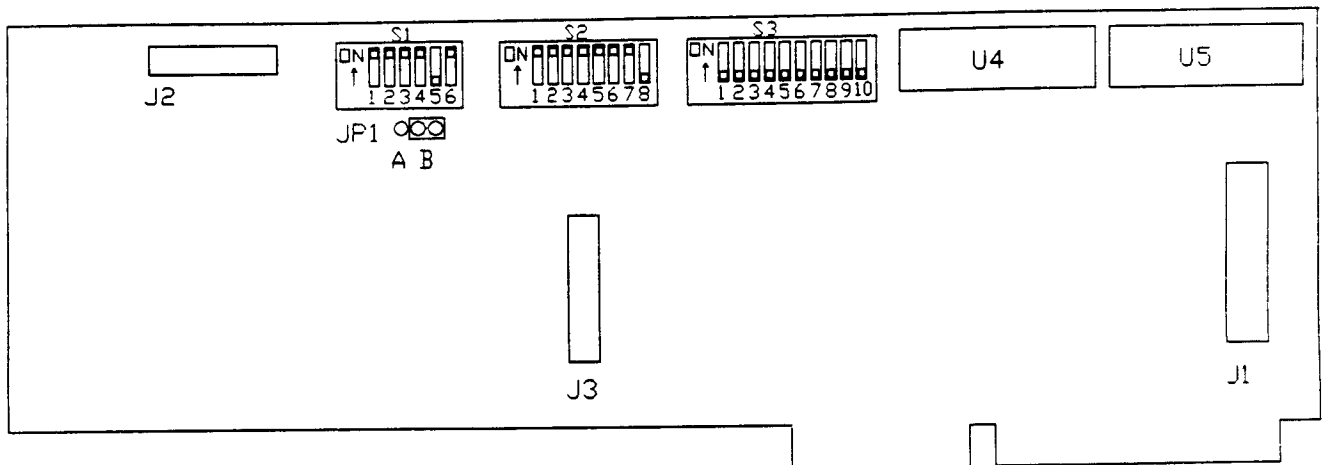

Figure 196. ARNET Smartport 4 Board

P3 PLUGS ONTO SMARTPORT 4
INTERFACE BOARD CONNECTOR J3

J1 CONNECTOR FOR RIBBON
CABLE WHICH CONNECTS TO
D-SUB ADAPTER BOX

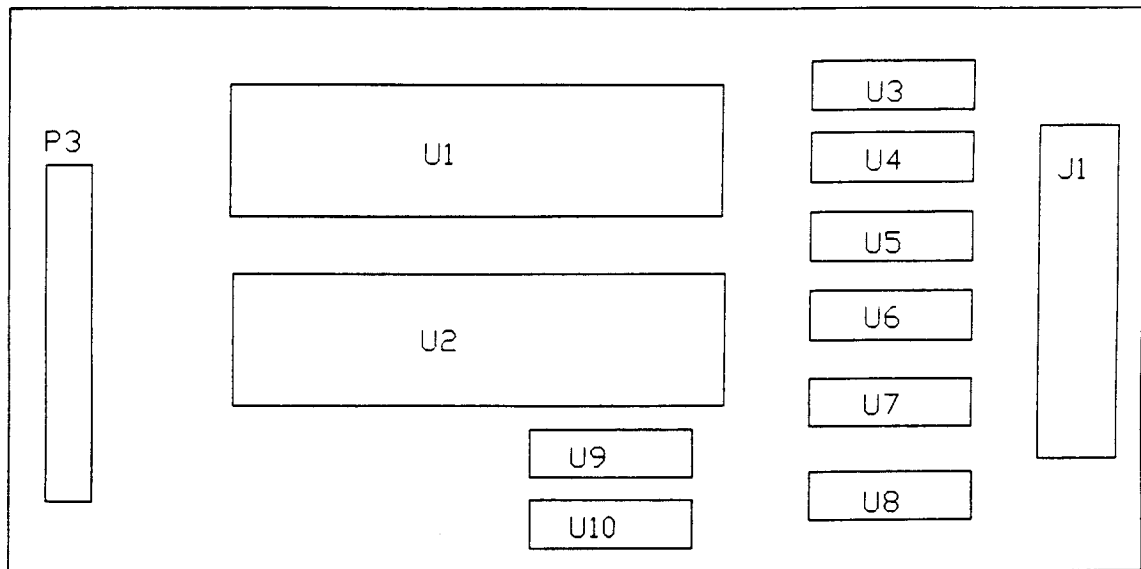

Figure 197. ARNET Smartport 8 Adapter Board

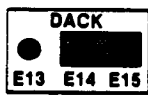
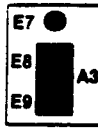
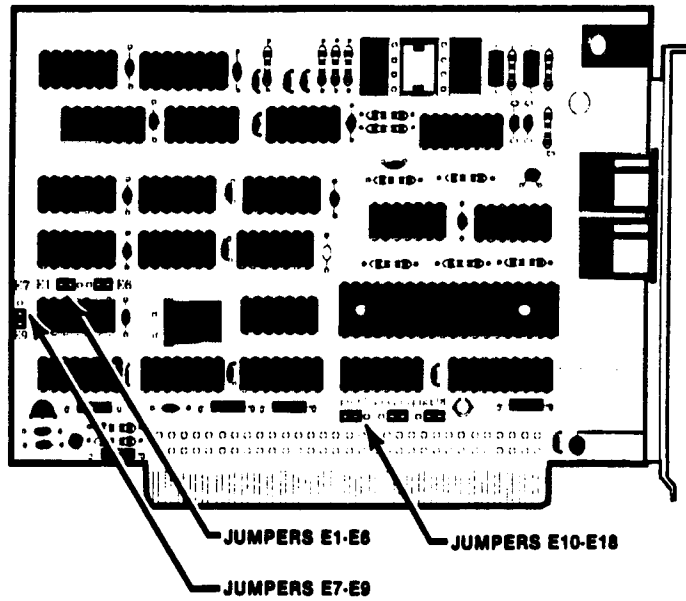

Figure 198. Tandylink Board
Tandylink PLUS Board

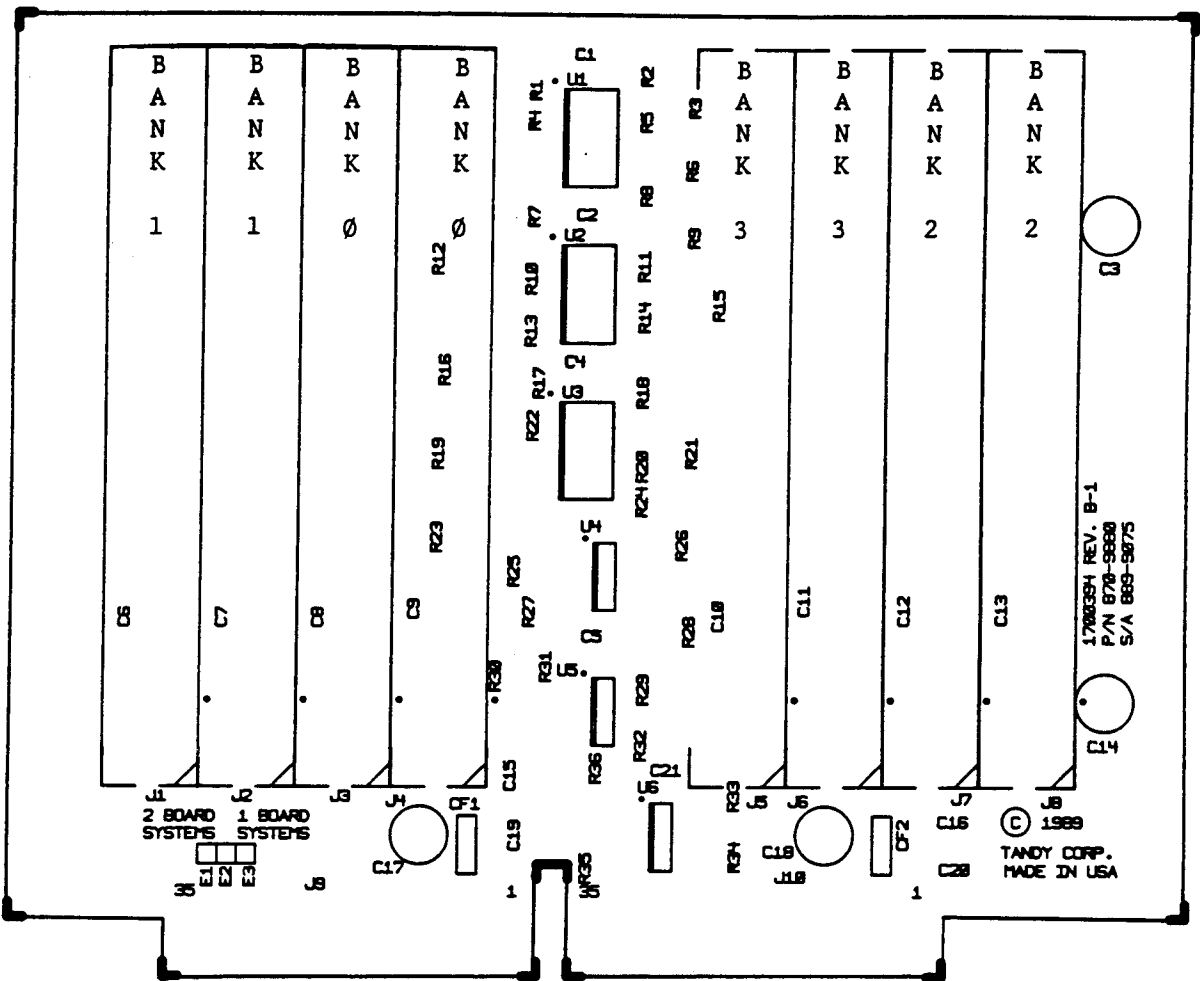

Figure 199. 0K Memory Expansion Adapter for Tandy 3000NL with jumper

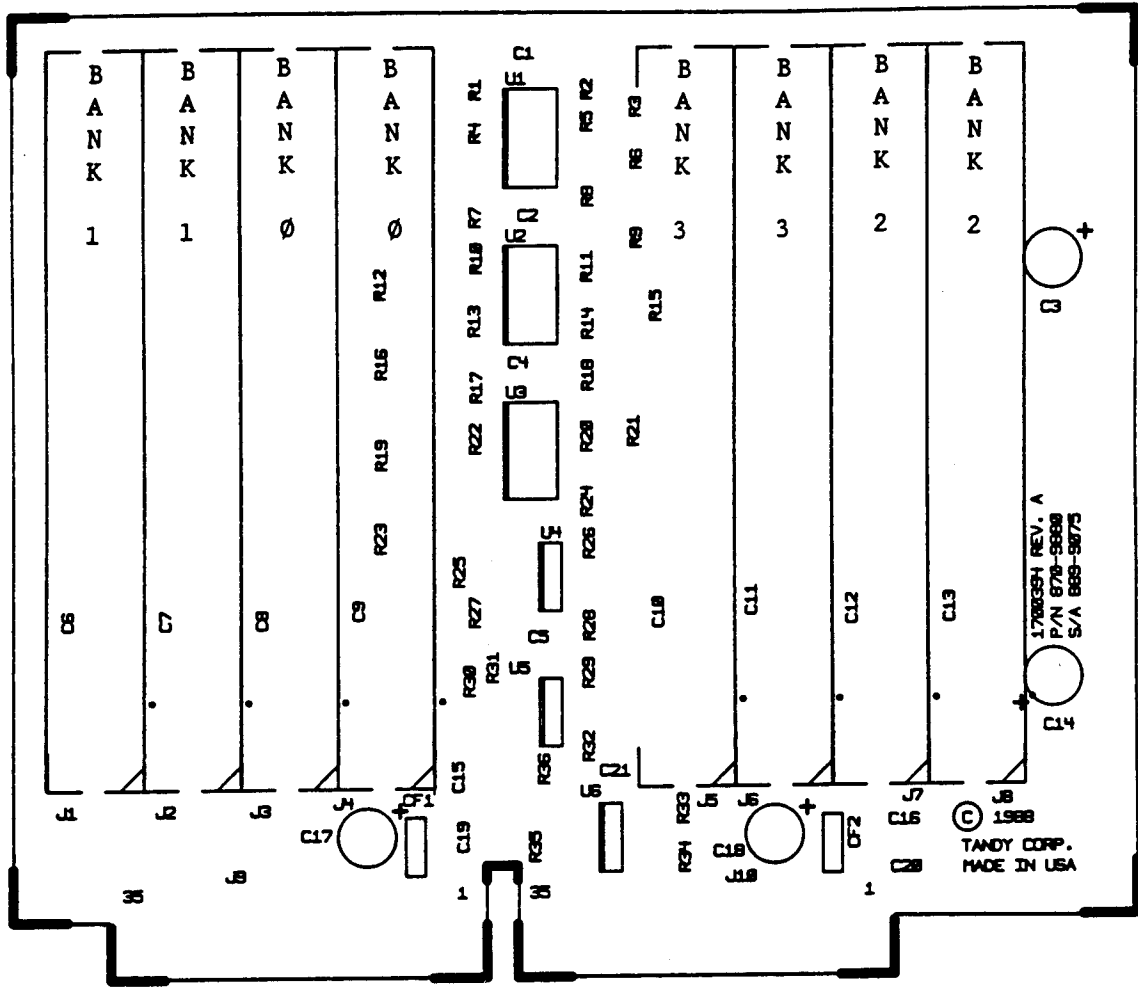

Figure 200. 0K Memory Expansion Adapter for Tandy 3000NL without jumper

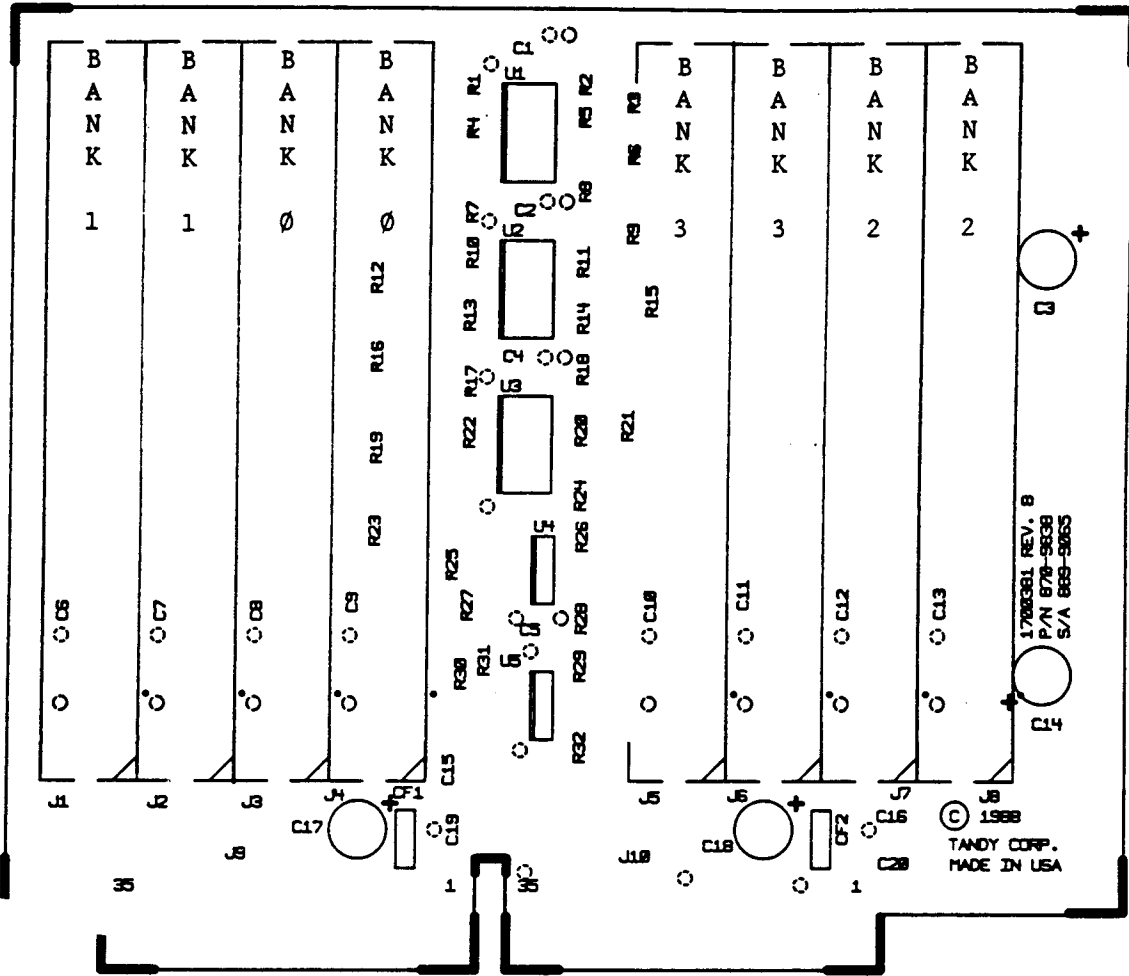

Figure 201. 0K Memory Expansion Adapter for Tandy 5000MC

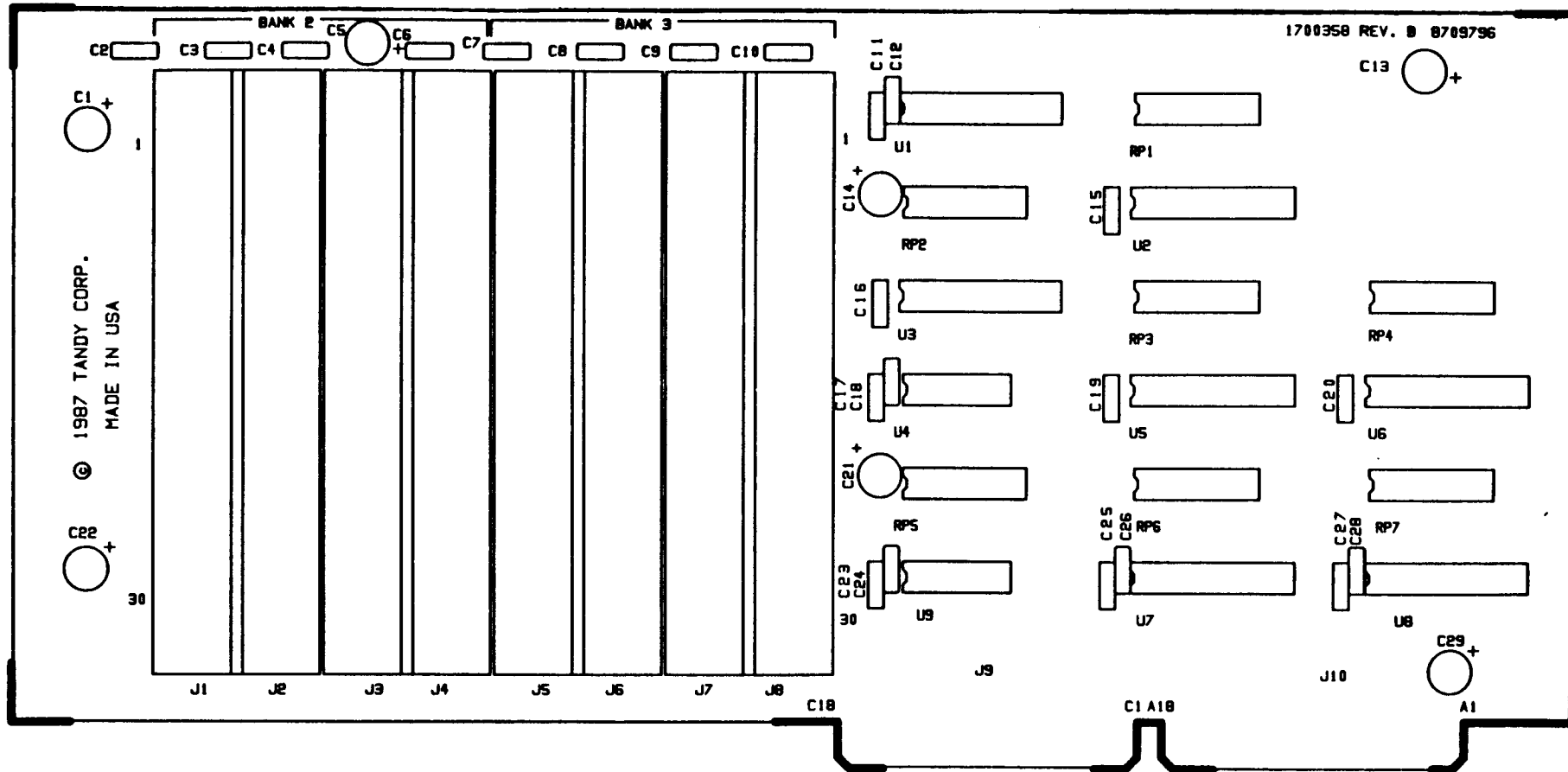
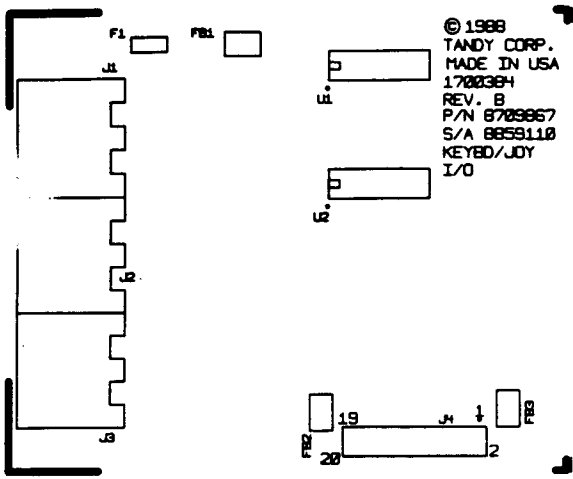
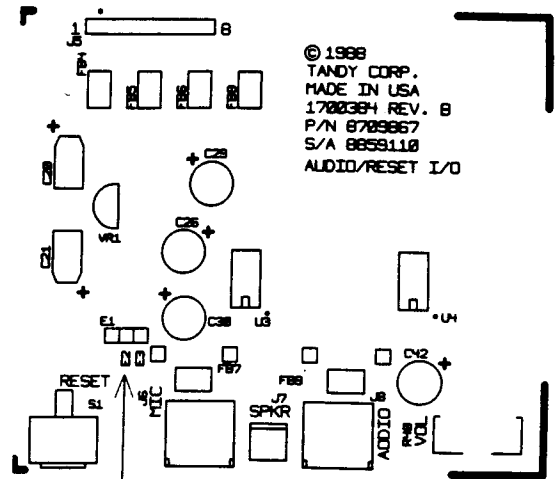

Figure 202. 32 Bit Memory Board for Tandy 4000/LX



Keyboard/Joystick Satellite Board



E1 - E2 connects line input to AUDIOIN
E2 - E3 connects mike input to AUDIOIN
Satellite Sound Board

E2 - E3 connects IRQ5 to the bus
E3 - E4 connects IRQ5 to VSYNC

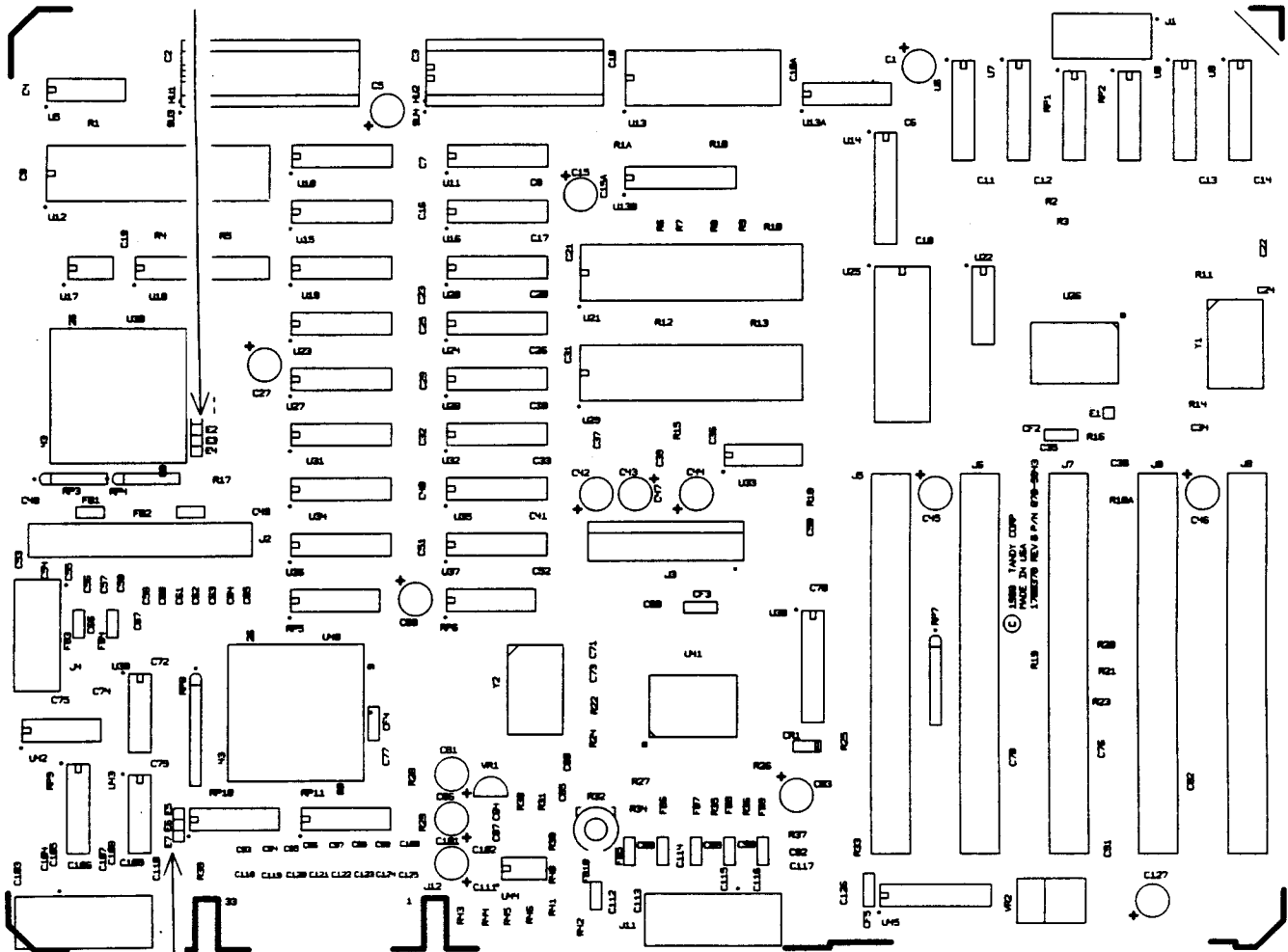

E5 - E6 connects SLCTIN* to the printer
E6 - E7 ties SLCTIN* high

Figure 203. Tandy 1000SL Main Logic Board

E1 - E2 connects IRQ5 to VSYNC
E2 - E3 connects IRQ5 to expansion bus

E4 - E5 on connects SLCTIN* to printer
off ties SLCTIN* high

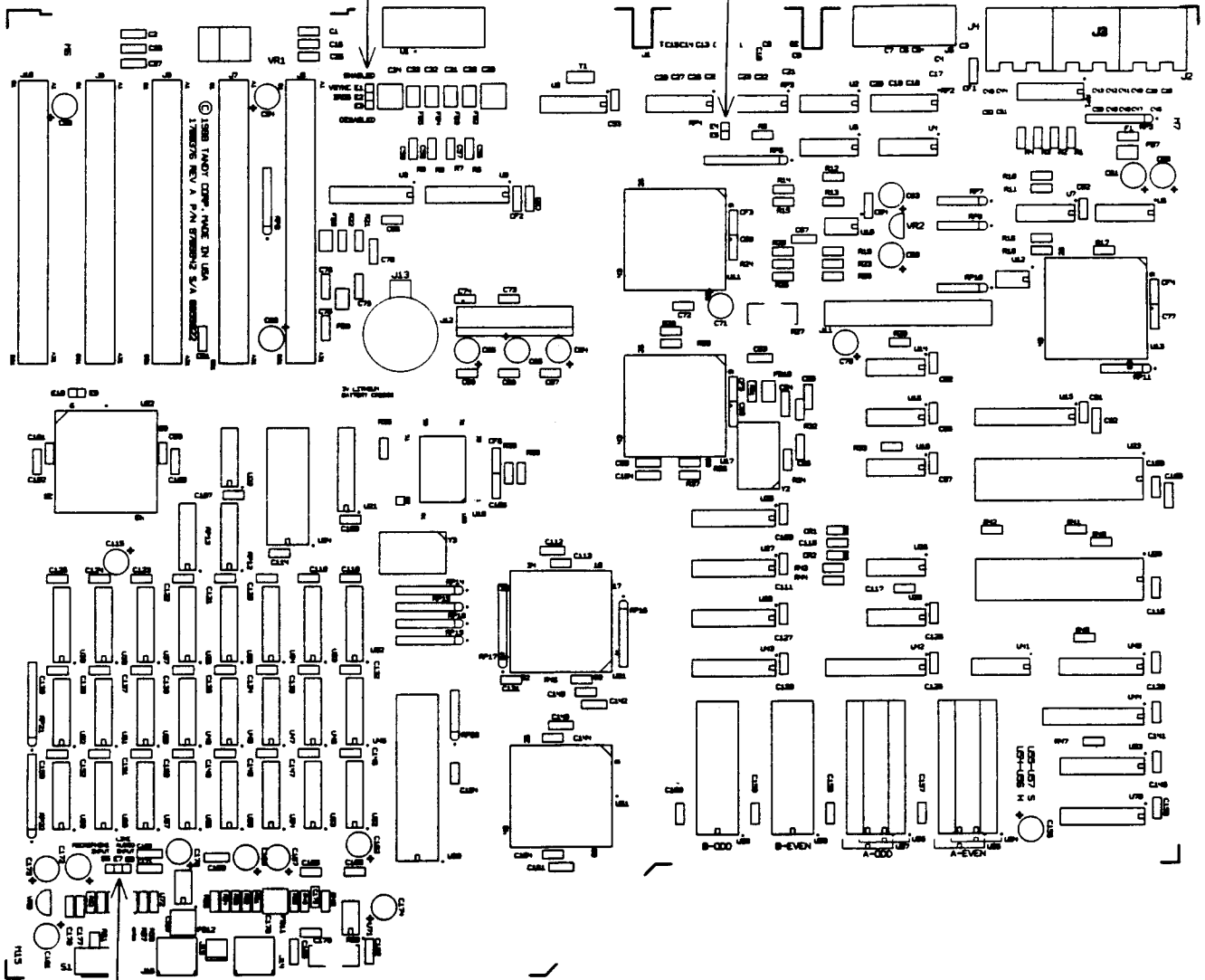

E6 - E7 connects microphone input to AUDIOIN
E7 - E8 connects line input to AUDIOIN

Figure 204. Tandy 1000TL Main Logic Board

E11 - E12
See text

E1 - E2
E3 - E4
See text

See text
Switch S2

E7 - E8
E9 - E10
See text

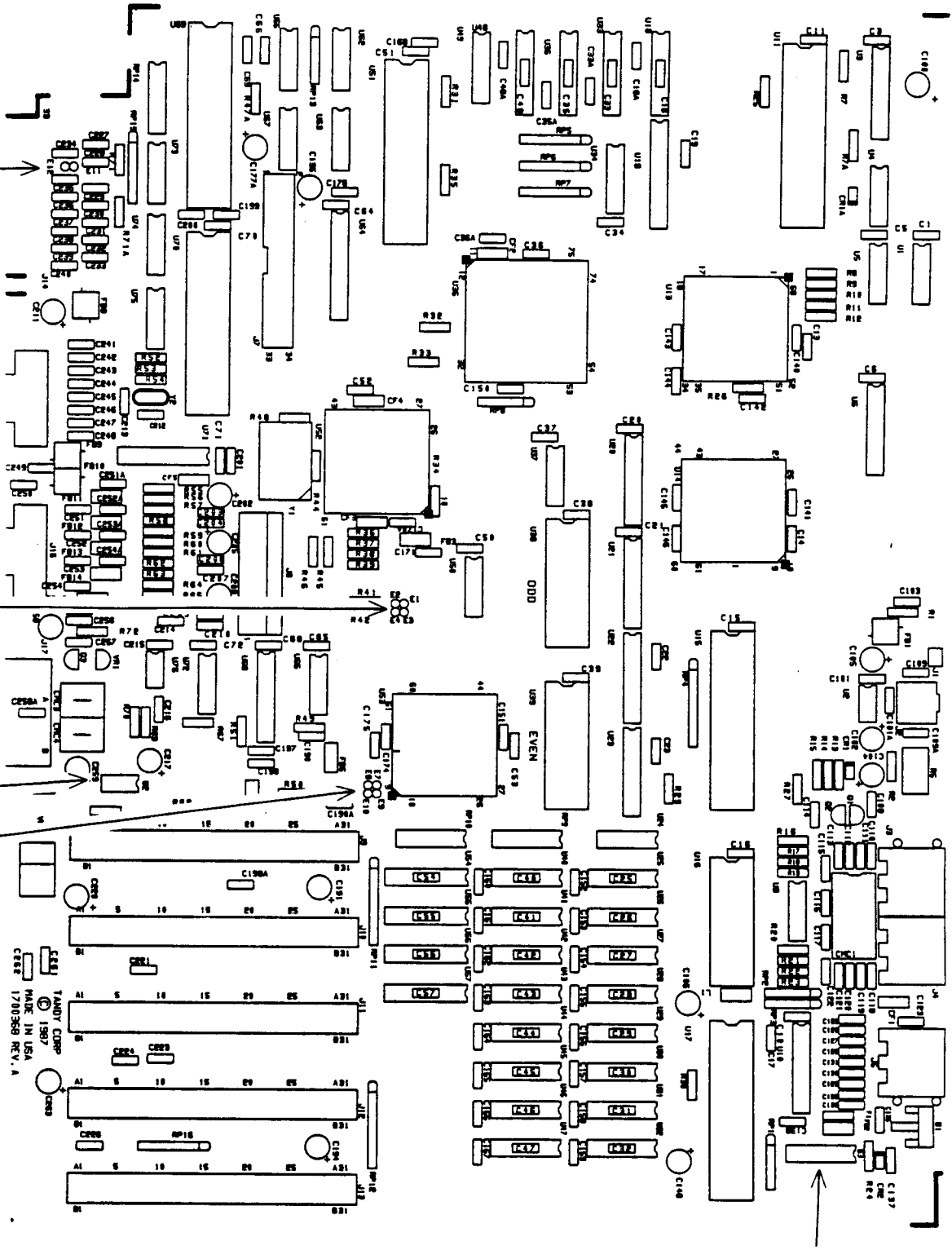

Switch S3
See text

Figure 205. Tandy 1000TX Revision A (Cleburn Version)

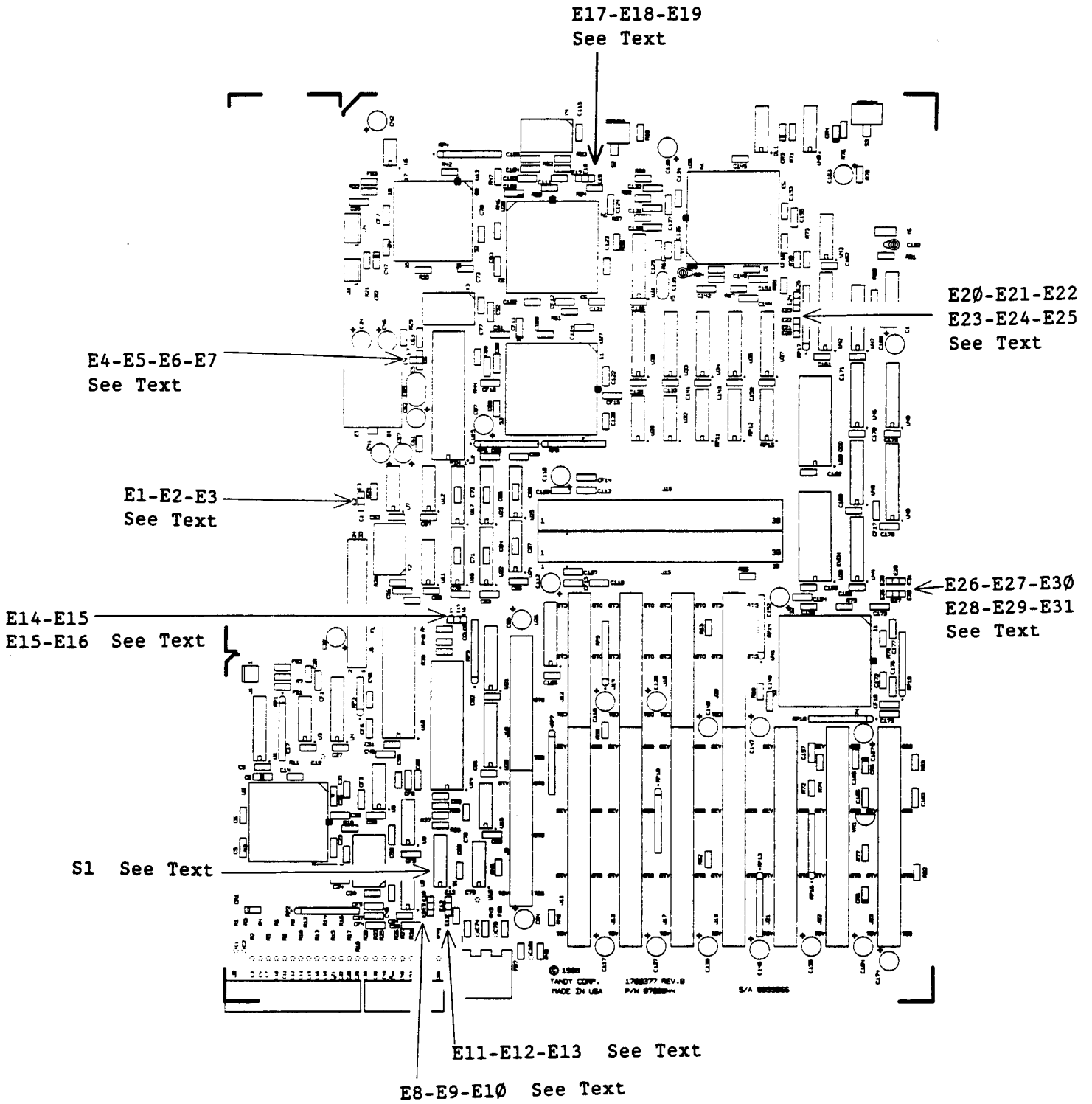

Figure 206. Tandy 3000NL Main Logic Board

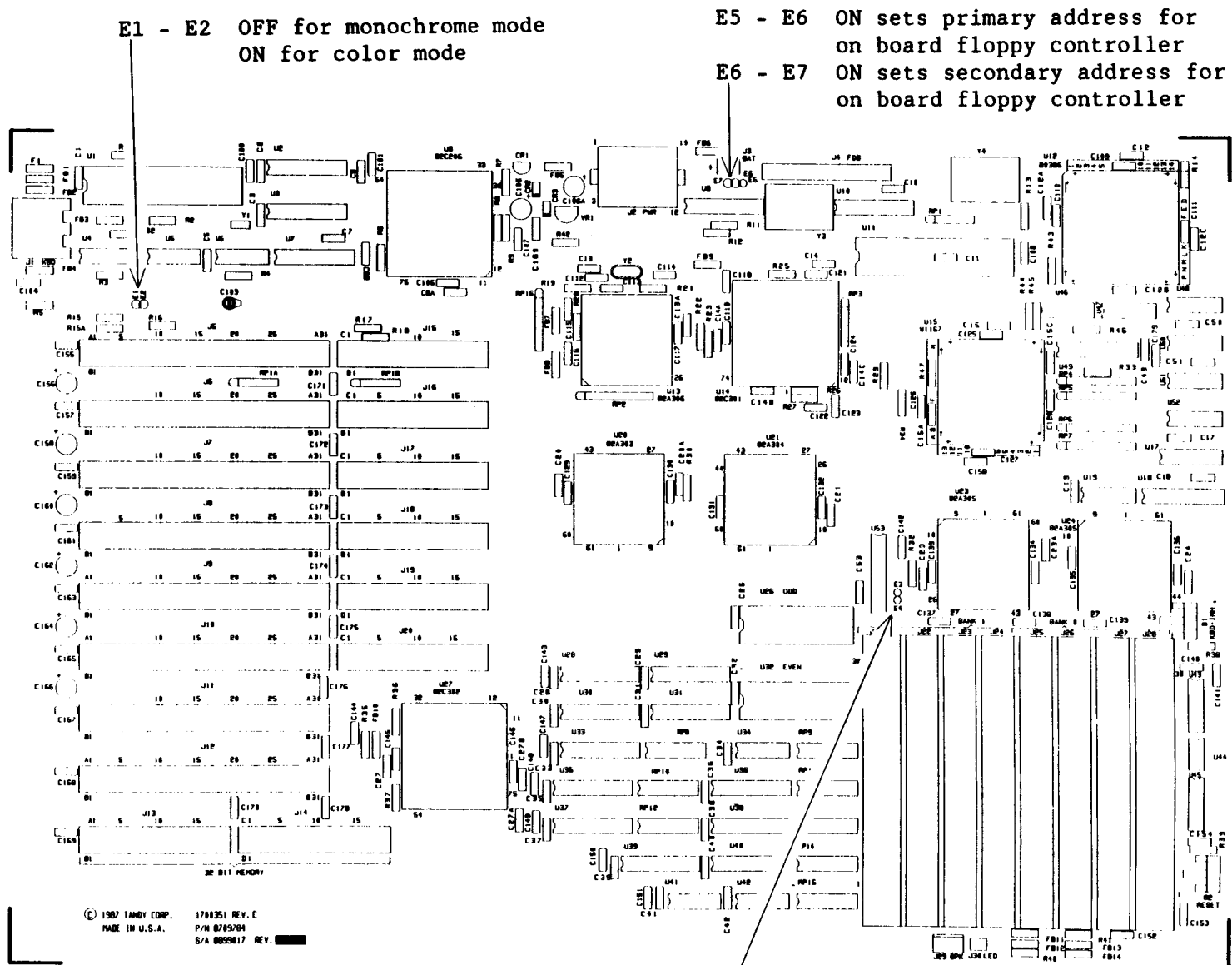

Figure 207. Tandy 4000LX Main Logic Board
Revision C, C-1

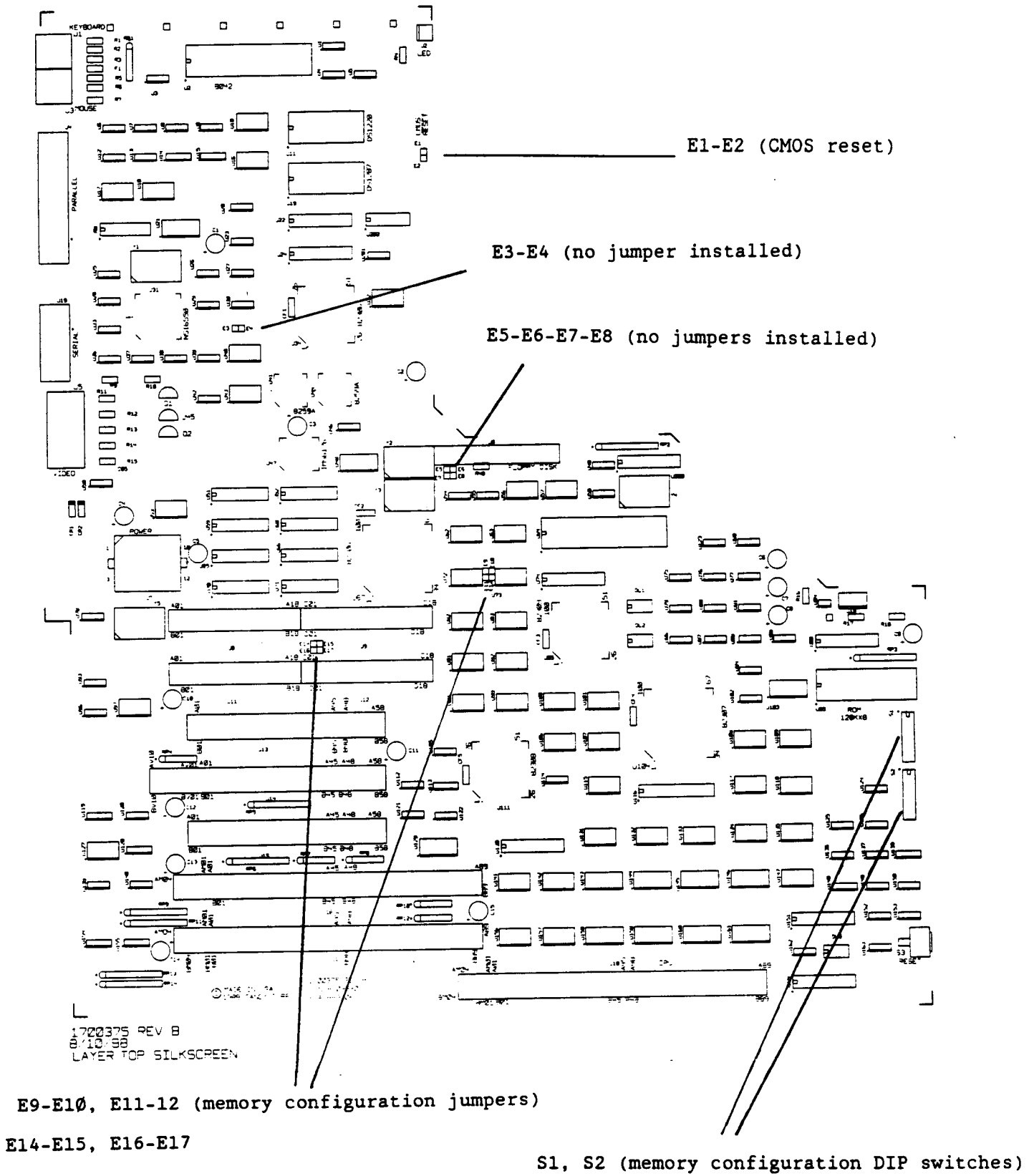

Figure 208. Tandy 5000MC Main Logic Board

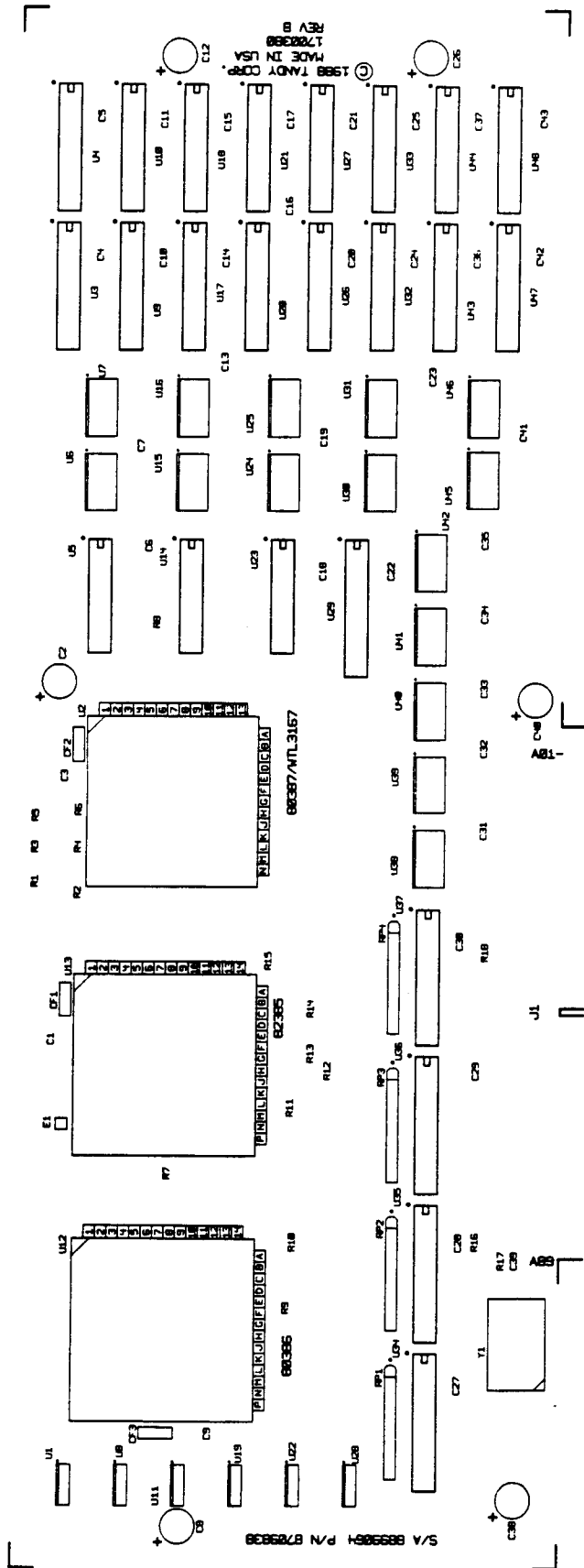

Figure 209. Tandy 5000MC CPU Board

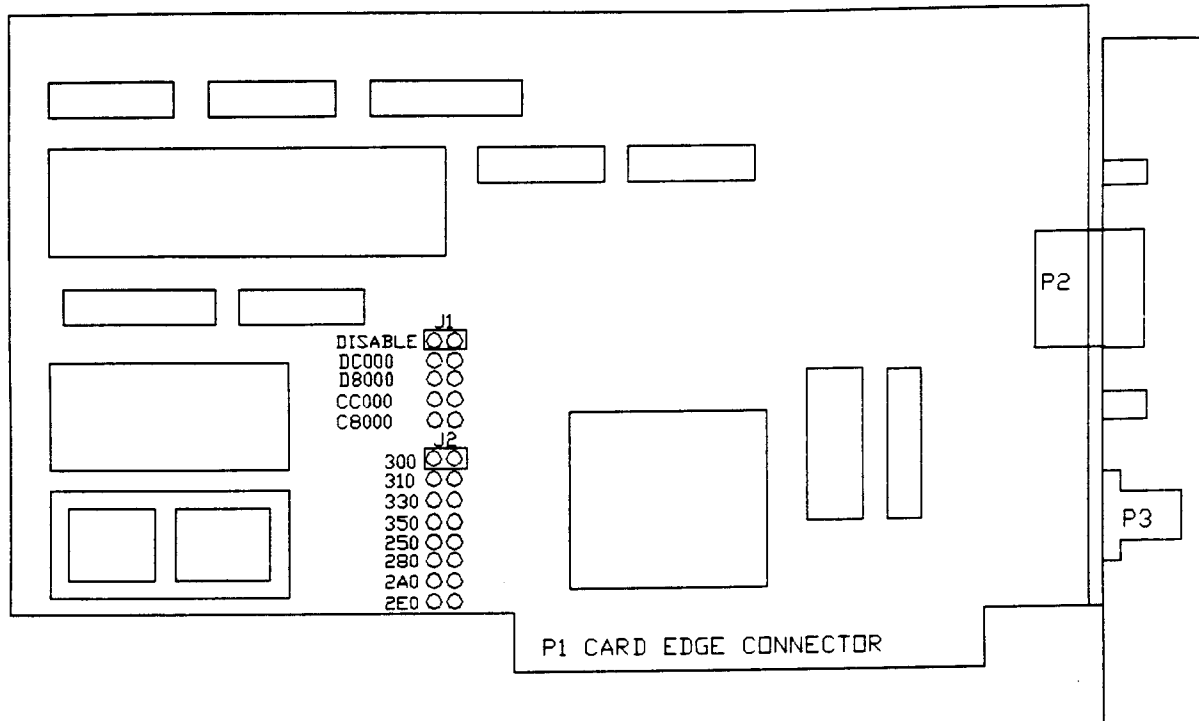

Figure 210. ETHERLINK II Interface Board

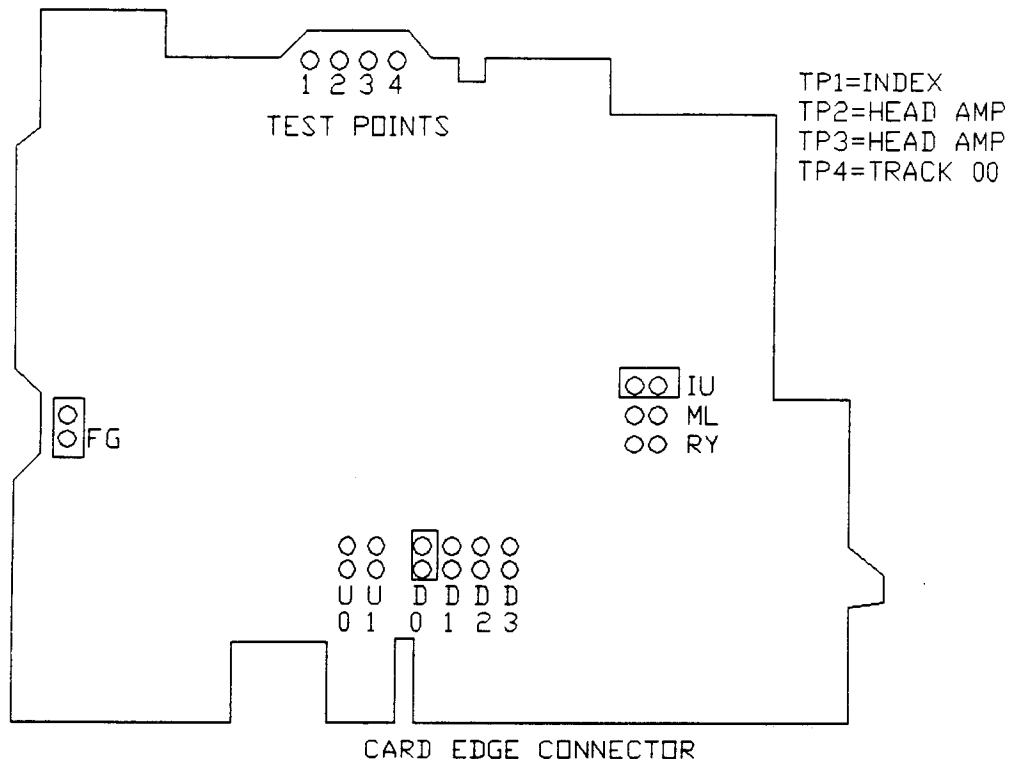

Figure 211. Teac 5 1/4" Floppy Drive FD55BR-121

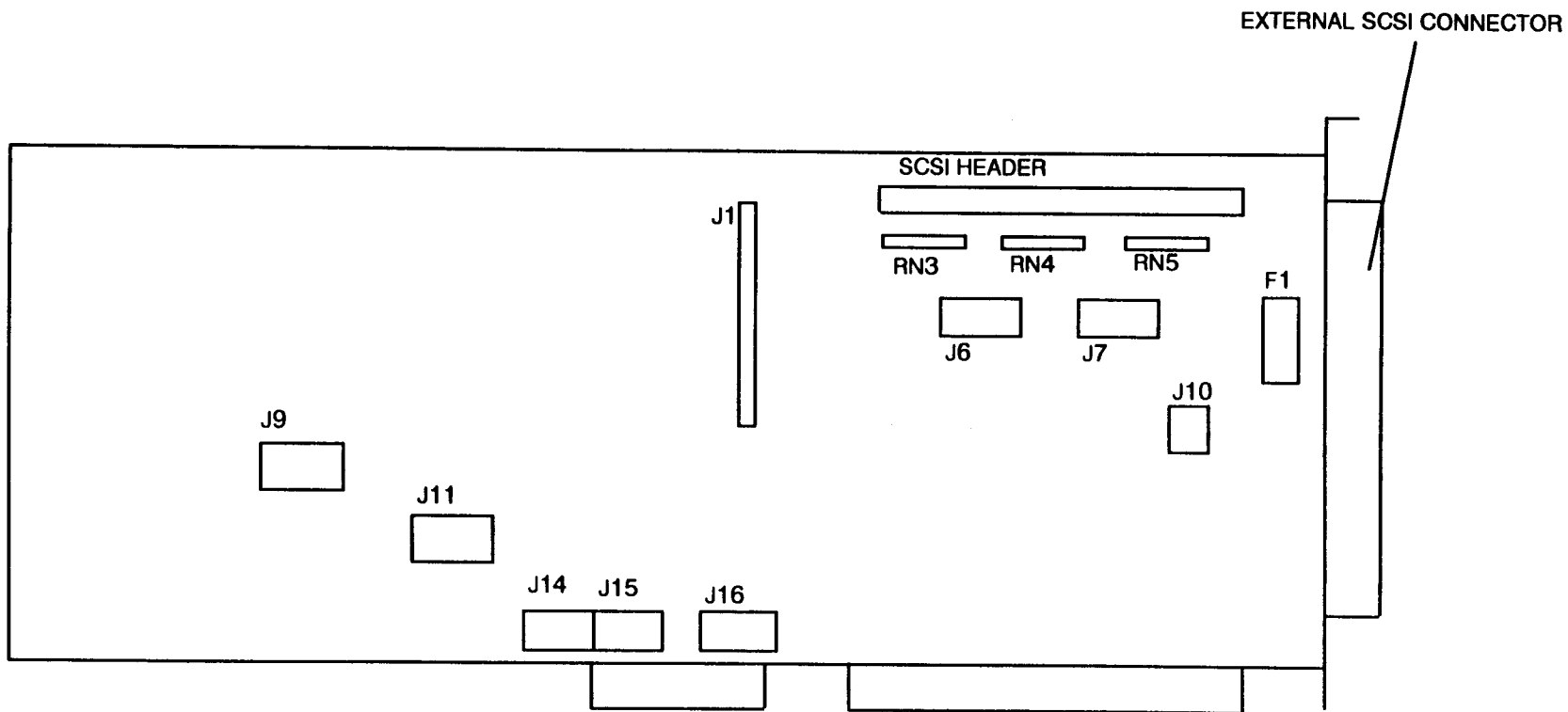

Figure 212. 16 Bit SCSI Hard Drive Adapter Board 25-4161B

BOTTOM VIEW

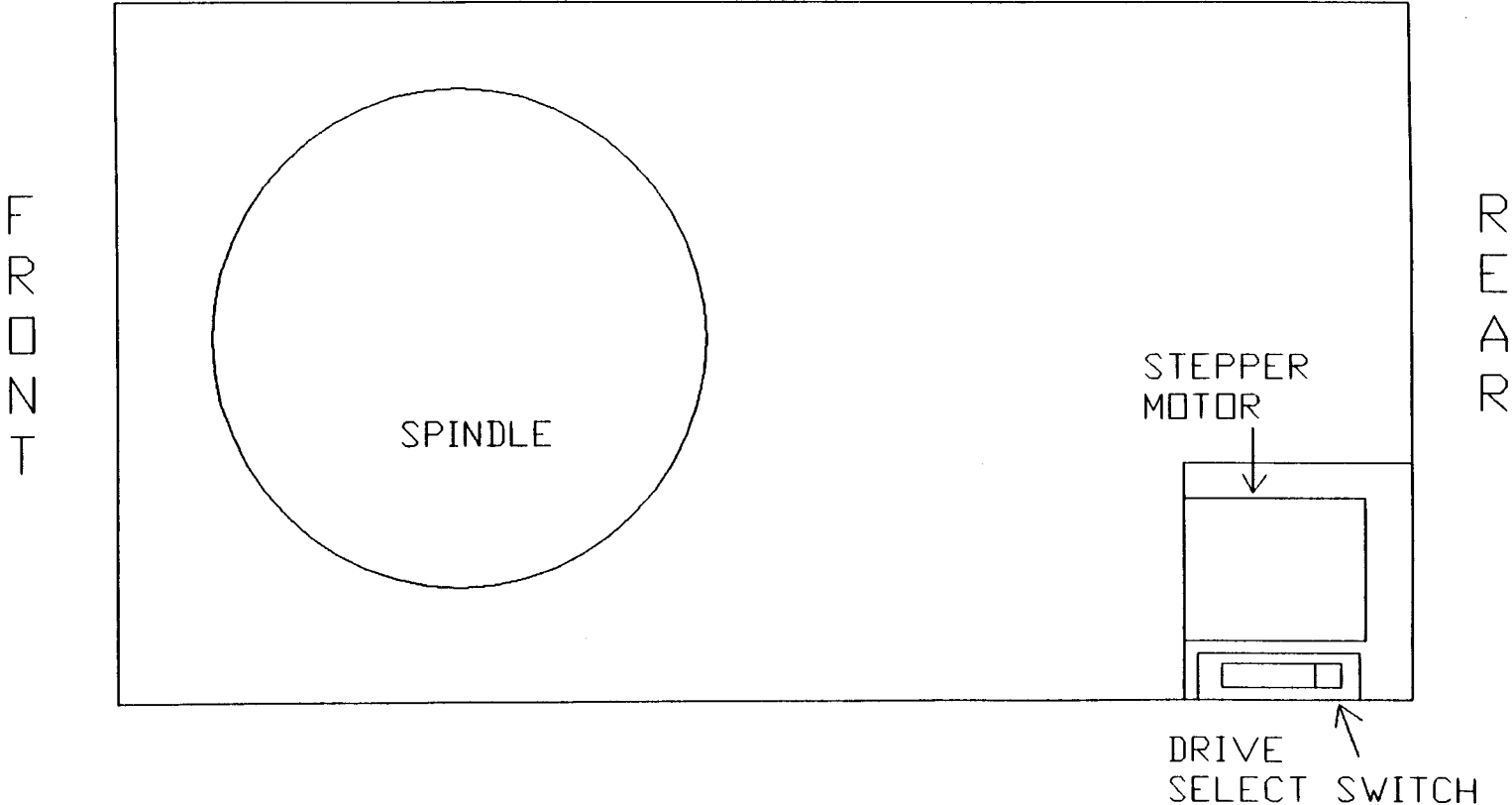

Figure 213. Citizen OPBD-12A 3 1/2" Floppy Drive 720K

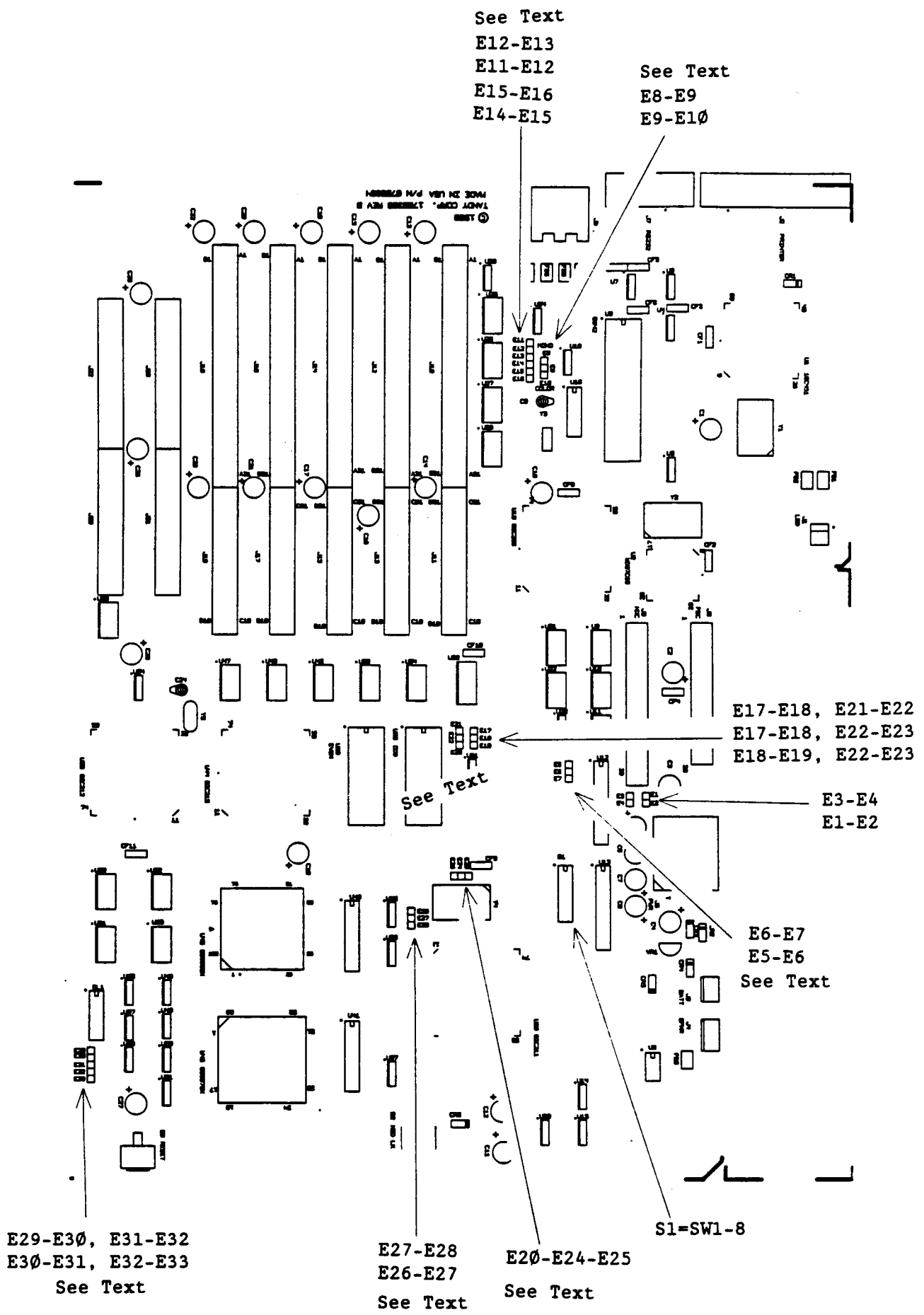

Figure 214. Tandy 4000SX Main Logic Board

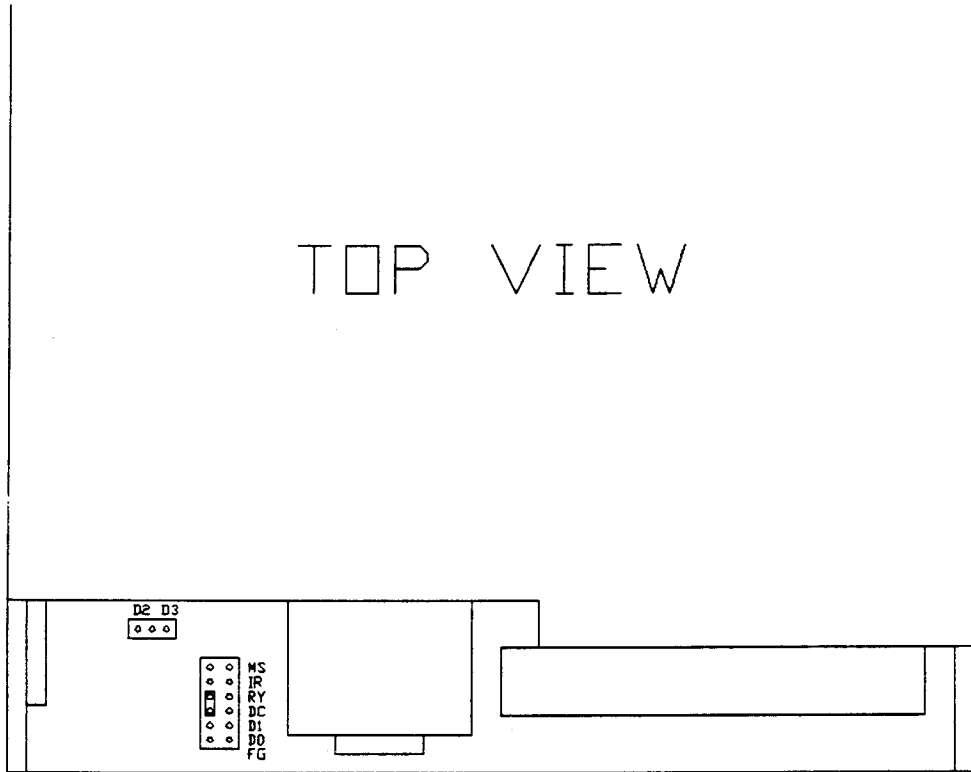

Figure 215. Teac FD235-105U 3 1/2" Floppy Drive 720K

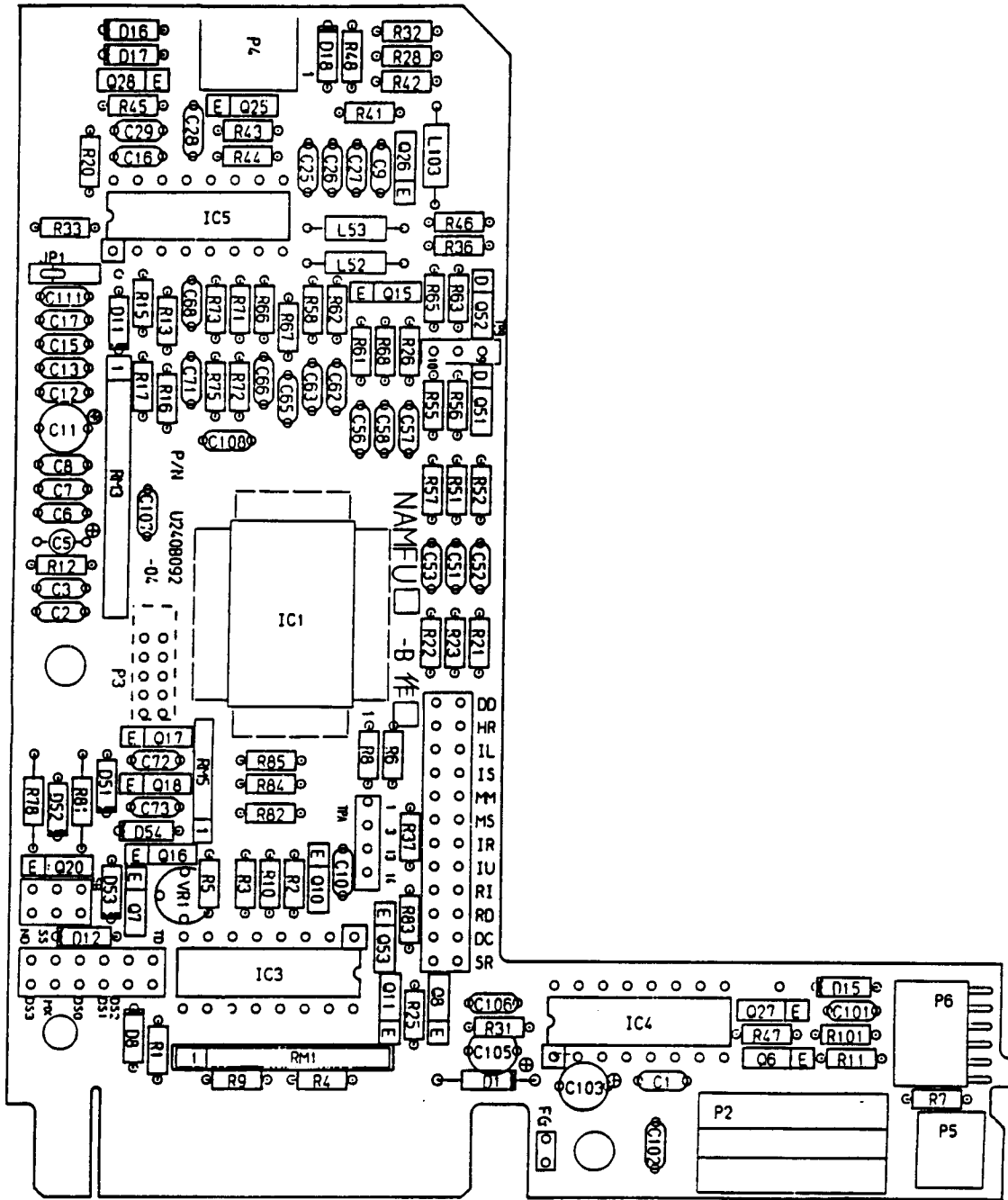

Figure 216. Mitsubishi MF504C-347UA 5 1/4" Floppy Drive 1.2M

Solder Side

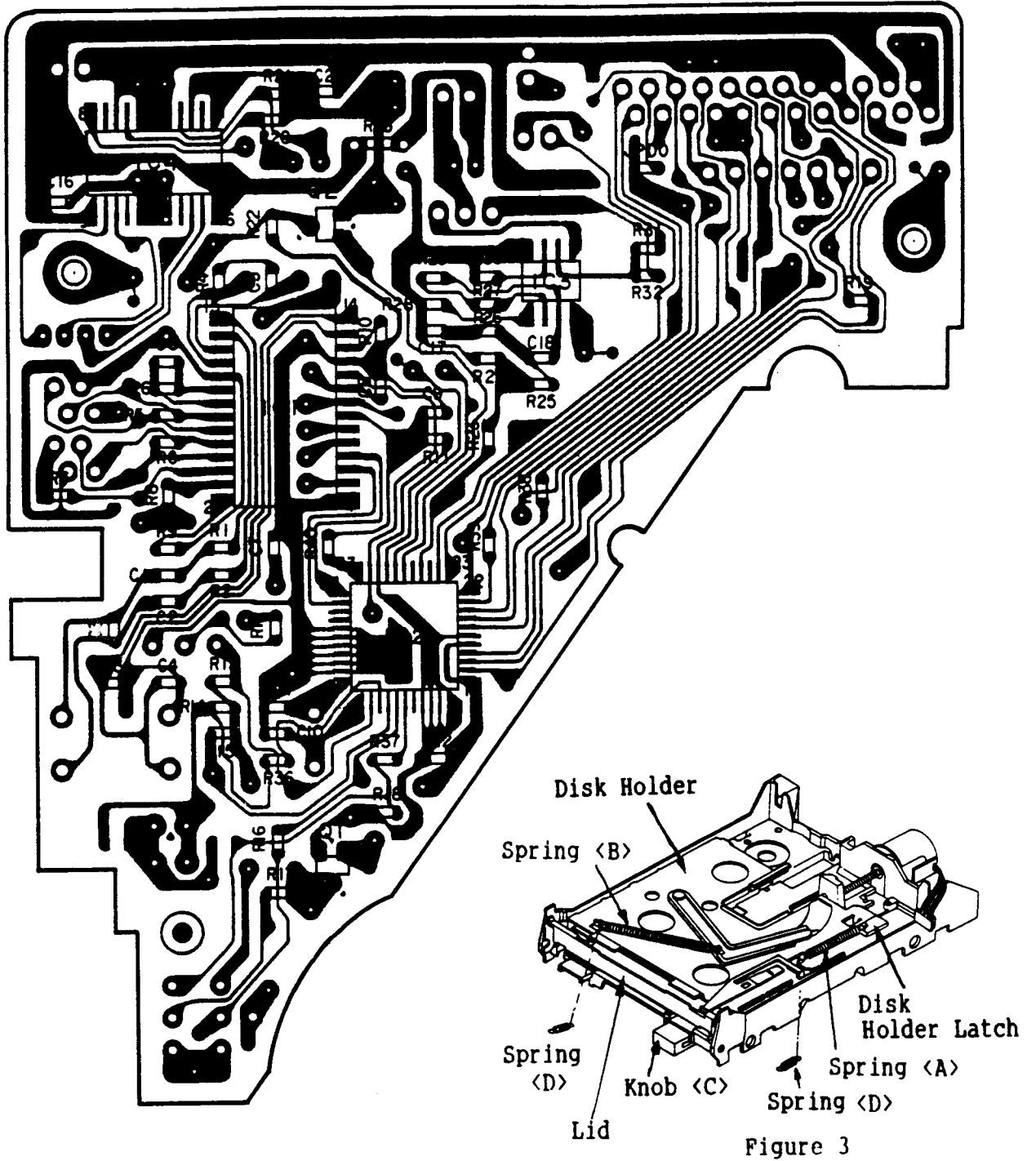

Figure 217. EME-213 3 1/2" Floppy Drive 720K

TOP VIEW

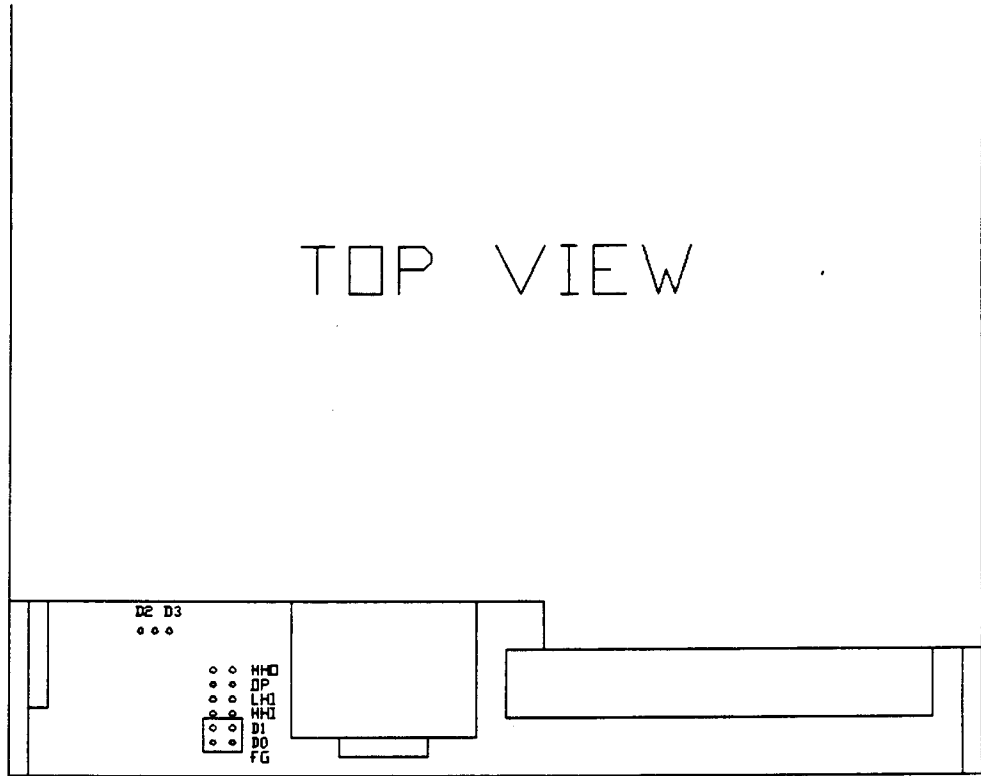
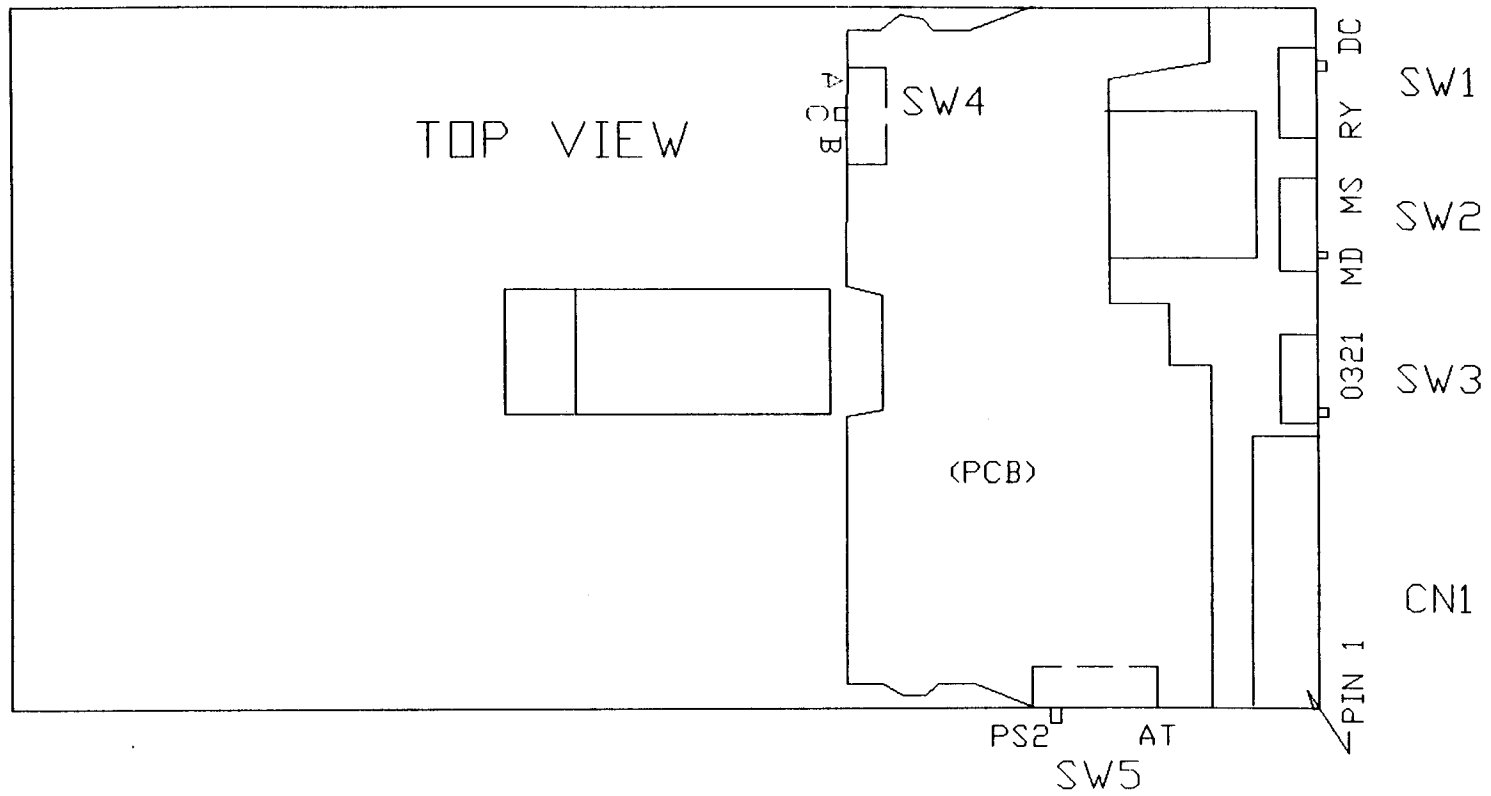

Figure 218. Teac FD235-136U 3 1/2" Floppy Drive 720K



NOTE: SW4 and SW5 are not visible. PCB must be removed.

Figure 219. Panasonic JU-257A213P 1.44 MEG Floppy Drive for Tandy 2800HD

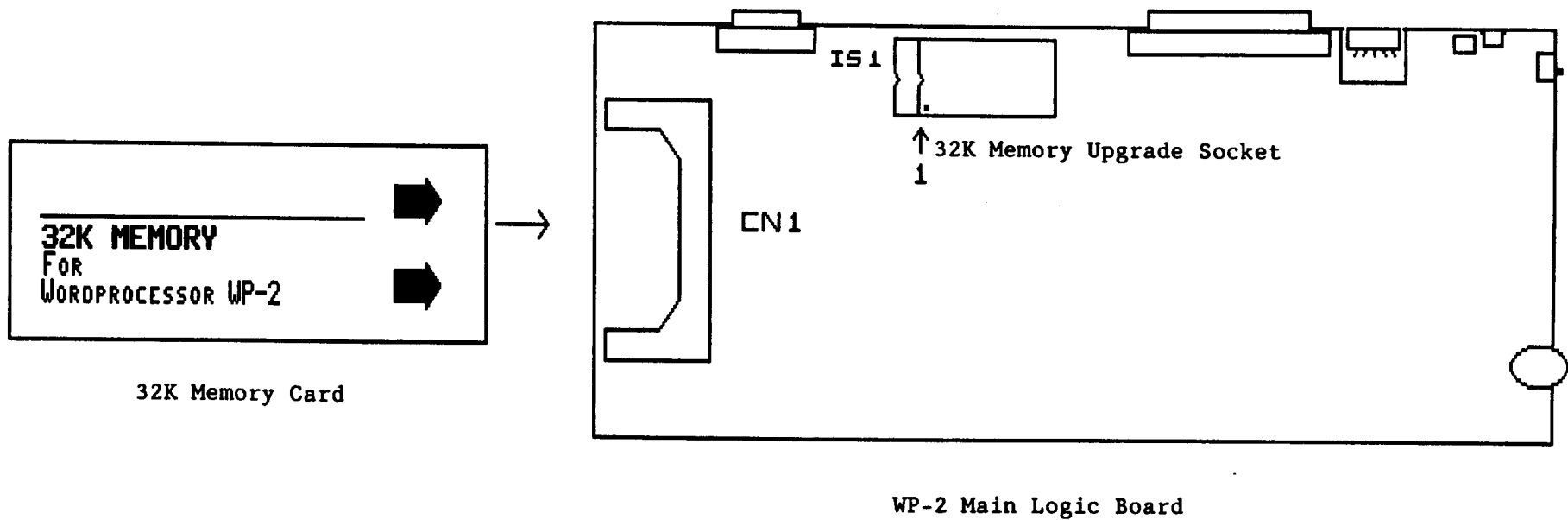

Figure 220. WP-2 Main Logic Board
32K Memory Card Upgrade
32K Memory IC Upgrade

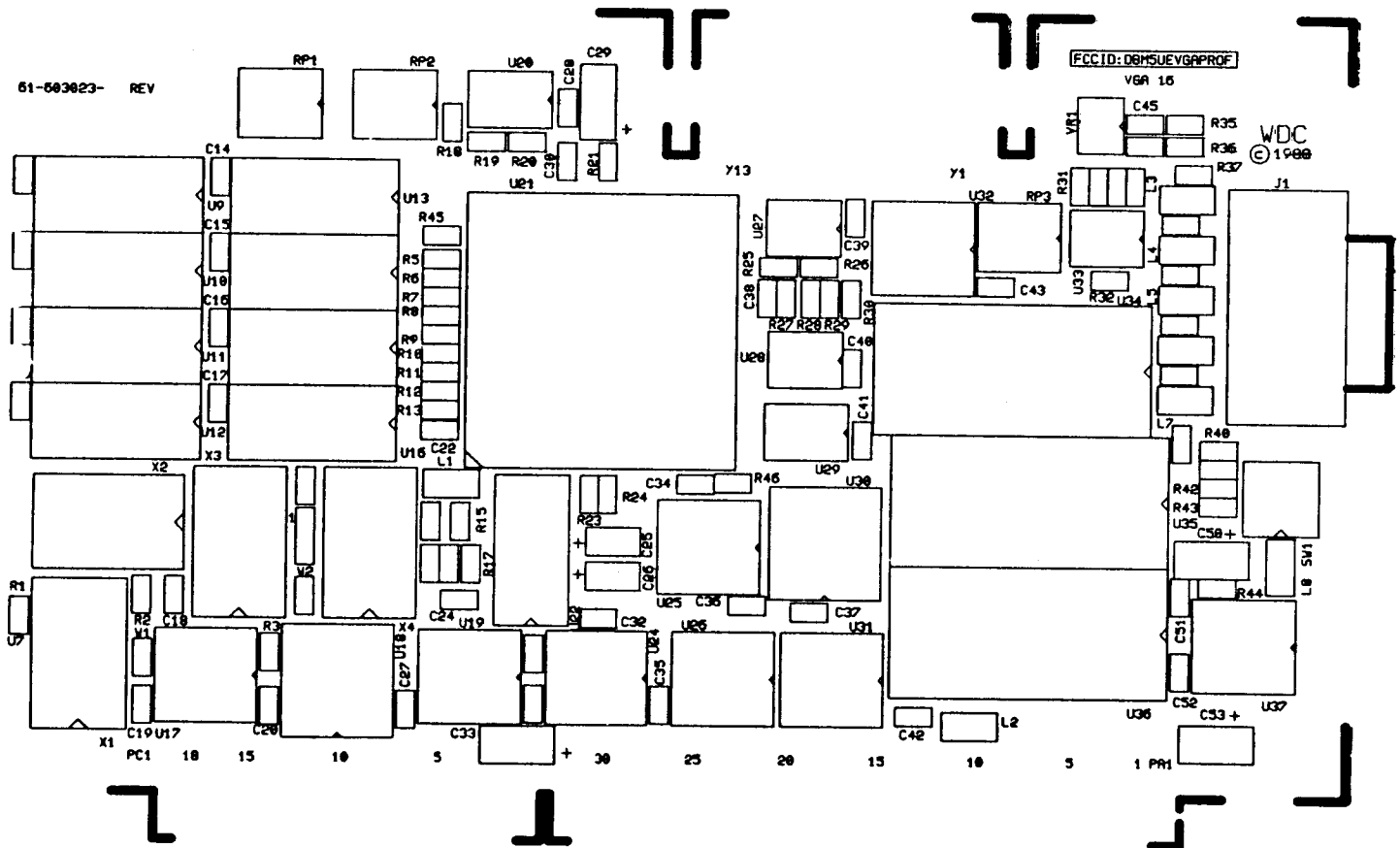

Figure 221. 16 Bit VGA Adapter Board

LED (NOT USED)

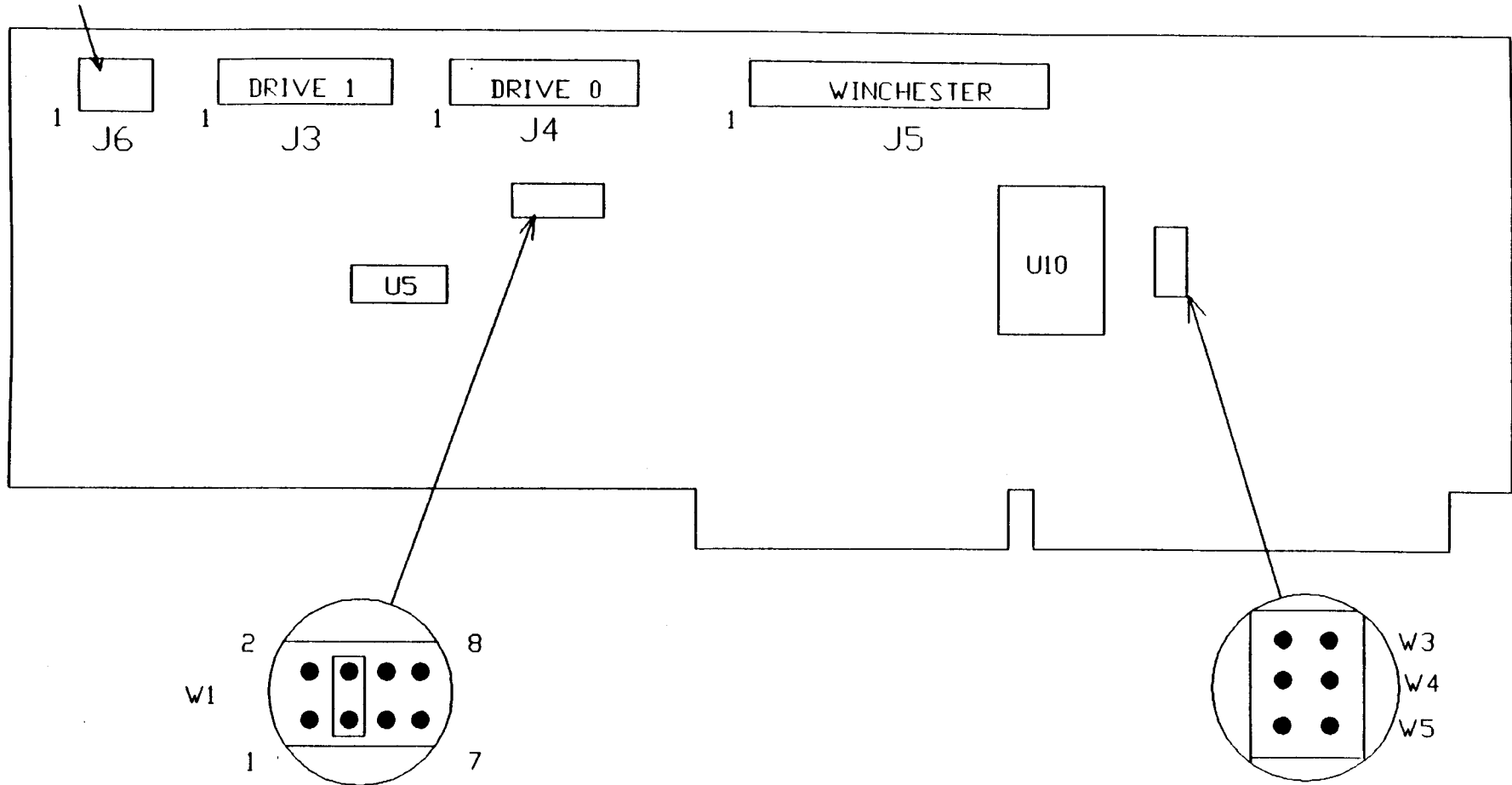
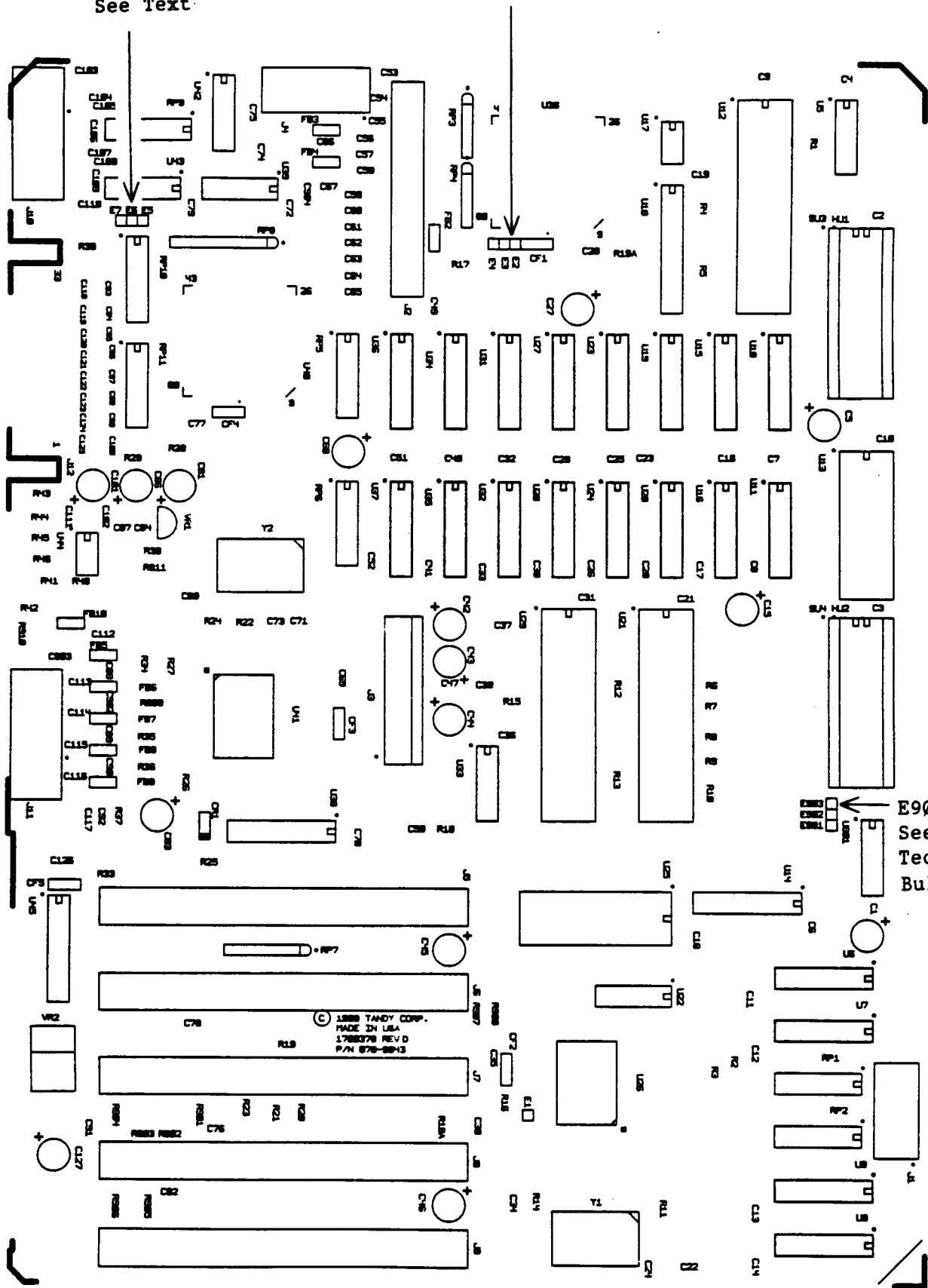

Figure 222. Western Digital WD1003V-MM1 16-bit Hard Drive Controller

E5-E6
E6-E7
See Text

E2-E3
E3-E4
See Text



E901-E902-E903
See Text and
Technical
Bulletin 1000:4

Figure 224. Tandy 1000SL/2 Revision D Main Logic Board

E12-E13-E14
See Text

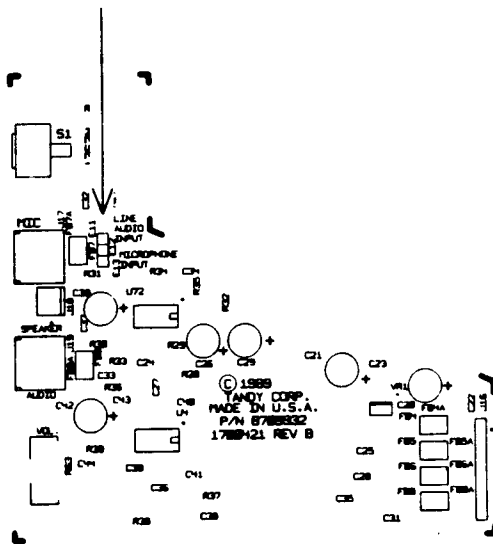

Audio Interface Board

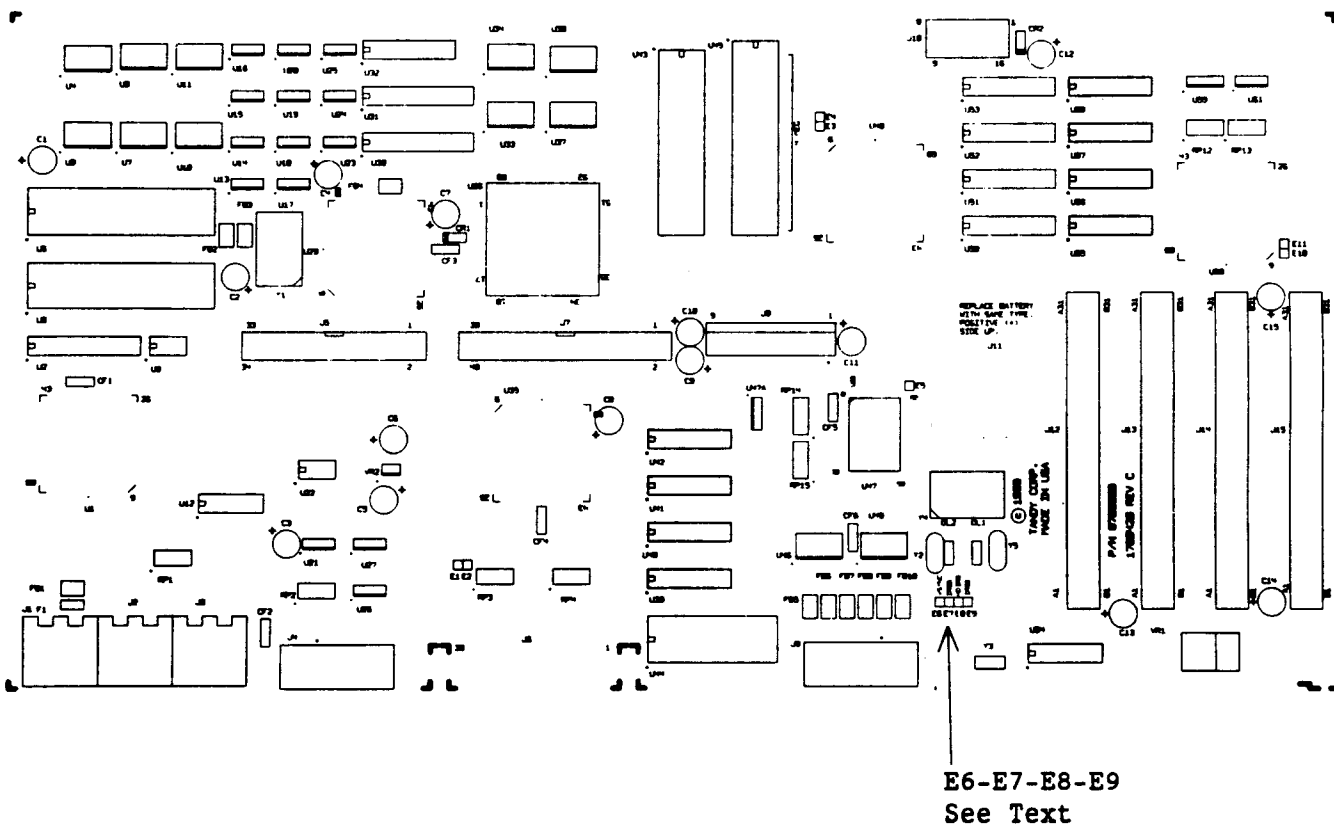

Figure 225. Tandy 1000TL/2 Main Logic Board

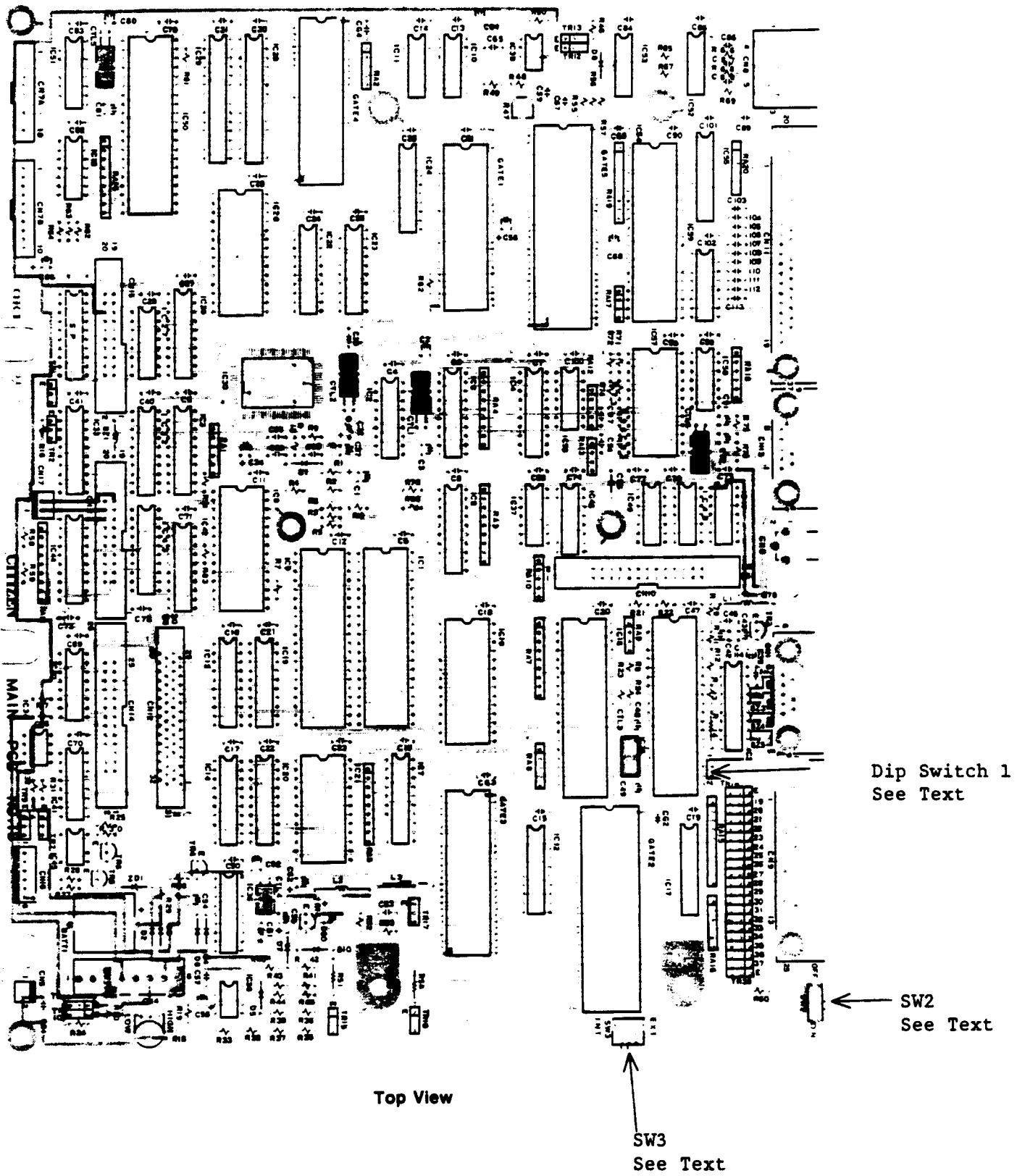

Figure 226. Tandy 1400LT/A Main Logic Board

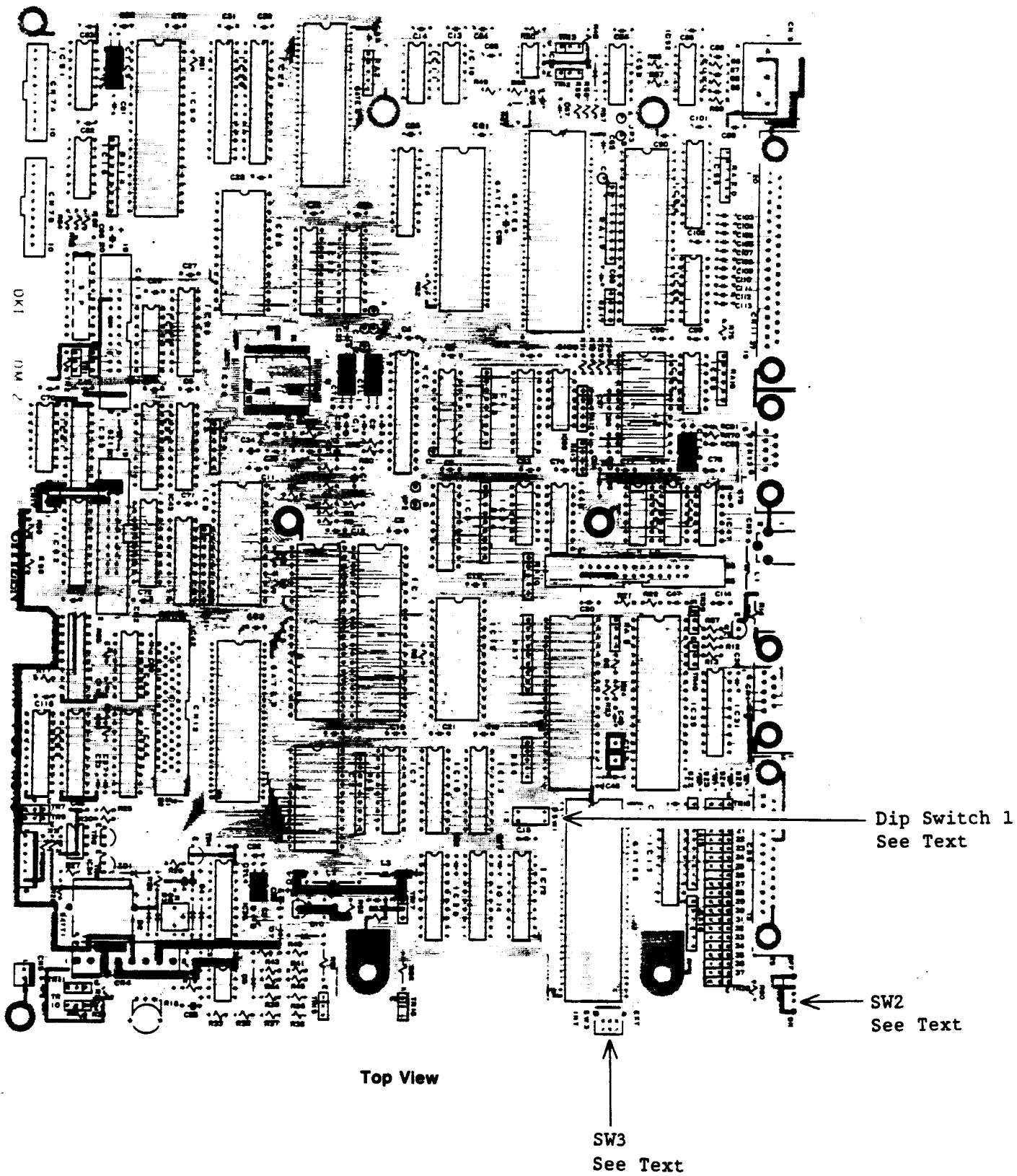

Figure 227. Tandy 1400LT "B" Version Main Logic Board

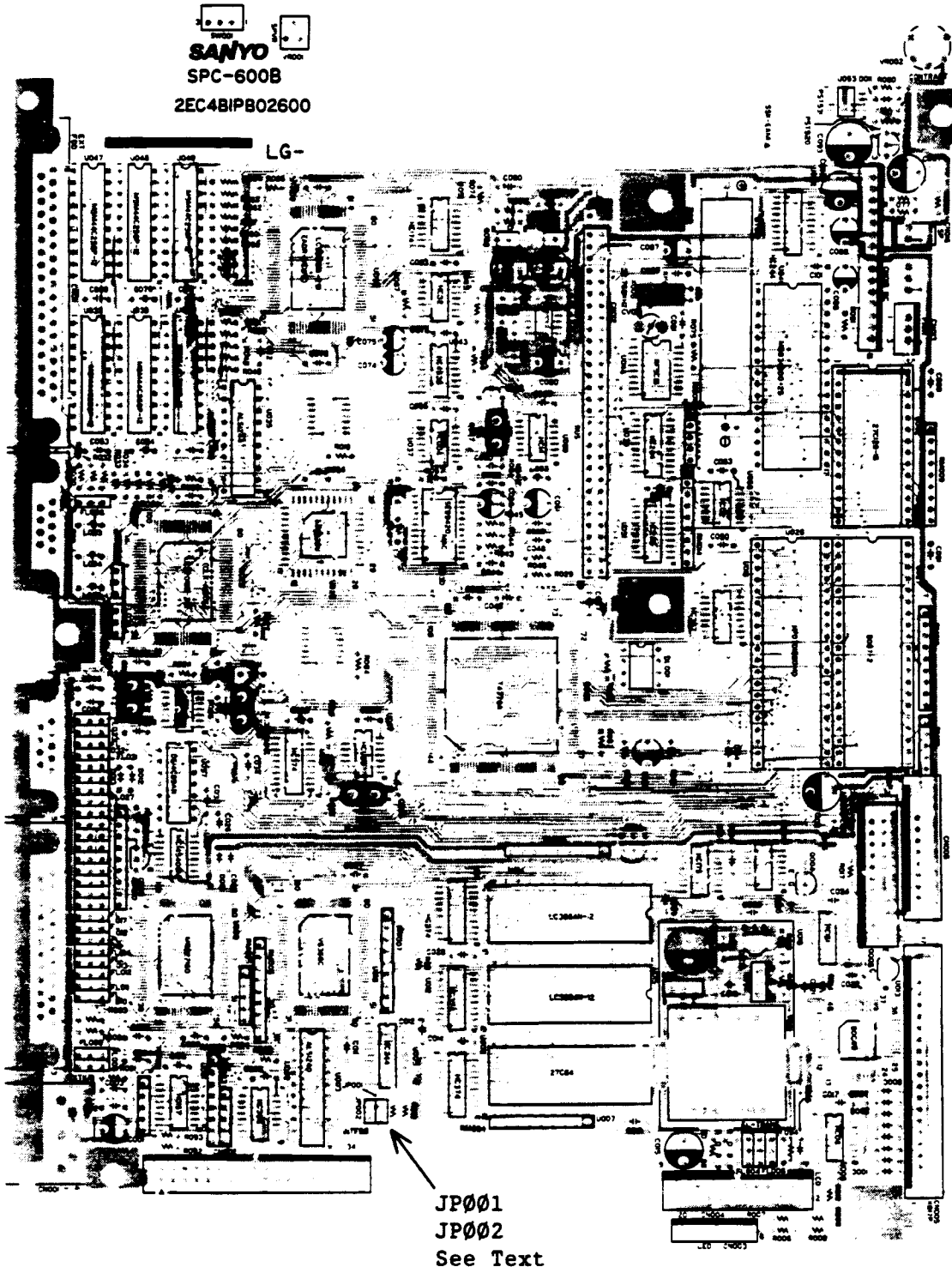

Figure 228. Tandy 1400FD/HD Main Logic Board

TOP VIEW

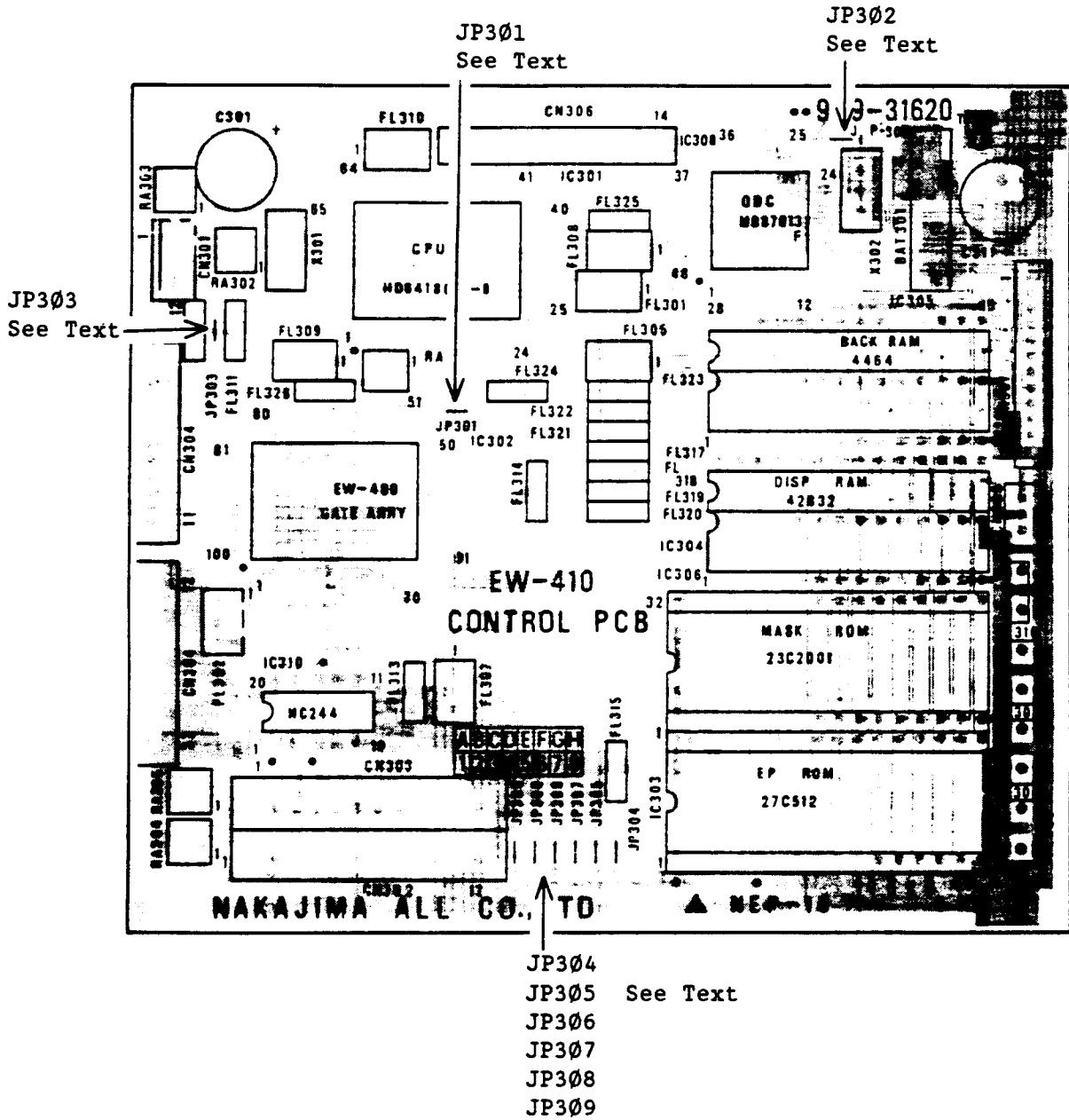

Figure 229. WP-100 Main Logic Board

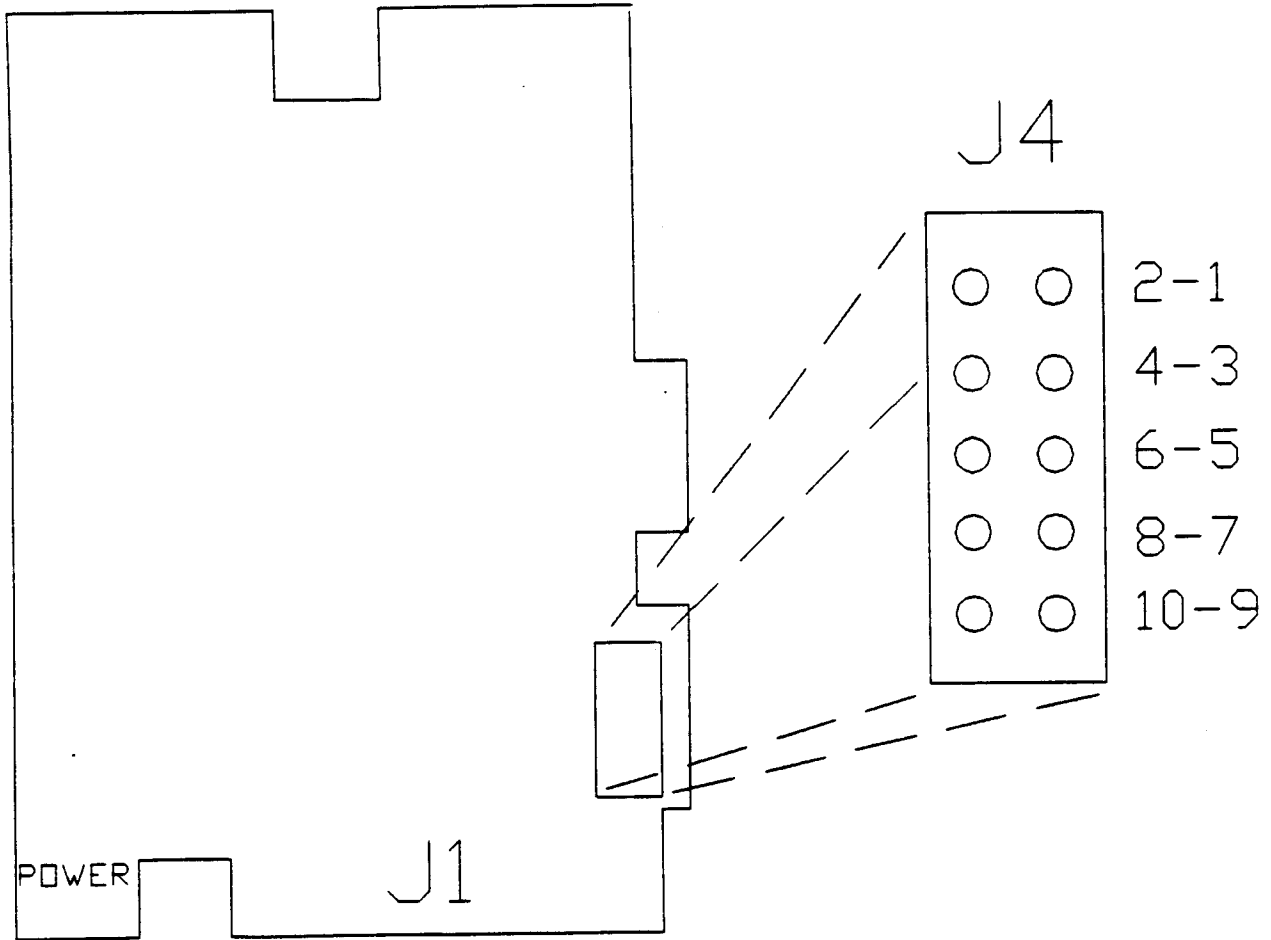

Figure 230. 40 MEG Miniscribe 8051A Smart Drive

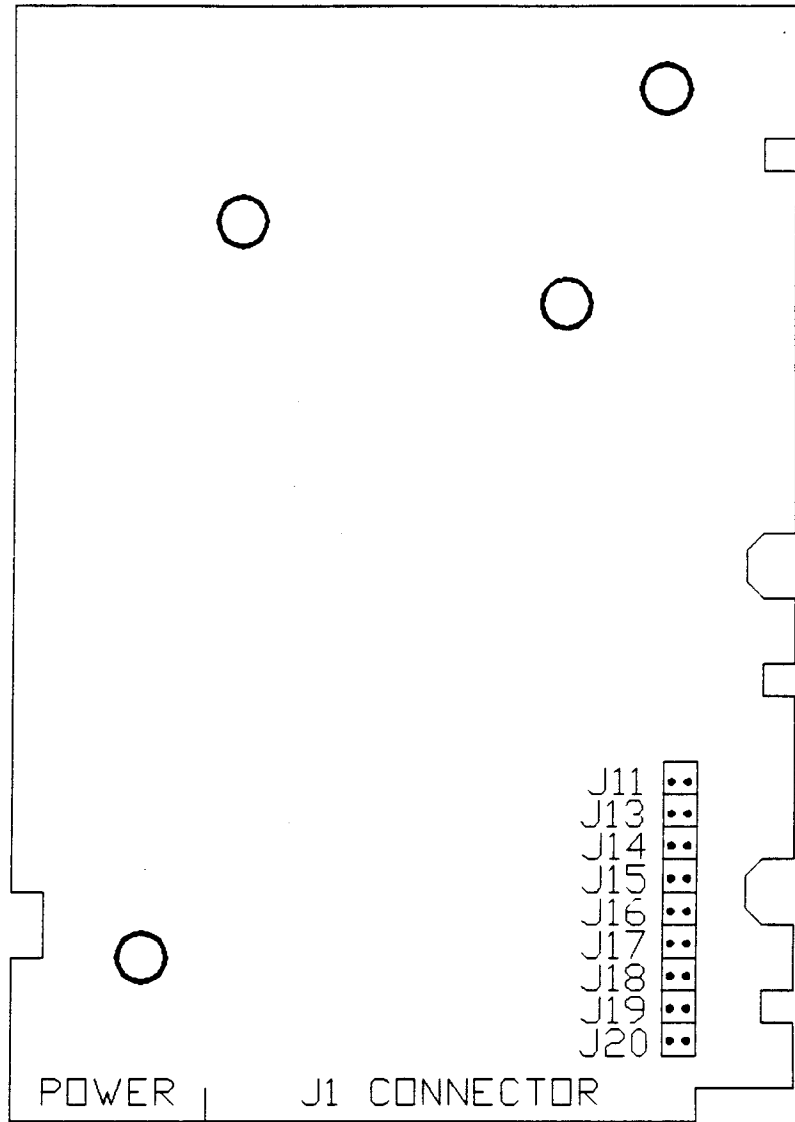

Figure 231. 80 MEG Miniscribe 7080A Smart Drive

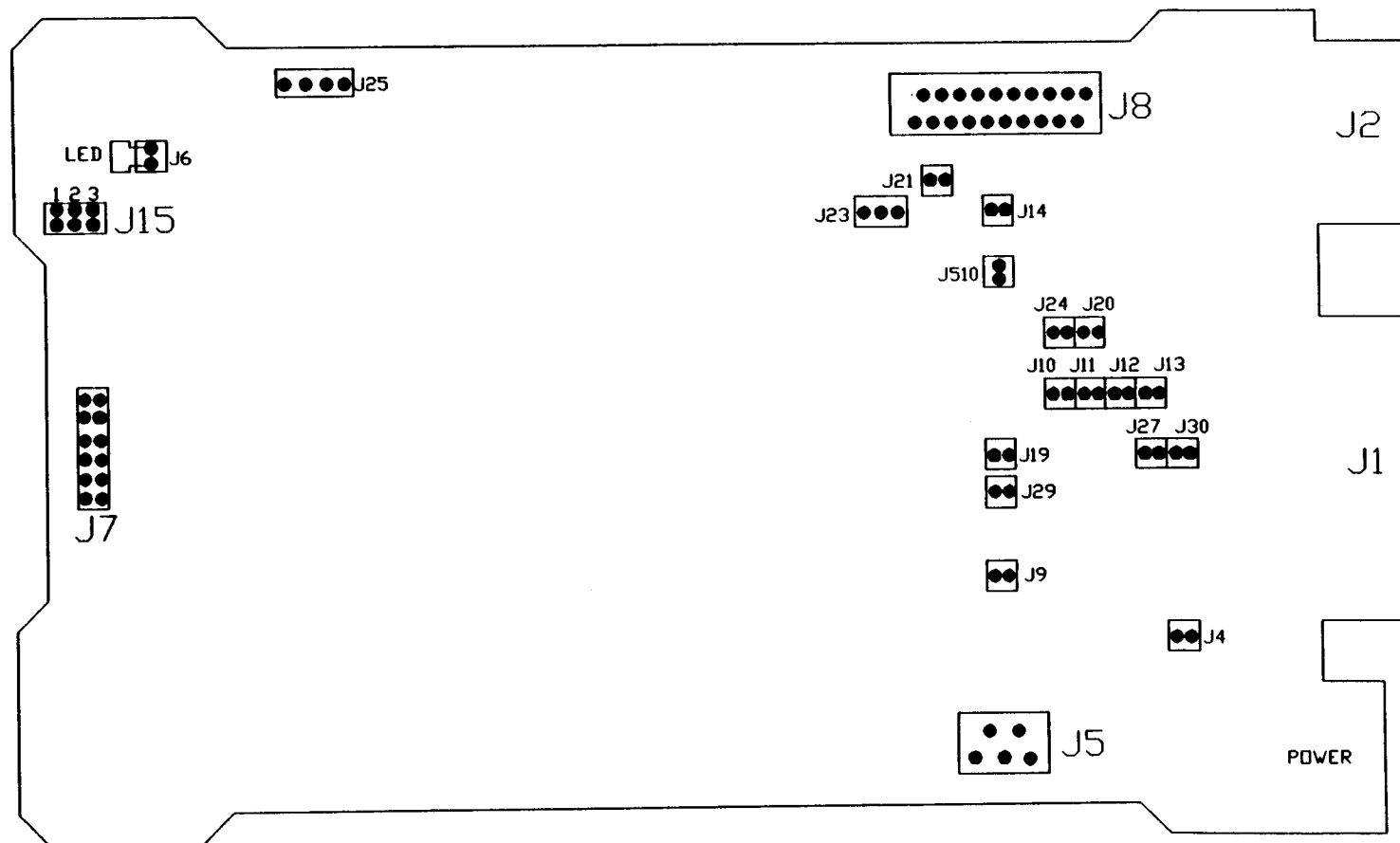

Figure 232. 150 MEG Half Height ESDI Hard Drive

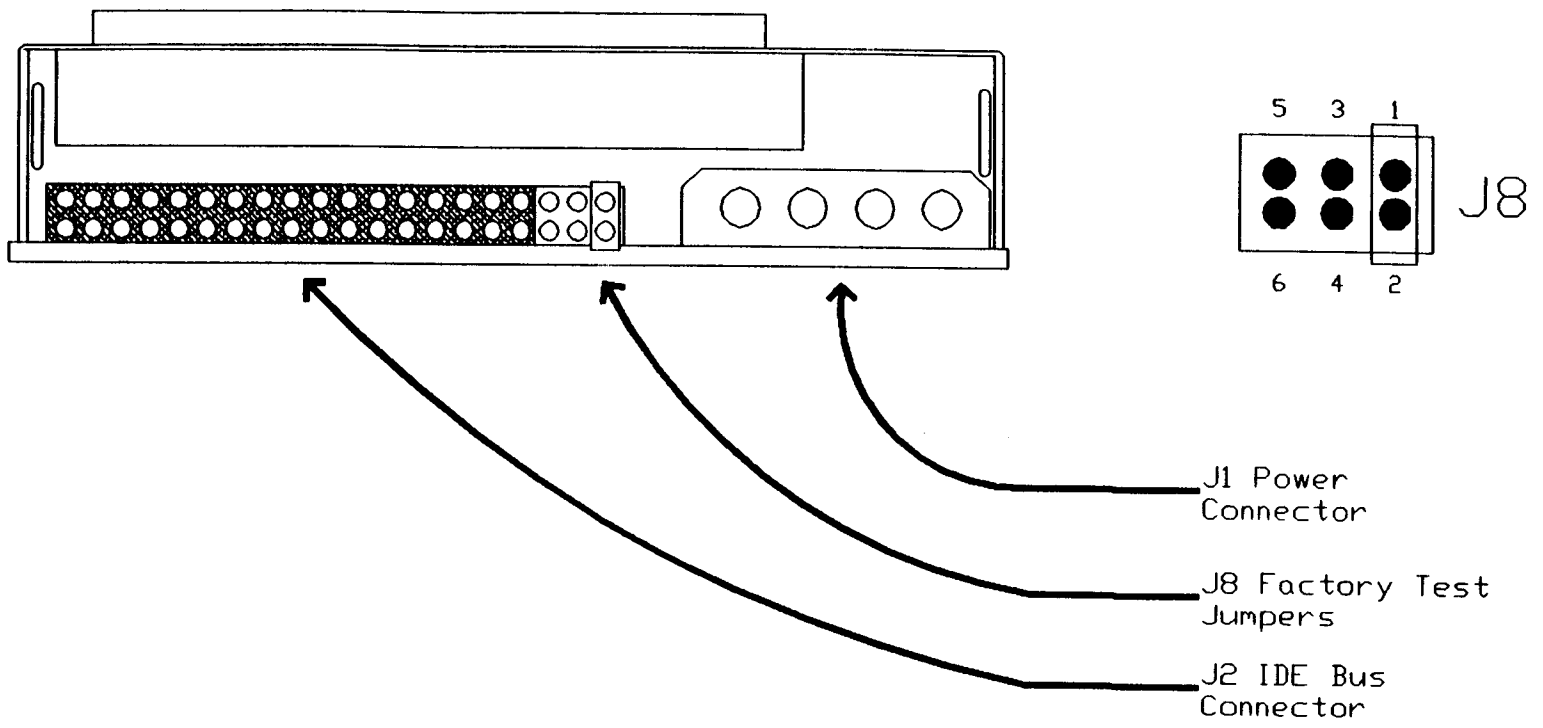

Figure 233. 20 MEG IDE Western Digital 93028 Smart Drive
 40 MEG IDE Western Digital 93044 Smart Drive

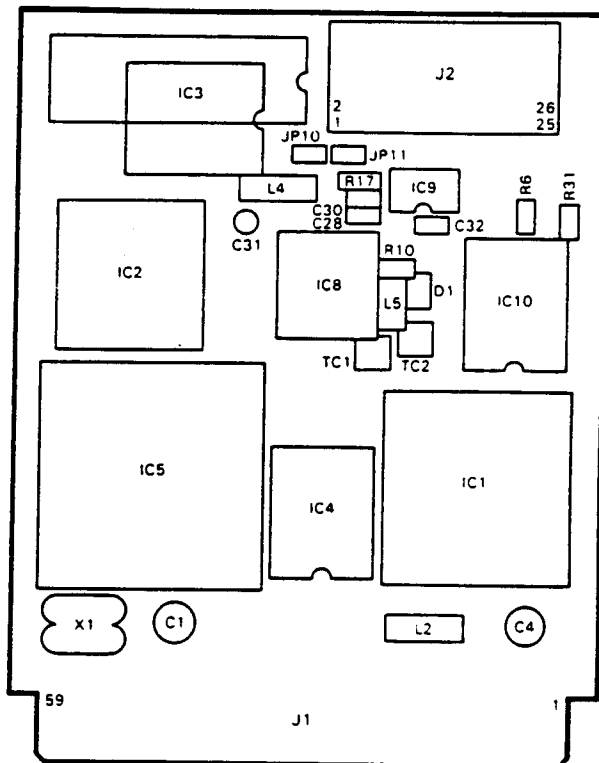
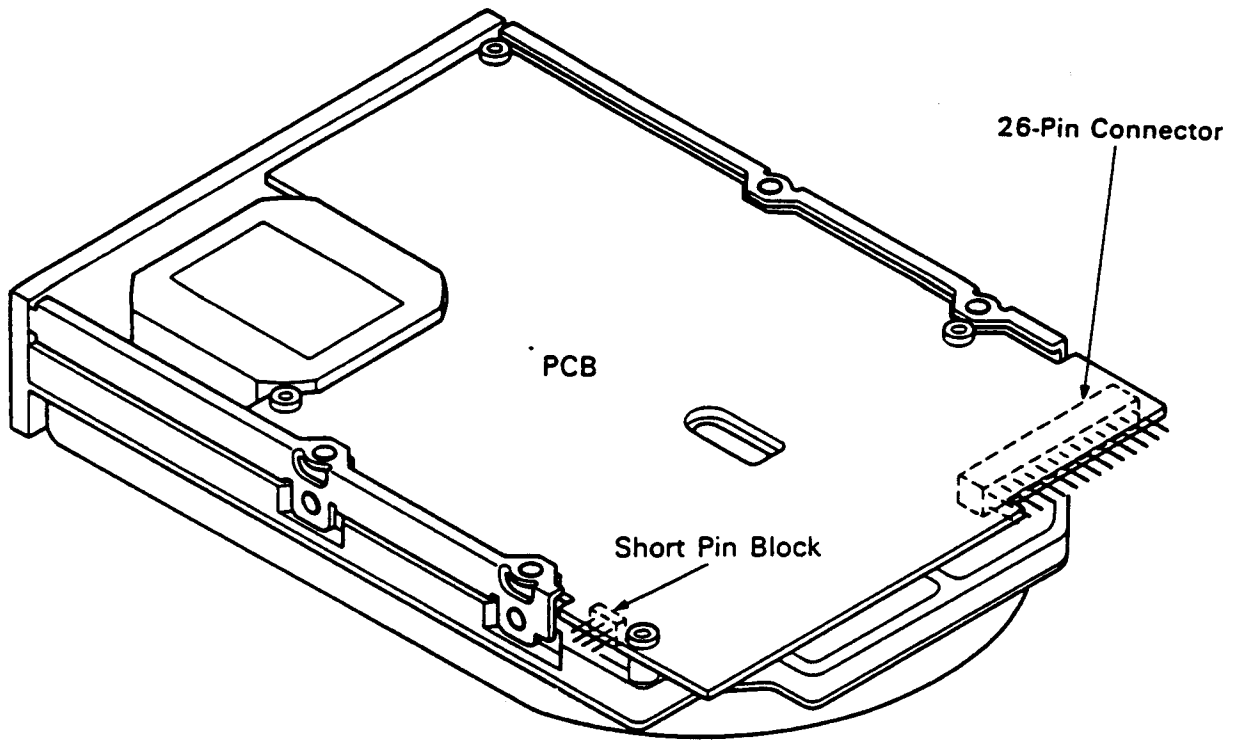

Figure 234. Hard Drive and Controller for Tandy 1400FD/HD

E9-E10-E11
See Text

E5-E6-E7
See Text

E2-E4-E8
See Text

E12-E13
See Text

E1-E3
See Text

E14-E15-E16
See Text

E17-E18-E19
See Text

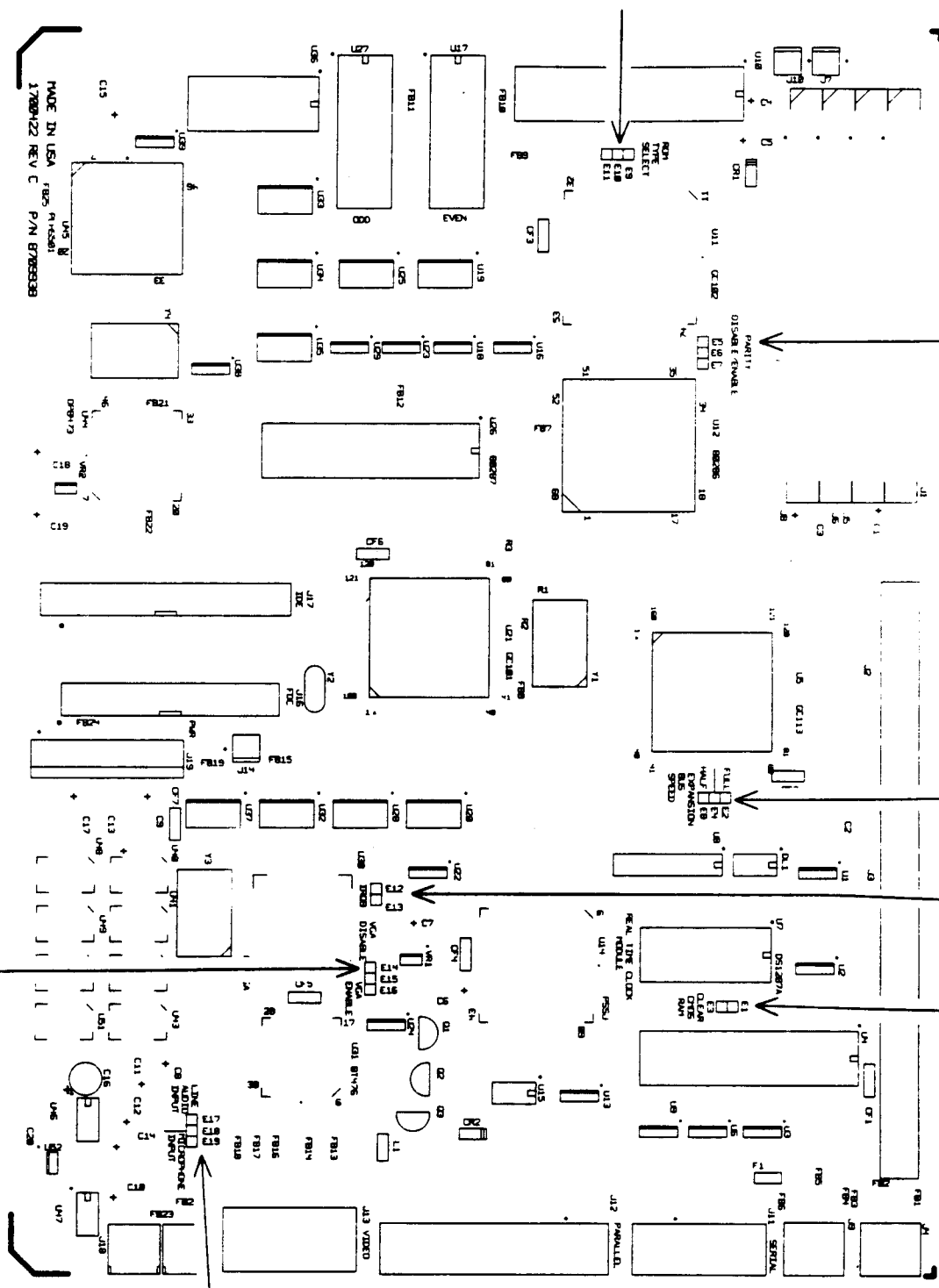

Figure 235. Tandy 2500XL Main Logic Board

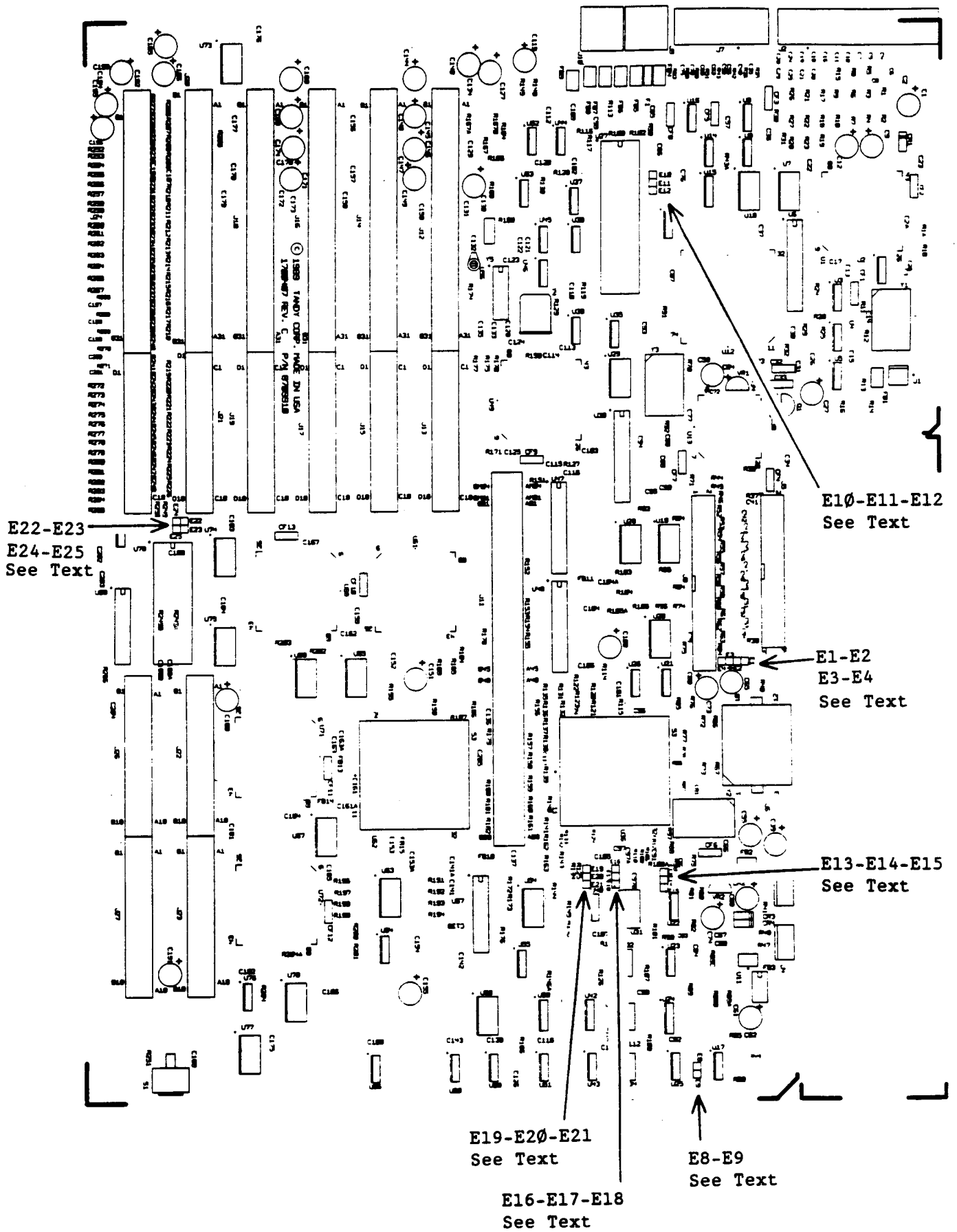

Figure 236. Tandy 4016DX/4020/25/33LX Main Logic Board

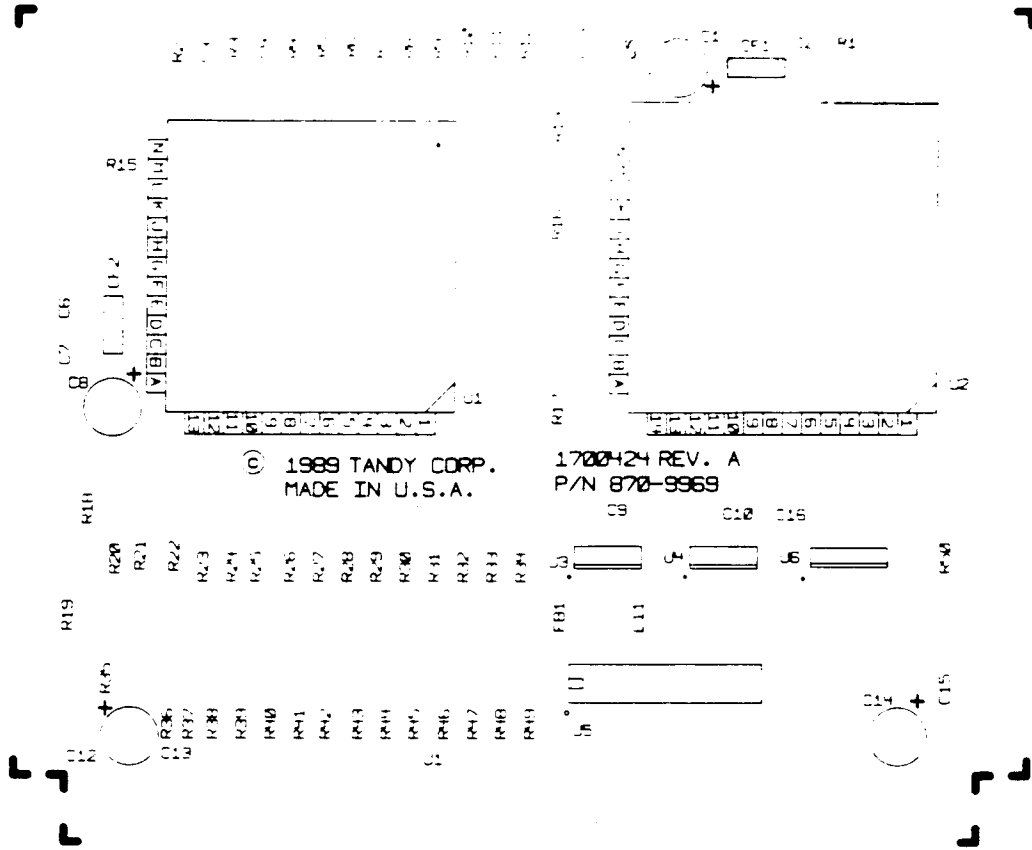

Figure 237. Tandy 4016DX CPU Board

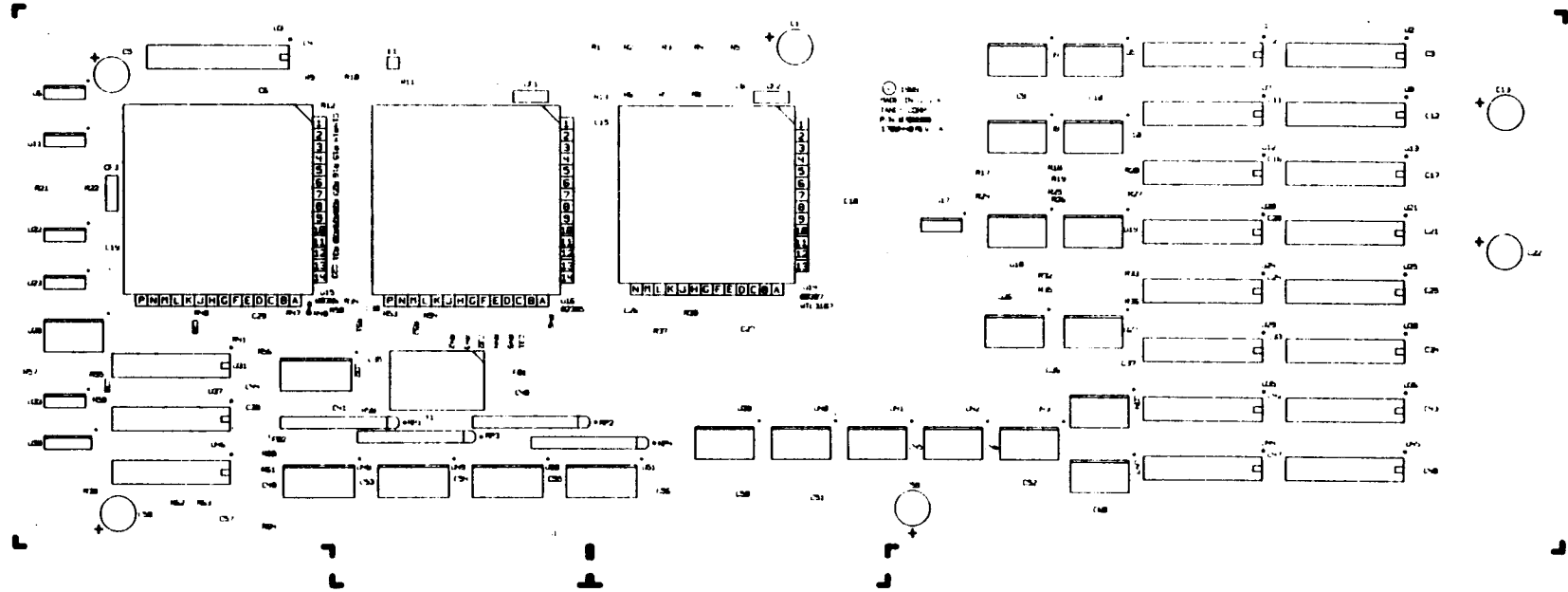

Figure 238. Tandy 4020LX CPU Board
 Tandy 4025LX CPU Board
 Tandy 4033LX CPU Board

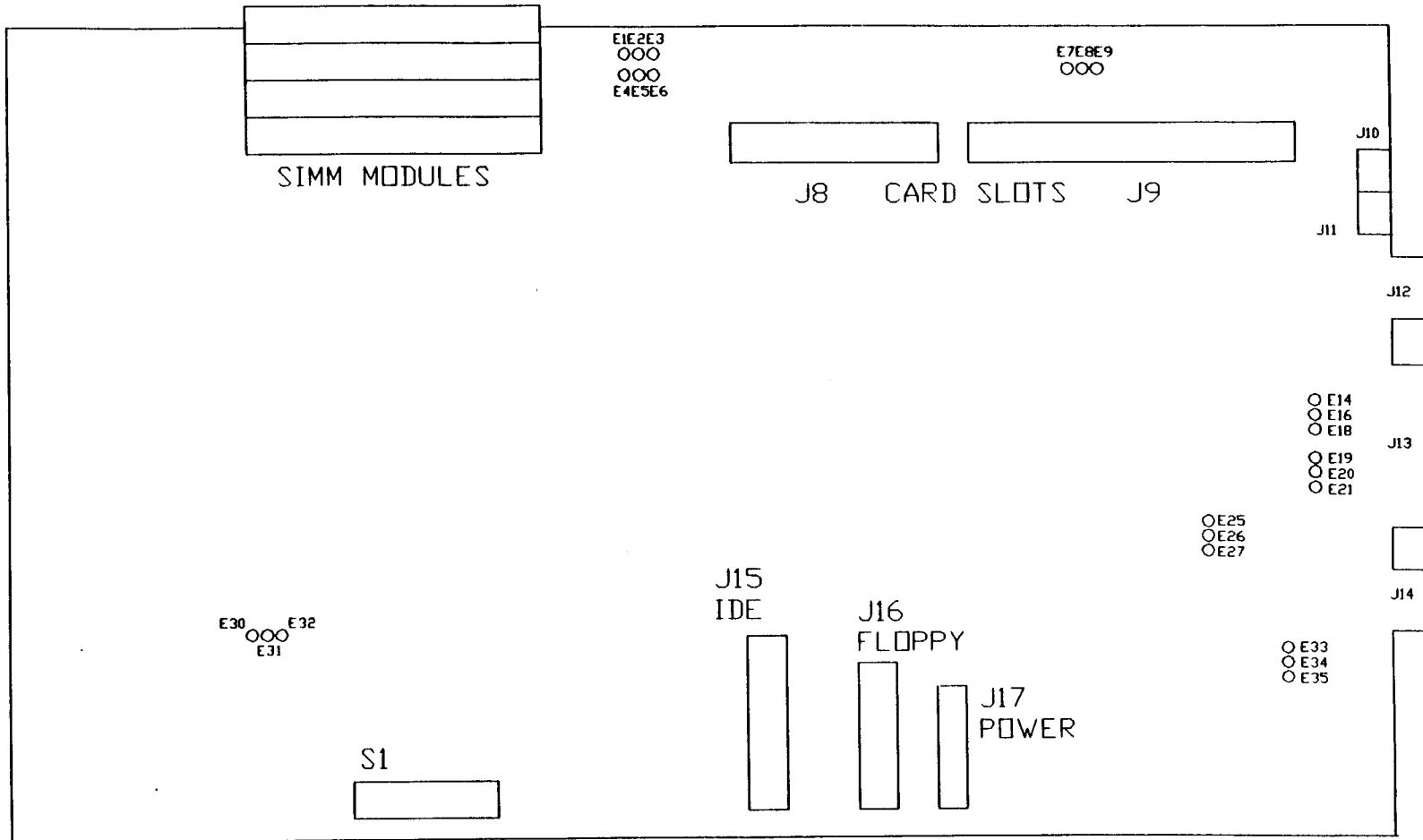

Figure 239. Main Logic Board for Tandy 4016SX

Bottom View

LED PCB



Thermistor PCB

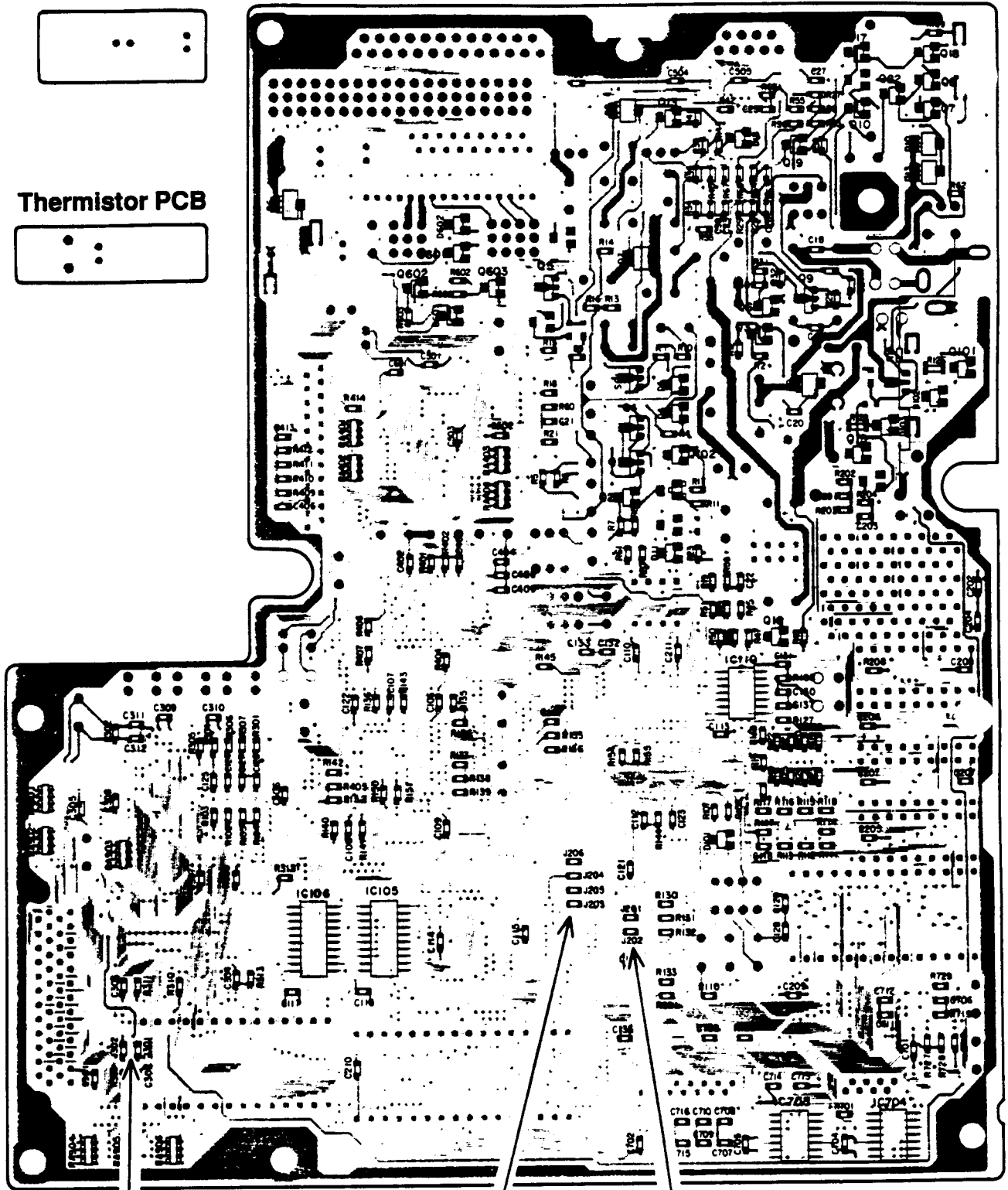

J301
J302
See Text

J203
J204
J205
J206
See Text

J201
J202
See Text

Figure 240. Tandy 1100FD Main Logic Board - Solder Side

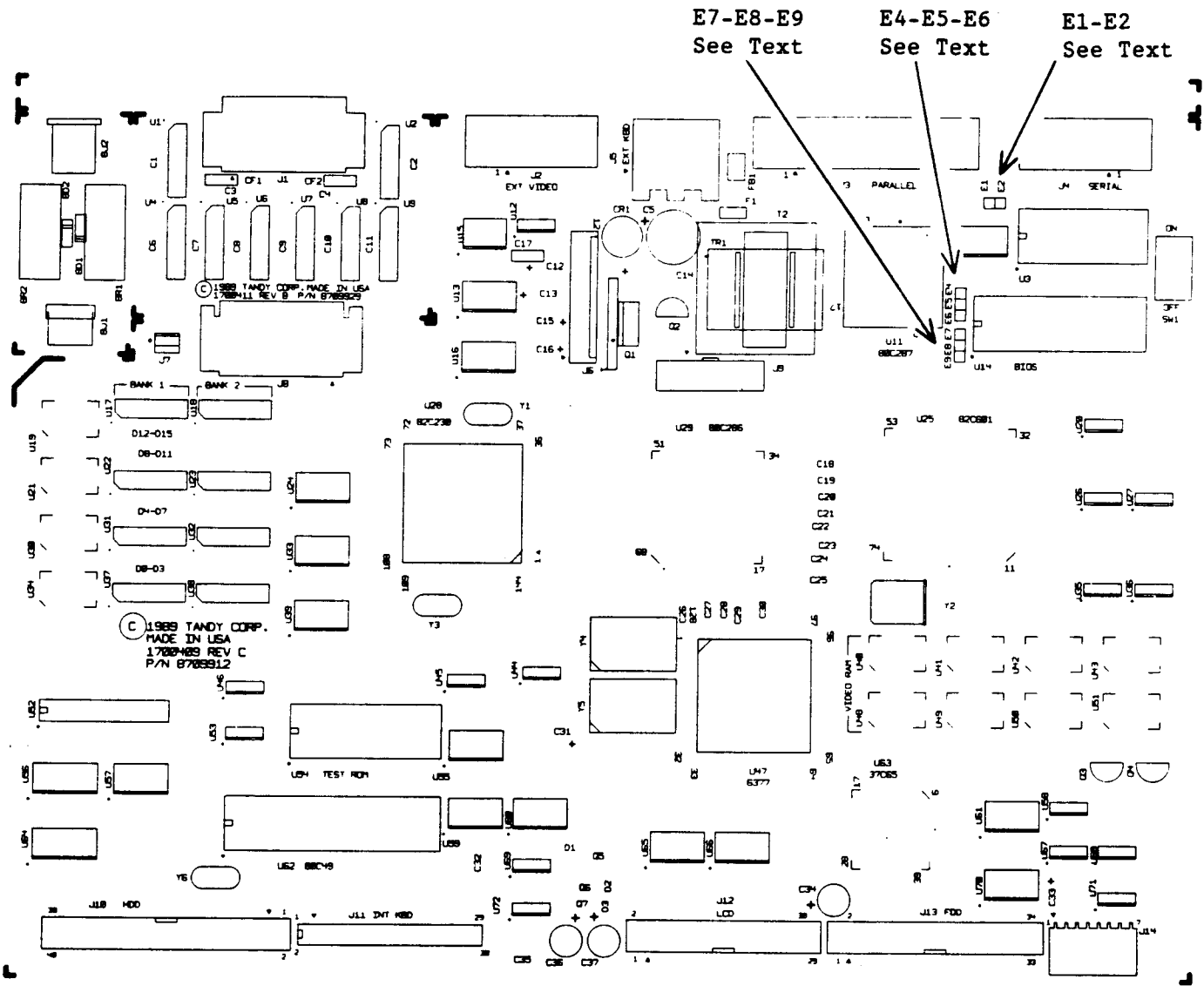

E7-E8-E9
See Text

E4-E5-E6
See Text

E1-E2
See Text

SW1
See Text

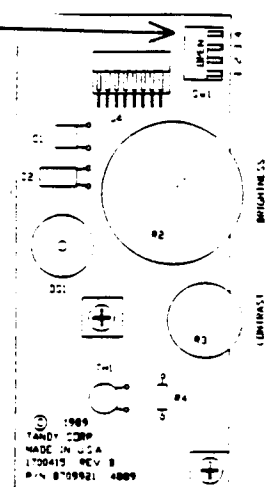

Figure 241. Tandy 2800HD Main Logic Board
Brightness/Contrast/Switch Board

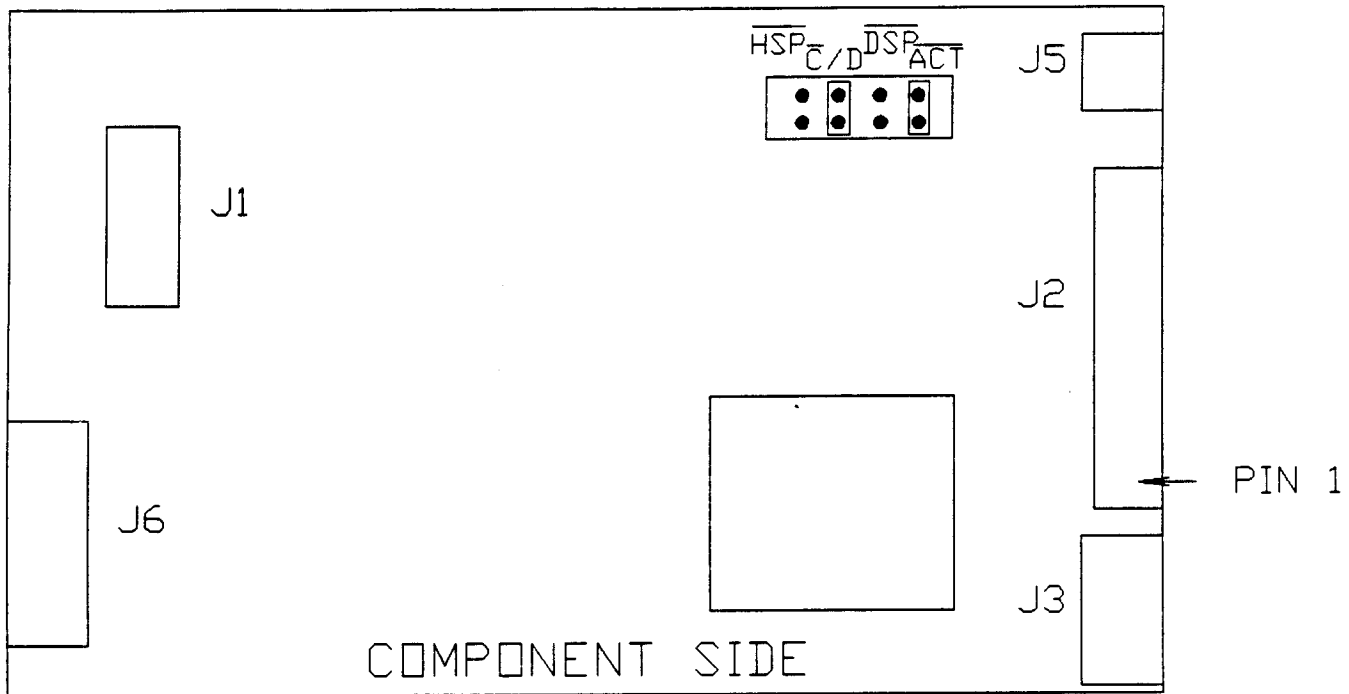
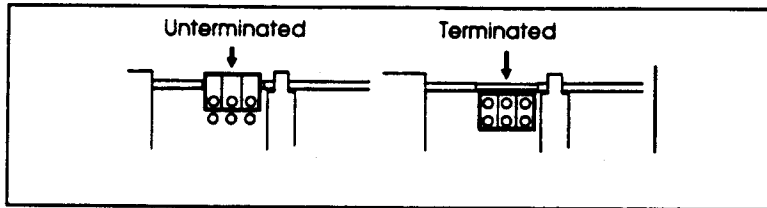
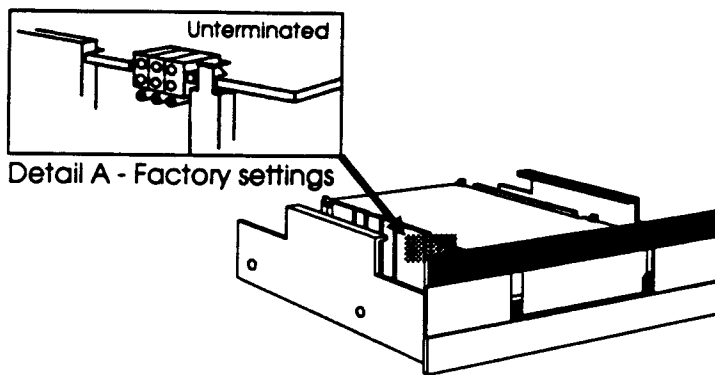
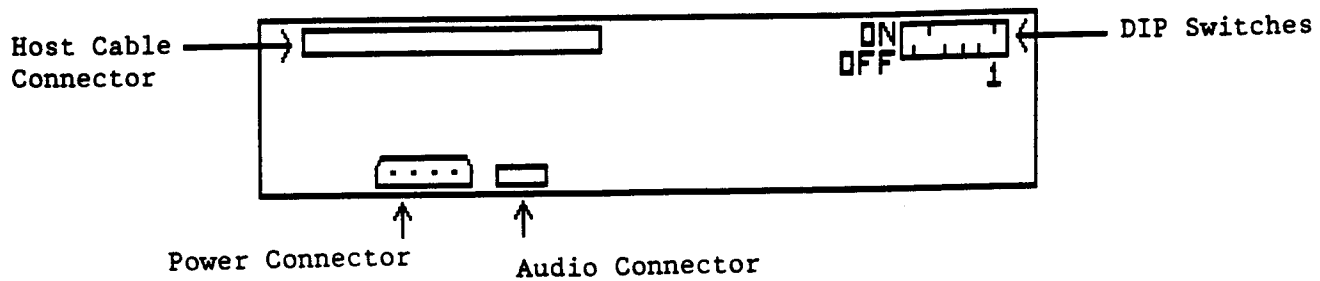

Figure 242. Conner CP-3044 40 MEG 1" Hard Drive
 Conner CP-3024 20 MEG 1" Hard Drive



Detail B - Side view of tape drive showing jumper settings

Figure 243. 60 MEG 5 1/4" Internal Tape Drive



CD-ROM Drive Mechanism

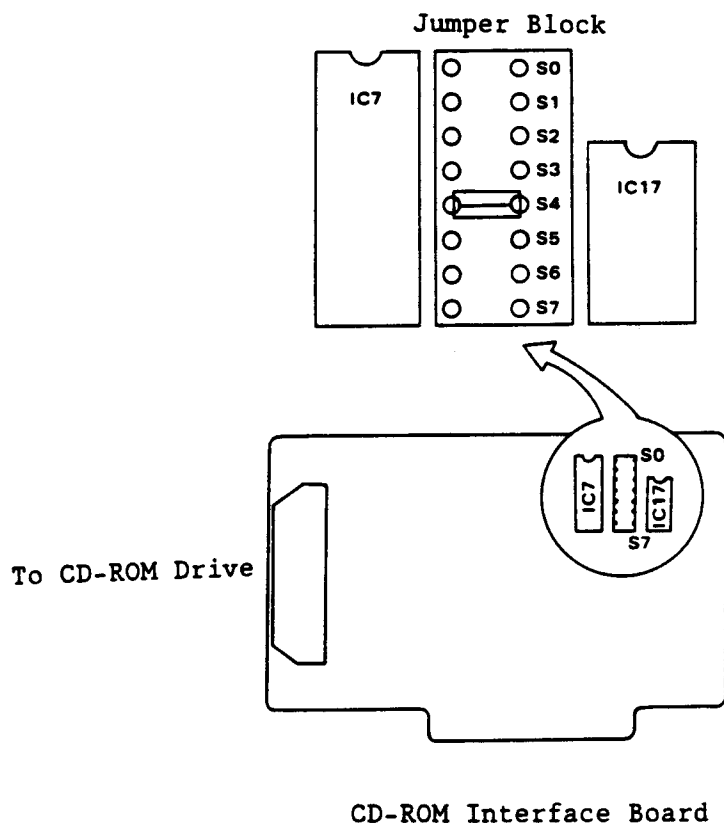

Figure 244. Hitachi CD ROM player and Interface

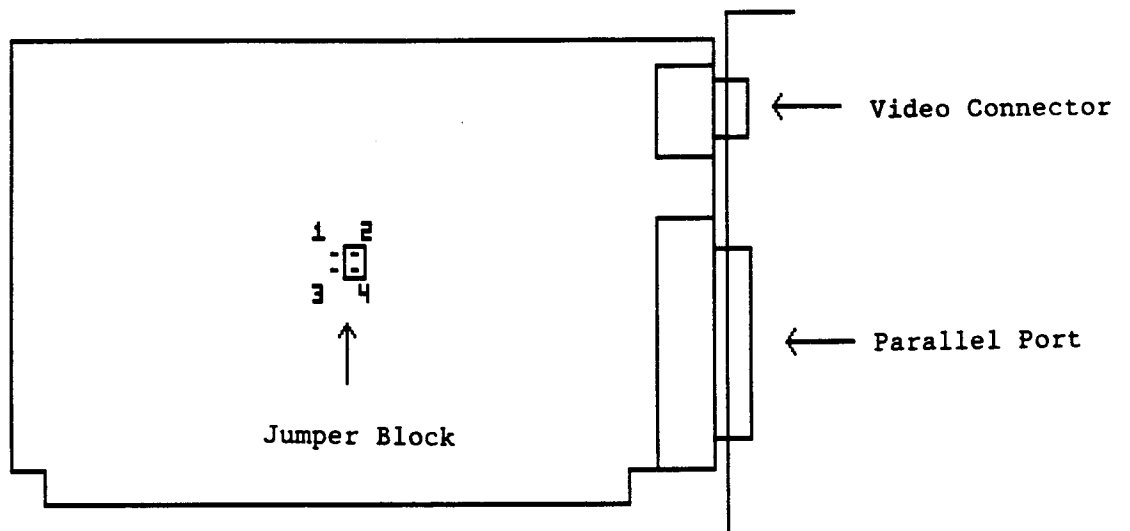

Figure 245. Monochrome/parallel Adapter Board

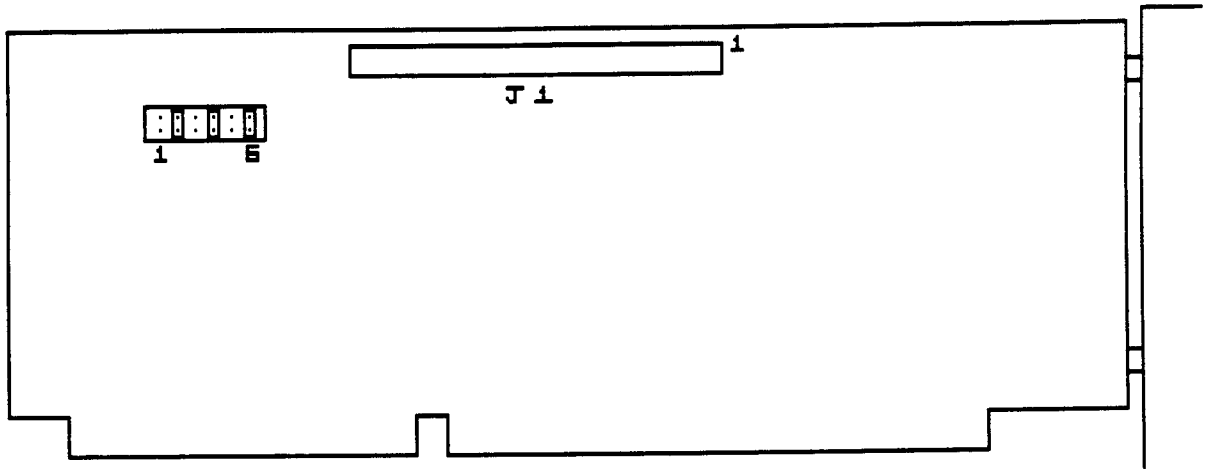

Figure 246. Smart Drive Interface Adapter Board

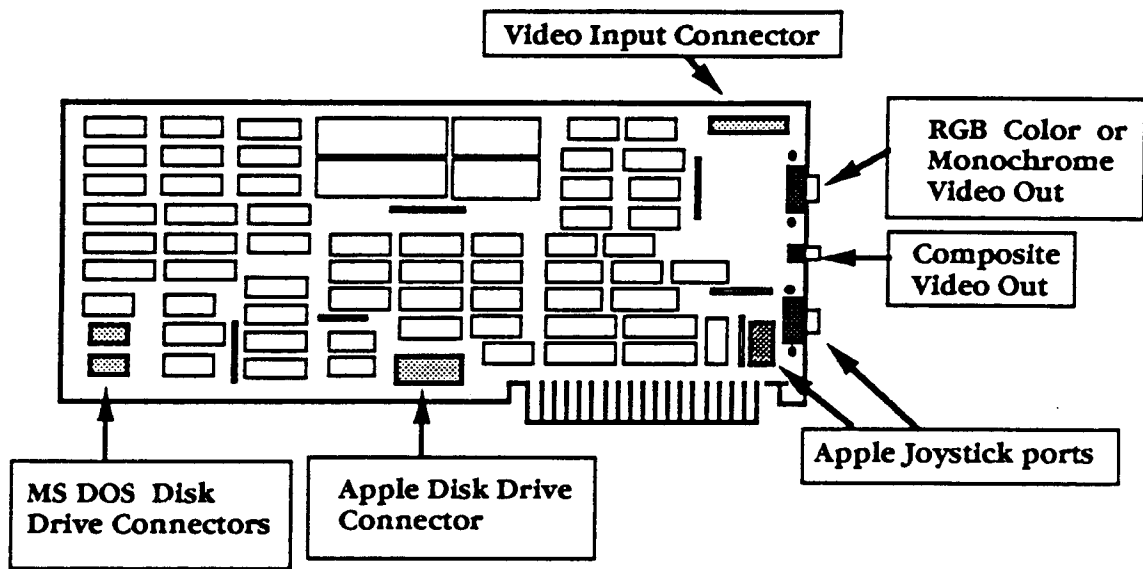

Figure 247. Trackstar 128 Interface Board
Trackstar E Interface Board

W9 - Boot ROM Size
16 KBytes - 27128 Type

W1 - Clear Configuration
Not Enabled

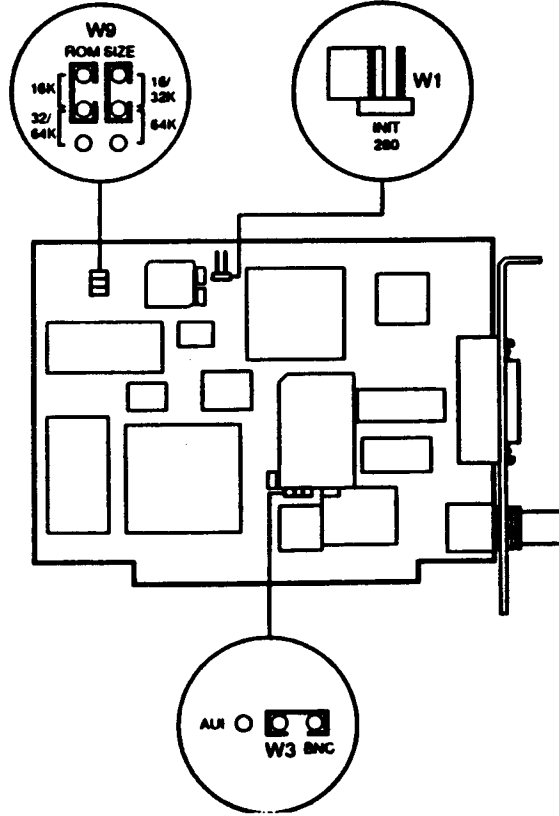

Figure 248. Tandy Ethernet Adapter Board

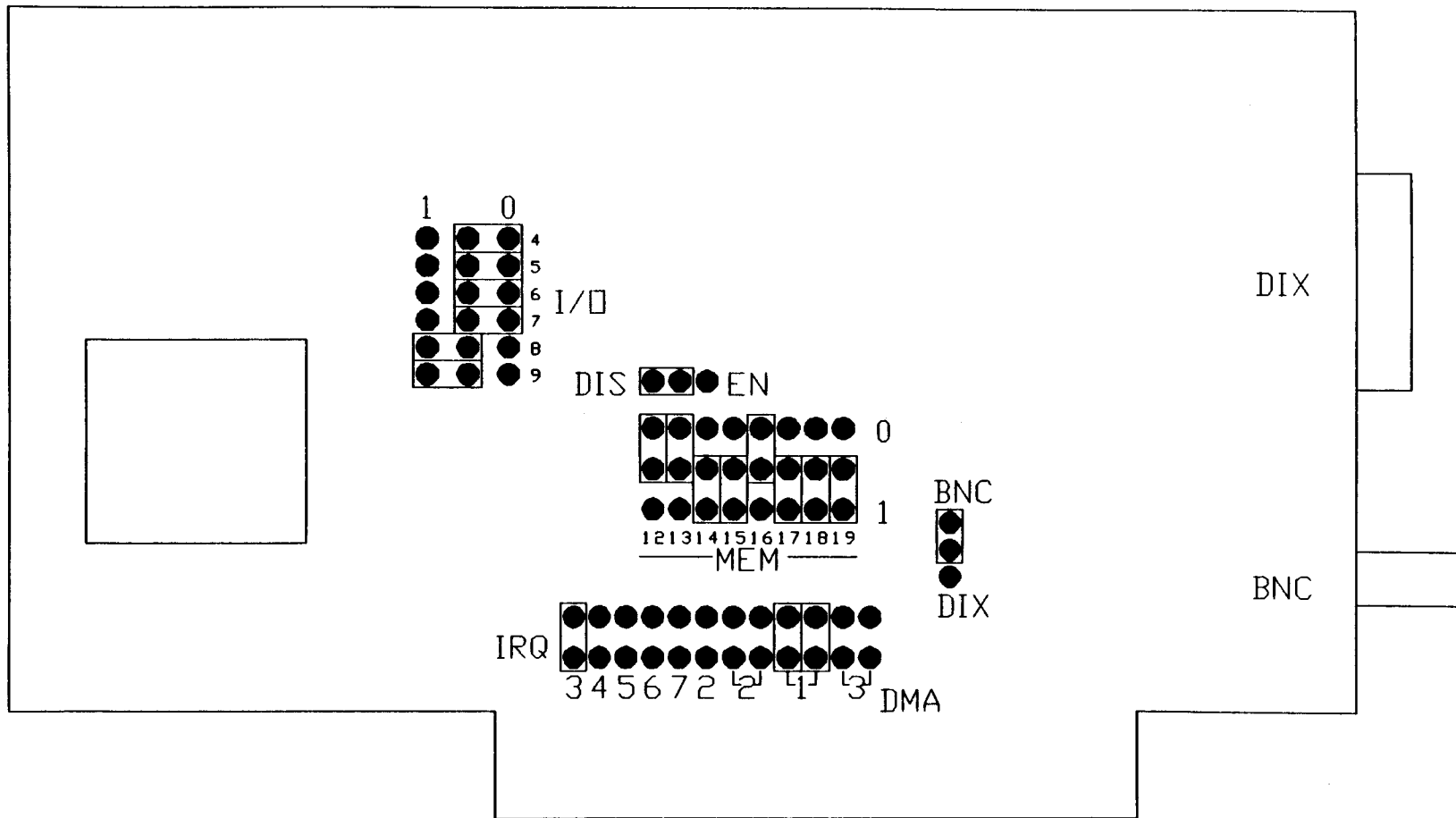

Figure 249. Late Style Etherlink I Adapter Board

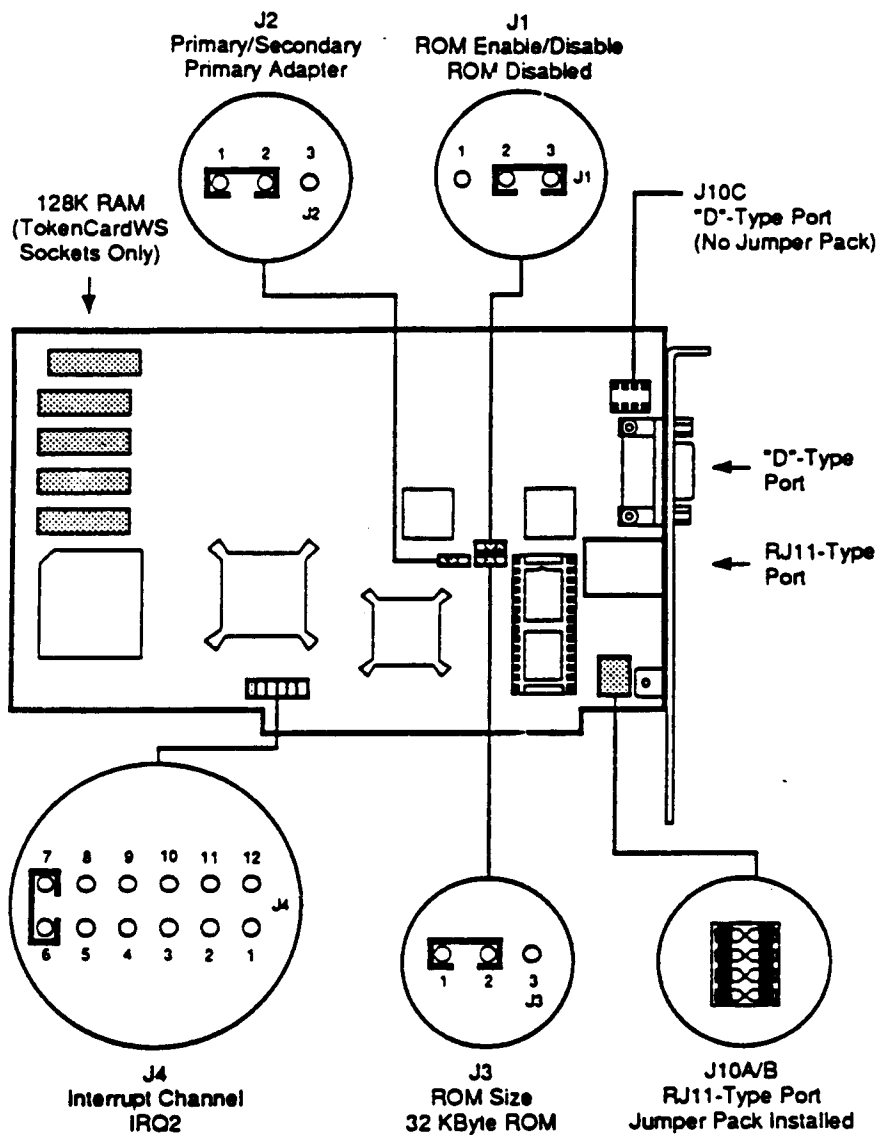
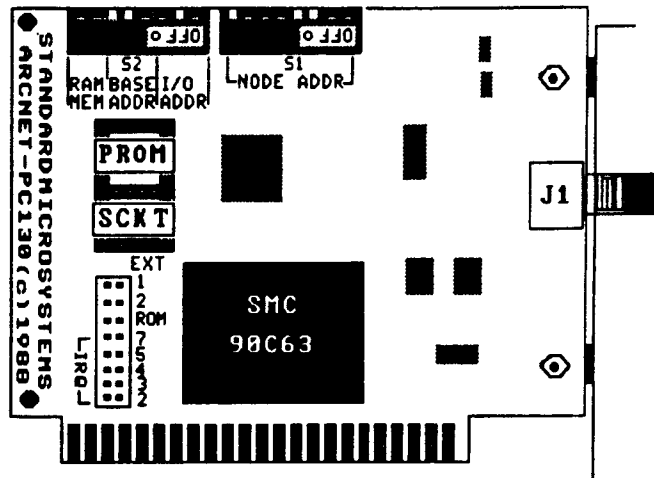

Figure 250. Tandy Token Ring Adapter Board



Legend:

- SMC 90C63 ARCNET Controller / Transceiver / Support Logic
- S1 1-8: Node ID Select
- S2 1-3: I/O Base Address Select
- 4-6: Memory Base Address Select
- 7-8: RAM Offset Select
- EXT Extended Timeout Select
- IRQ Interrupt Select
- ROM ROM Enable Select
- J1 BNC RG-62/U Connector

Figure 251. Tandy Arcnet Adapter Board

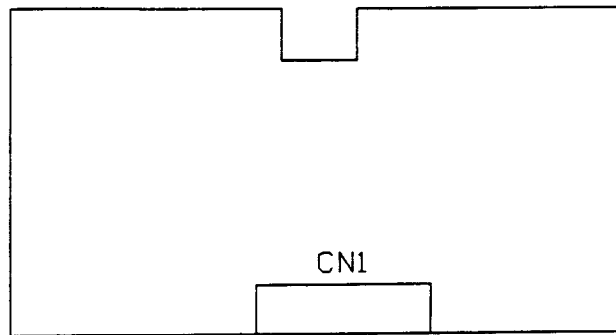

UPPER PCB
ASSEMBLY

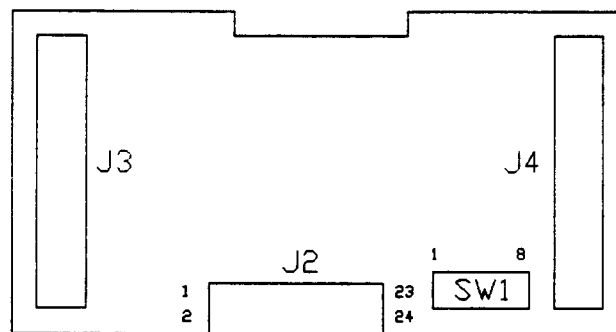

LOWER PCB
ASSEMBLY

Figure 252. Serial Parallel Converter

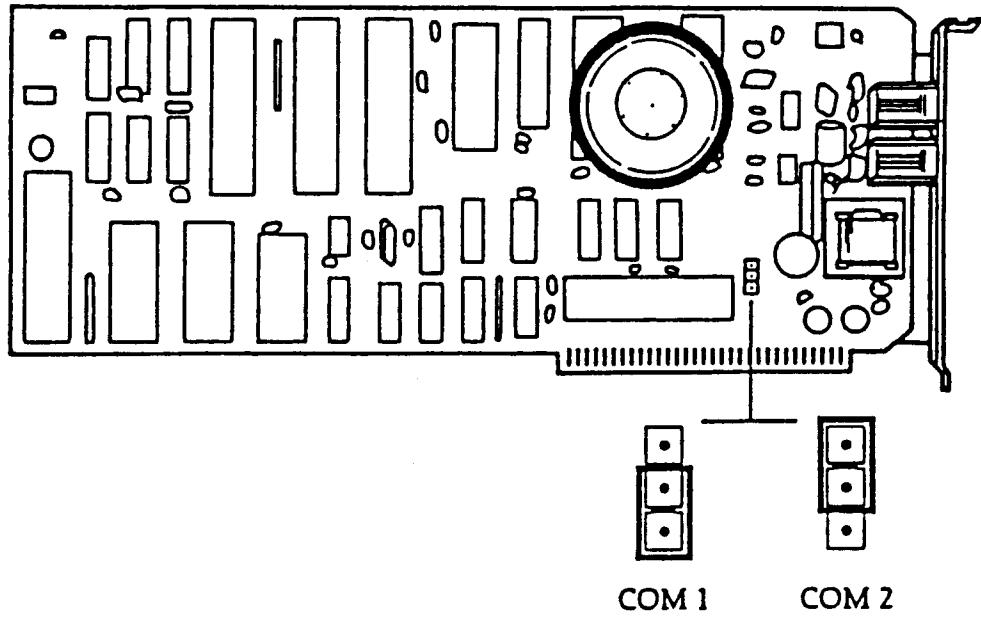

Figure 253. Tandy 2400 Baud Error Correcting Modem Board

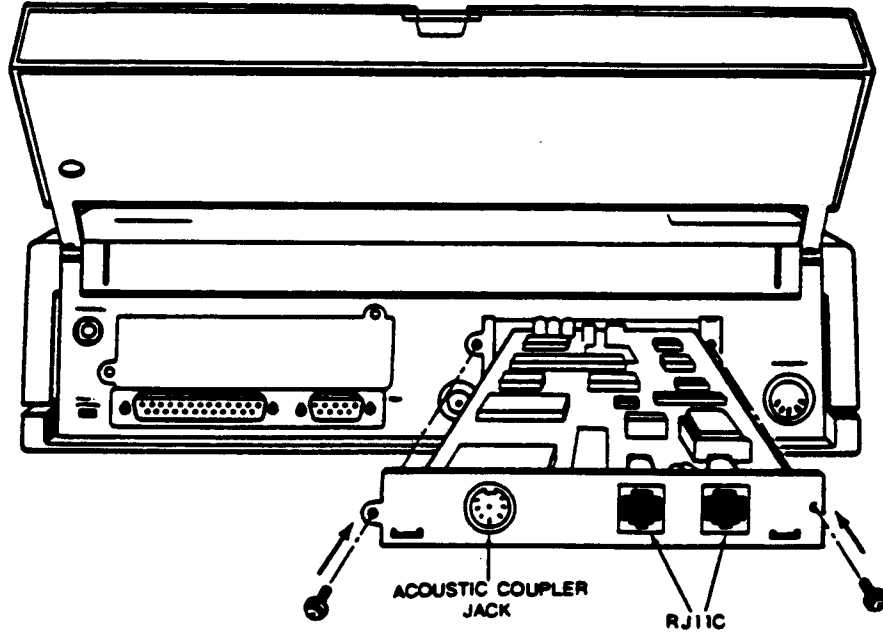

Figure 254. Tandy 1400LT/FD/HD 2400 Baud Internal Modem Board

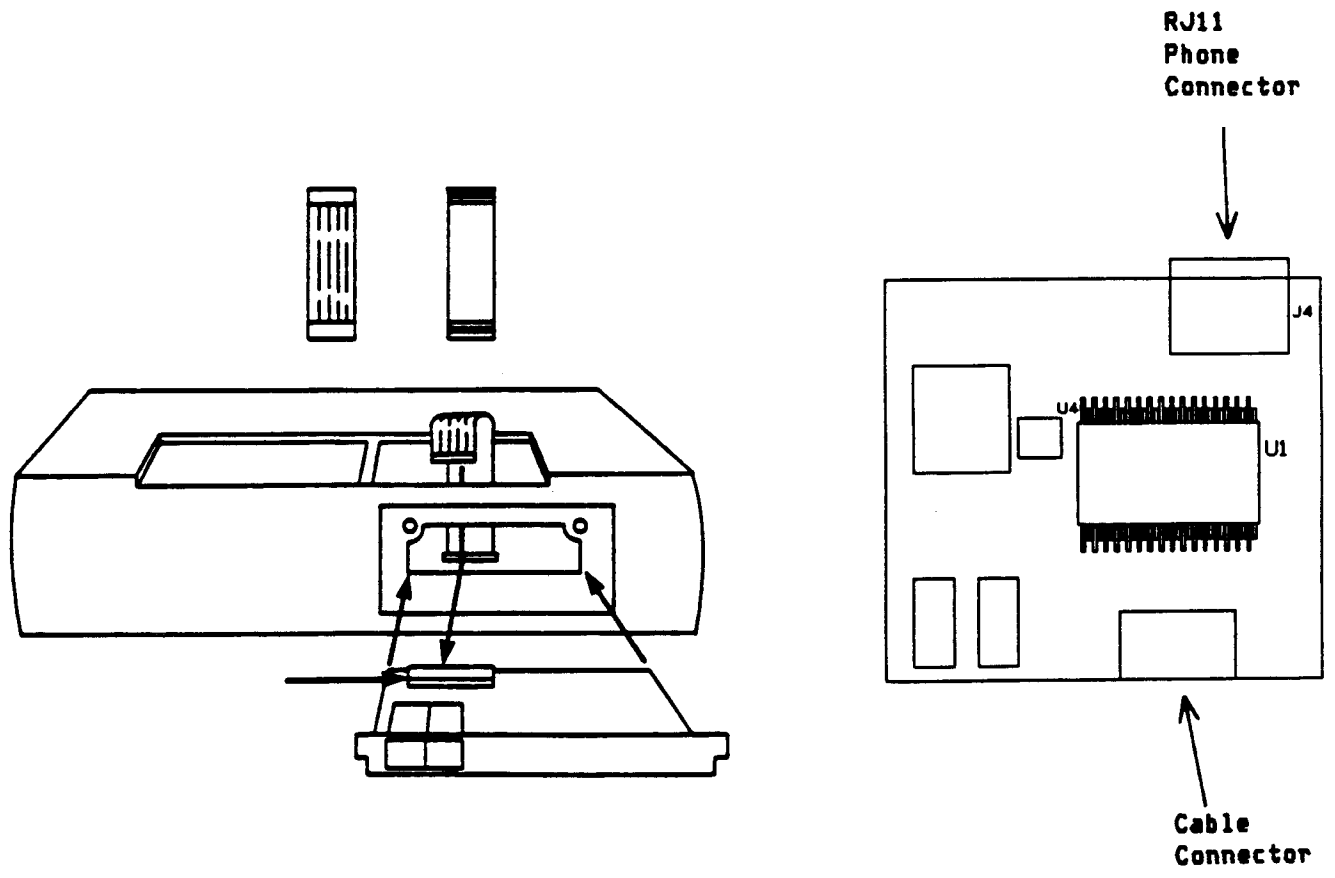

Figure 255. Tandy 1100FD Internal Modem Board

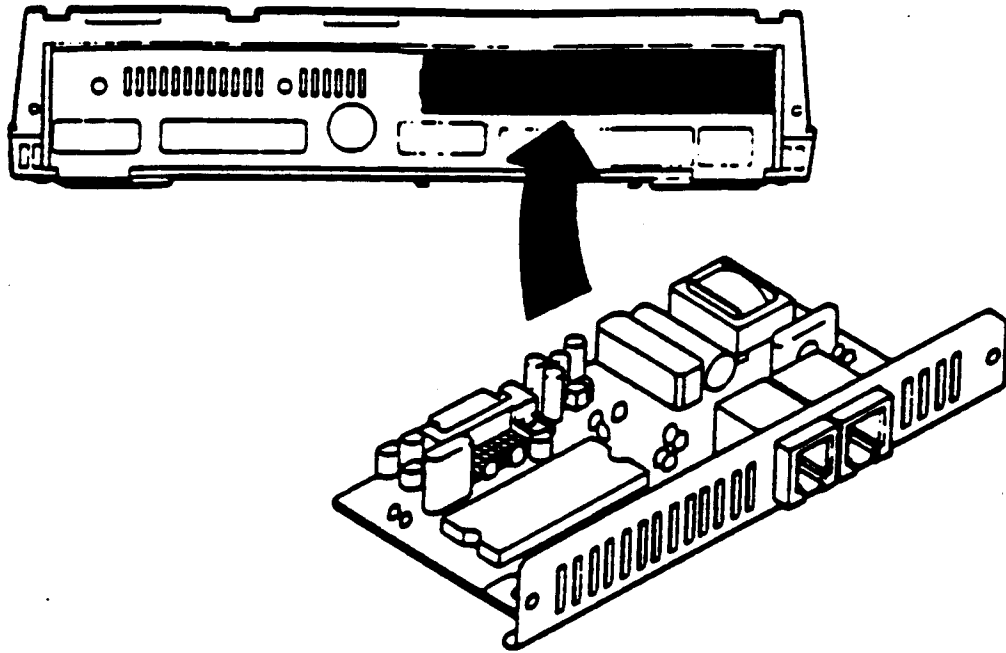

Figure 256. 2400 Baud Internal Modem for Tandy 2800HD

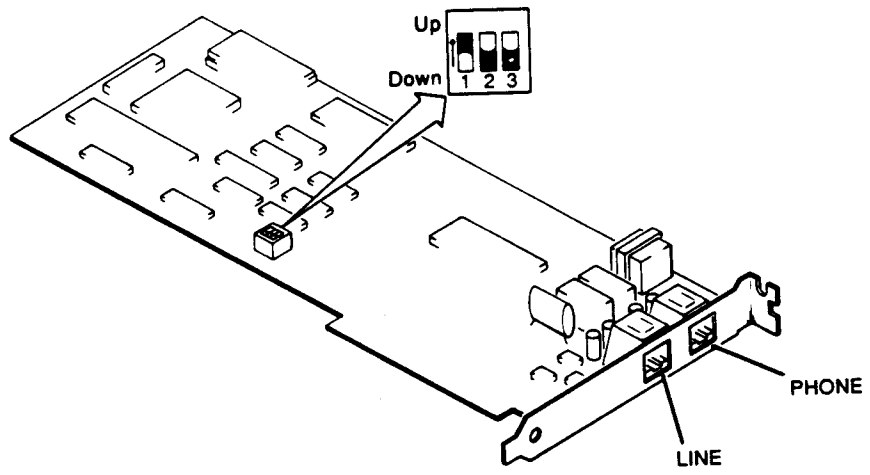

Figure 257. Tandy Faxmate Board

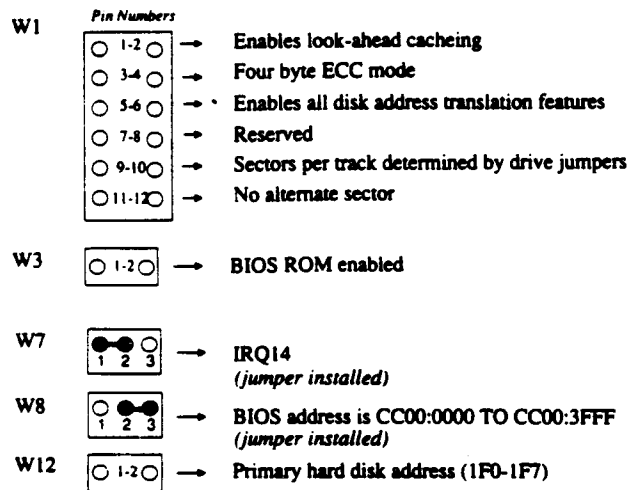
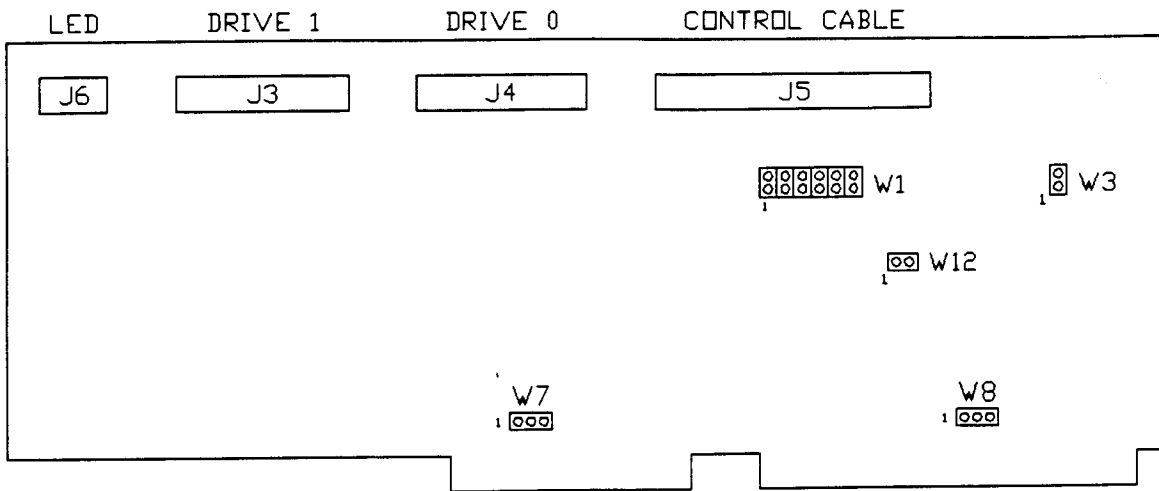

Figure 258. Western Digital ESDI Controller for AT style computers

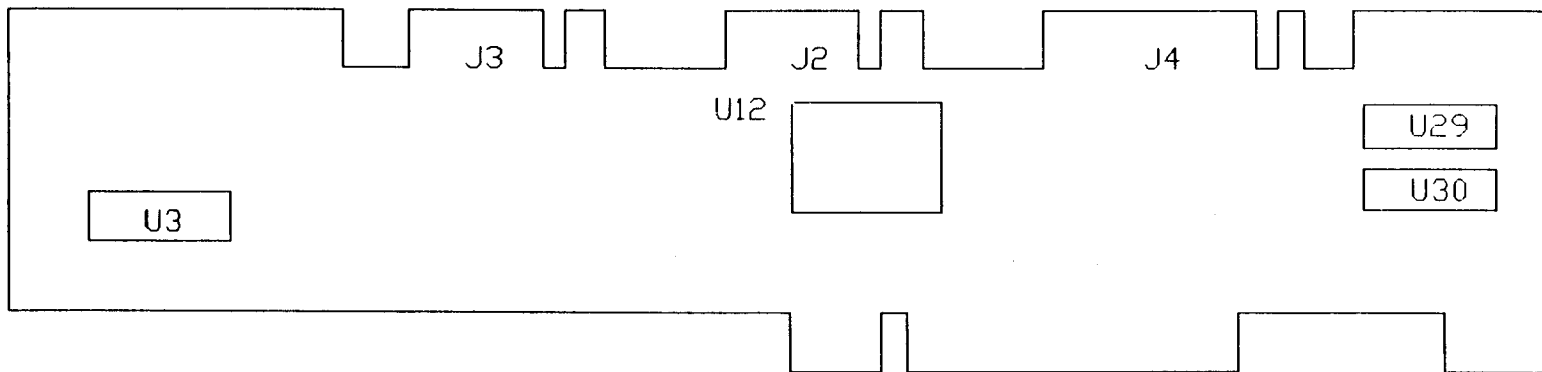

Figure 259. Western Digital ESDI Controller for Tandy 5000MC

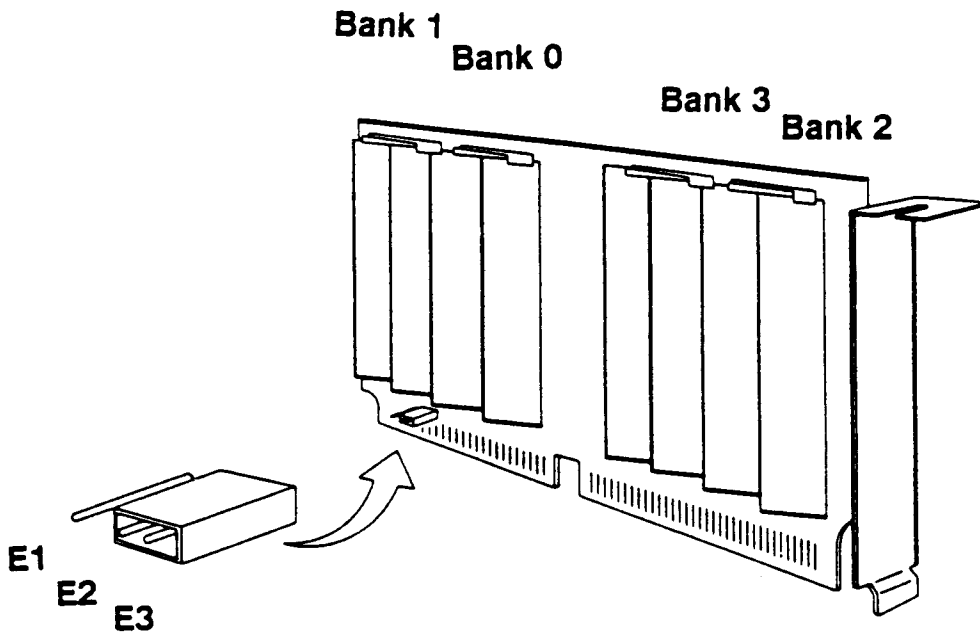

Figure 260. Memory Adapter Board for Tandy 4000SX

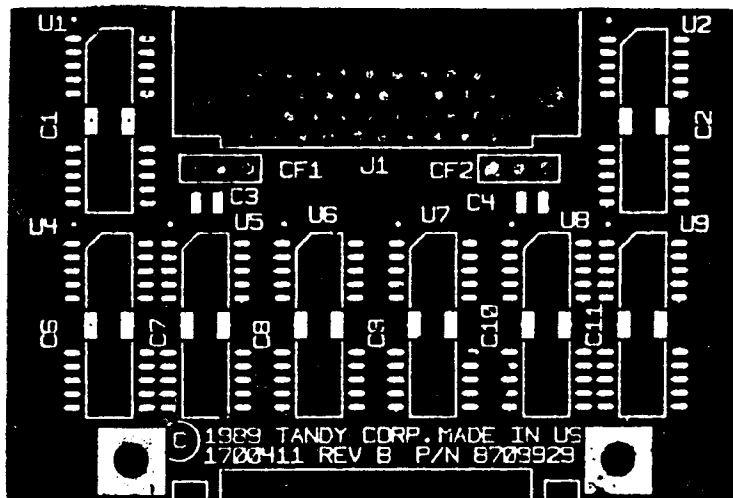

Figure 261. 1 MEG Memory Upgrade Board For 2800HD

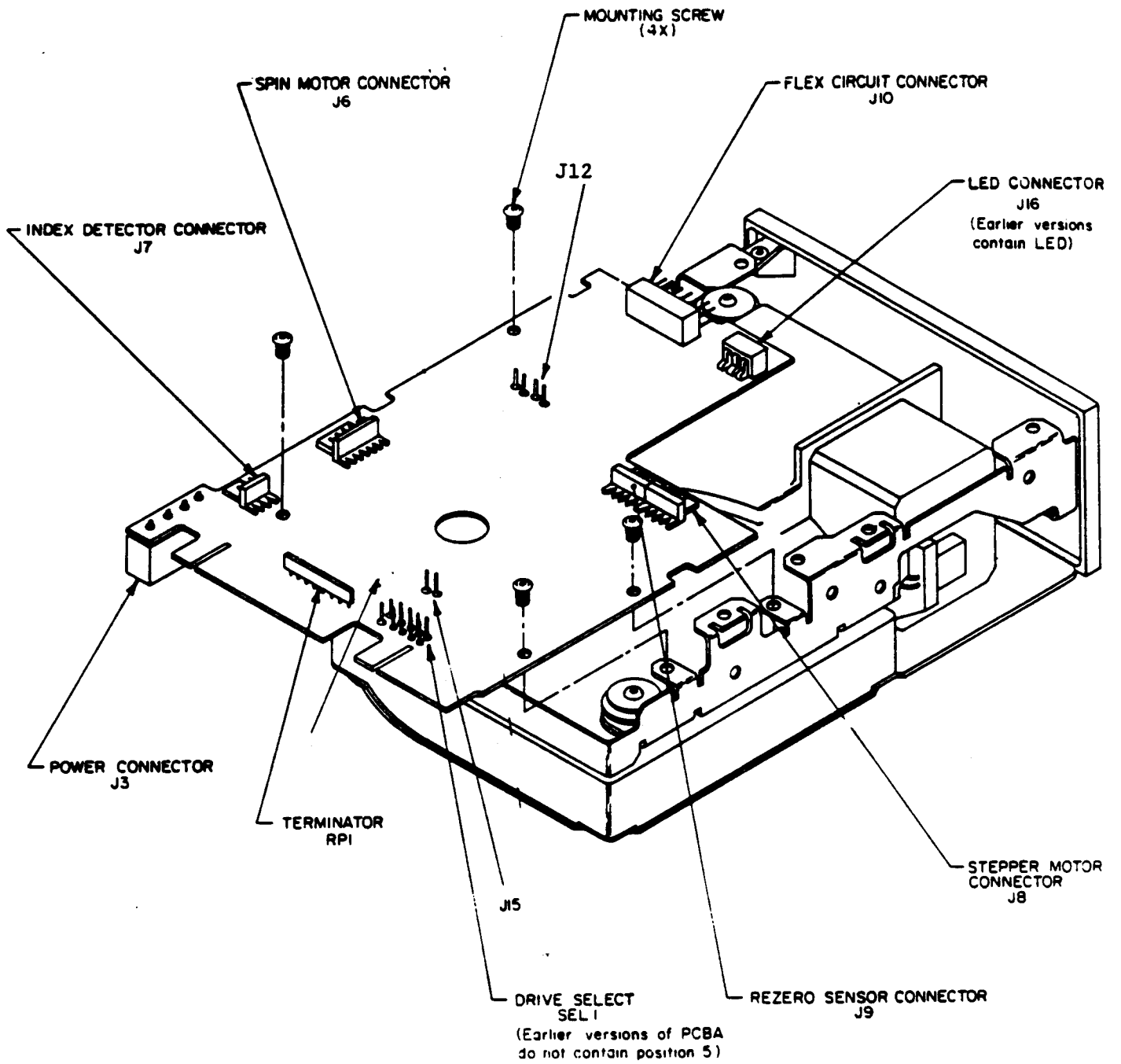
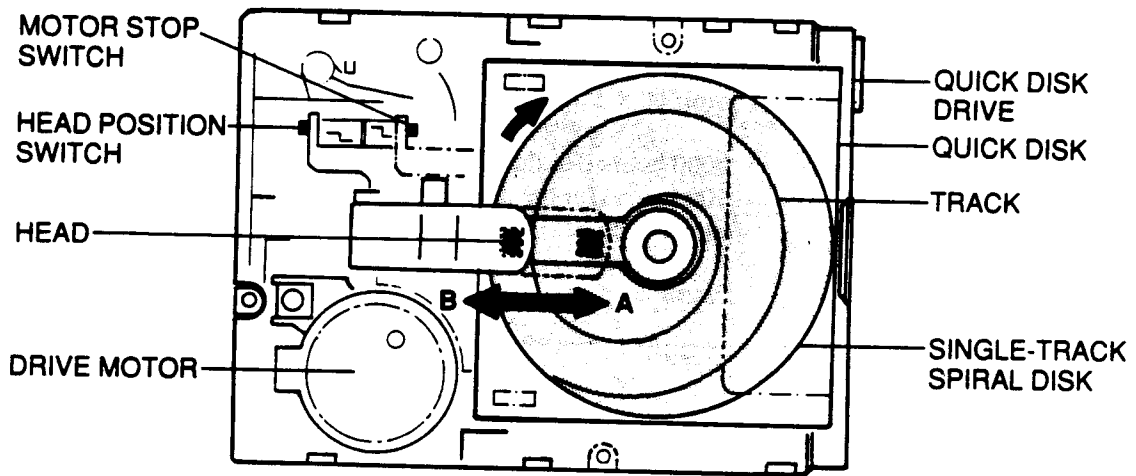
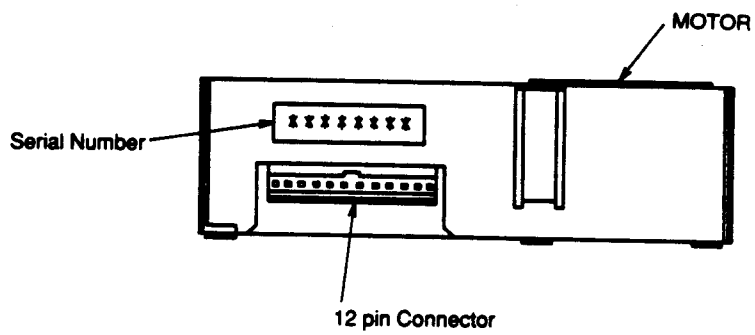

Figure 262. 20 MEG MiniScribe 8438 Hard Card
 Version 3



TOP VIEW



Back Side View

Figure 263. 2.8" Quick Disk Drive for WP100

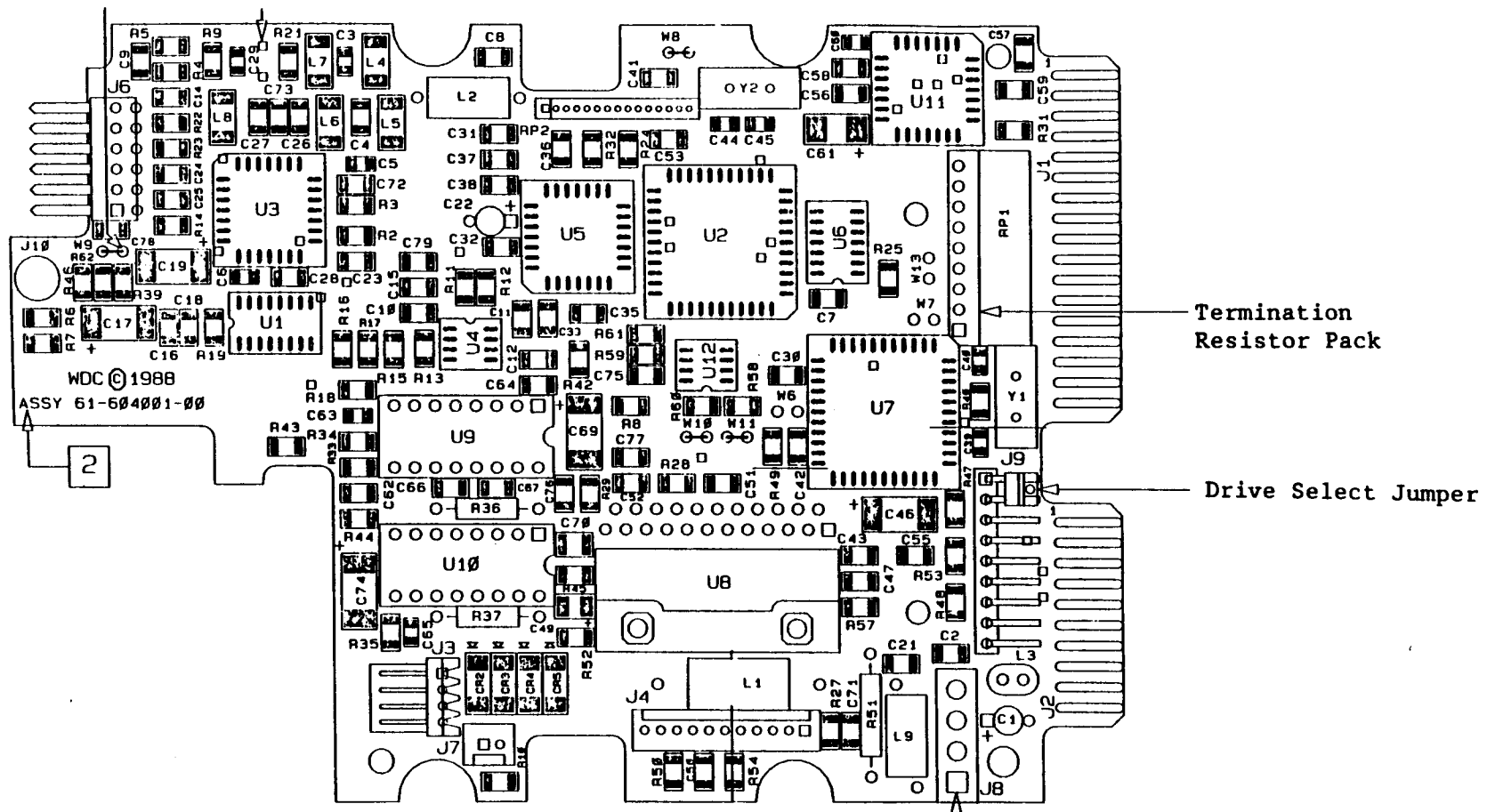

Figure 264. Western Digital WD344 40 Meg Hard Card Hard Drive Logic Board
 Note: Component side shown. On the bubble it will be facing down with the solder side facing up.

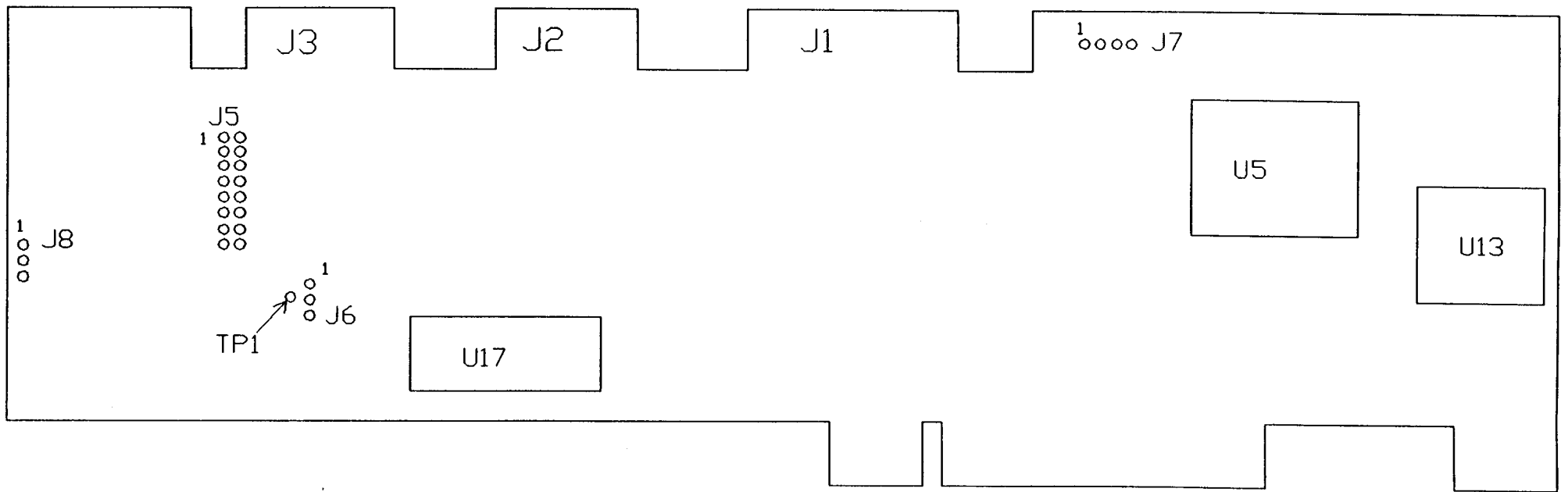

Figure 265. Adaptec ST506 Hard Drive Controller For Tandy 5000MC

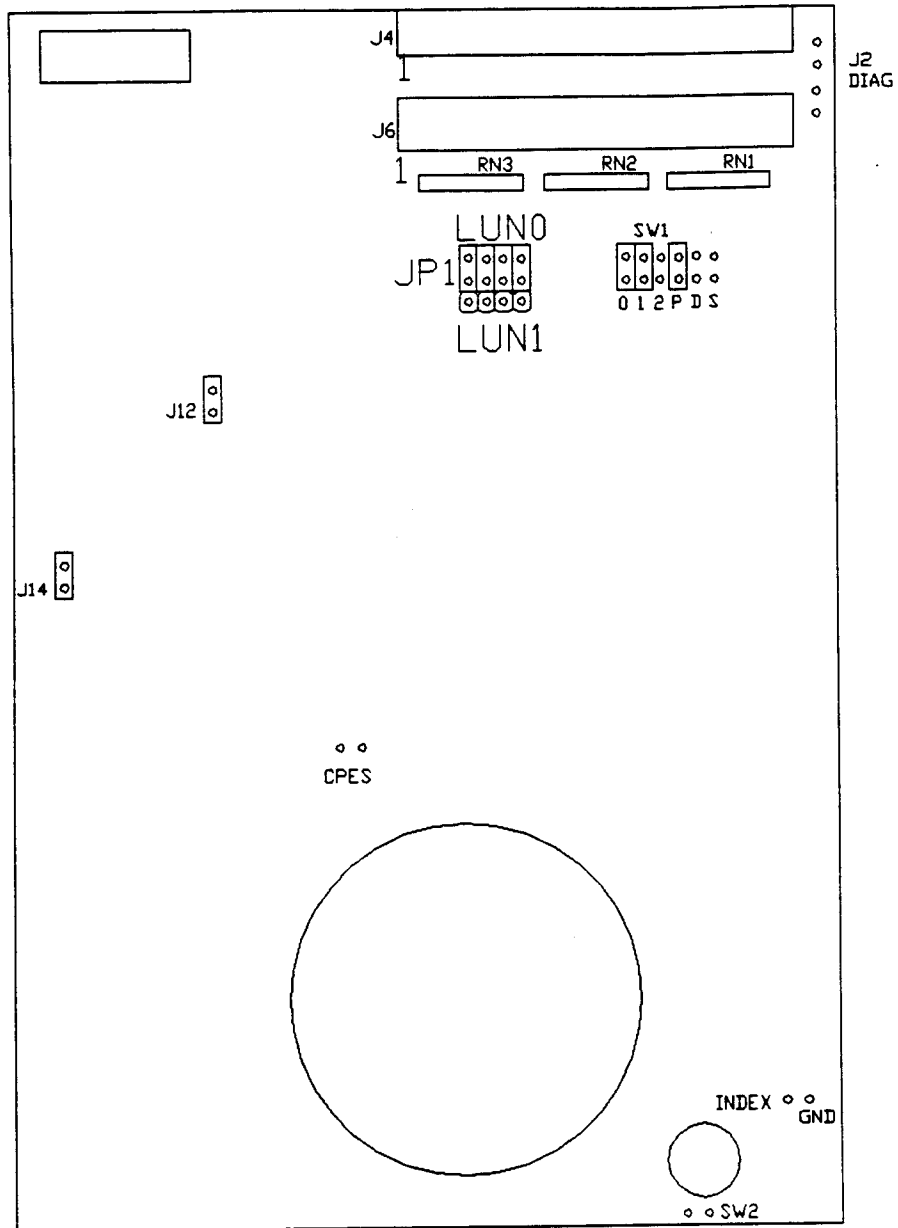

Figure 266. 20 MEG Internal DCS "A" Version - BETA L

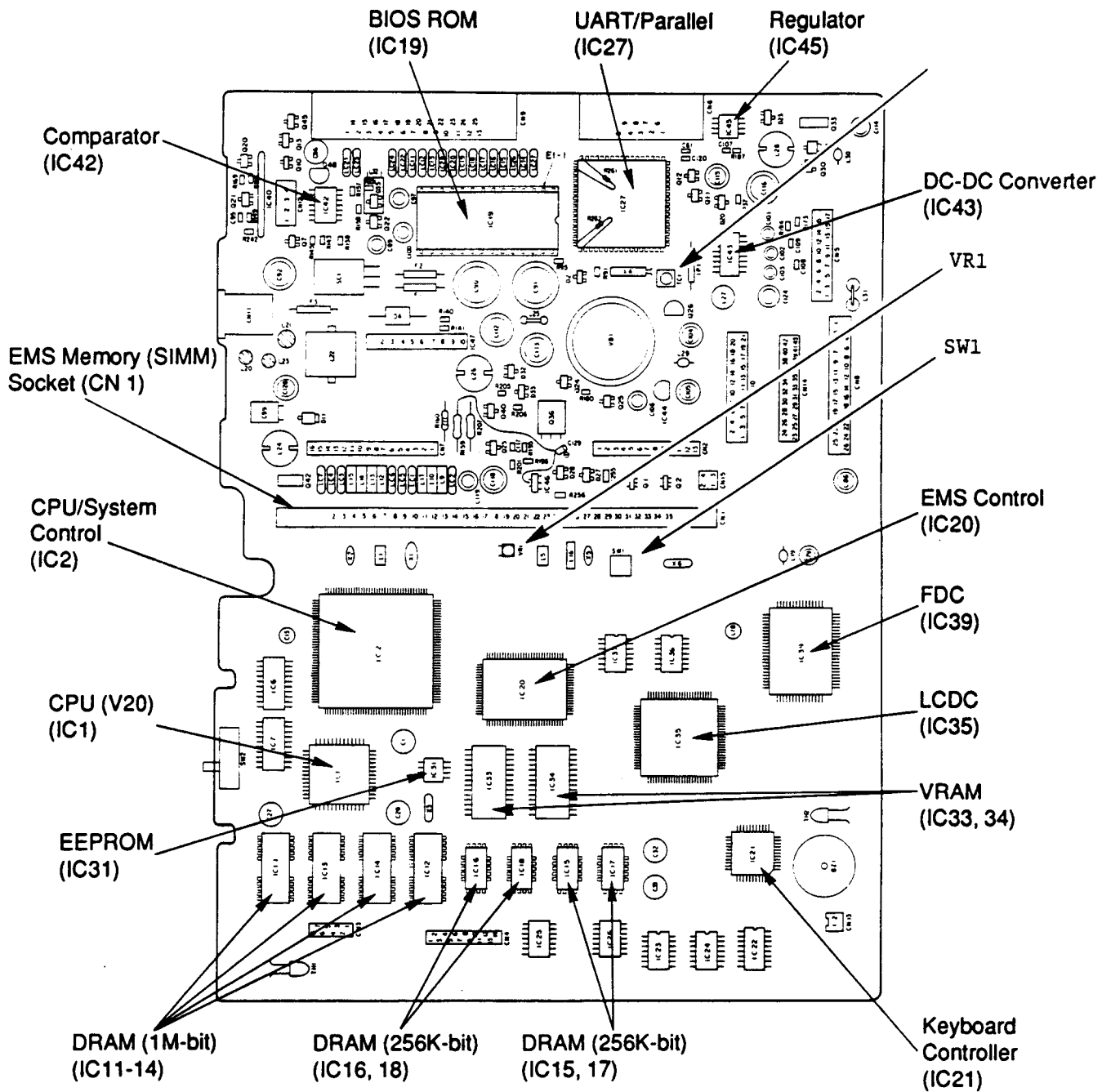

Figure 267. Tandy 1500HD Main Logic Board

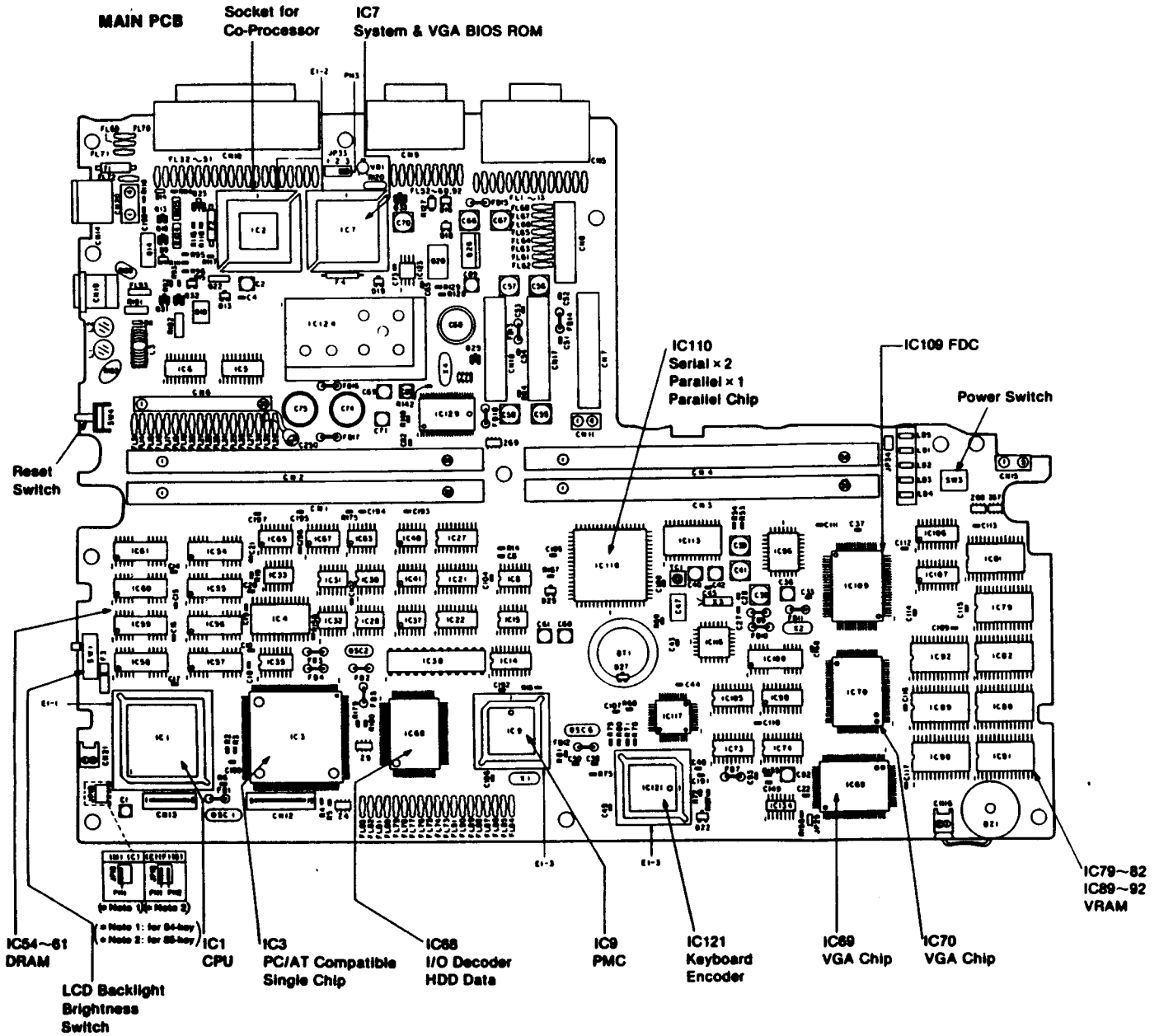

Figure 268. Tandy 2810HD Main Logic Board

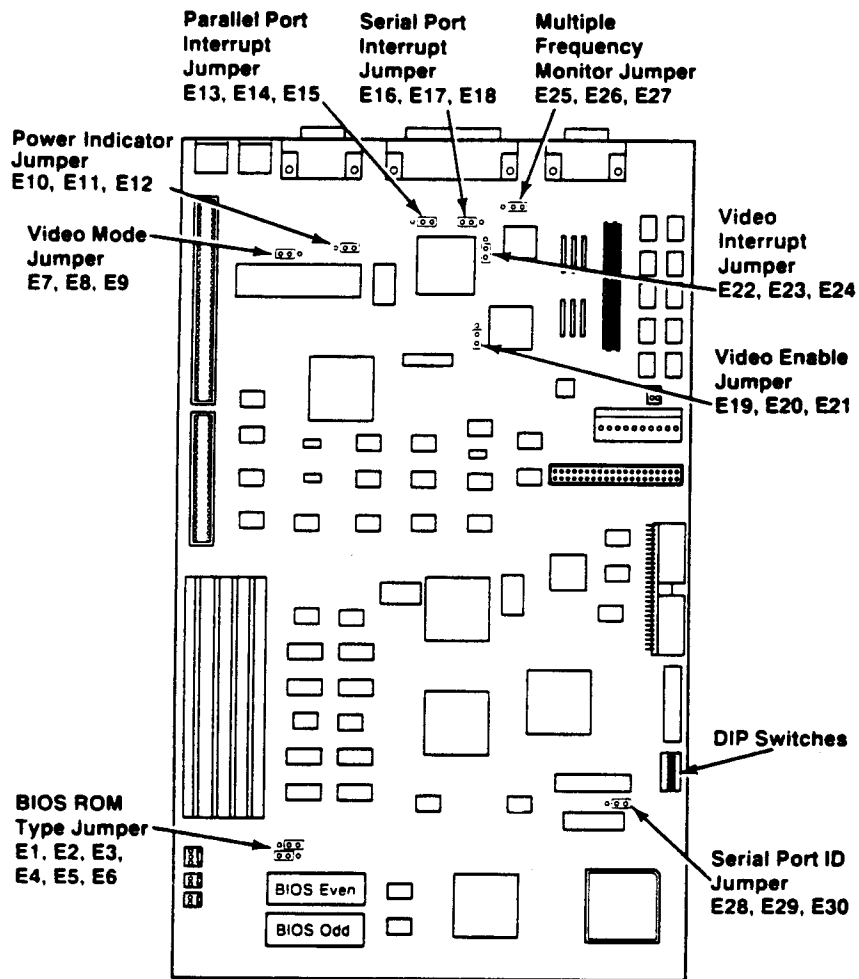
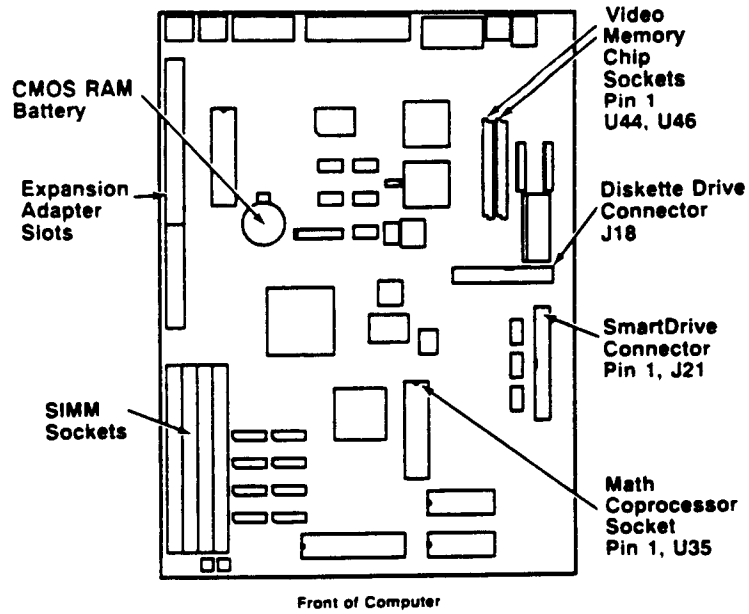

Figure 269. Tandy 4020SX Main Logic Board

Slots and Connectors



Jumpers

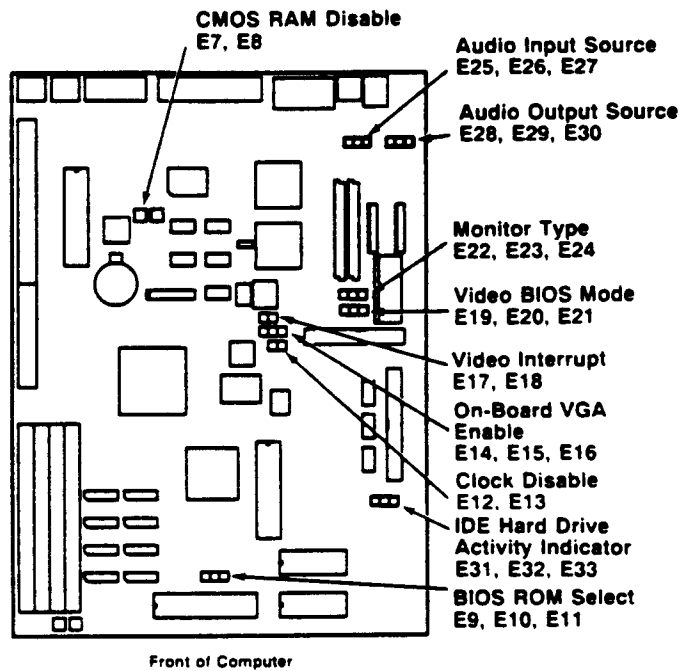

Figure 270. Tandy 2500XL/2 Main Logic Board

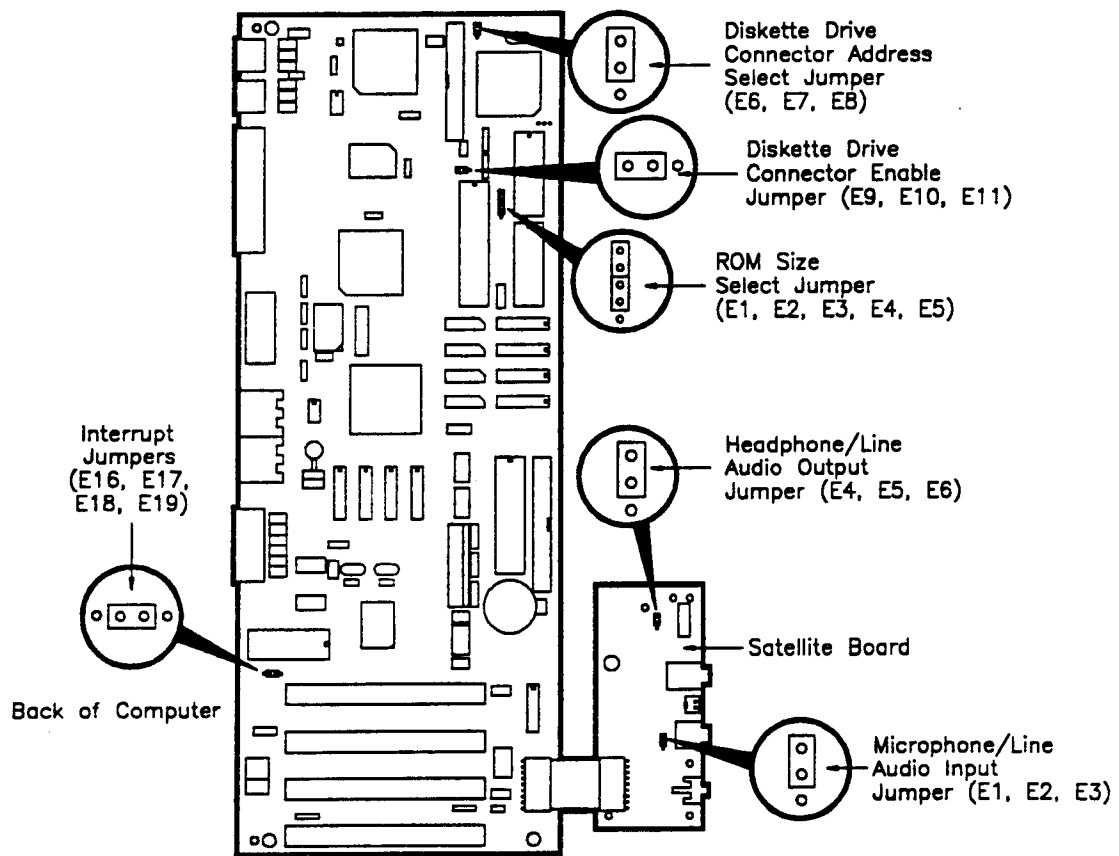

Figure 271. Tandy 1000TL/3 Main Logic Board

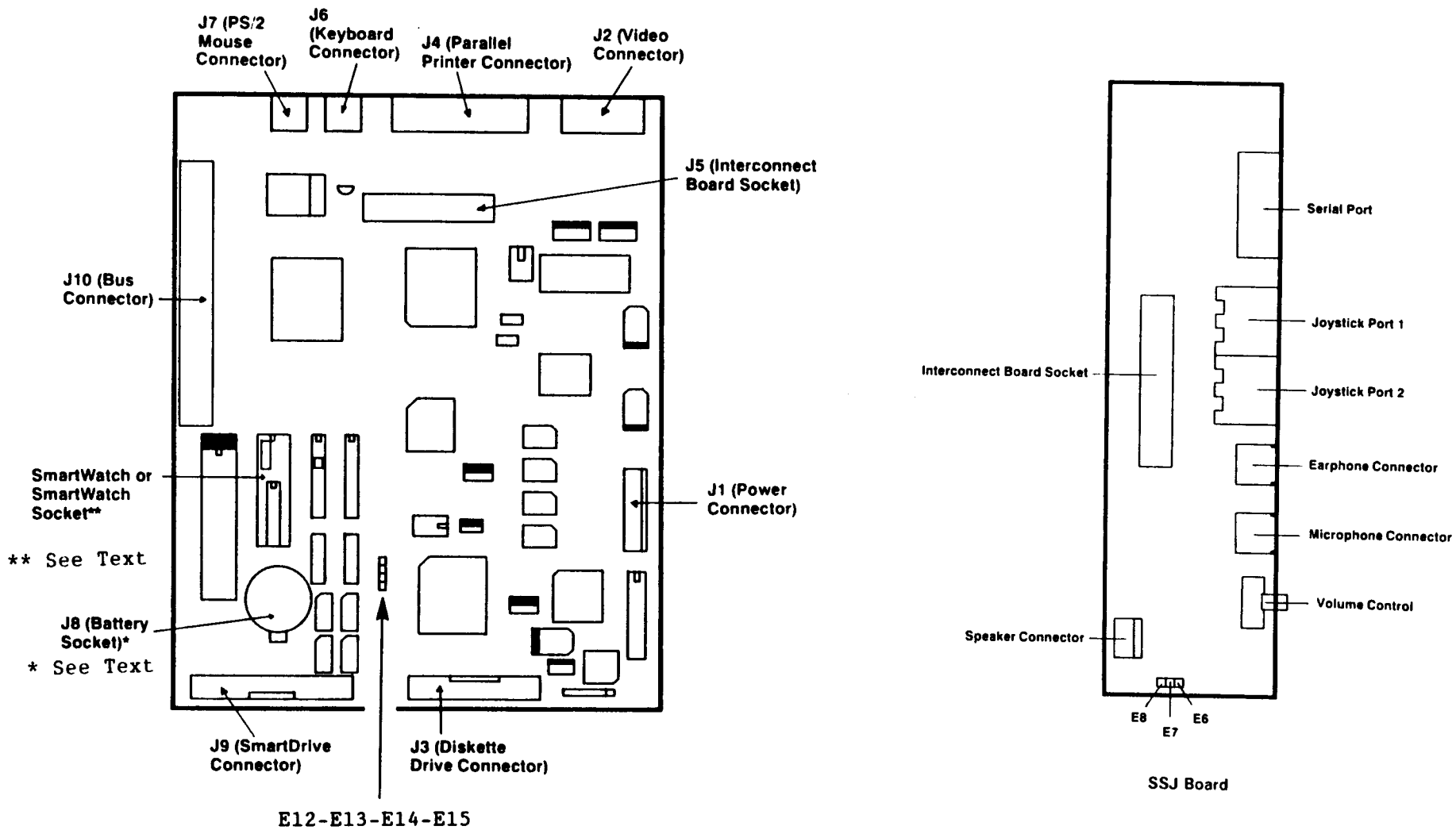

Figure 272. Tandy 1000RL/HD Main Logic Board
Sound/Serial/Joystick Board (SSJ Board)

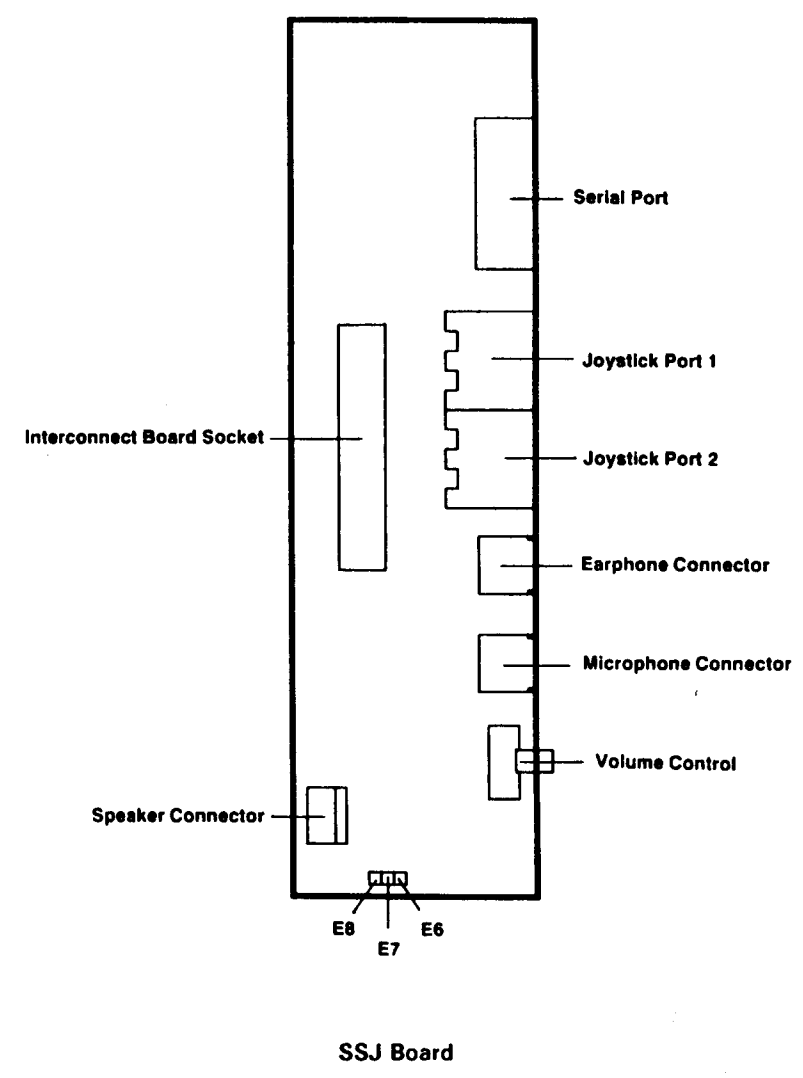
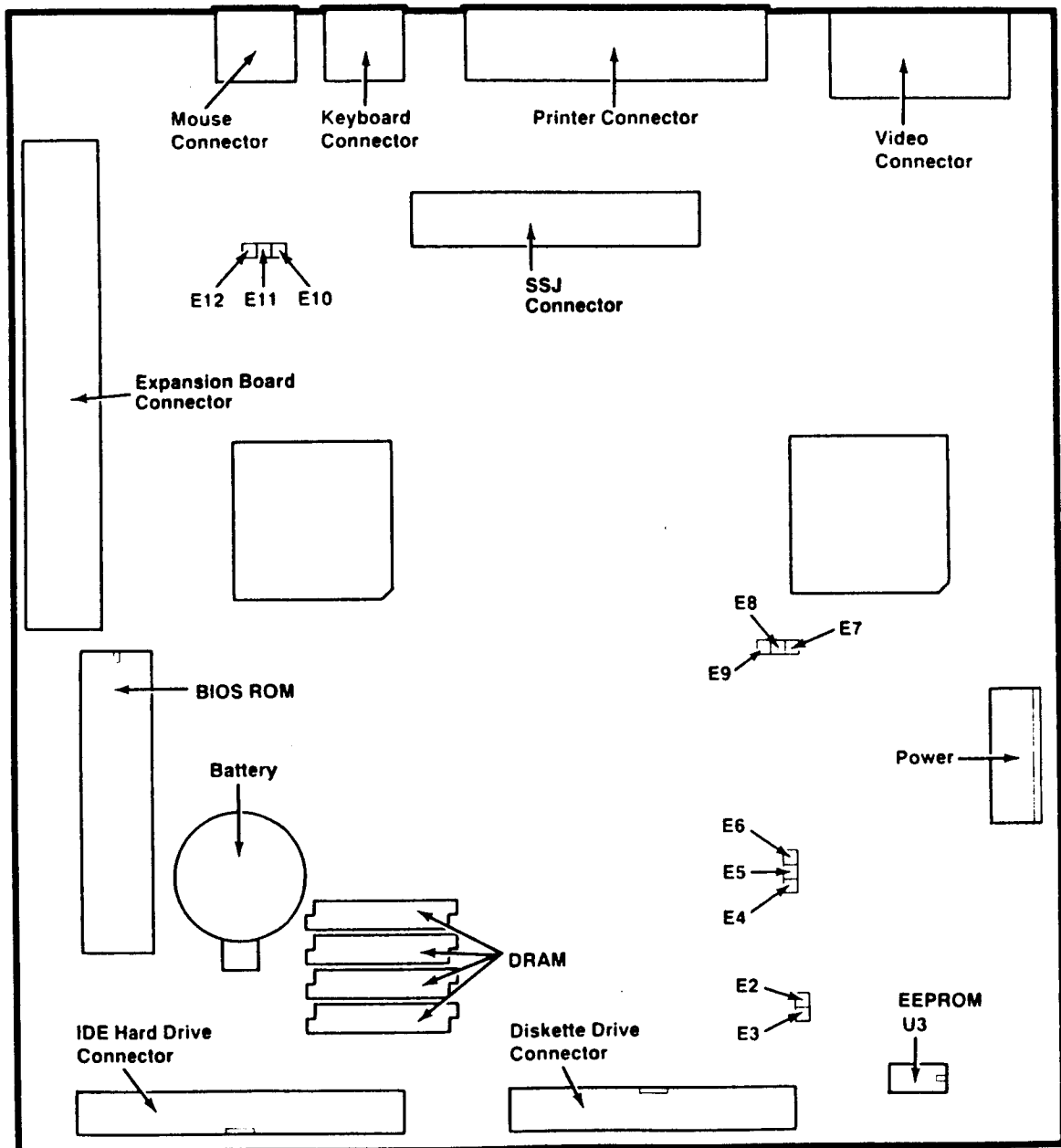
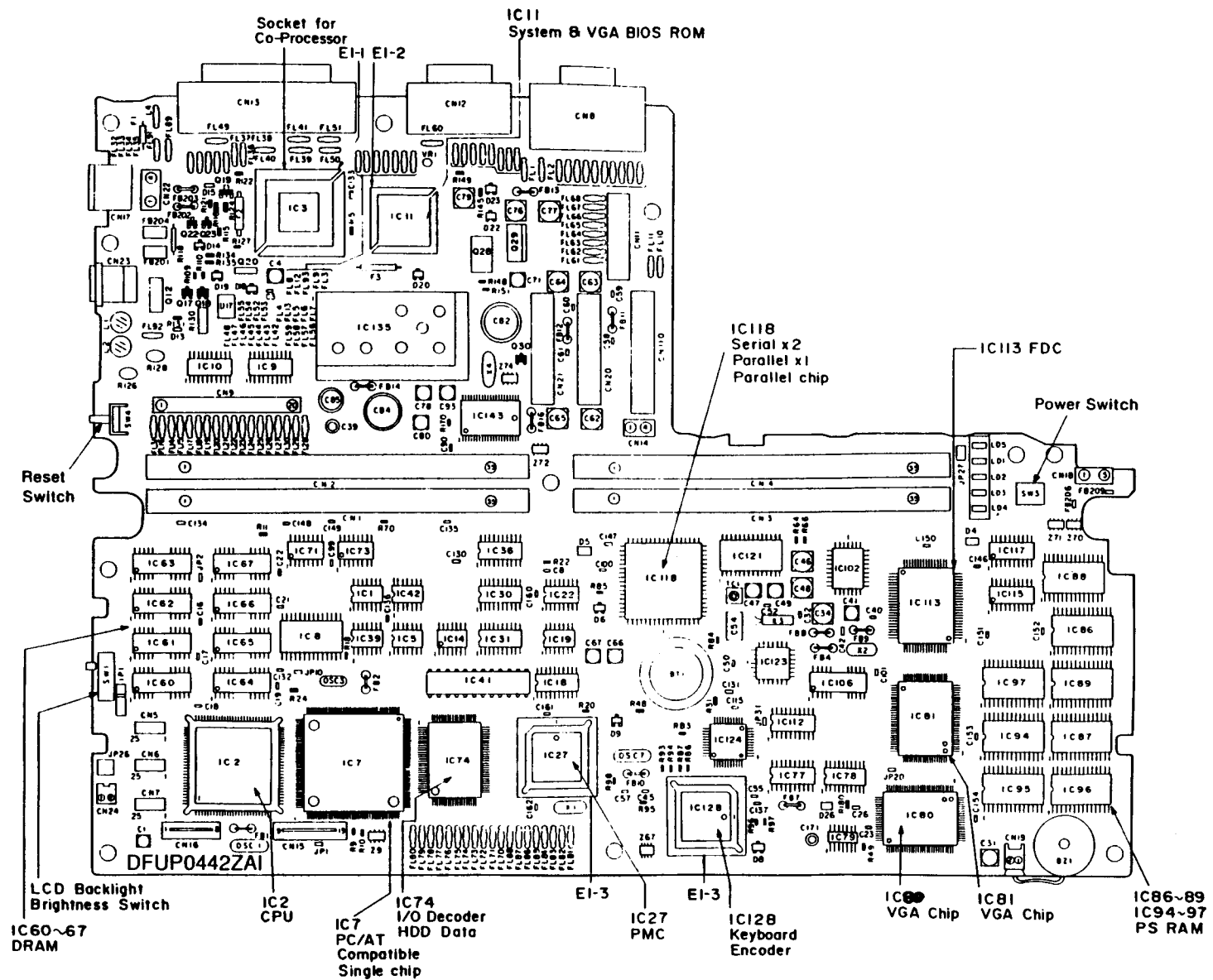

Figure 273. Tandy 1000RLX/HD Main Logic Board
Sound/Serial/Joystick Board (SSJ Board)



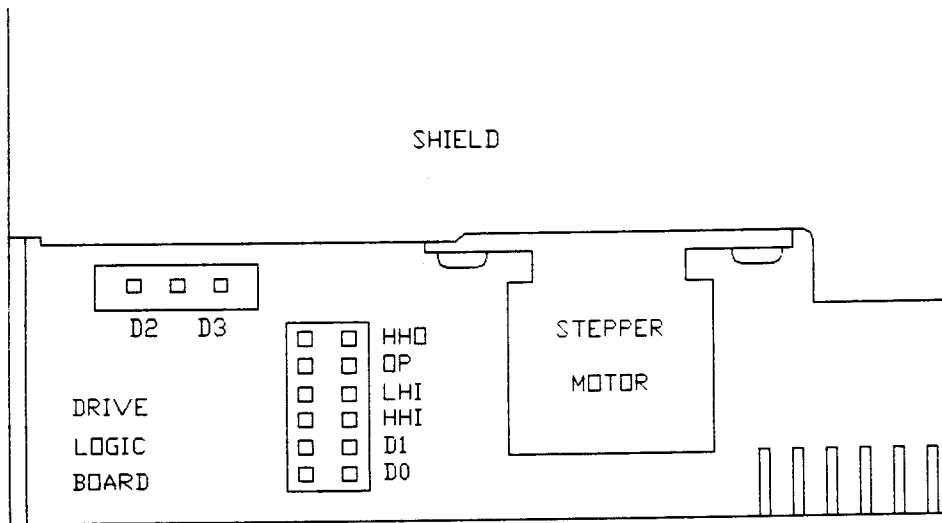

Figure 275. Teac FD-235HF-106U 3 1/2" 1.44MEG Floppy Drive

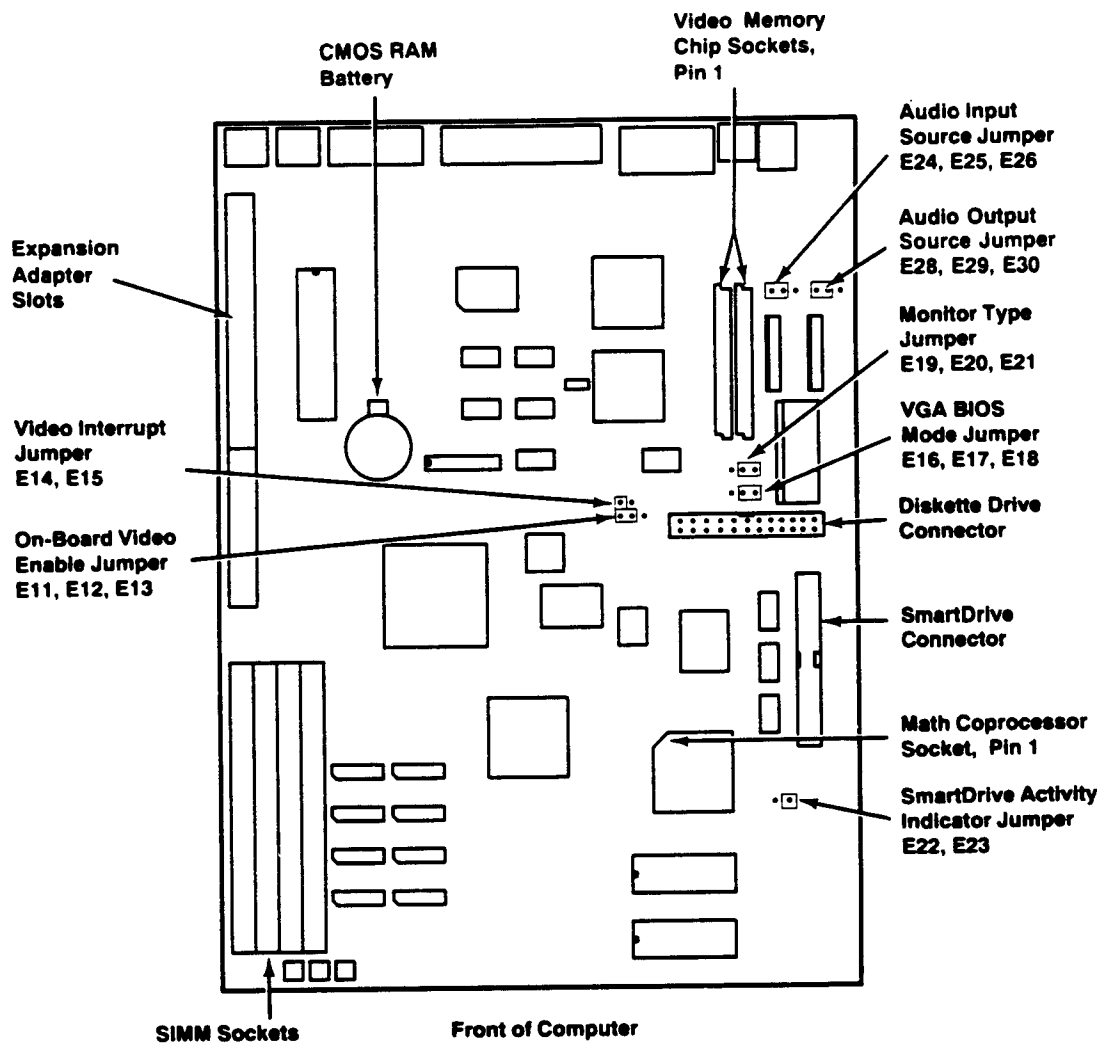

Figure 276. 2500SX Main Logic Board

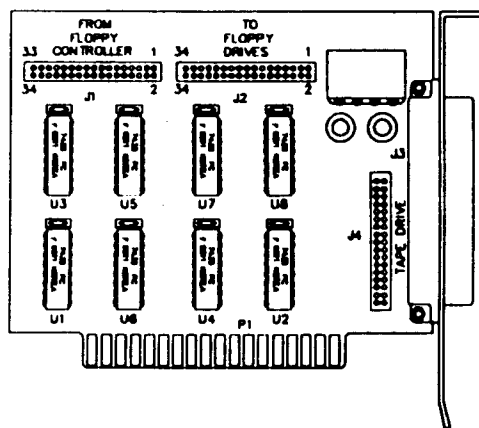

Figure 277. CMS Tape Drive Mux Adapter

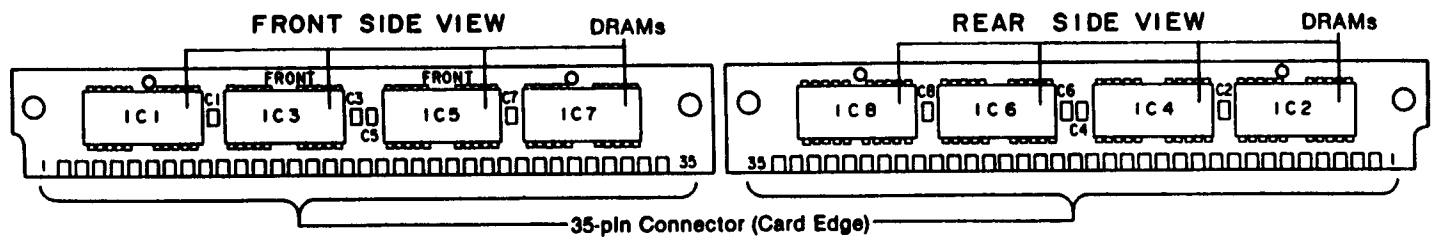

Figure 278. 1 Meg Memory Expansion SIMM for Tandy 1500/2810

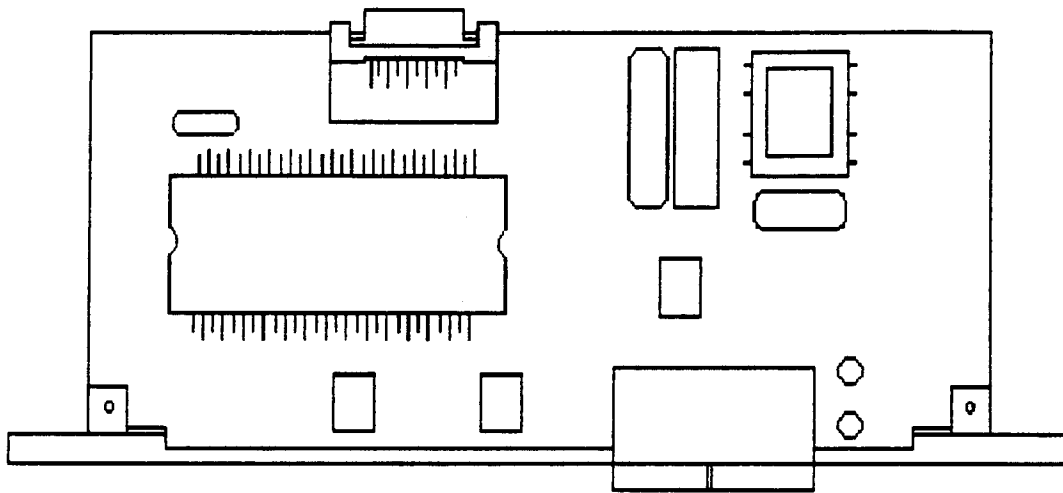

Figure 279. 2400 Baud Modem for Tandy 2800

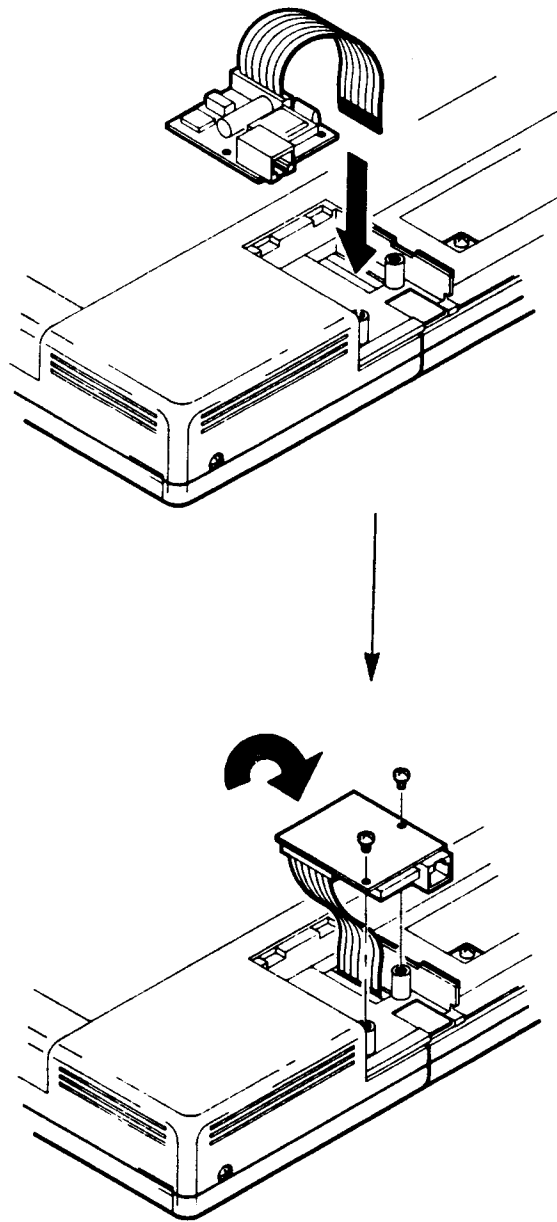

Figure 280. 2400 Baud Modem for Tandy 1500/2810/3810

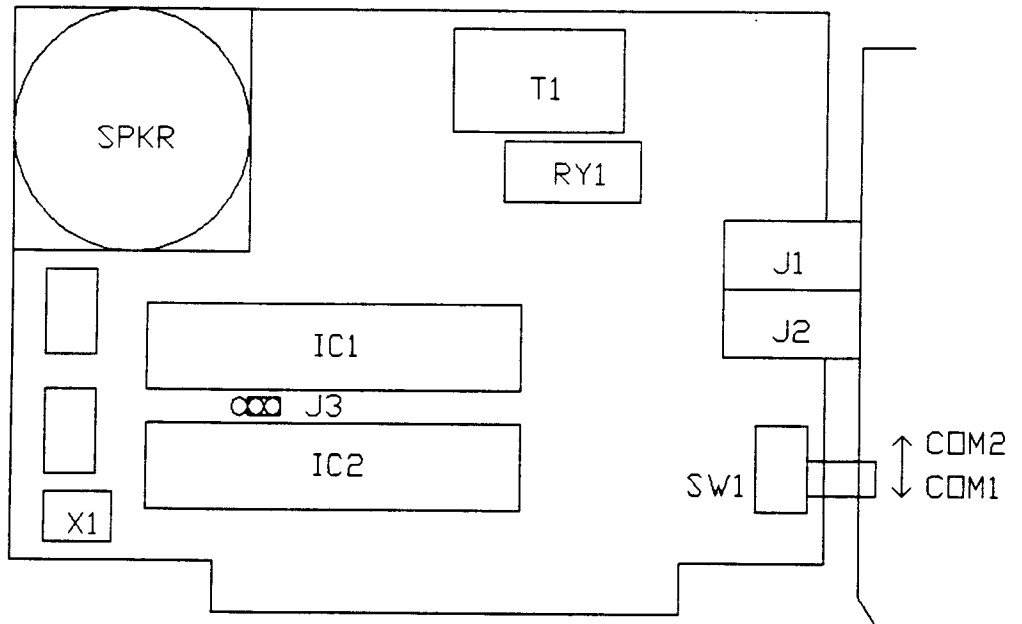

Figure 281. 1200 Baud Internal Modem Board Revision F

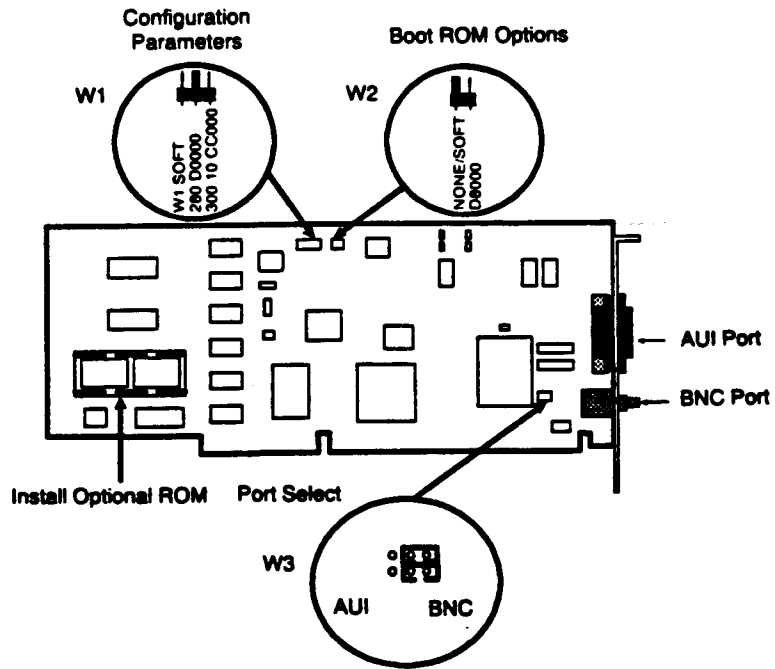

Figure 282. Tandy Ethernet Plus Adapter Board

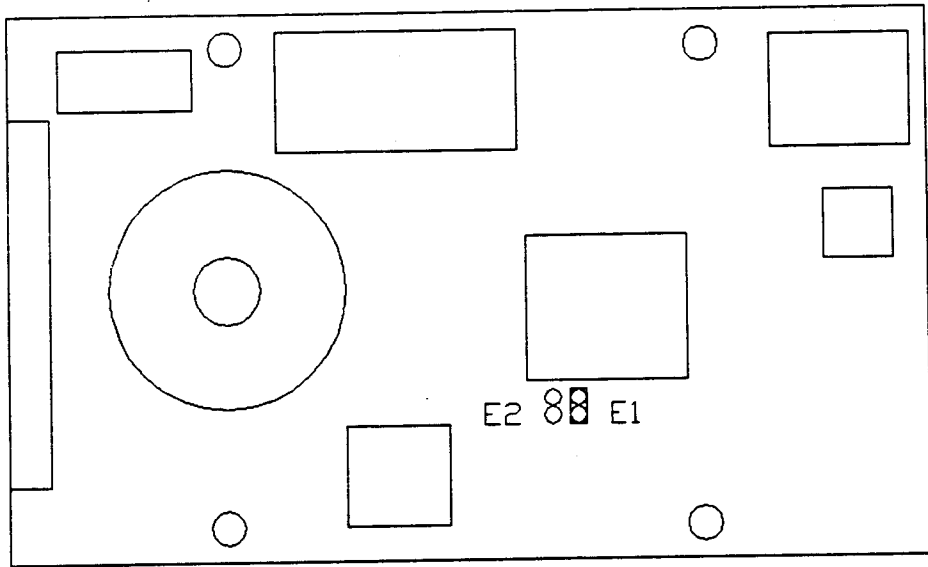
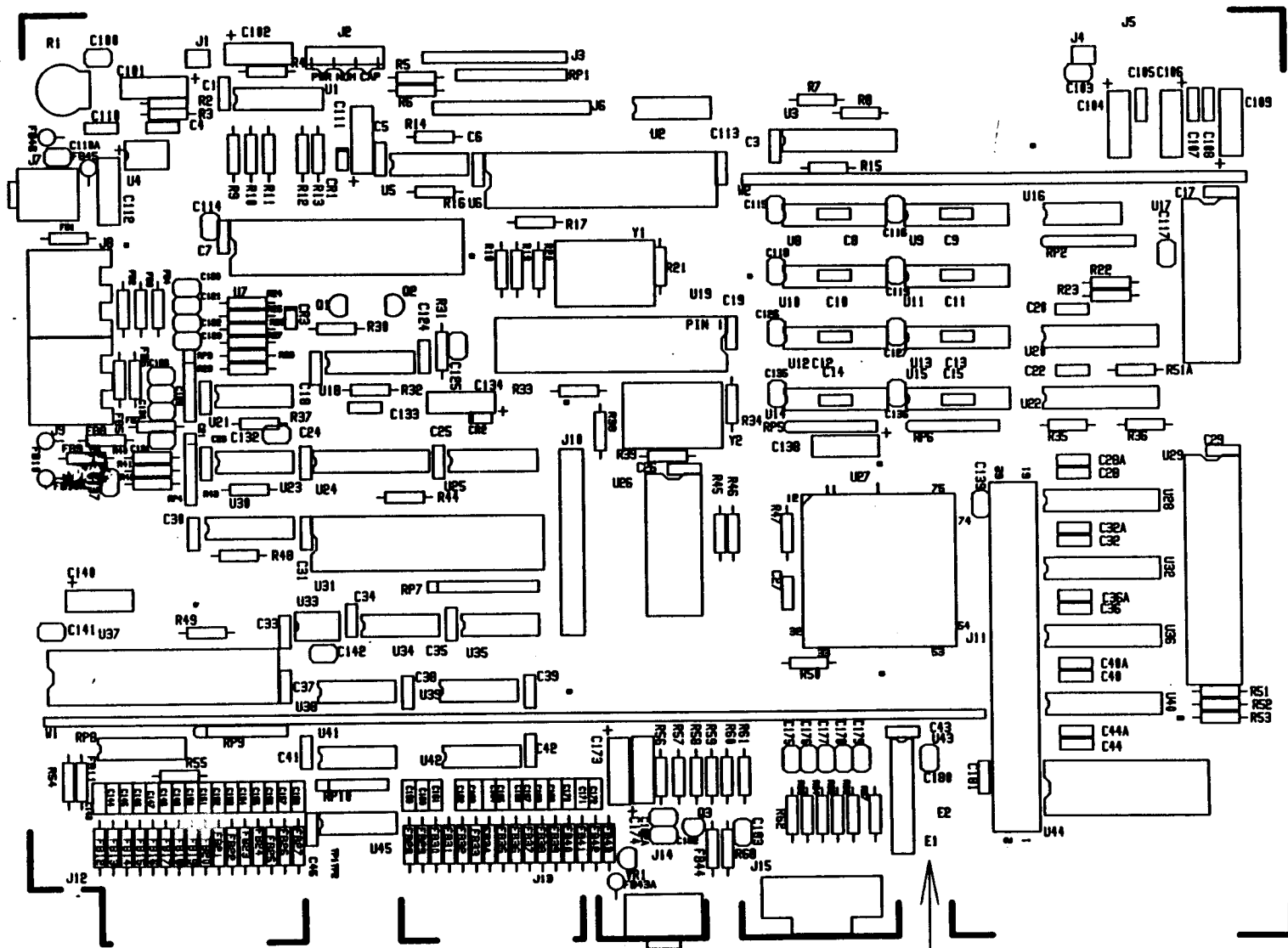

Figure 283. Conner CP-2064 60 Meg IDE Hard Drive



E1-E2
See Text

Figure 284. Tandy 1000 EX Main Logic Board Revision D

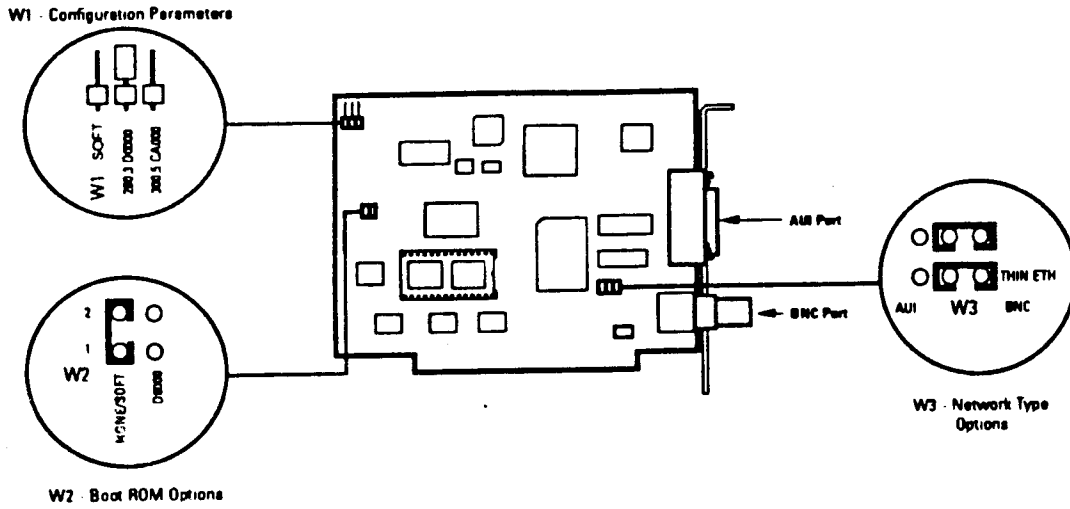

Figure 285. Tandy Etherlink Board (25-5505A/B)

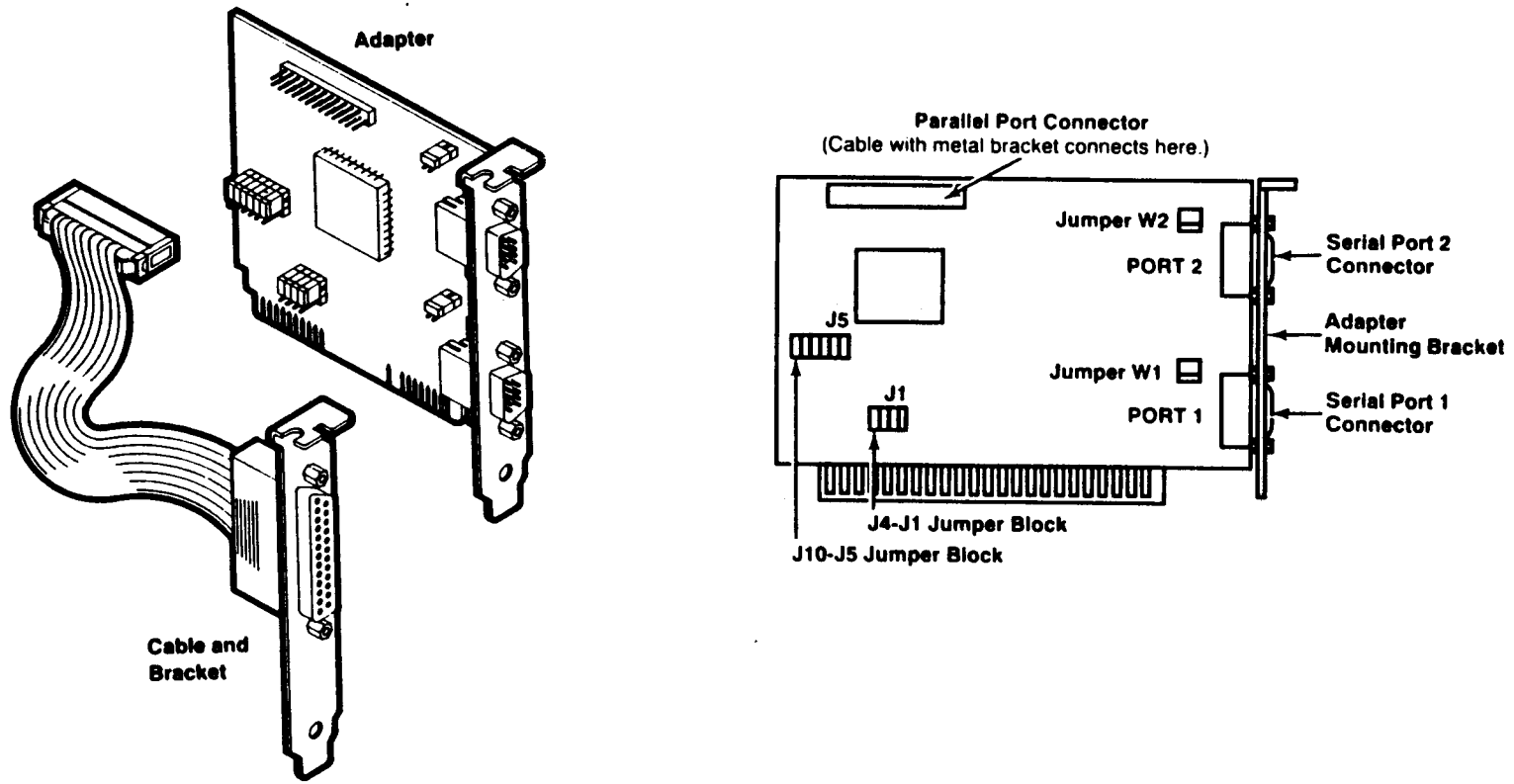

Figure 286. Dual Serial/Parallel Board (25-4025)

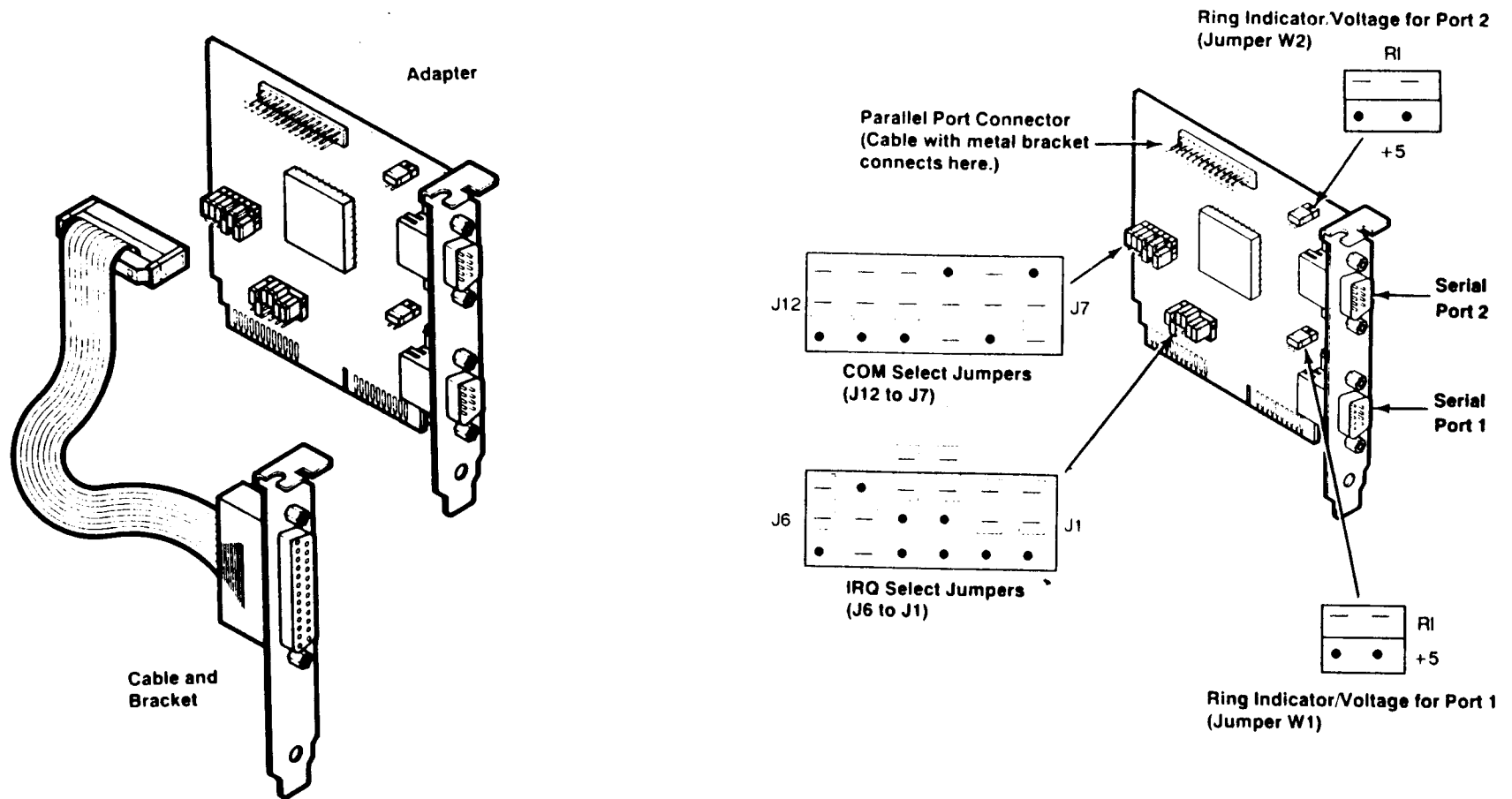

Figure 287. Dual Serial/Parallel Board (25-4025A)
 Shown set to Factory Defaults (See Text)

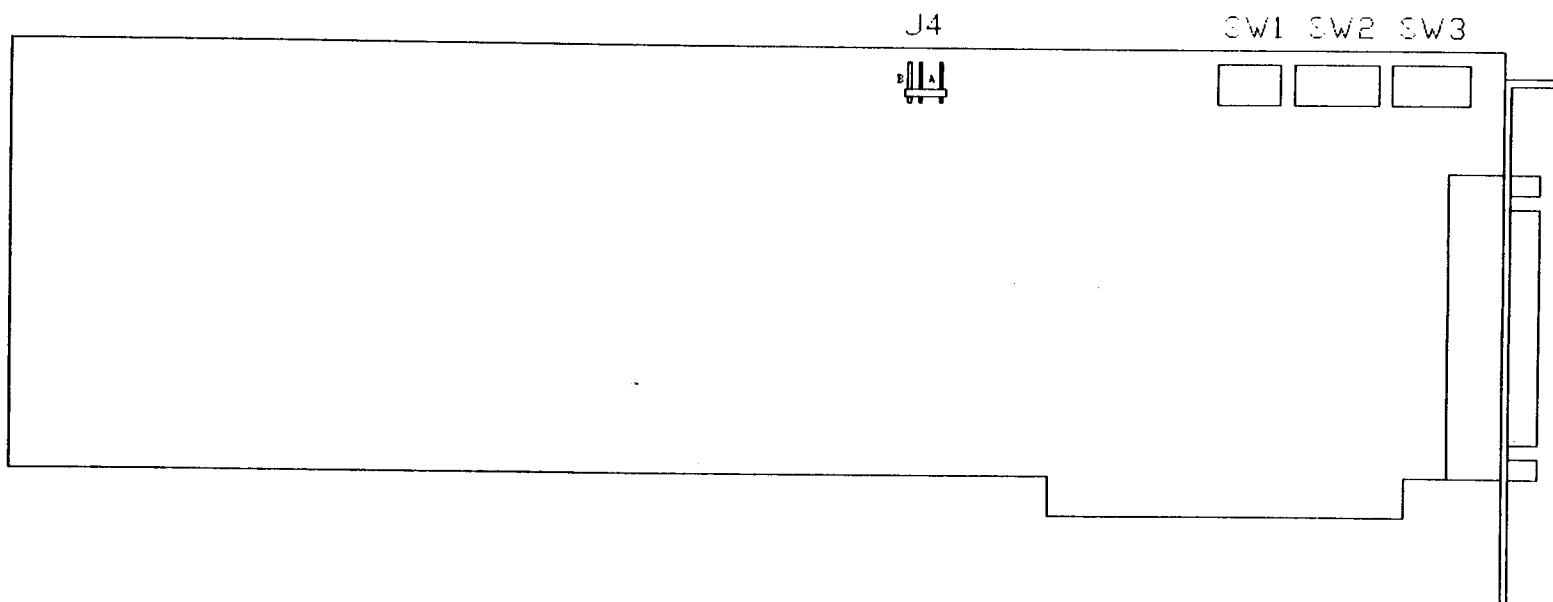

Figure 288. ARNET Multiport 4 Port Board

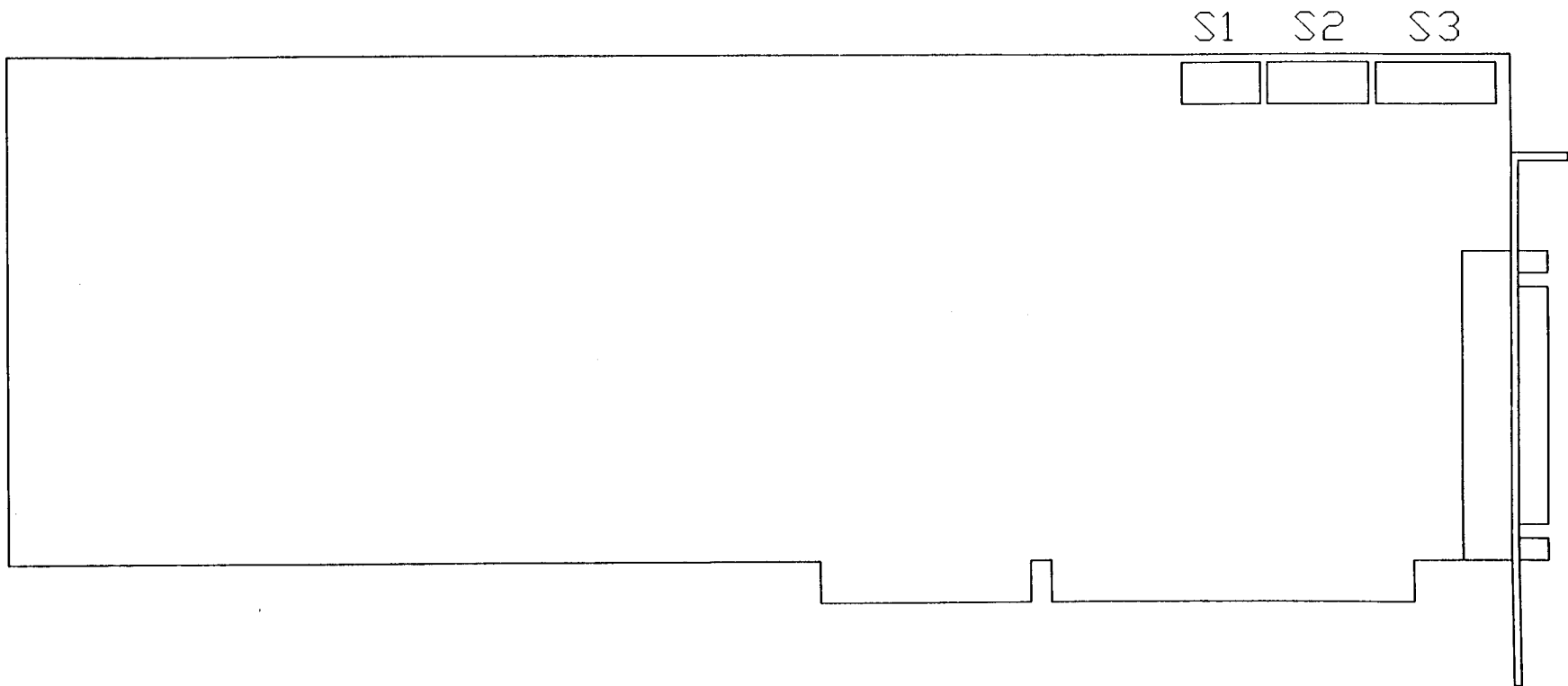

Figure 289. ARNET Octaport 8 Port Board

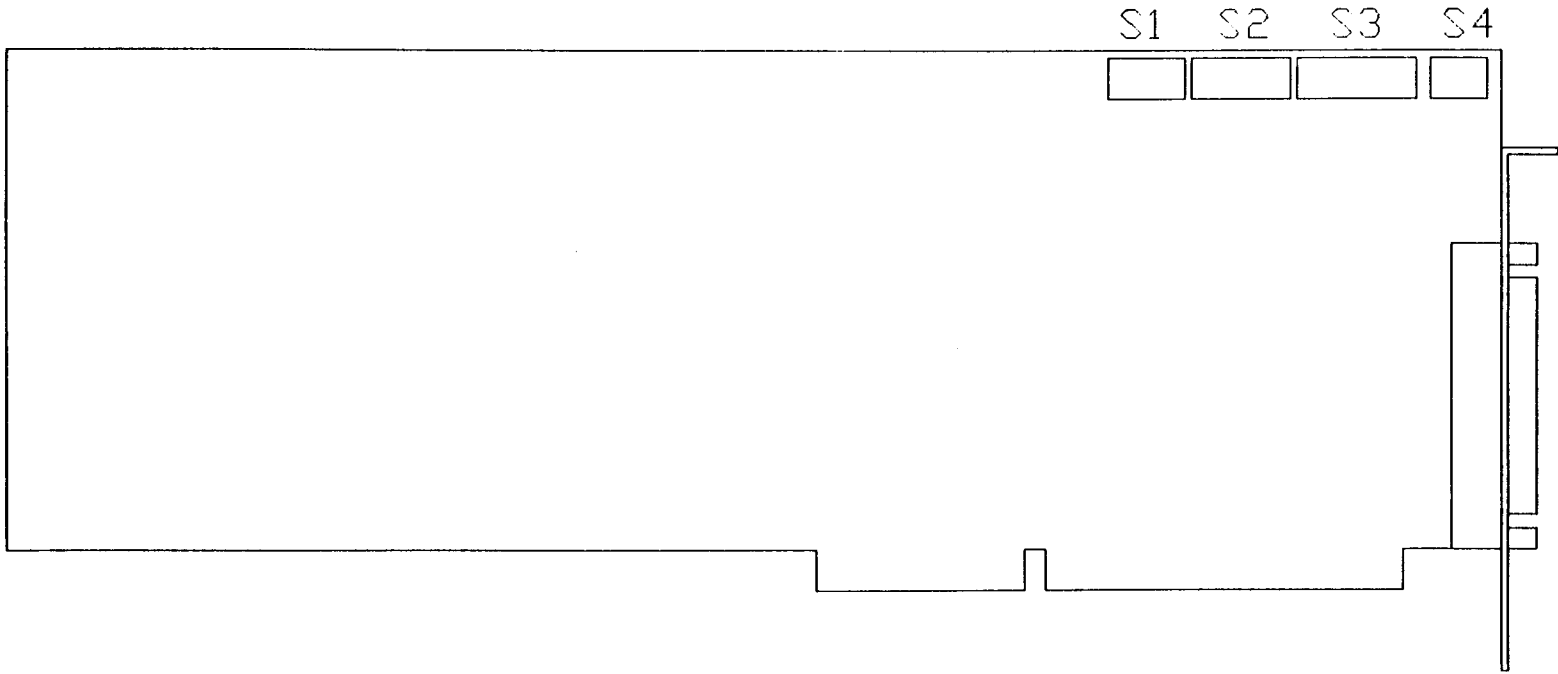

Figure 290. ARNET Smartport 16 Port Board

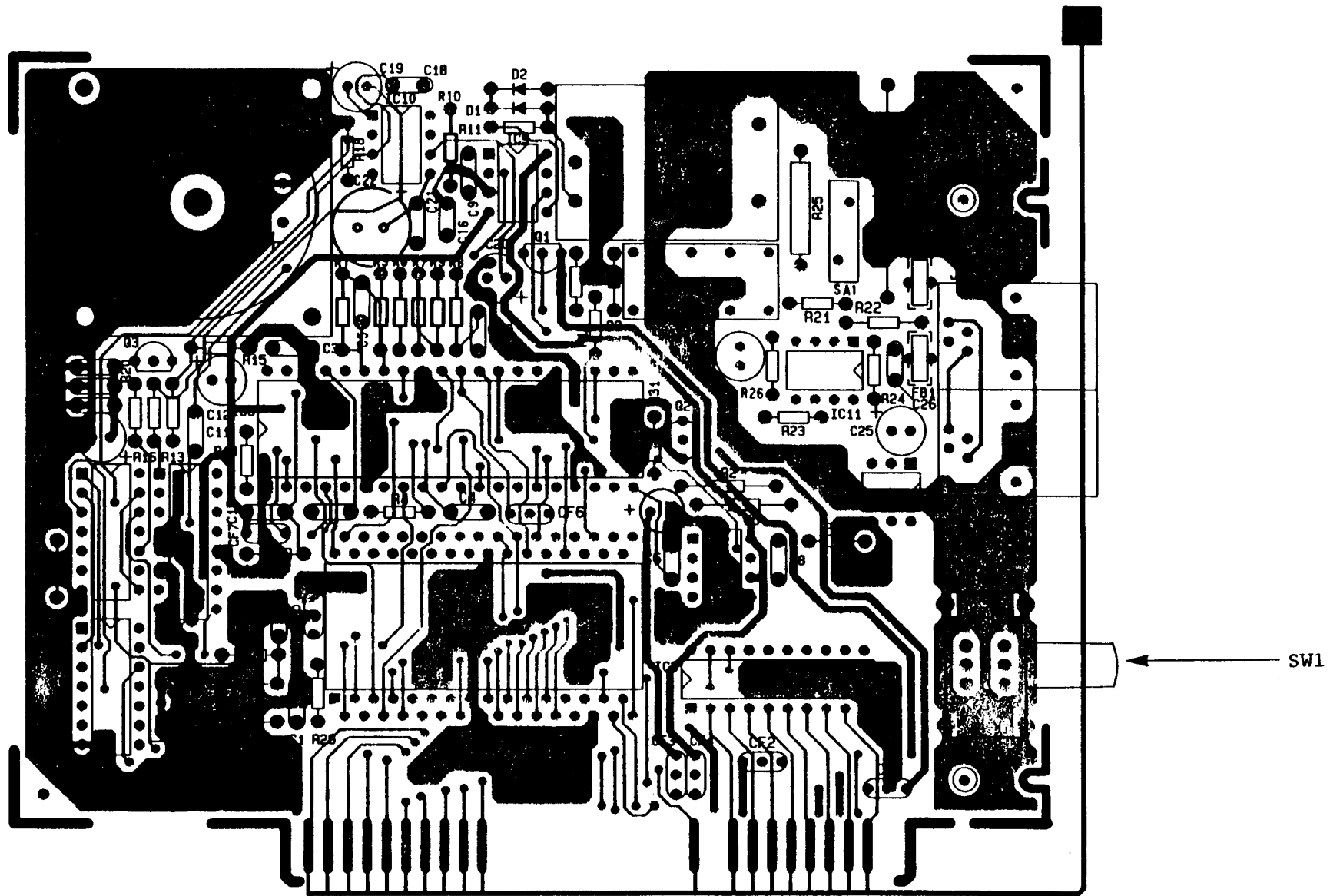

Figure 291. 2400 Baud Internal Modem Board Revision B

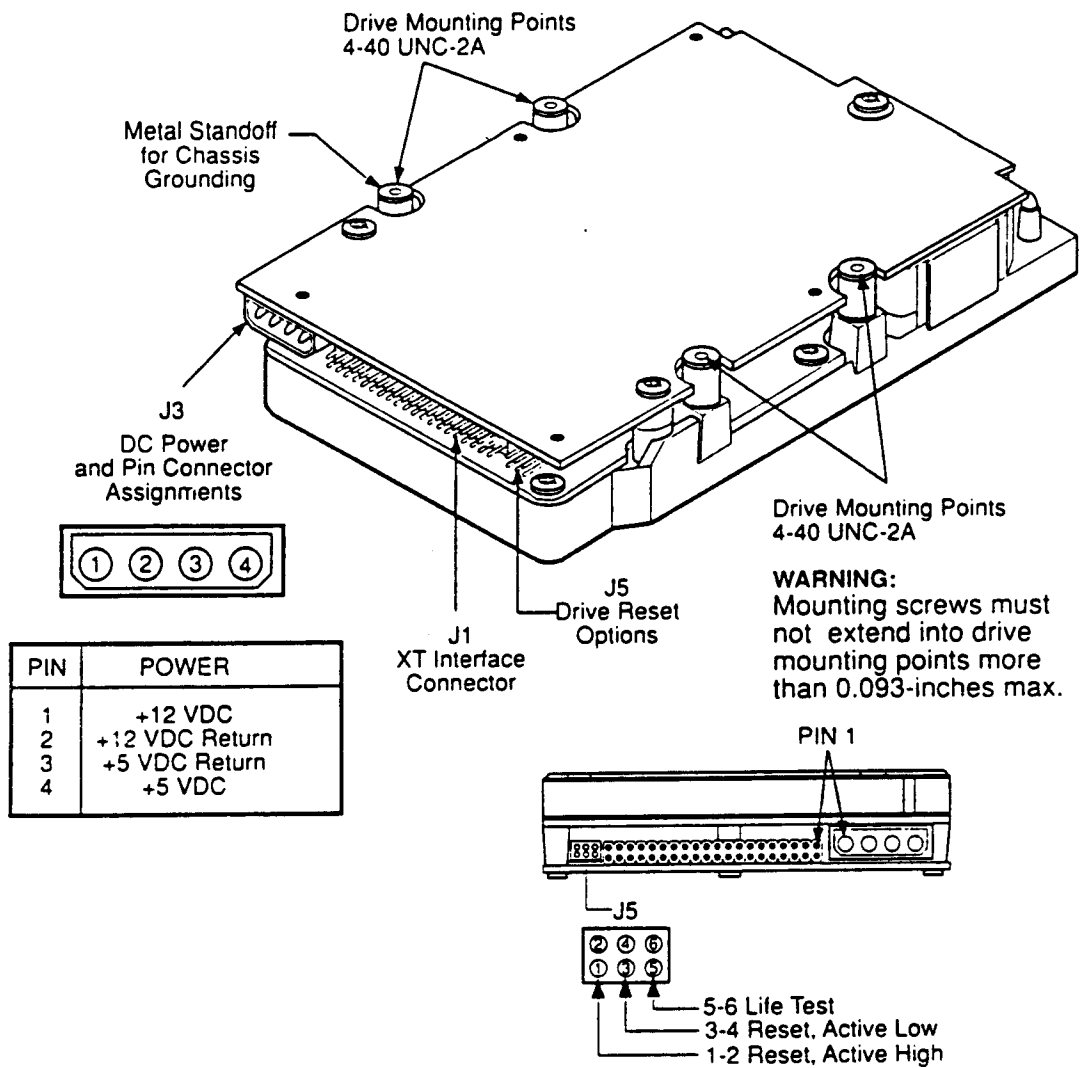

Figure 292. Seagate ST-325X 20 Meg XT IDE Hard Drive

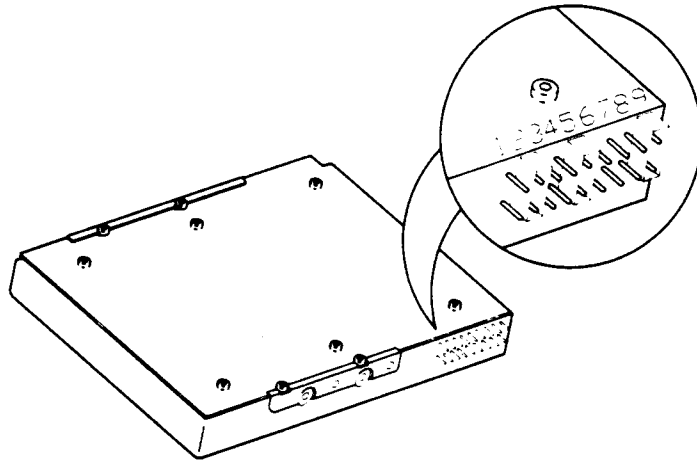

Figure 293. Seagate ST-351A/X 40 Meg XT/AT IDE Hard Drive

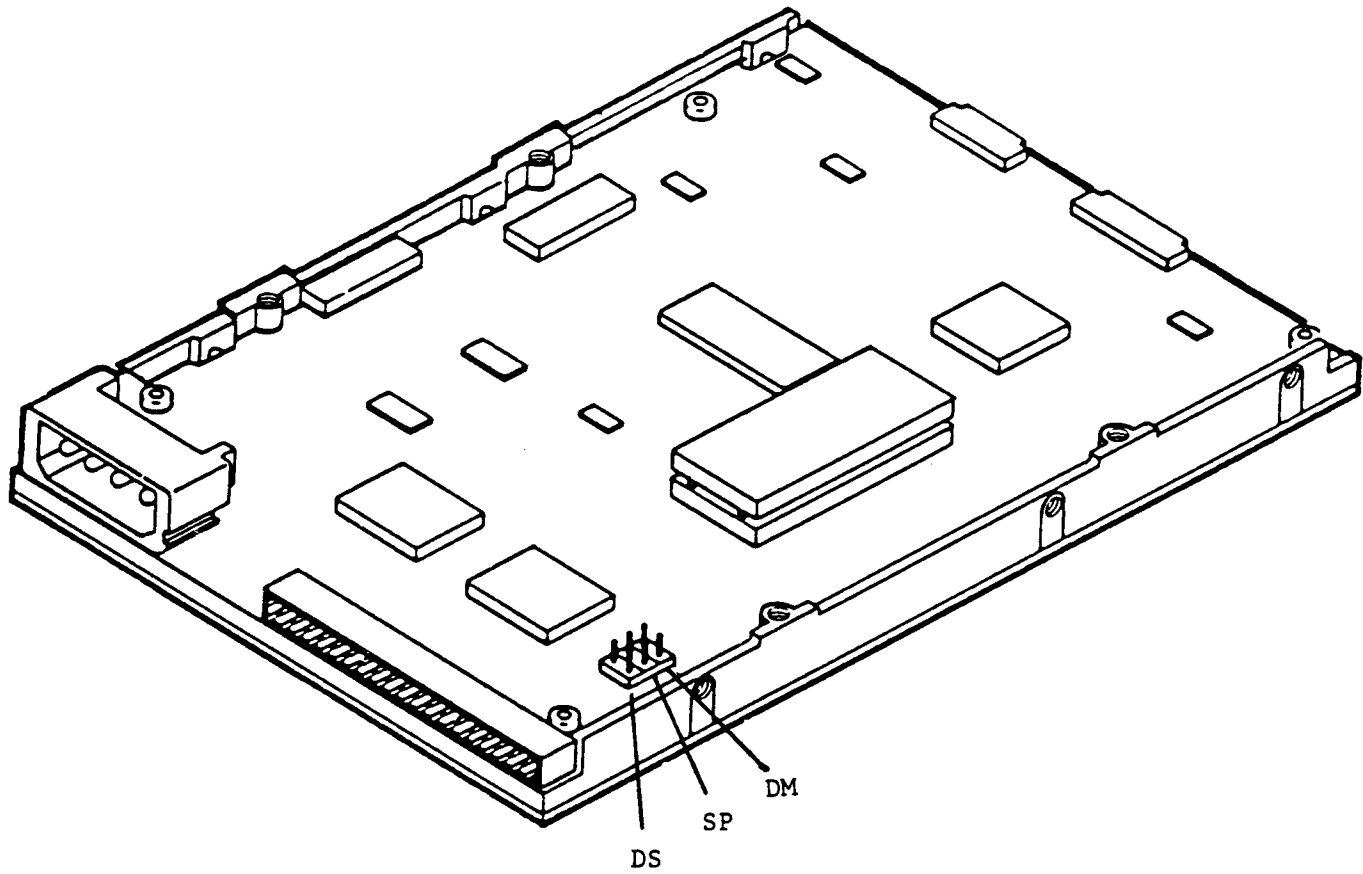
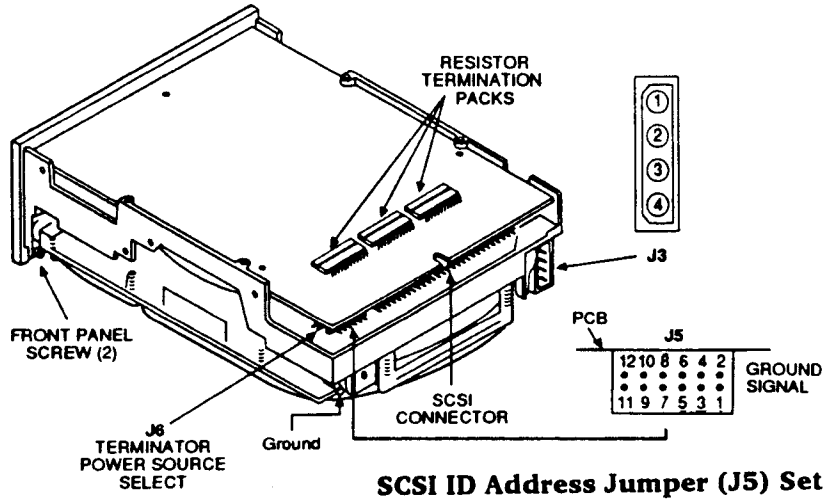
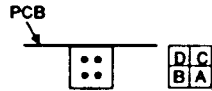

Figure 294. Quantum LPS52 52 Meg Smart Drive
Quantum LPS105 105 Meg Smart Drive



SCSI ID Address Jumper (J5) Settings



JUMPER	TERMINATION POWER
A-B	Power from Power Connector
A-C	Power from SCSI Bus
A-C & B-D	Power from Power Connector and Provide to SCSI Bus
B-D	Only Provide to SCSI Bus

	12 10 8 6 4 2	11 9 7 5 3 1	
SCSI ID = 0	••••••	••••••	Plns 1-6 - SCSI ID 1-2: Least Significant Bit 3-4: Next Significant Bit 5-6: Most Significant Bit
SCSI ID = 1	••••••	••••••	
SCSI ID = 2	••••••	••••••	
SCSI ID = 3	••••••	••••••	
SCSI ID = 4	••••••	••••••	
SCSI ID = 5	••••••	••••••	
SCSI ID = 6	••••••	••••••	
SCSI ID = 7	••••••	••••••	
Enable Parity	••••••	••••••	
Start/Stop	••••••	••••••	
Ext. Spindle Syn.	••••••	••••••	

Figure 295. 202 Meg SCSI Hard Drive

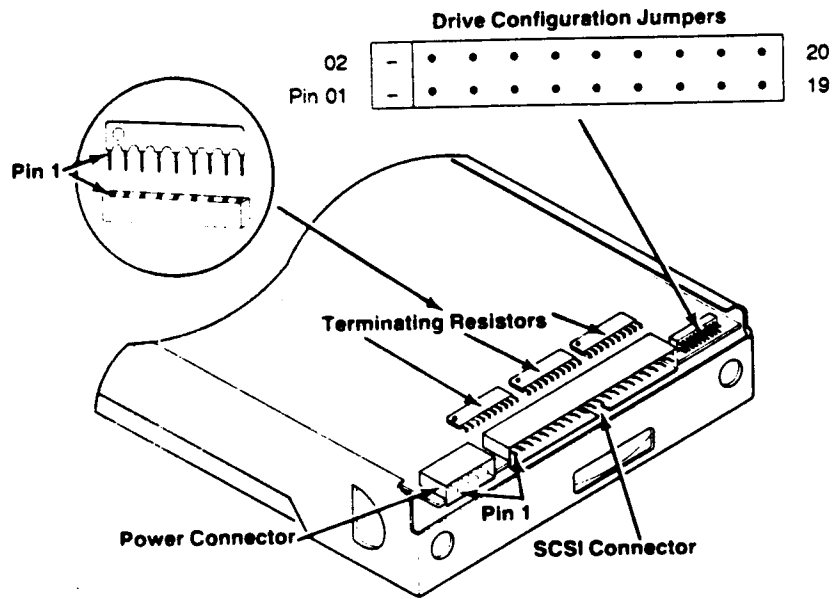
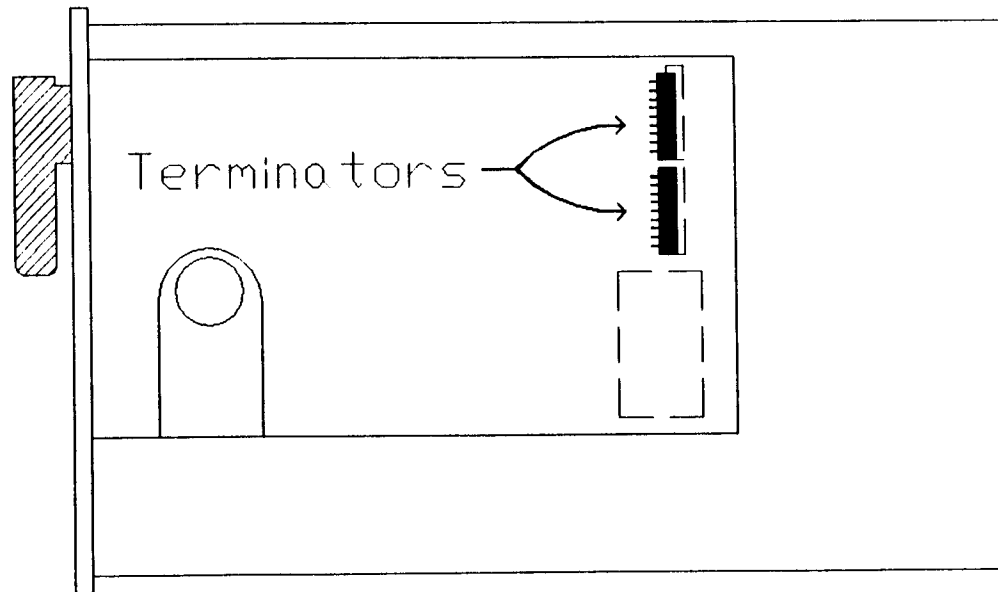
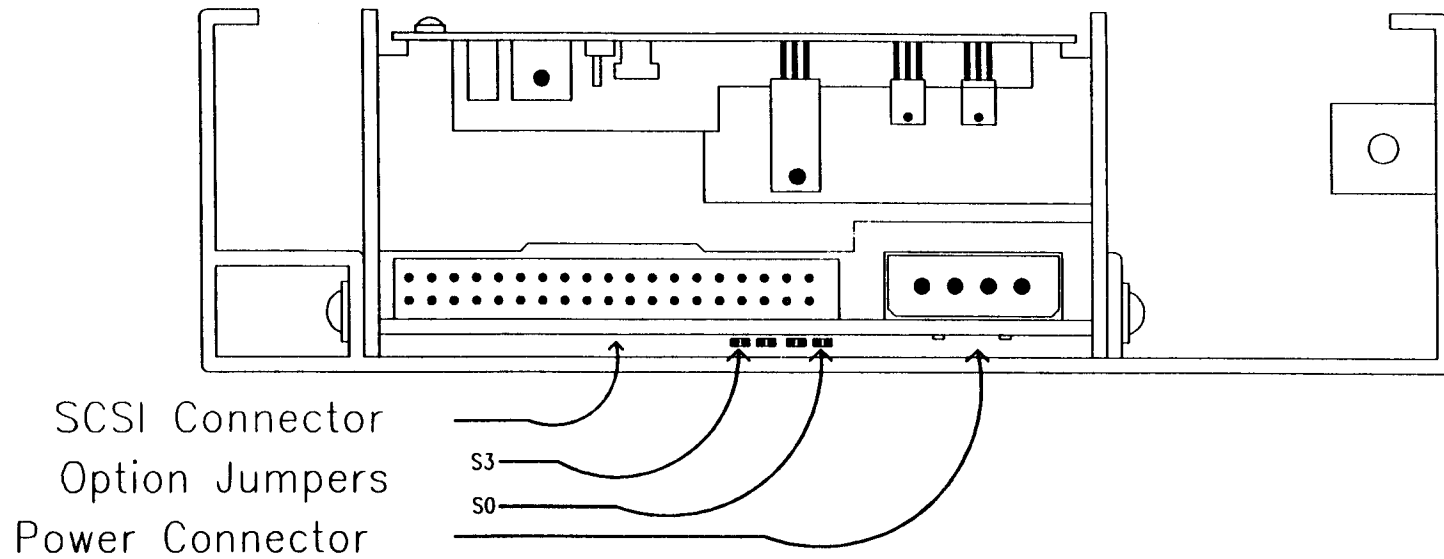
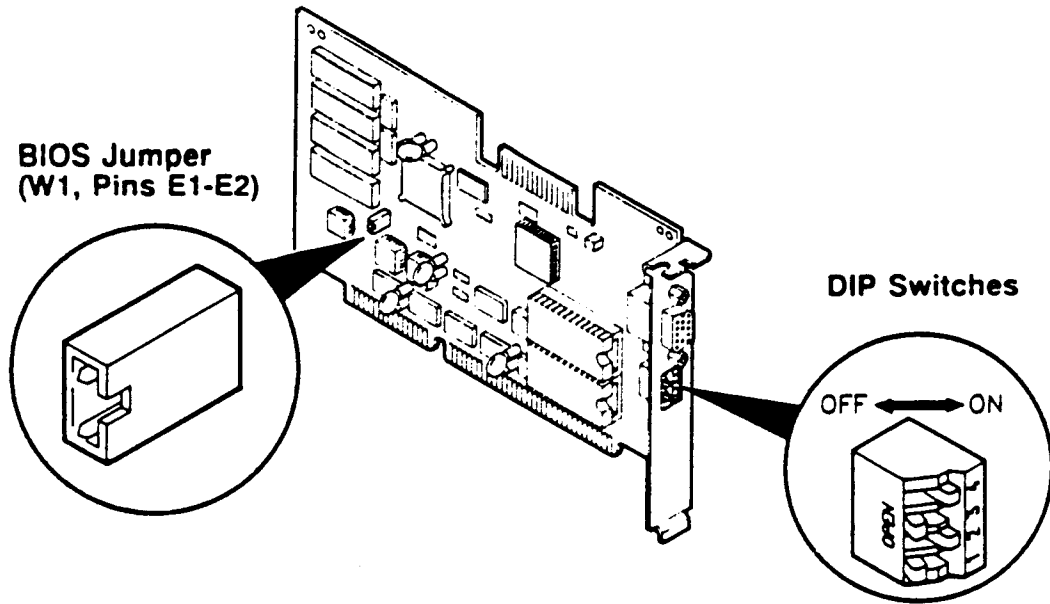

Figure 296. 440 Meg SCSI Hard Drive



Bottom View

Figure 297. 160 Meg SCSI Tape Drive



Explanations of the factory settings are listed in the following table:

Jumper/ Switch	Factory Setting	Explanation
W1	Jumper installed	Enables normal operation using AutoSense
Switch 1	OFF	Enables standard PS/2-compatible fixed-frequency display timing
Switch 2	ON	Selects PS/2-style as the manner of mode switching; makes all VGA modes available on any monitor
Switch 3	OFF	Not used
Switch 4	ON	Enables 16-bit video memory data path and uses AutoSense for 16-bit BIOS

Figure 298. 16 Bit Super VGA Video Adapter Board

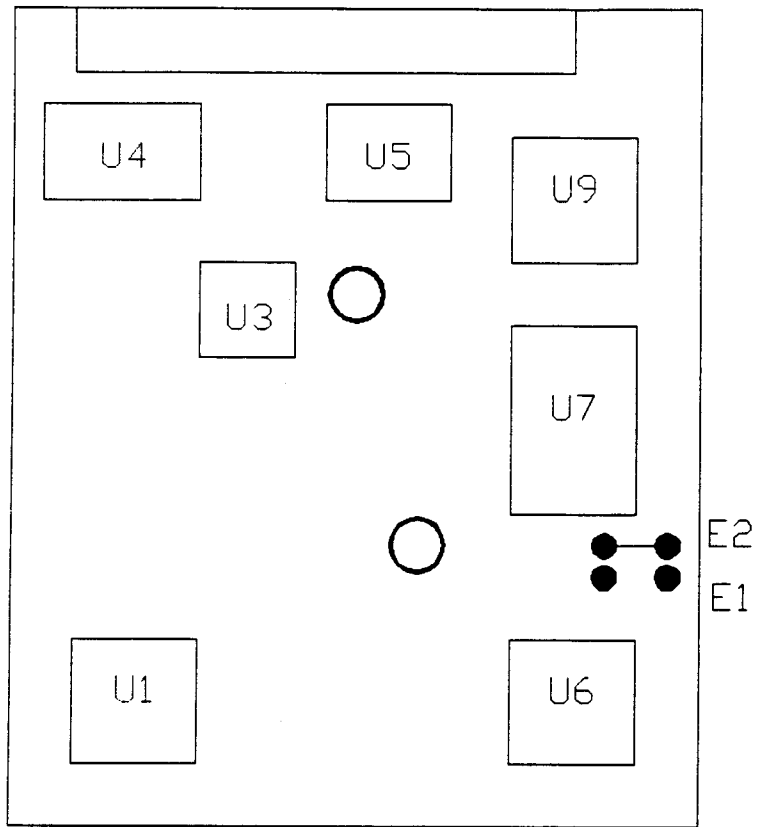

BOTTOM VIEW

Figure 299. Conner CP-2024 20 Meg IDE Hard Drive

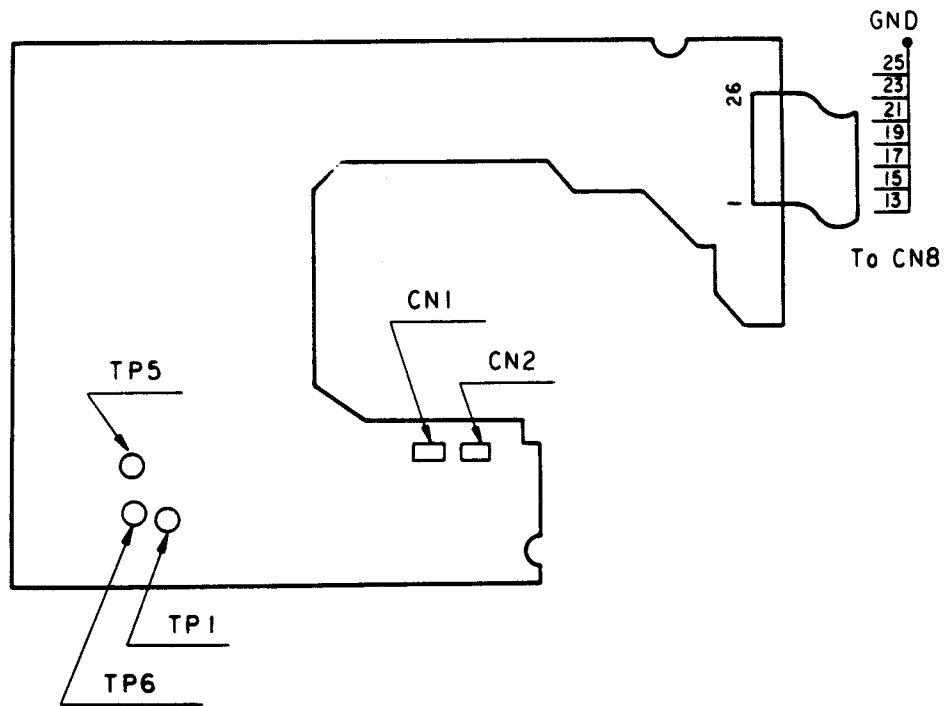

Figure 300. Matsushita EME-263MG 3 1/2 inch 1.44MEG Floppy Drive

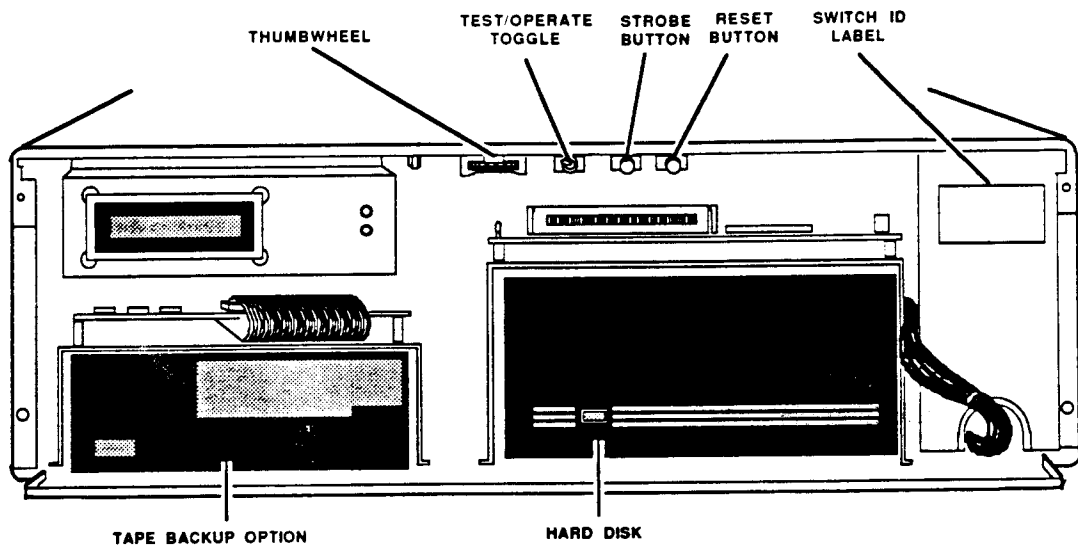
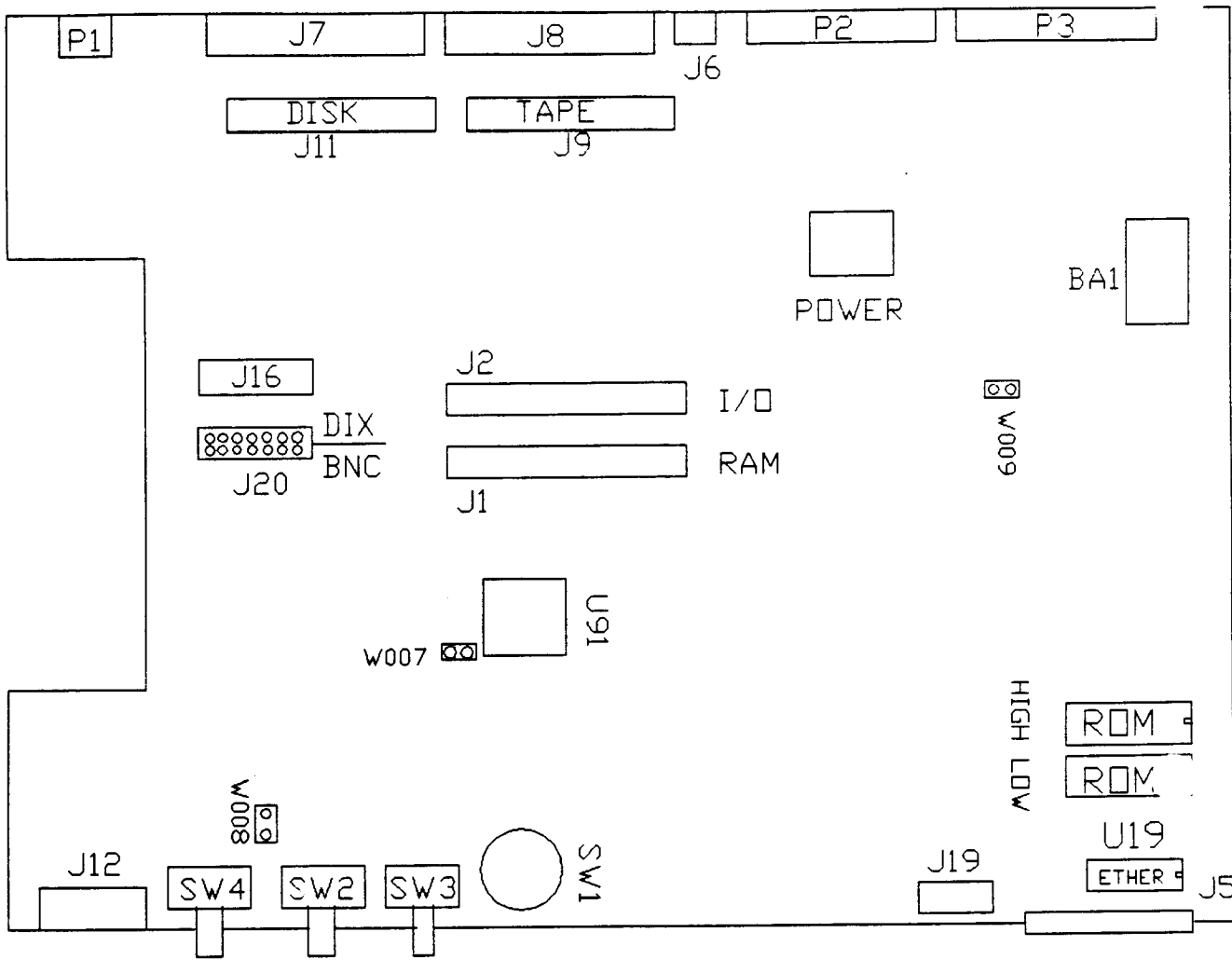

Figure 301. 3SERVER3 Main Unit/Control Panel



3SERVER3

Figure 302. 3SERVER3 Main Logic Board

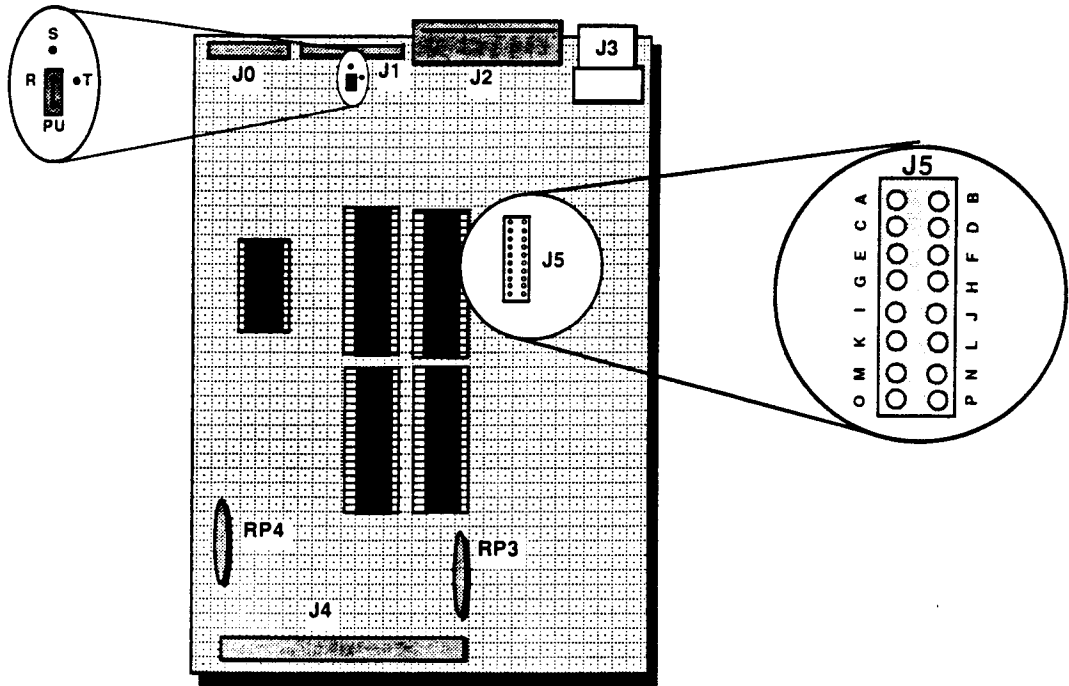

Figure 303. 3SERVER3 Disk Drive Controller Board

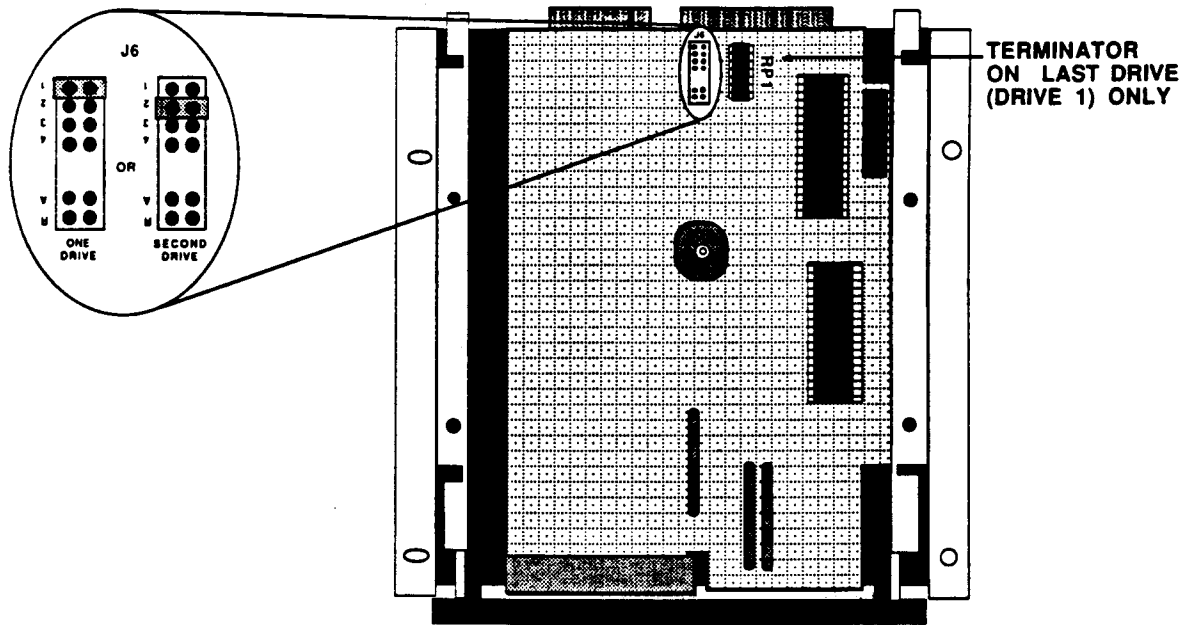

Figure 304. 3SERVER3 Priam Hard Disk Drive

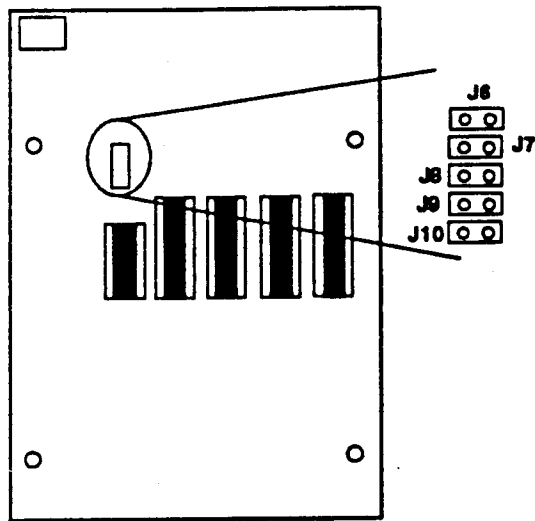
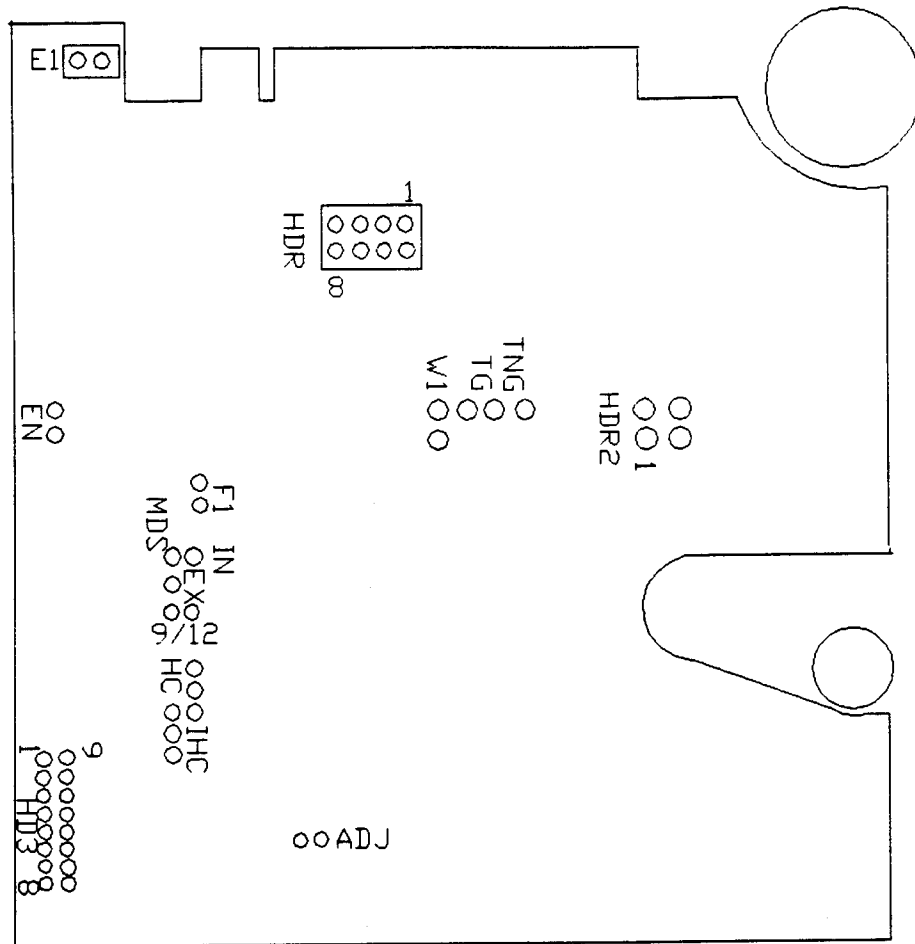

Figure 305. 3SERVER3 Tape Drive Controller Board



WANGTEK 5099EN24

Figure 306. 3SERVER3 Wangtek Tape Drive

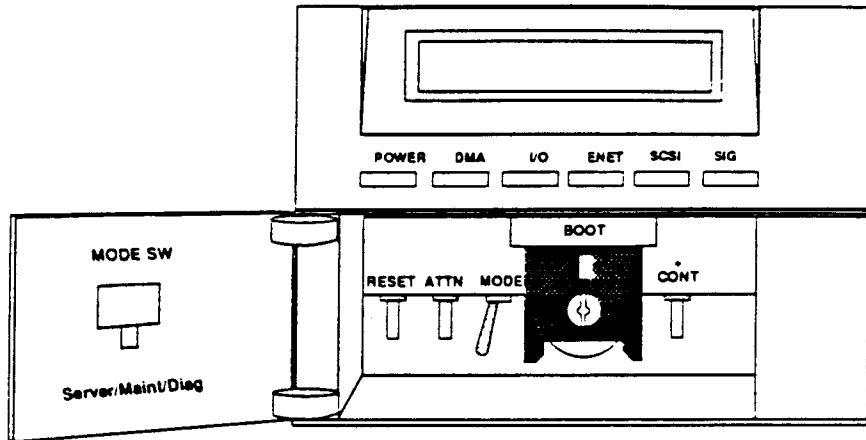
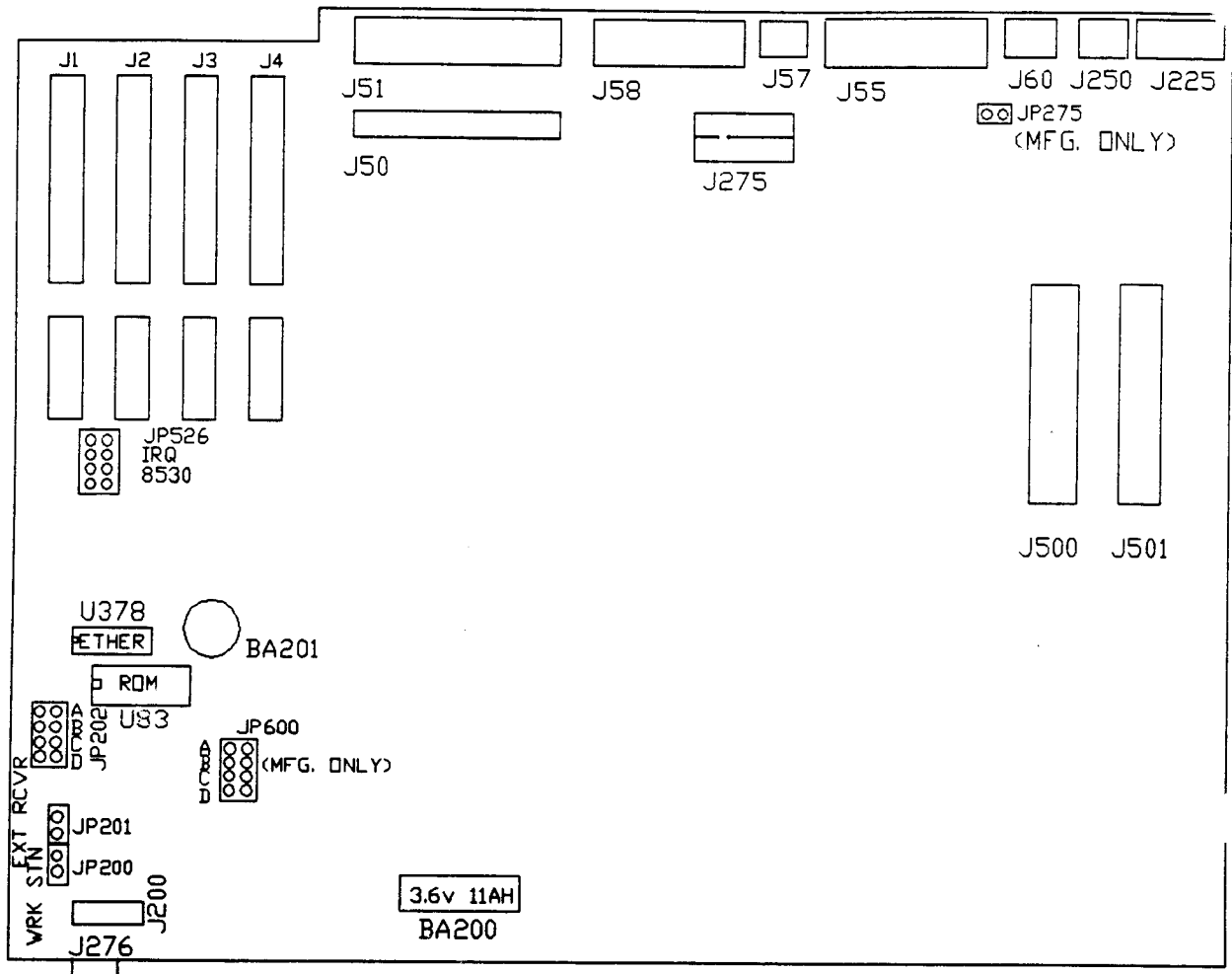

Figure 307. 3S/401 Main Unit Control Panel



3SERVER386

Figure 308. 3S/401 Main Logic Board

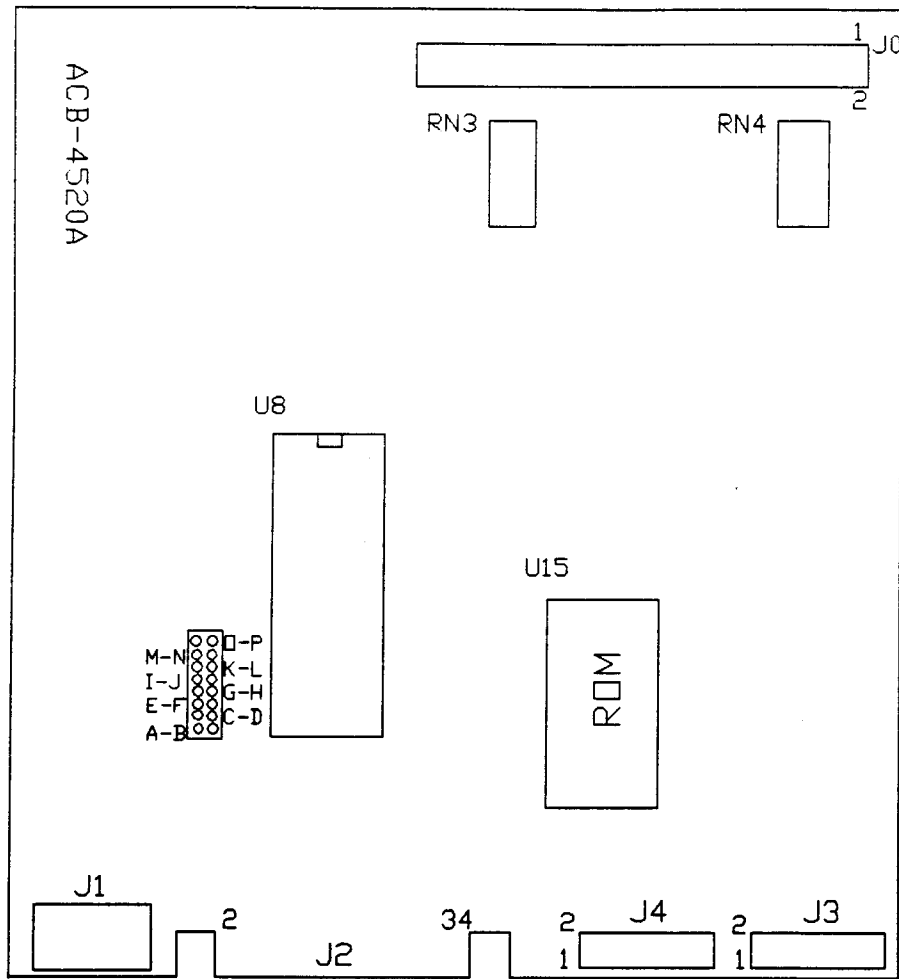

Figure 309. 3S/401 Hard/Tape Drive Controller Board

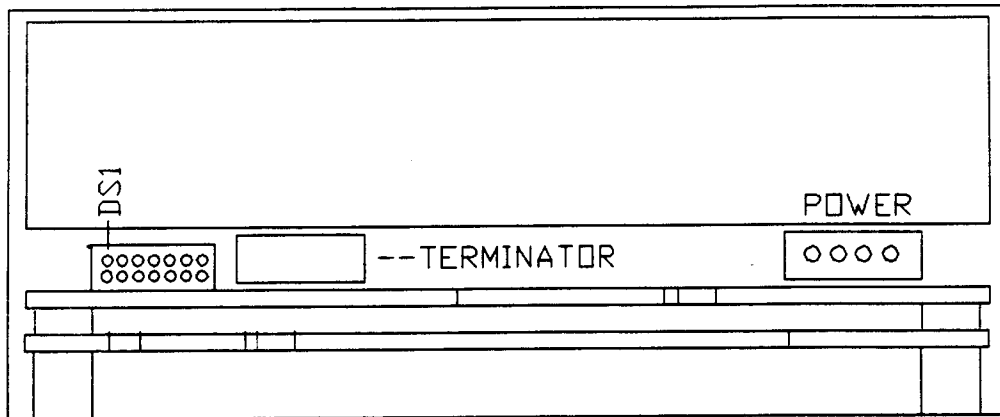

Figure 310. 3S/401 CDC Hard Drive

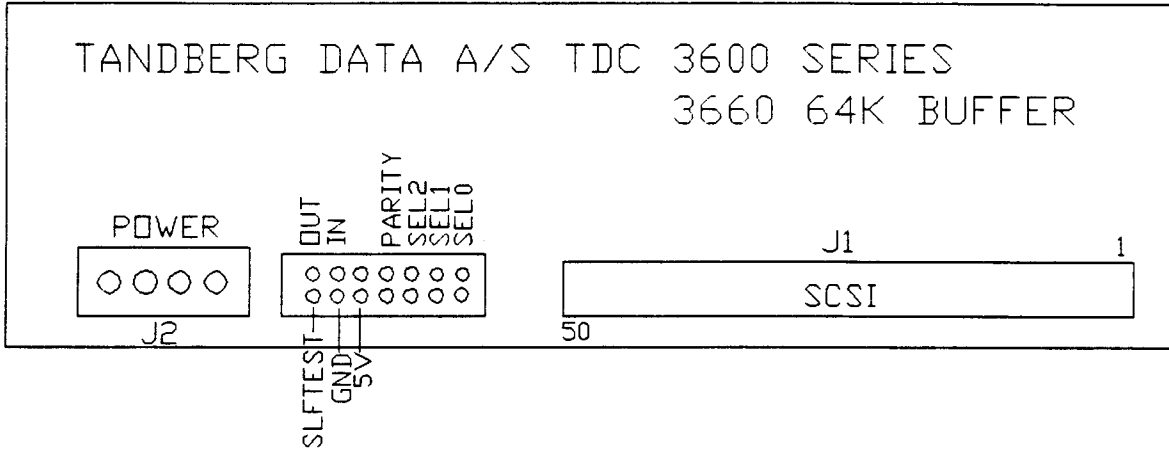
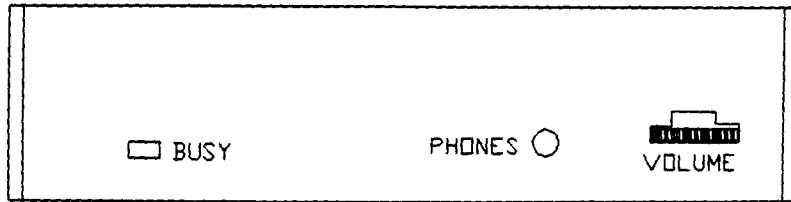
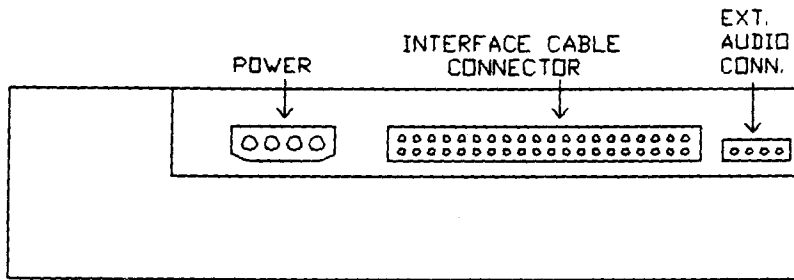

Figure 311. 3S/401 Tandberg Tape Drive

FRONT VIEW



REAR VIEW



CD-ROM Drive

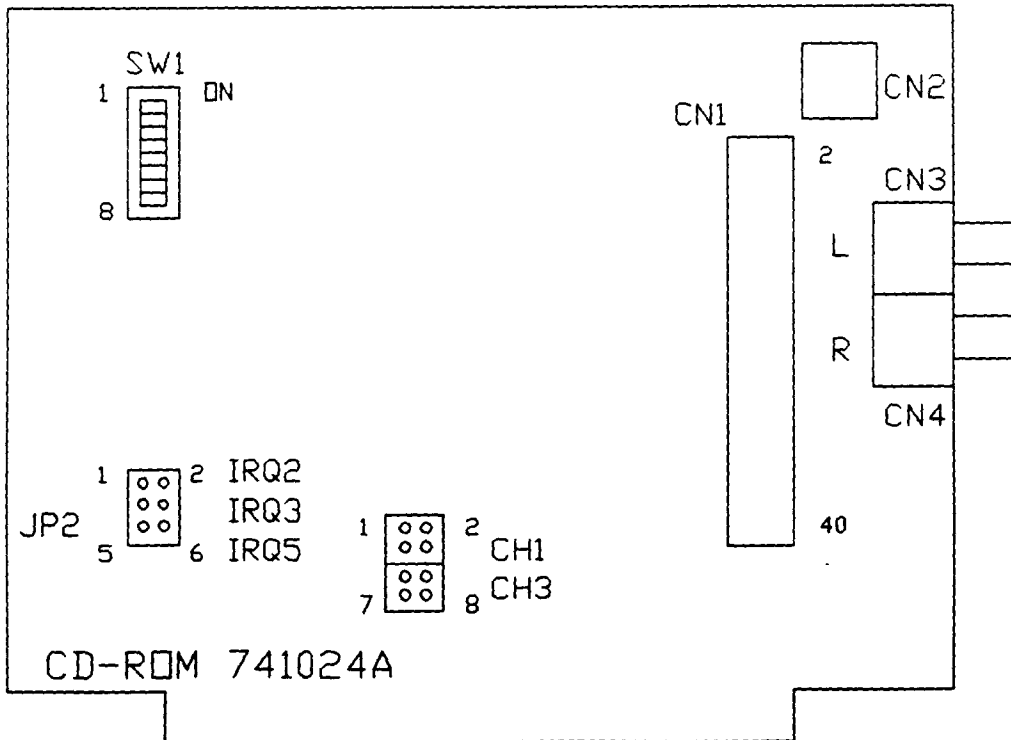

Interface Board

Figure 312. Mitsumi CDR-1000 CD-ROM Drive and Interface

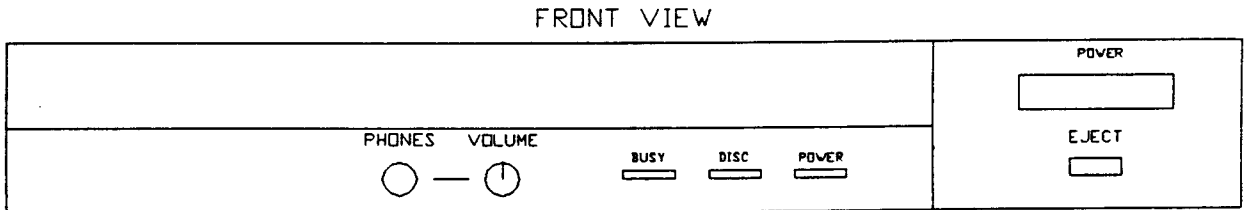
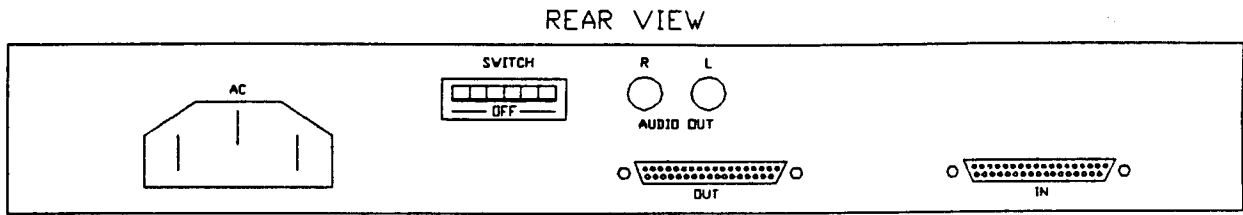

CD-ROM Drive

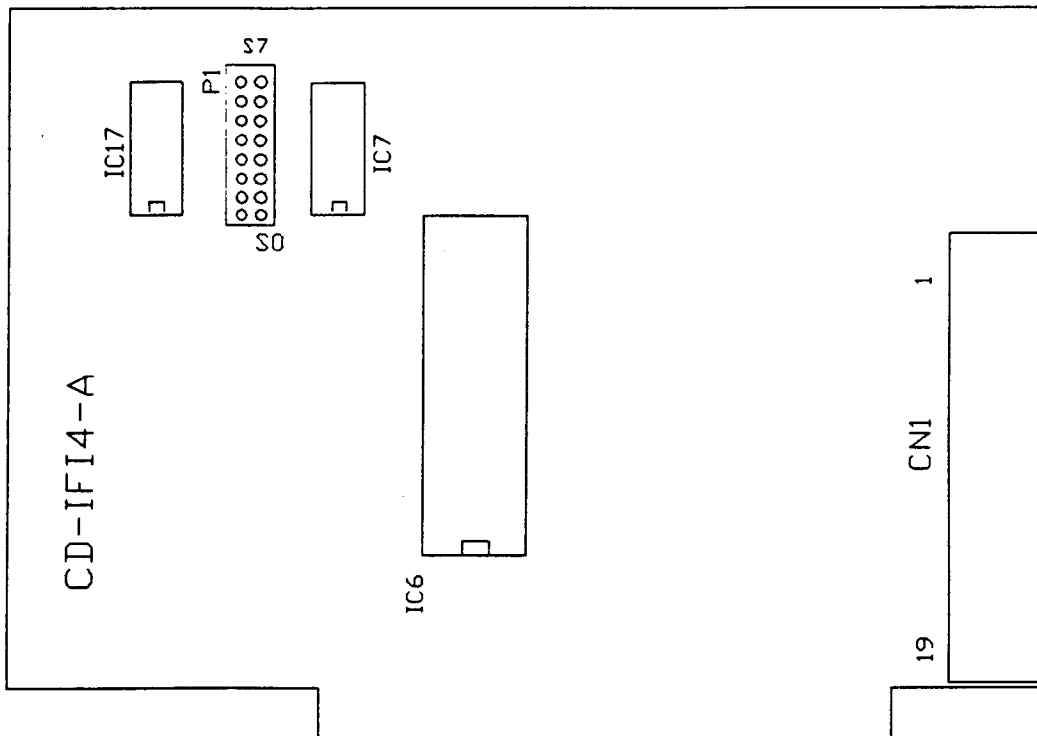

Interface Board

Figure 313. Hitachi External CD-ROM Drive 1700S (90-2156)
Hitachi External CD-ROM Drive Interface Board

REAR VIEW

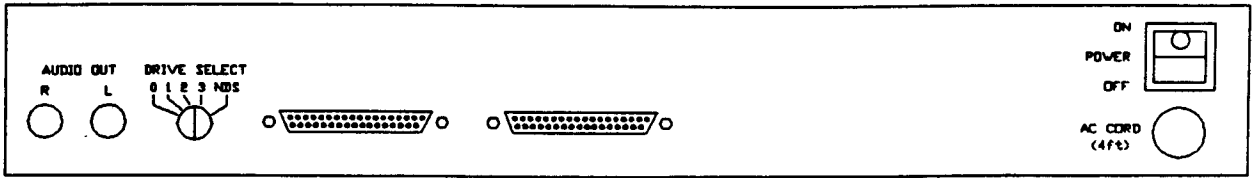

FRONT VIEW

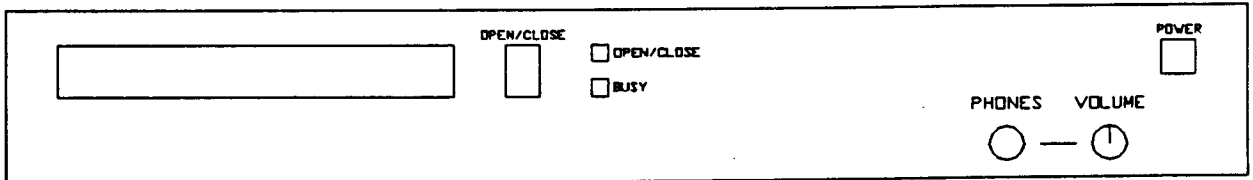

CD-ROM Drive

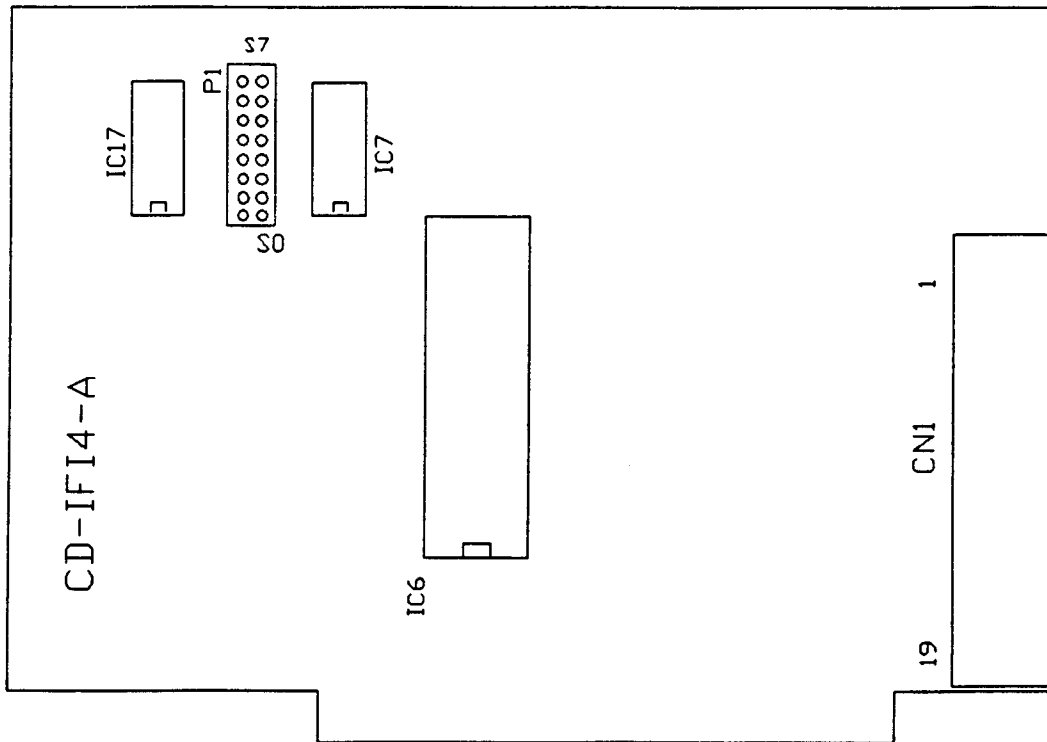

Interface Board

Figure 314. Hitachi External CD-ROM Drive 1503S (903-2376)
Hitachi External CD-ROM Drive Interface Board

SERVICE POLICY

Radio Shack's nationwide network of service facilities provides quick, convenient, and reliable repair services for all of its computer products, in most instances. Warranty service will be performed in accordance with Radio Shack's Limited Warranty. Non-warranty service will be provided at reasonable parts and labor costs.

RADIO SHACK
A Division of Tandy Corporation
Fort Worth, Texas 76102