

Radio Shack®

**● TRS-80®
Model 16B Built-in Hard Disk
SYSTEM MANUAL**

READ ME FIRST



TERMS AND CONDITIONS OF SALE AND LICENSE OF RADIO SHACK COMPUTER EQUIPMENT AND SOFTWARE PURCHASED FROM A RADIO SHACK COMPANY-OWNED COMPUTER CENTER, RETAIL STORE OR FROM A RADIO SHACK FRANCHISEE OR DEALER AT ITS AUTHORIZED LOCATION

LIMITED WARRANTY

I. CUSTOMER OBLIGATIONS

- A. CUSTOMER assumes full responsibility that this Radio Shack computer hardware purchased (the "Equipment"), and any copies of Radio Shack software included with the Equipment or licensed separately (the "Software"), meets the specifications, capacity, capabilities, versatility, and other requirements of CUSTOMER.
- B. CUSTOMER assumes full responsibility for the condition and effectiveness of the operating environment in which the Equipment and Software are to function, and for its installation.

II. RADIO SHACK LIMITED WARRANTIES AND CONDITIONS OF SALE

- A. For a period of ninety (90) calendar days from the date of the Radio Shack sales document received upon purchase of the Equipment, RADIO SHACK warrants to the original CUSTOMER that the Equipment and the medium upon which the Software is stored is free from manufacturing defects. THIS WARRANTY IS ONLY APPLICABLE TO PURCHASES OF RADIO SHACK EQUIPMENT BY THE ORIGINAL CUSTOMER FROM RADIO SHACK COMPANY-OWNED COMPUTER CENTERS, RETAIL STORES AND FROM RADIO SHACK FRANCHISEES AND DEALERS AT ITS AUTHORIZED LOCATION. The warranty is void if the Equipment's case or cabinet has been opened, or if the Equipment or Software has been subjected to improper or abnormal use. If a manufacturing defect is discovered during the stated warranty period, the defective Equipment must be returned to a Radio Shack Computer Center, a Radio Shack retail store, participating Radio Shack franchisee or Radio Shack dealer for repair, along with a copy of the sales document or lease agreement. The original CUSTOMER'S exclusive remedy in the event of a defect is limited to the correction of the defect by repair, replacement, or refund of the purchase price at RADIO SHACK'S election and sole expense. RADIO SHACK has no obligation to replace or repair expendable items.
- B. RADIO SHACK makes no warranty as to the design, capacity, capability, or suitability for use of the Software, except as provided in this paragraph. Software is licensed on an "AS IS" basis, without warranty. The original CUSTOMER'S exclusive remedy, in the event of a Software manufacturing defect, is its repair or replacement within thirty (30) calendar days of the date of the Radio Shack sales document received upon license of the Software. The defective Software shall be returned to a Radio Shack Computer Center, a Radio Shack retail store, participating Radio Shack franchisee or Radio Shack dealer along with the sales document.
- C. Except as provided herein, no employee, agent, franchisee, dealer or other person is authorized to give any warranties of any nature or behalf of RADIO SHACK.
- D. EXCEPT AS PROVIDED HEREIN, RADIO SHACK MAKES NO EXPRESS WARRANTIES, AND ANY IMPLIED WARRANTY OF MERCHANTABILITY OR FITNESS FOR A PARTICULAR PURPOSE IS LIMITED IN ITS DURATION TO THE DURATION OF THE WRITTEN LIMITED WARRANTIES SET FORTH HEREIN.
- E. Some states do not allow limitations on how long an implied warranty lasts, so the above limitation(s) may not apply to CUSTOMER.

III. LIMITATION OF LIABILITY

- A. EXCEPT AS PROVIDED HEREIN, RADIO SHACK SHALL HAVE NO LIABILITY OR RESPONSIBILITY TO CUSTOMER OR ANY OTHER PERSON OR ENTITY WITH RESPECT TO ANY LIABILITY, LOSS OR DAMAGE CAUSED OR ALLEGED TO BE CAUSED DIRECTLY OR INDIRECTLY BY "EQUIPMENT" OR "SOFTWARE" SOLD, LEASED, LICENSED OR FURNISHED BY RADIO SHACK, INCLUDING, BUT NOT LIMITED TO, ANY INTERRUPTION OF SERVICE, LOSS OF BUSINESS OR ANTICIPATORY PROFITS OR CONSEQUENTIAL DAMAGES RESULTING FROM THE USE OR OPERATION OF THE "EQUIPMENT" OR "SOFTWARE". IN NO EVENT SHALL RADIO SHACK BE LIABLE FOR LOSS OF PROFITS, OR ANY INDIRECT, SPECIAL, OR CONSEQUENTIAL DAMAGES ARISING OUT OF ANY BREACH OF THIS WARRANTY OR IN ANY MANNER ARISING OUT OF OR CONNECTED WITH THE SALE, LEASE, LICENSE, USE OR ANTICIPATED USE OF THE "EQUIPMENT" OR "SOFTWARE". NOTWITHSTANDING THE ABOVE LIMITATIONS AND WARRANTIES, RADIO SHACK'S LIABILITY HEREUNDER FOR DAMAGES INCURRED BY CUSTOMER OR OTHERS SHALL NOT EXCEED THE AMOUNT PAID BY CUSTOMER FOR THE PARTICULAR "EQUIPMENT" OR "SOFTWARE" INVOLVED.
- B. RADIO SHACK shall not be liable for any damages caused by delay in delivering or furnishing Equipment and/or Software.
- C. No action arising out of any claimed breach of this Warranty or transactions under this Warranty may be brought more than two (2) years after the date of action has accrued or more than four (4) years after the date of the Radio Shack sales document for the Equipment or Software, whichever first occurs.
- D. Some states do not allow the limitation or exclusion of incidental or consequential damages, so the above limitation(s) or exclusion(s) may not apply to CUSTOMER.

IV. RADIO SHACK SOFTWARE LICENSE

RADIO SHACK grants to CUSTOMER a non-exclusive, paid up license to use the RADIO SHACK Software on one computer, subject to the following provisions:

- A. Except as otherwise provided in this Software License, applicable copyright laws shall apply to the Software.
- B. Title to the medium on which the Software is recorded (cassette and/or diskette) or stored (ROM) is transferred to CUSTOMER, but not title to the Software.
- C. CUSTOMER may use Software on one host computer and access that Software through one or more terminals if the Software permits this function.
- D. CUSTOMER shall not use, make, manufacture, or reproduce copies of Software except for use on one computer and as is specifically provided in this Software License. Customer is expressly prohibited from reassembling the Software.
- E. CUSTOMER is permitted to make additional copies of the Software only for backup or archival purposes or if additional copies are required in the operation of one computer with the Software, but only to the extent the Software allows a backup copy to be made. However, for MS-DOS Software, CUSTOMER is permitted to make a limited number of additional copies for CUSTOMER'S own use.
- F. CUSTOMER may sell or distribute unmodified copies of the Software provided CUSTOMER has purchased one copy of the Software for each one sold or distributed. The provisions of this Software License shall also be applicable to third parties receiving copies of the Software from CUSTOMER.
- G. All copyright notices shall be retained on all copies of the Software.

V. APPLICABILITY OF WARRANTY

- A. The terms and conditions of this Warranty are applicable as between RADIO SHACK and CUSTOMER to either a sale of the Equipment and/or Software License to CUSTOMER or to a transaction whereby RADIO SHACK sells or conveys such Equipment to a third party for lease to CUSTOMER.
- B. The limitations of liability and Warranty provisions herein shall inure to the benefit of RADIO SHACK, the author, owner and/or licensor of the Software and any manufacturer of the Equipment sold by RADIO SHACK.

VI. STATE LAW RIGHTS

The warranties granted herein give the original CUSTOMER specific legal rights, and the original CUSTOMER may have other rights which vary from state to state.

The FCC wants you to know . . .

Warning: This equipment generates used and can radiate radio frequency energy and if not installed and used in strict accordance with the instructions manual, may cause interference to radio communications. It has been tested and has been found to comply with the limits for a Class A computing device pursuant to Subpart J of Part 15 of FCC Rules, which are designed to provide reasonable protection against such interference when operated in a commercial environment. Operation of this equipment in a residential area is likely to cause interference in which case the user at his own expense will be required to take whatever measures may be required to correct the interference.

**TRS-XENIX Operating System:
Copyright 1982 Microsoft.**

All Rights Reserved. Licensed to Tandy Corporation.

**TRSDOS 2.0b Operating System:
Copyright 1980 Tandy Corporation.
All Rights Reserved.**

**TRSDOS-II Operating System:
Copyright 1982 Tandy Corporation.
All Rights Reserved.**

**BASIC Software:
Copyright 1980 Microsoft.
All Rights Reserved.
Licensed to Tandy Corporation.**

**TRS-80 15-Meg Built-In Hard Disk System — Read Me
First Manual:
Copyright 1983 Tandy Corporation.
All Rights Reserved.**

Reproduction or use, without express written permission from Tandy Corporation, of any portion of this manual is prohibited. While reasonable efforts have been taken in the preparation of this manual to assure its accuracy, Tandy Corporation assumes no liability resulting from any errors or omissions in this manual, or from the use of the information obtained herein.

INTRODUCTION

About Your System

Congratulations on your purchase of the TRS-80® 15-Meg Built-in Hard Disk System. This is a computer system with a built-in mass storage device. You'll find it to be a valuable tool which gives you more information storage and faster data retrieval than ever before with a TRS-80 System. And with Radio Shack's large selection of peripherals you can expand your system to include printers, a second hard disk, graphics options, and more.

The Hard Disk System special features include:

- Maximum storage capacity of 15 megabytes (per drive).
- 5-Mbits/second data transfer rate which is at least 10 times faster than floppy diskettes.
- Environmentally sealed head and disk chamber for safer data storage and longer disk life.
- An enhanced floppy diskette data storage format that lets you store more information on an 8" diskette than ever before.

About This Manual

This manual contains the information you need to get started. It explains the various parts of your system, the different types of disks, and how to install your system. It also shows how to operate the System, load a program, and use some of the more helpful commands. In addition, it also explains some terms you need to know.

Since this is a "getting-started" manual, it does not describe all the optional features available with each command. For complete information on each command, refer to the programming manuals.

Notational Conventions

The following conventions are used to show syntax in this manual:

CAPITALS

Any words or characters which are uppercase must be typed in exactly as they appear.

lowercase italics

Fields shown in lower case italics are variable information that you must substitute a value for.

KEYBOARD

Any word or character contained within a box represents a keyboard key to be pressed.

...

Ellipses indicate that a field entry may be repeated.

filespec

A field shown as a filespec indicates a standard TRSDOS file specification of the form: *filename/ext,password:d(disk name)* **Note that with the Built-in Hard Disk System, d (Drive) can be any number between 0-7.**

punctuation

Punctuation other than ellipses must be entered as shown.

delimiters

Commands must be separated from their operands by one or more blank spaces. Multiple operands, where allowed, may be separated from each other by a comma, a comma followed by one or more blanks, or by one or more blanks. Blanks and commas may not appear within an operand.

TABLE OF CONTENTS

Section I/ Installation and Power Up

1/	Installing your Built-in Hard Disk System.....	5
	Your Equipment	6
	Installing Your System.....	9
	Installing Peripheral Equipment	10
2/	About Disks and Programs	13
	Types of Disks	13
	Disk Format and Files.....	15
	Operating Systems and Application Programs	15
3/	Power-Up/Power-Down.....	17
	Powering Up the System	17
	Powering Down.....	20
	Error Messages.....	20

Section II/ Hard Disk Control

4/	Hard Disk System Preparation/TRS-XENIX.....	21
5/	Hard Disk System Preparation/TRSDOS-II	23
	Preparing Your Primary Hard Disk.....	23
	Preparing Your Secondary Hard Disk.....	24
	Preparing TRSDOS Application Programs	26
	Copying TRSDOS-II Programs onto a Hard Disk	26
	Creating a Backup Library.....	26
	Running TRSDOS-II Programs Under Hard Disk Control.....	26

Section III/ Floppy Diskette Preparation

6/	Backing Up TRSDOS-II and TRSDOS 2.0b.....	27
	Backing Up Your TRSDOS-II Systems Diskette	27
	Backing Up Your Thinline TRSDOS 2.0b Diskette	28
	Tips on Safeguarding Data	30
7/	Using TRSDOS Programs	31
	Preparing TRSDOS Programs.....	31
	Removing and Swapping Diskettes.....	33
	Formatting Diskettes.....	33
8/	Sample Session.....	35

Section IV/ Maintenance and Appendices

9/	Maintenance	37
	Care of Floppy Diskettes.....	37
	Floppy Diskette Drive Maintenance	38
	Secondary Hard Disk Drive Maintenance	38

Appendices

A /	Problems and Error Messages	39
B /	The BACKUP and SAVE/RESTORE Utilities	47
C /	Graphics Codes.....	59
D /	Specifications.....	60
E /	Quick Reference Chart.....	67
F /	Keyboard Code Map	68



**SECTION I/
INSTALLATION
AND POWER-UP**



CHAPTER 1: INSTALLING YOUR BUILT-IN HARD DISK SYSTEM

This chapter shows you how to install your Built-in Hard Disk System.

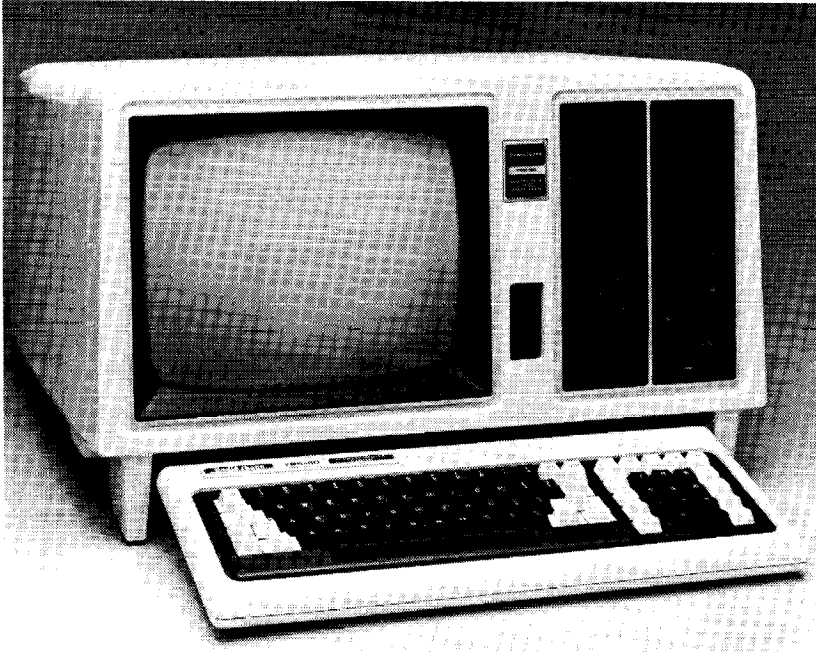

Built-in Hard Disk System Console and Keyboard.

Your Equipment

Carefully unpack the Built-in Hard Disk system and make sure you have the following items:

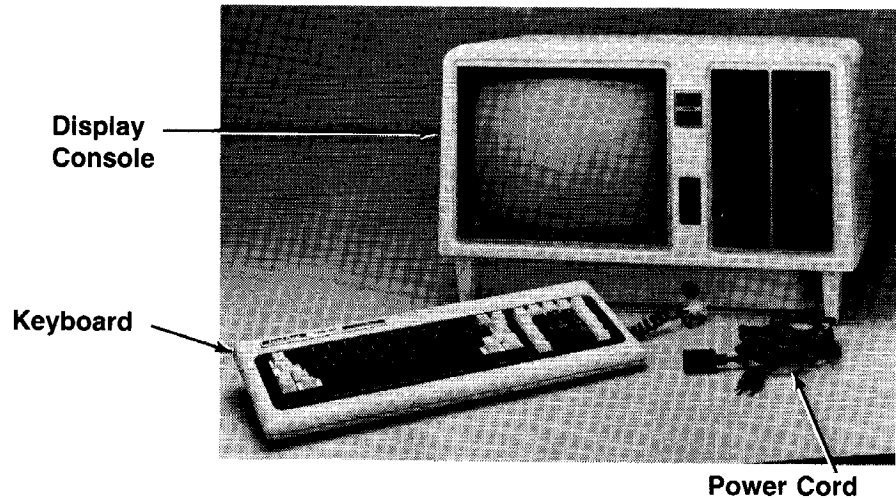

You should also have these programming manuals:

- *TRS-XENIX Operations Guide*
- *TRSDOS-II Reference Manual* (includes addendum)
- *BASIC Reference Manual*

On all hard disk units, flaws in the media are identified before the disk drives are delivered to you. Attached to the inside the access panel on the back of your display console or the bottom of your Secondary Hard Disk Unit (if you have one) is a DISK FLAW RECORD which specifies the errors on your particular unit. **Do not throw this map away!** You may need to refer to it when formatting the disk and Radio Shack service technicians may need to refer to it if your drive ever needs servicing.

At the front of your manuals, you'll find these floppy diskettes:

- TRS-XENIX Systems Diskettes (3)
- TRSDOS-II Systems Diskette with BASIC Interpreter
- Thinline TRSDOS 2.0b Diskette with BASIC Interpreter

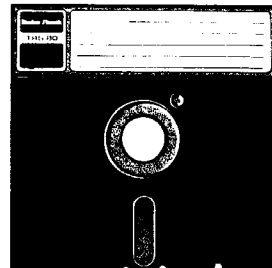

(Chapter 2 explains how to prepare diskettes for information storage. Diskettes must be handled carefully, so read Chapter 2 before you use your diskettes.)

Note: Your system may also include an optional secondary stand-alone hard disk drive unit (Drive 5) and/or a floppy diskette expansion unit with up to two drives (Drives 2 and 3). These units are optional extras.

Save the packing materials in case you need to transport your system.

About Your Equipment

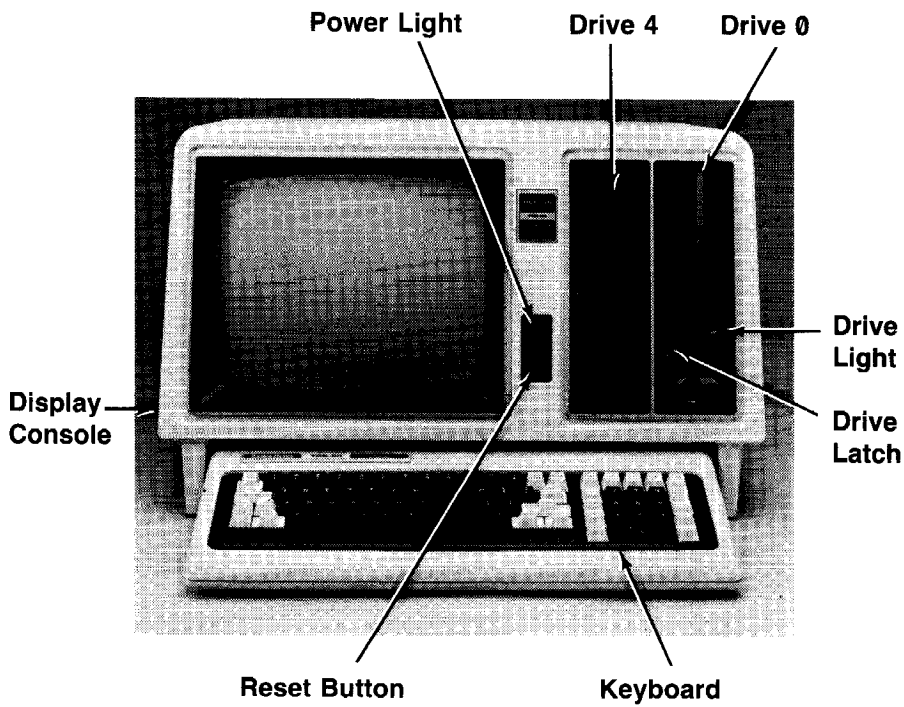

Reset Button — Repeats the power-up sequence.

Power Light — Lighted when the system's power is on. Never move the unit while lit.

Drive Light — Never remove a diskette when the drive light is on.

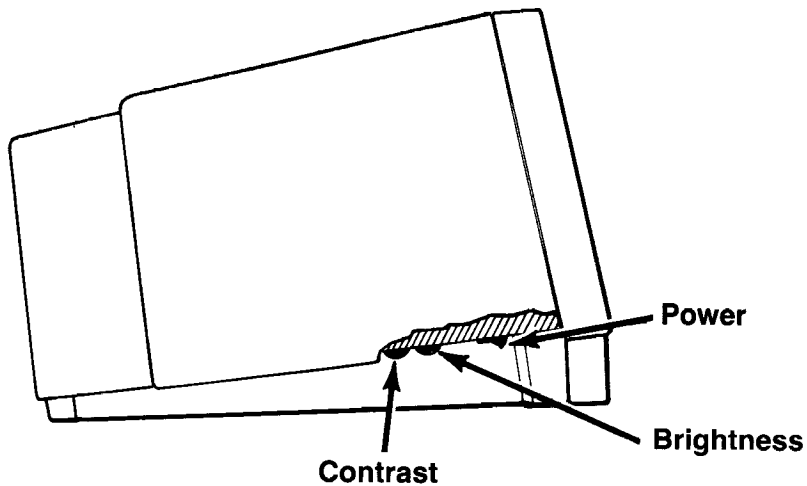

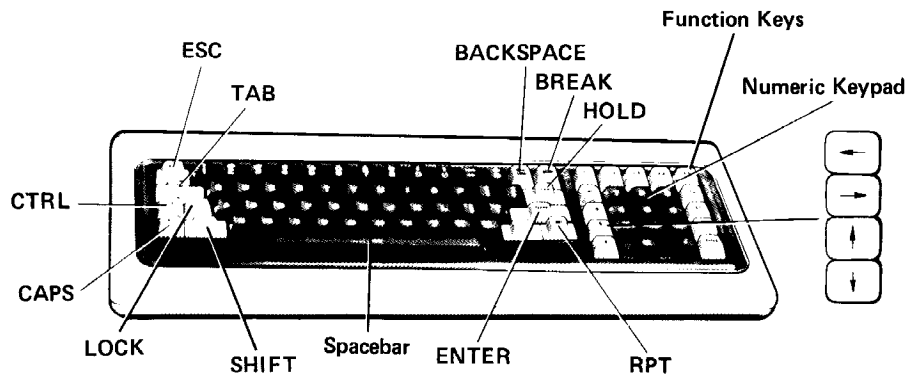

(CAPS) — When the **(CAPS)** light is on, **(CAPS)** sends only capital-letter codes for the alphabet keys. It does not affect other keys. Press **(CAPS)** once to turn the caps-only mode off or on.

(SHIFT), **(LOCK)** — Lets you input capital letters and shift punctuation symbols. Hold down **(SHIFT)** while pressing the desired key or press the **(LOCK)** once (the red light comes on). When the **(LOCK)** light is on, only shifted characters are output. To release **(LOCK)**, press **(SHIFT)**.

Numeric Keypad — These keys are not affected by **(SHIFT)**, **(LOCK)**, or **(CAPS)**.

(RPT) — Repeats a character continuously when held down at the same time as another key.

To determine the uses of other keys, see your program manual.

Optional Equipment

If you have peripheral equipment, such as an optional stand-alone secondary hard disk or printer, follow the instructions in "Installing Peripheral Equipment" and the manual(s) supplied with the equipment. Visit your Radio Shack Computer Center to learn about the other equipment you can use with your Built-in Hard Disk System.

Installing Your System

Improperly Connecting or grounding the System exposes you to the danger of electrical shock. It also endangers your System and data. Follow these installation instructions carefully.

1. Place your Built-in Hard Disk System near a grounded, 120 VAC, 3-prong outlet that does not power heavy machinery, copiers, or office machines with defective switches. (or use a grounded power strip such as Radio Shack's Plug-In Power Strip.)
2. Make sure all equipment is turned off.
3. Connect the keyboard's built-in cable to the display console.

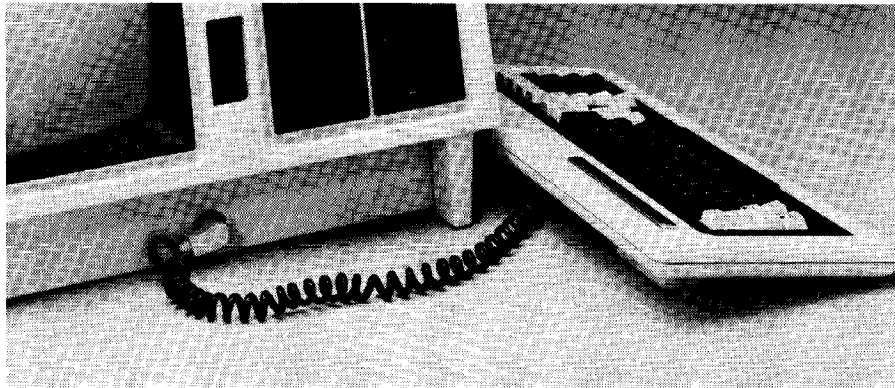

4. Plug the power cord into the back of the display console.
5. Plug the power cord directly into the outlet or grounded power strip specified in Step 1.

Installing Peripheral Equipment

You can use other Radio Shack equipment (such as a printer, a secondary hard disk or a floppy diskette expansion unit) with your Built-in Hard Disk System. To install such equipment, refer to the following instructions and the manual(s) supplied with the equipment.

Externally Connected Peripheral Equipment

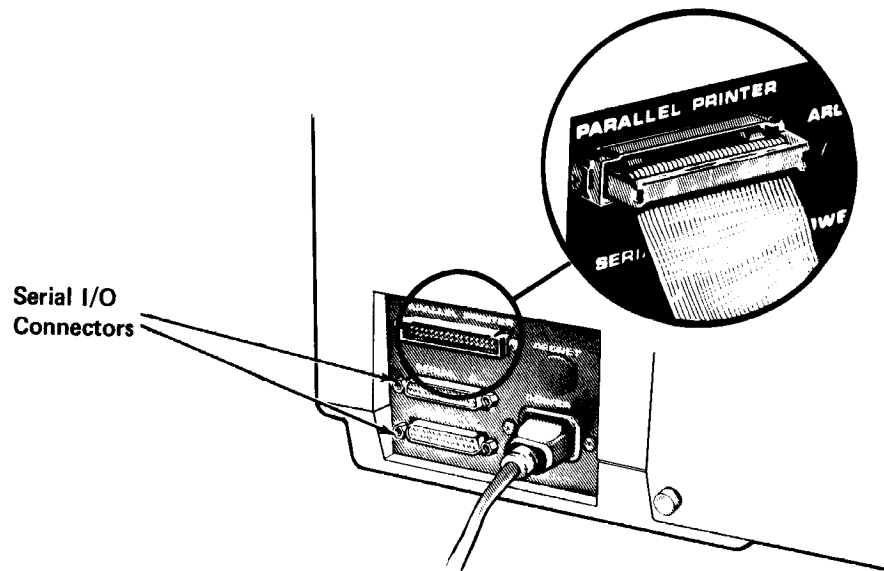

External Peripheral Equipment Connections.

Parallel Printer Connector — Used to connect Radio Shack parallel printers. Make sure the printer cable exits the bottom of the connector.

Serial I/O Connector — Used to install serial equipment such as serial line printers, modems, and data terminals. When connecting a DB-25 type cable, fit the cable connector to your Built-in Hard Disk System's connector.

Internally Connected Peripheral Equipment

The floppy diskette and hard disk expansion connectors are behind the Input/Output Access Panel on the back of your Built-in Hard Disk System.

Floppy Diskette Expansion Connector — Used to add floppy diskette storage devices, such as the Thinline Disk Bay. Instructions for connecting the cable are on the next page.

Hard Disk Expansion Connectors — Used to add an optional secondary hard disk. Your system has these connectors only if the system has a built-in hard disk. Instructions for connecting the cables are on the next page.

The illustration on the next page shows the floppy and hard disk expansion connectors with cables attached.

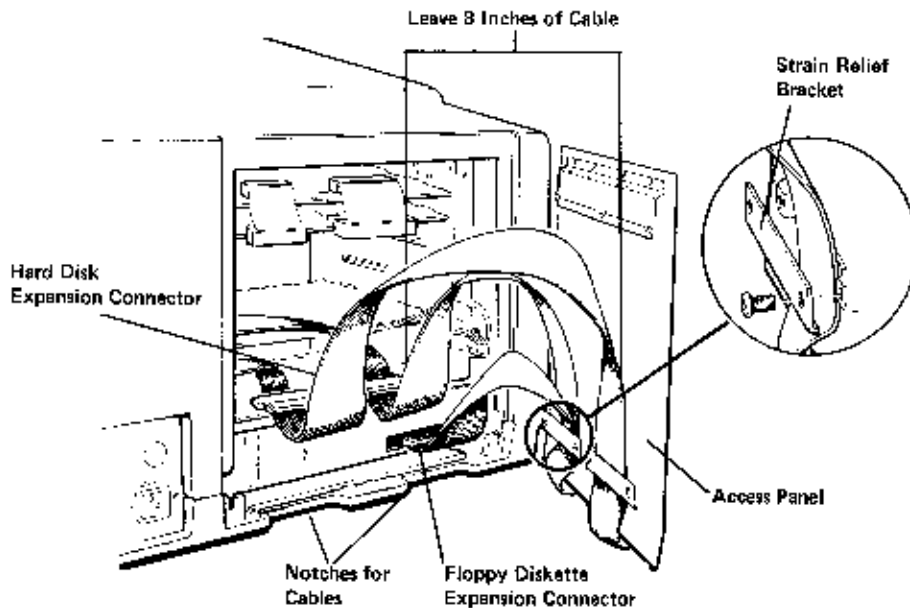

1. Remove the access panel by loosening the thumbscrews.
2. Attach the cables that are included with your expansion unit to the appropriate connector. Connect the 34-pin Secondary Hard Disk Expansion Cable Connector to the 34-pin snap-in connector on the edge of the P.C. board. Also connect the 20-pin Data Cable Connector to the 20-pin snap-in connector on the edge of the P.C. board.

If you are connecting a Floppy Disk Expansion Unit attach the connector on one end of the cable to the 50-pin connector on the chassis. Connect the other end of the cable to the Expansion Unit.

Position all the Built-in Hard Disk internal connectors so that the cables exit from the bottom.

3. Remove the strain relief brackets from the access panel. Run the cables downward through the "strain reliefs" nearest to the cables, leaving about 8 inches of cable between the strain relief and the computer.
4. Replace the strain relief brackets and run the cables through the notch in the computer base.
5. Replace the access panel and tighten the thumbscrews.

Also, the Hard Disk Drives in your System must always contain a Line Terminator. Check with your Radio Shack Computer Center for details.



CHAPTER 2: ABOUT DISKS AND PROGRAMS

Computers can store information in two ways:

- Temporarily, in memory (turning the computer off erases memory)
- Permanently, in a storage device

Disks are one of the best storage devices available because of the way the system can organize and index information on them.

Types of Disks

Your Built-in Hard Disk System can use two types of disks:

- Floppy diskettes — Your Built-in Hard Disk System has one built-in floppy drive (Drive 0) and other peripheral floppy diskette drives can be added.
- Hard disks — Your Built-in Hard Disk System has one built-in hard disk drive (Drive 4) and another peripheral secondary hard disk drive can be added (Drive 5).

Floppy Diskettes

Floppy diskettes are convenient and inexpensive. The term "floppy" means the diskette bends if mishandled. Care of floppy diskettes is discussed later in this manual.

There are two types of floppy diskettes you can use with your Built-in Hard Disk System:

- *Single-sided diskettes* can store around 500,000 bytes of information.
- *Double-sided diskettes* can store twice as much information because they use both sides.

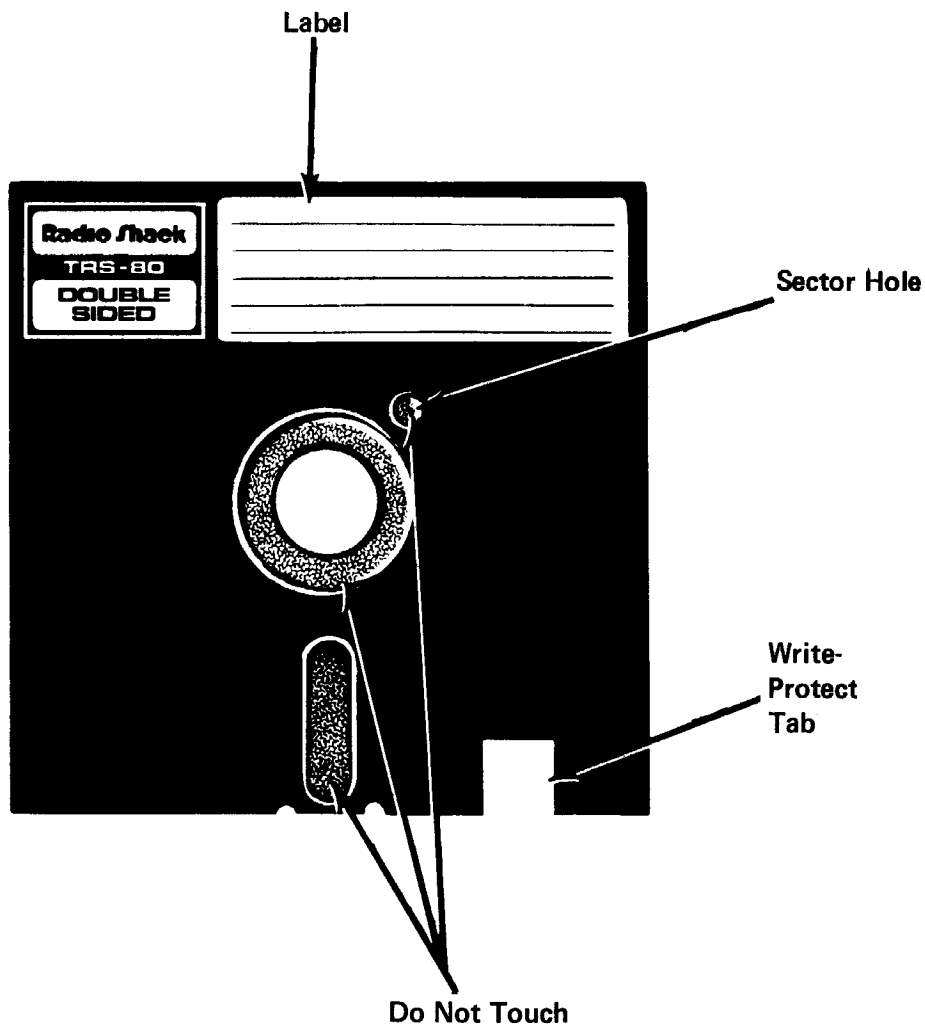

Label — After placing a label on a diskette, write on it with a felt-tip pen only. (Currently, Radio Shack diskettes are labeled as single- or double-sided. If a diskette is not labeled, it is an older, single-sided diskette.)

Write-Protect Tab — To change information on a diskette, you must write enable the diskette. Do this by covering the write-protect notch with one of the gummed-foil tabs provided. You cannot change a diskette's information if the write-protect notch is uncovered.

Sector Hole — It is off-center on double-sided diskettes.

Keep diskettes away from dirt, pressure, magnetic fields, and excessive heat and sunlight. Do not bend them. (See Chapter 9, "Maintenance.")

Hard Disks

Unlike floppy diskettes, hard disks cannot be removed from their drives. Hard disks are sturdier, faster, and store more bytes of information.

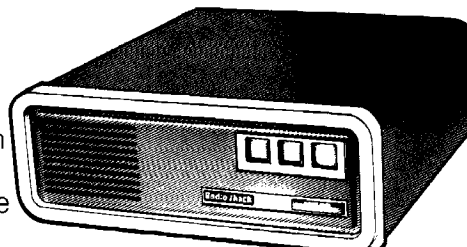

External Drive

Disk Format and Files

You can store programs and then easily retrieve and run them because of the efficient way your operating system organizes information on disks. The two parts of disk organization are:

- Disk Format
- Disk Files

Formatting prepares disks for information storage. It divides disks into the parts of a "filing" system: cylinders, tracks, sectors, and bytes. It also creates a directory on each disk.

You can store information on formatted disks only. Any disk that contains an application program or operating system is already formatted.

The blank diskettes you buy in a Radio Shack Computer Center are not formatted. To format a data diskette, follow the steps under "Formatting Disks" in Chapter 7, "Floppy Diskette System Preparation."

Disk Files are similar to the files in a file cabinet. They can contain whatever you put in them: programs, data, information, and each file has a different name. Disk files usually are created through an application program.

Operating Systems and Application Programs

Operating systems are programs that enable you to operate a computer. They let you manipulate and store data, control peripherals, and use application programs.

Application programs help you perform tasks such as bookkeeping, word processing, and program development.

Operating Systems

Your system comes with three operating systems:

- TRS-XENIX
- TRSDOS-II
- TRSDOS 2.0b

All application programs must be run with one of these operating systems in Drive 0 or on Drive 4. To determine which operating system your application program uses, check:

- Application manual
- Diskette label. The label identifies a TRS-XENIX, TRSDOS-II, or TRSDOS application program. If a system is not given, you have a TRSDOS application.

To learn more about your operating systems, see the appropriate manual:

TRS-XENIX *Operations Guide*

TRSDOS-II and TRSDOS — *TRSDOS-II Reference Manual*

Application Programs

Your system comes with one application program, BASIC.

BASIC is a TRSDOS-II/TRSDOS program (it runs under TRSDOS and TRSDOS-II). This application program lets you write programs in BASIC (Beginners' All-Purpose Symbolic Instruction Code).

To learn more about your applications programs, see the appropriate manual:

BASIC — *BASIC Reference Manual*

CHAPTER 3: POWER-UP/POWER-DOWN

Always turn your Built-in Hard Disk System on and off exactly as described in this chapter. Any change in the sequences might damage the system and data.

You can use your Built-in Hard Disk System in two ways: under hard disk control or under floppy diskette control. Because hard disk operation is more efficient, you'll probably operate under hard disk control most of the time.

Until you have prepared your hard disk (Chapter 4 or 5), you must operate under floppy diskette control.

Powering Up the System

1. Make sure all diskette drives are empty and all equipment is off.
2. Turn on the System by pushing the power switch forward. Built-in Hard Disk Drive 4, Floppy Disk Drive 0 and the Secondary Hard Disk Drive if present, will be turned on automatically. Allow 1 minute warm-up for the hard disk drives.
3. Turn on any other peripheral equipment.

Hard Disk Control

After you have initialized your hard disk by storing your operating system on it, the system will go to Drive 4 first, and automatically load the operating system. You can then begin using your system.

Floppy Diskette Control

To operate under floppy diskette control press **(RPT) (BREAK)** during the "white-out" of the video display. The message INSERT DISKETTE is displayed to indicate that you are operating under floppy diskette control.

If INSERT DISKETTE is not displayed or the hard disk operating system does not load:

- Press the reset button.
- Then press **(RPT) (BREAK)**.
- Adjust the brightness and contrast controls.
- Turn off all peripherals and then turn off the System and check all connections.
- See Appendix A, "Error Messages."

When INSERT DISKETTE is displayed, turn on any peripheral equipment.

Inserting a Floppy Diskette

1. Power up your Built-in Hard Disk System and press **(RPT)** **(BREAK)**. The "INSERT DISKETTE" message will be displayed.
2. Make sure the drive latch is in the vertical position.

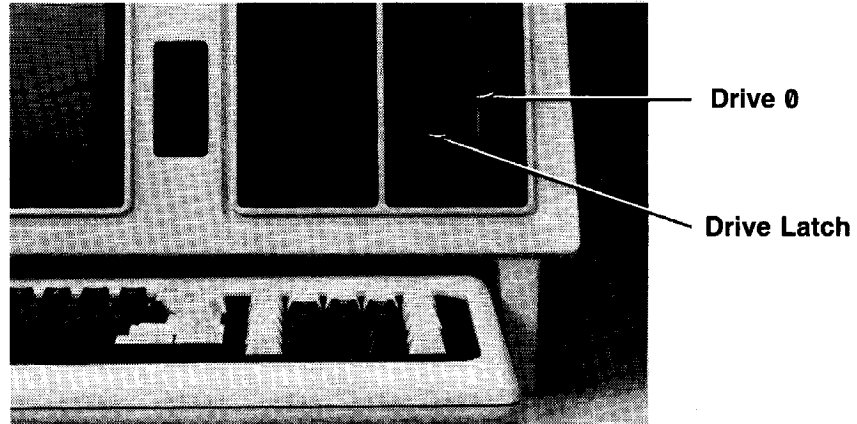

3. Carefully insert the TRSDOS-II operating system diskette into Drive 0, with the label facing the display. Push the diskette into the slot until it locks into place.

NOTE: To make a Backup of the supplied TRSDOS 2.0b and TRSDOS-II Diskettes see Chapter 6.

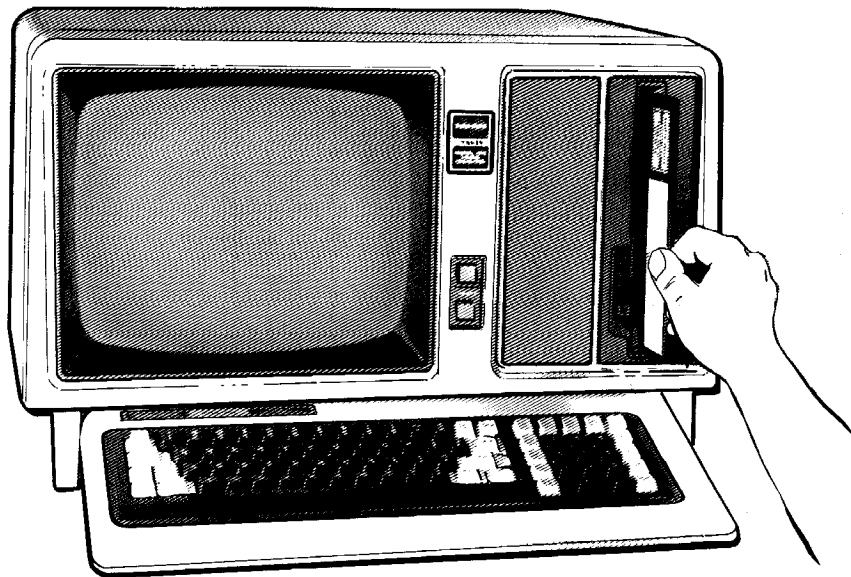

4. Rotate the drive latch clockwise until it locks into a horizontal position. After a few seconds, the start-up message, which is shown below, appears on the display.

Note: Never turn the System on or off when a diskette is in a drive. Doing so can destroy your data.

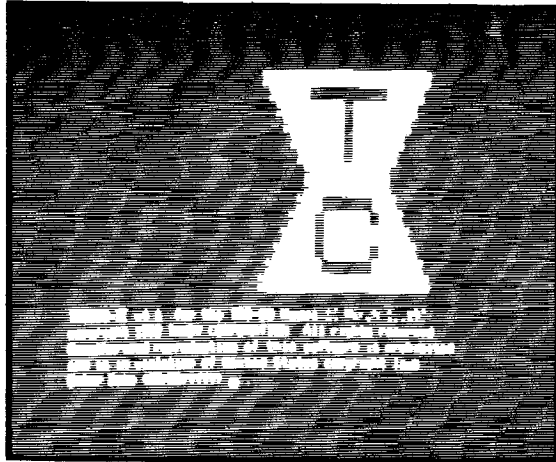

Enter the date in the format displayed on your screen. For example, for September 1, 1983, type:

09/01/1983 **(ENTER)**

To skip the ENTER TIME prompt now on your screen, press **(ENTER)**. This starts the time at 00.00.00. Or, enter the time in the displayed, 24-hour format (seconds are optional). For example, 2:30 p.m., type:

14.30 **(ENTER)**

Your screen shows:

TRSDOS-II Ready
.....

This message indicates that TRSDOS-II is ready to accept a command or load an application program.

If, instead of the above start-up message:

- An error message is displayed, see Appendix A, "Error Messages."
- The message NOT A SYSTEM DISKETTE is displayed, remove the diskette. Correctly insert an operating system diskette into Drive 0. Press the reset button.
- No message is displayed within 30 seconds, you probably inserted the diskette incorrectly. Remove it and go back to Step 2.

Removing a Floppy Diskette

1. Make sure the drive light is off.

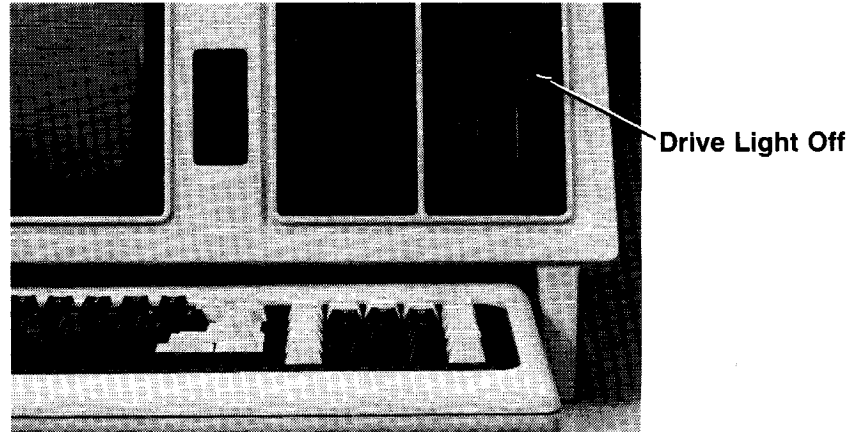

2. Rotate the drive latch counterclockwise until it is in the vertical position. The diskette pops partially out of the drive.
3. Carefully remove the diskette from the drive, making sure its shiny surface does not touch anything. Put it back into its storage envelope.

Powering Down the System

1. Make sure all the floppy drives are empty.
2. Turn off all peripheral equipment (Secondary Hard Disk Drive will be turned off with the System).
3. Turn off the system by pushing the power switch back.

Error Messages

Whenever you type a command incorrectly or try to use it in the wrong way, the Built-in Hard Disk System notifies you with an error message. If the error occurred simply because you mistyped the command, try typing it again.

If you still get the error, refer to Appendix A, "Problems and Error Messages." It contains a description of the causes and appropriate action for each error.

SECTION II/ HARD DISK CONTROL

To use your hard disk, you must first prepare it. How you do this depends on what programs you will run under hard disk control.

- TRS-XENIX programs — Programs that run under the TRS-XENIX, multi-user operating system. (Multi-user means that more than one person can use the operating system at the same time.)
- TRSDOS-II or TRSDOS programs — Programs that run under the TRSDOS-II or TRSDOS, single-user operating system.

You cannot run both TRS-XENIX and TRSDOS-II/TRSDOS programs under the same operating system. You must select one operating system or the other!

Customers with TRS-XENIX programs: Prepare your primary hard disk for TRS-XENIX programs (Chapter 4).

Customers with TRSDOS-II/TRSDOS programs: Prepare your primary hard disk for TRSDOS-II/TRSDOS programs (Chapter 5).

Customers with both TRS-XENIX programs and TRSDOS-II/TRSDOS programs: most TRS-XENIX programs will run only under hard disk control, whereas TRSDOS-II/TRSDOS programs will run under both hard disk control and floppy diskette control. (Exceptions are a few hard disk TRSDOS-II programs that will run only under hard disk control.)

We recommend you prepare your primary hard disk for TRS-XENIX programs (Chapter 4). Then, run your TRSDOS-II/TRSDOS programs under floppy diskette Control (Chapter 7).



CHAPTER 4: HARD DISK SYSTEM PREPARATION/TRS-XENIX

Your TRS-XENIX Operations Guide describes the features and concepts of TRS-XENIX. It also explains in detail how to start up TRS-XENIX on your hard disk system.

This chapter summarizes what you need to do to get started. It also tells you where to look in the TRS-XENIX Operations Guide for specific instructions.

If you have decided to prepare your hard disk for TRSDOS-II/TRSDOS programs, skip this chapter.

Preparing Your Primary Hard Disk

If you have used your hard disks before, be sure to save any important files to floppy diskettes before installing TRS-XENIX. A page at the front of the TRS-XENIX Operations Guide titled "IMPORTANT" describes how to do this.

To begin using TRS-XENIX, you must format the primary hard disk using the **diskutil** program. This program automatically starts the TRS-XENIX installation procedure which moves the operating system to the hard disk. Directions for formatting the hard disk and installing TRS-XENIX are given in Chapter 3 of the TRS-XENIX Operations Guide.

Note: The **diskutil** program will prompt you for this information. Your 15-meg hard disk has 6 heads and 306 cylinders.

Preparing Your Secondary Hard Disk

Read Chapter 10 of the TRS-XENIX Operations Guide for instructions on using the Secondary Hard Disk with TRS-XENIX.

Note: This disk cannot be write protected by use of the write protect switch.

Transferring TRSDOS-II Files to TRS-XENIX

You can transfer TRSDOS-II 4.x files to TRS-XENIX using the TRS-XENIX **tx** command. Files stored on TRSDOS 2.x must be FCOPYed to TRSDOS-II 4.x before they can be transferred. Appendix E of the TRS-XENIX Operations Guide explains how to transfer files to TRS-XENIX.

Creating Backups

Through operator error, power failure or other accidents, you can lose information stored on hard disk. To prevent the loss of a day's, week's, or even month's work, keep up-to-date copies of all the files that are on your hard disk. Chapter 7 of the TRS-XENIX Operations Guide describes the backup procedure.



CHAPTER 5: HARD DISK SYSTEM PREPARATION/TRSDOS-II

Preparing Your Primary Hard Disk (Drive 4)

This chapter shows how to prepare your hard disk for TRSDOS-II/TRSDOS programs. If you have prepared your hard disk for TRS-XENIX programs, skip this chapter.

Copy Your Hard Disk Files

If you have stored information on a hard disk, use the SAVE or MOVE command (see your *TRSDOS-II Reference Manual*) to make copies of the files.

Use FORMAT to Initialize

When the Hard Disk System is installed, all hard disk drives are effectively "blank." Consequently, each drive (Primary and Secondary) must be formatted before the Hard Disk System can operate under hard disk control.

Once the System is powered-up, you must initialize the Primary Drive by transferring the operating system (TRSDOS-II) to Drive 4. To do this, use the utility **FORMAT**, which is contained on the **TRSDOS-II Operating System** diskette.

Follow this procedure to format Drive 4 and move TRSDOS-II to Drive 4.

1. Power up your System as described earlier.
2. The error message **BOOT ERROR HN** will be displayed. Press RESET then **(REPEAT) (BREAK)** or **(REPEAT) (ESC)**.

If Drive 4 has previously been formatted and if you wish to re-format, you will need to insert the floppy diskette containing the **FORMAT** program into Drive 0 and start-up the System under control of floppy diskette TRSDOS-II as described earlier.
3. When the prompt **INSERT DISKETTE** appears, insert the floppy diskette (labeled **TRSDOS-II Operating System**) into Drive 0 and close the drive door.
4. Answer the date and time prompts.
5. When **TRSDOS-II Ready** appears, type **FORMAT**, specify any options, and press **(ENTER)**. (**FORMAT 4 HDS=6, CYL=306 (ENTER)** will format drive 4 for 6 read/write heads and 306 cylinders and automatically transfer TRSDOS-II to drive 4. (The **FORMAT** program takes about 15-20 minutes to run.)

The **FORMAT** program will then load and format Drive 4. **FORMAT** will automatically move TRSDOS-II to the Hard Disk (Drive 4).
6. When **TRSDOS-II Ready** re-appears, you may either format the secondary hard disk (5) or press RESET to boot from the newly formatted drive 4.

7. The System will then repeat the power-up sequence but "go" directly to Drive 4 and load TRSDOS-II. The prompt **TRSDOS-II Ready** will then appear.
8. Remove the floppy diskette (which contains TRSDOS-II) and store it in a safe place.

Preparing Your Secondary Hard Disk (Drive 5)

You can then format the Secondary Hard Disk Drive (5), if you have one. (See FORMAT command on page 35.)

Note: This disk cannot be write protected by use of the write protect switch.

The FORMAT Command.

This is the format to use in typing the FORMAT Command:

FORMAT

Erase and Format a Disk/Diskette

FORMAT :*d* {*options*}

d specifies the drive to be formatted and is a number from 0-7 (with Built-in Hard Disk System the number is from 0-5). *d* is optional; if omitted, TRSDOS-II will prompt for the drive number.

{*options*} is one or more of the following:

ABS = tells TRSDOS-II not to prompt if the specified drive contains data. If ABS is omitted, TRSDOS-II prompts before overwriting any existent data.

ID = *disk-name* tells TRSDOS-II the name to assign to the disk. If omitted, TRSDOS will be used.

PW = *password* tells TRSDOS-II the master password to assign to the disk. If omitted, PASSWORD is used. The master password allows access to all user files (via the PROT command).

DIR = *nnn* tells TRSDOS-II where to place the primary directory. For hard disks, *nnn* can be any number between 0-300; for floppy diskettes, 1-71. If omitted, cylinder 44 is used for floppy diskettes, cylinder 130 for hard disks.

ALT = *nnn* tells TRSDOS-II where to place the alternate directory. If *nnn* = 000, an alternate directory will not be created. If omitted, the formula *directory + 3* is used to compute placement of the alternate directory. For floppy diskettes, 3 represents three tracks; for hard disks, 3 represents three cylinders. For hard disks, *nnn* can be any number between 0-303; for floppy diskettes, any number between 1-74. The default value is 52.

SIZ = *nnnn* tells TRSDOS-II how many filenames to allow for in the initial directory. For hard disks and floppy diskettes, *nnnn* can be any number between 1-1220. If omitted, 180 is used for floppy diskettes; 336 for hard disks. If **SIZ** = *nnnn* is specified, TRSDOS-II rounds off to the next multiple of 4.

ILV = *nn* when used, it sets the interleave factor (ratio of *n*:1), which determines the order in which TRSDOS-II is to access disk sectors. Between disk accesses, TRSDOS-II must do a certain amount of processing. (The amount depends upon your application.) The proper ILV factor can reduce the processing by minimizing disk rotation between accesses. If you omit the option, *nn* defaults to 10.

Hard Disk only

HDS = *nn* tells TRSDOS-II the number of heads on the drive. This is required for Hard Disks. If omitted, TRSDOS-II prompts you for the number. This number can be 1 to 6. For 15-Meg the number is 6.

CYL = *nnnn* tells TRSDOS-II the number of cylinders on the drive. This is required for Hard Disks. If omitted, TRSDOS-II prompts you for the number. This number cannot be less than 128. The number for 15-Meg is 306.

PRE = *nnn* tells TRSDOS-II the precompensation start cylinder (128 or greater). Default value is 128. DIR and ALT defaults will be increased automatically to be greater than the precompensation to ensure the most reliable directory access.

verification level is one of the following:

FULL reads the value of each sector and compares that value with what was written during formatting.

NONE No verification is done. *verification level* is optional: if omitted, FULL is used.

With TRSDOS-II, this FORMAT consists of 32 sectors per track instead of the TRSDOS 26. Because of this, floppy diskettes formatted by TRSDOS-II cannot be used under TRSDOS and vice versa.

For more details on FORMAT, see your TRS-80 Computer owner's manual.

Examples

FORMAT 5 (ENTER)

formats the diskette on Drive 5, using the default values for options. You will be prompted for HDS and CYL numbers.

FORMAT 2 (ENTER)

formats the diskette in floppy Drive 2, using the default values for floppy diskettes.

FORMAT (ENTER)

prompts you for the drive to use before it begins formatting. Since no options are specified, the disk will have the option's defaults. If hard disk you will be prompted for HDS and CYL numbers.

FORMAT :5 {DIR = 75} (ENTER)

formats the disk in Drive 5, placing the primary directory on cylinder 75. You will be prompted for HDS and CYL numbers.

Preparing Your TRSDOS Application Programs

Many Radio Shack application programs use TRSDOS instead of TRSDOS-II. You can use TRSDOS programs in two ways:

- Operate under floppy diskette control (see Chapter 7).
- Use the FCOPY command to convert them to the TRSDOS-II format and copy them to your hard disk. (Instructions are in the insert supplied with the *TRSDOS-II Reference Manual*.) After converting your programs, you can load them under TRSDOS-II, as instructed in Chapter 2.

Copying TRSDOS-II Programs onto a Hard Disk

TRSDOS-II programs use TRSDOS-II as their operating system. If you have one of these programs, you can use it in two ways:

- Operate under floppy diskette control (see Chapter 8).
- Use the MOVE command to copy the program from floppy diskette to hard disk. (See the *TRSDOS-II Reference Manual*.)

Creating a Backup Library

Through operator error, power failure, or other accidents, you can lose information stored on hard disk. To prevent the loss of a day's, week's, or even month's work, keep up-to-date copies of all the files that are on your hard disk. Instructions are in your *TRSDOS-II Reference Manual* (see SAVE and RESTORE) and Appendix C of this manual.

Running TRSDOS-II Programs Under Hard Disk Control

To run TRSDOS-II programs under hard disk control, do not press **(RPT)** **(BREAK)** after powering up your system. Otherwise, power up as instructed in Chapter 3.

If you have not yet copied your application programs to hard disk, insert the floppy diskette with the program in Drive 0. Then run the program by entering the name of the program.

For example:

If the program's name is SCRIPSIT, type:

SCRIPSIT **(ENTER)**

SECTION III/ FLOPPY DISKETTE PREPARATION

This section shows how to prepare your TRSDOS-II/TRSDOS diskettes to run under floppy diskette control.

You can use your TRS-XENIX diskettes only under hard disk control — not under floppy diskette control.



CHAPTER 6: BACKING UP TRSDOS-II AND TRSDOS 2.0b SYSTEMS DISKETTES

Sometimes information stored on diskette is lost. This problem can result from:

- Worn-out or mishandled disks
- Mishandled equipment
- The power going out while you're using the system

That is why it is important to make "backup" copies of **all** the information you store on diskettes.

Note: Backup is not possible under floppy control with a single floppy drive configuration. References to floppy drives other than drive 0 are for users with floppy expansion drives.

Backing Up Your TRSDOS-II System Diskette

To copy your TRSDOS-II System Diskette, you must use the TRSDOS-II BACKUP utility. This utility automatically "formats" (organizes) the diskette to which the information is to be copied ("destination" diskette). It then backs up the "source" diskette to the destination.

Customers with only one floppy drive: You cannot backup the TRSDOS-II diskette. Use the TRSDOS 2.0b diskette instead.

Customers with two or more floppy drives: Follow these steps:

1. Prepare a destination diskette by covering the write-protect notch of a blank diskette with a write-enable tab.
2. Power up or reset the system. Press **(RPT) (BREAK)** to operate under floppy diskette control.
3. Insert the TRSDOS-II System Diskette ("source" diskette) into Drive 0.
4. When prompted, enter the date in mm/dd/yyyy format (for example: 03/19/1983 for March 19, 1983). Press **(ENTER)** when prompted for the time. TRSDOS-II Ready is displayed.
5. Insert the destination diskette into Drive 2. It can be a single- or double- sided diskette. (Using a double-sided diskette doubles its storage capacity.)
6. Type:
 BACKUP 0 TO 2 **(ENTER)**
7. If you are using an old diskette instead of a blank diskette, the following message might be displayed:
 DESTINATION Disk Contains Data. Copy Over It (Y/N)?
If you do not need the data on the diskette, type Y **(ENTER)**. If you might need the data, type N **(ENTER)**.

BACKUP displays the following message when the backup is complete:

```
Backup Successfully Complete
Drive 2 Disk ID is:
TRSDOS-II Ready
```

If your screen displays a message that the backup aborted, repeat Steps 5 through 7, using a different destination diskette.

Backing Up Your Thinline TRSDOS 2.0b Diskette

To back up your Thinline TRSDOS 2.0b Diskette, you must use the TRSDOS FORMAT and BACKUP utilities. The FORMAT utility organizes the diskette to which the information is to be copied ("destination" diskette). BACKUP then copies all the information from the "source" diskette to the destination.

To format a blank diskette and then back up your Thinline TRSDOS 2.0b Diskette, follow these steps:

1. Prepare a destination diskette by covering the write-protect notch of a blank diskette with a write-enable tab.
2. Power up or reset the computer. Press **(RPT)** **(BREAK)** to operate under floppy diskette control.
3. Insert the TRSDOS 2.0b Diskette ("source" diskette) into Drive 0.
4. When prompted, enter the date in mm/dd/yyyy format (for example: 03/19/1983 for March 19, 1983). Press **(ENTER)** when prompted for the time. TRSDOS READY is displayed.

Customers with two or more floppy drives:

5. Insert the destination diskette into Drive 2. At TRSDOS READY, type:
FORMAT 2 **(ENTER)**
6. The following prompt is displayed on the screen:
Mount Diskette for Formatting on Drive 2.
Continue? (Y/Q)
Since you already have mounted your diskette on Drive 2, type Y **(ENTER)** to continue.
7. If you are formatting over a used diskette, the following prompt might appear:
Diskette CONTAINS DATA; Format OVER it? (Y/Q)
If you do not need the data on the diskette, type Y **(ENTER)**. If you might need the data, type Q **(ENTER)**.

-
8. TRSDOS READY is displayed when the formatting is complete. Type:

BACKUP 0 TO 2 **(ENTER)**

To answer the following questions, type Y **(ENTER)**:

Source Diskette Ready? (Y/Q)

Destination Diskette Ready? (Y/Q)

9. When the question:

Change diskette information? . .

is displayed, type N **(ENTER)**.

10. When the backup is complete, TRSDOS READY is displayed. If your screen displays a message that the backup aborted, repeat Steps 5 through 10, using a different destination diskette.

Customers with only one floppy drive:

5. At TRSDOS READY, type: FORMAT 0 **(ENTER)**

When the message:

Mount Diskette for Formatting on Drive 0

Continue? (Y/Q)

is displayed, insert the destination diskette into Drive 0. Type Y **(ENTER)** to continue.

6. When the formatting is complete, the following message is displayed:

Insert SYSTEM diskette Press ANY key to continue

Remove the formatted destination diskette and place the TRSDOS 2.0b Diskette ("source" diskette) in Drive 0.

7. At TRSDOS READY, type: BACKUP 0 TO 0 **(ENTER)**

8. Type Y **(ENTER)** to answer the following question:

Source Diskette Ready? (Y/Q)

9. When the question:

Change diskette information? . .

is displayed, type N **(ENTER)**.

10. When the message:

Insert DESTINATION diskette Press ANY key to continue

is displayed, remove the TRSDOS 2.0b Diskette and insert the destination diskette into Drive 0. Press **(ENTER)**. The backup continues.

You are alternately prompted to insert the source diskette and the destination diskette.

11. When the message

Insert SYSTEM diskette Press ANY key to continue

is displayed, the backup is complete. Remove the destination diskette and insert the TRSDOS 2.0b Diskette into Drive 0. Press **(ENTER)**, and TRSDOS READY is displayed.

Tips on Safeguarding Data

To ensure the safety of your data and programs:

- Store all original operating system and application program diskettes in a safe place.
- Run the system with copies of your original TRSDOS-II Systems Diskette, TRSDOS 2.0b Diskette, Hard Disk Operating System Initialization Diskette, and application program diskettes.
- Every time you create or update a file, copy it to another diskette or make a backup of the diskette.
- Take proper care of your system and disks as instructed in Chapter 9, "Maintenance."

Accidents happen, so think about how much time, effort, and money could be lost if you decide not to make backup copies.

CHAPTER 7: USING TRSDOS PROGRAMS

This chapter explains how to:

- Prepare TRSDOS application programs for use. (TRSDOS-II application programs require no preparation. Load them as instructed in Chapter 6.)
- Format data diskettes for use with TRSDOS or TRSDOS-II application programs.

If you are going to use the hard disk unit, go to Chapter 5, "TRSDOS-II Hard Disk System Preparation (FORMAT)."

Preparing TRSDOS Programs

All Model II programs currently distributed by Radio Shack run under the TRSDOS operating system.

If you have TRSDOS application programs, you may do one of the following:

- Convert your programs to TRSDOS-II and then load them as TRSDOS-II programs
- Run your TRSDOS programs, as is, with a backup of your TRSDOS 2.0b System Diskette in Drive 0
- Convert your TRSDOS diskettes to TRSDOS 2.0b (to run on Thinline drives)

Converting TRSDOS to TRSDOS-II

TRSDOS-II is a greatly enhanced version of TRSDOS. It can be used with either floppy or hard disk drives. It stores and retrieves information much faster and can store more information per disk. And it lets you use double-sided diskettes.

To use TRSDOS-formatted programs under TRSDOS-II, you must copy the programs and data to disks formatted by TRSDOS-II. The insert in your *TRSDOS-II Reference Manual* explains how to convert your programs. You must have more than one floppy diskette to use TRSDOS-II.

Using TRSDOS Diskettes "As Is"

If you have enough drives, you can simply insert the TRSDOS 2.0b diskette in Drive 0 and the TRSDOS diskettes in the other drives.

Then press the reset button. Press the break and repeat keys. The system starts up under TRSDOS 2.0b. Enter the date and time; TRSDOS READY is displayed. Now you can load and run your programs under TRSDOS 2.0b.

Converting TRSDOS Diskettes to TRSDOS 2.0b Diskettes

If you do not have enough drives for the above method, you will want to convert your TRSDOS diskettes.

A special file called THINLINE is supplied on the TRSDOS 2.0b System Diskette. When you copy this file to a TRSDOS diskette, it makes a patch to TRSDOS which allows it to run on Thinline drives.

You do not need to patch data diskettes since they do not contain TRSDOS.

- 1a. **Multi-Drive Users:** Power up the Built-in Hard Disk System with the Thinline TRSDOS 2.0b diskette in Drive 0 and the TRSDOS diskette in Drive 2. If you have a hard disk, press **(RPT) (BREAK)** to operate under floppy diskette control. After entering the date and time, type:

COPY THINLINE:0 :2 **(ENTER)**

- 1b. **Single-Drive Users:** Power up your Built-in Hard Disk System with the Thinline TRSDOS 2.0b System Diskette in Drive 0. Press **(RPT) (BREAK)** to operate under floppy diskette control. Type:

COPY THINLINE:0 :0 **(ENTER)**

You are prompted when to mount the source diskette (TRSDOS 2.0b) and the destination diskette (TRSDOS).

2. When the copy is complete, remove the TRSDOS 2.0b diskette from Drive 0. Move your TRSDOS diskette, which now contains the file THINLINE, to Drive 0. Without pressing reset, type:

DO THINLINE **(ENTER)**

This makes the patch to the TRSDOS diskette.

Converting TRSDOS 2.0b Diskettes Back to TRSDOS

At some time, you may want to "undo" your TRSDOS 2.0b patch so that you can use your converted TRSDOS 2.0b diskette on an Enhanced Model II. To reverse the patch, you must use a file called UNTHIN.

- 1a. **Multi-Drive Users:** Power up your Built-in Hard Disk System with a backup of the TRSDOS 2.0b System Diskette in Drive 0 and the TRSDOS 2.0b diskette (to be "unpatched") in Drive 2. If you have a hard disk, press **(RPT) (BREAK)** to operate under floppy diskette control. After entering the date and time, type:

COPY UNTHIN:0 :1 **(ENTER)**

-
- 1b. **Single-Drive Users:** Power up the Built-in Hard Disk System with a backup of the TRSDOS 2.0b System Diskette in Drive 0. Press **(RPT)** **(BREAK)** to operate under floppy diskette control. Type:

COPY UNTHIN:0 :0 **(ENTER)**

You are prompted when to mount the source diskette (Thinline TRSDOS 2.0b System Diskette) and the destination diskette (TRSDOS 2.0b diskette to be unpatched).

2. When the copy is complete, remove the TRSDOS 2.0b System Diskette from Drive 0. Move the diskette to be unpatched to Drive 0. Without pressing reset, type:

DO UNTHIN **(ENTER)**

Now you can use the unpatched TRSDOS diskette in a Model II system.

Removing and Swapping Diskettes

To avoid losing data, follow these steps whenever you remove or swap diskettes.

- When you are finished using a diskette, exit the application program by returning to the Ready prompt. Make sure the drive light is off. Then remove the diskette.
- When swapping diskettes in a drive, type I **(ENTER)** after inserting the new diskette.
- If you swap the diskettes in Drive 0, they must contain the same operating system. If they do not, press the reset button after the swap to start up the new operating system.
- When you're finished using the Built-in Hard Disk System, remove all diskettes and turn it off.

Formatting Diskettes

Your Built-in Hard Disk System can store information on formatted disks. Operating system and application program disks are formatted, but they may not have enough space for other information.

If you have a multi-drive System, you may wish to store information on "data diskettes." A data diskette is formatted but does not contain an operating system. It has more storage space than an operating system or application program diskette.

Caution: While a diskette is being formatted, any previous information on the diskette is **erased**.

Formatting TRSDOS Data Diskettes

To make a data diskette to use with a TRSDOS application program, follow these steps:

1. Power up the system.
2. Place a write-enable tab over the write-protect notch of the diskette to be formatted (destination diskette).
3. Insert a backup of your TRSDOS System Diskette or TRSDOS 2.0b System Diskette into Drive 0. (If you have a hard disk, make sure you are operating under floppy diskette control.)
4. Enter the date and time.
5. When TRSDOS READY is displayed, insert the destination diskette into Drive 2. Type:
FORMAT 2 **(ENTER)**
6. If you are formatting over a used disk, a prompt appears asking you if you want to format over it. If you do not need the data on the diskette, type Y **(ENTER)**. If you might need the data, type Q **(ENTER)**.

TRSDOS READY is displayed when the disk is formatted.

Using TRSDOS Data Diskettes. Place a backup of your TRSDOS 2.0b System Diskette in Drive 0. Insert the data diskette(s) in the other floppy drive(s). Then use the application program as instructed in the application program manual.

Formatting TRSDOS-II Data Diskettes

To make a data diskette to use with a TRSDOS-II application program, follow these steps:

1. Power up the system.
2. Place a write-enable tab over the write-protect notch of the diskette to be formatted (destination diskette).
3. Insert the TRSDOS-II Systems Diskette in Drive 0. (If you have a hard disk, make sure you are operating under floppy diskette control.)
4. Enter the date and time.
5. When TRSDOS-II Ready is displayed, insert the destination diskette into Drive 2. Type:
FORMAT 2 **(ENTER)**
6. If you are formatting over a used disk, a prompt appears asking you if you want to format over it. If you do not need the data on the diskette, type Y **(ENTER)**. If you might need the data, type Q **(ENTER)**.

TRSDOS-II Ready is displayed when the disk is formatted.

Using TRSDOS-II Data Diskettes. Place a backup of your TRSDOS-II Systems Diskette in Drive 0 and load the appropriate system. Insert the data diskette(s) in the other floppy drive(s). Then use your application program as instructed in the application program manual.

CHAPTER 8: SAMPLE SESSION

TRSDOS-II Programs

To load TRSDOS-II and then load and run BASIC, use the following steps:

1. Power up your system press **(RPT)** **(BREAK)** until INSERT DISKETTE is displayed.
2. Insert your Systems Diskette into Drive 0.
3. Enter today's date in the format displayed on your screen. For example, for August 23, 1983, type:

08/23/1983 **(ENTER)**

4. To skip the ENTER TIME prompt now on your screen, press **(ENTER)**. This starts the time at 000.00.00. Or, enter the time in the displayed, 24-hour format (seconds are optional). For example, for 2:30 p.m., type:

14.30 **(ENTER)**

Your screen shows:

TRSDOS-II Ready
.....

This message indicates that TRSDOS-II is ready to accept a command or load an application program.

Notice that TRSDOS-II powers up with key-click turned on. Each time you press a key, the system generates a click. To turn the key-click off, type CLICK OFF and press **(ENTER)**.

5. All commands must be entered in capital letters. To load BASIC, type:

BASIC **(ENTER)**

BASIC displays its start-up message and:

Ready
>

Ready > indicates that BASIC, not TRSDOS-II, is ready to accept a command or program statement.

You cannot use TRSDOS-II and an application program, such as BASIC, at the same time. For example, if you type a TRSDOS-II command while BASIC is controlling the system, an error message is displayed. The application program did not understand the command, and TRSDOS-II did not receive the command.

6. Type the TRSDOS DIR command: DIR **(ENTER)**

Your screen shows:

?SN Error
Ready
>

?SN Error indicates that BASIC doesn't understand the TRSDOS-II command. (You can execute a TRSDOS-II command from BASIC via the SYSTEM command described in the *BASIC Reference Manual*.)

-
7. Try writing a BASIC program by typing the following:

```
10 CLS (ENTER)
20 PRINT "HELLO" (ENTER)
```

If you type a line incorrectly, press (ENTER) and type it correctly.

8. Test the program by typing BASIC's RUN command:

```
RUN (ENTER)
```

Your screen should show:

```
HELLO
Ready
>
```

The "Hello" program you typed is stored in memory. You can run it whenever you wish until you exit the BASIC program (TRSDOS-II resumes control). If you want to keep the program to run later, you must store it permanently before exiting BASIC.

9. To save the "Hello" program for future use, type:

```
SAVE "SAMPLE" (ENTER)
```

10. To return to TRSDOS-II Ready, type:

```
SYSTEM (ENTER)
```

Now you can run the "Hello" program whenever you wish. To do so, use the diskette you are using now. Load the BASIC interpreter by typing BASIC (ENTER). To load the SAMPLE program, type:

```
LOAD "SAMPLE" (ENTER)
```

Run the program by typing RUN (ENTER).

**SECTION IV/
MAINTENANCE AND
APPENDICES**



CHAPTER 9: MAINTENANCE

Care of Floppy Diskettes

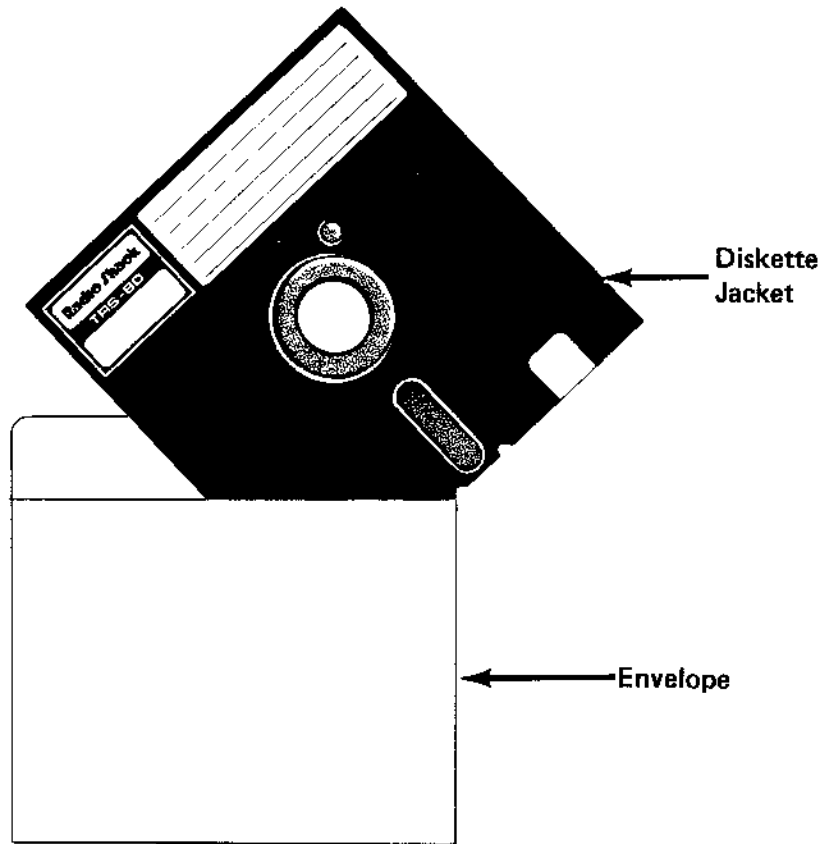

Diskettes are sensitive. A small dent or scratch or a speck of dust can destroy a diskette's contents. Treat your diskettes with care.

- Never turn the system on or off while a diskette is in a drive.
- Store diskettes in their envelopes, making sure there is no pressure to their sides.
- Keep diskettes away from magnetic fields (such as transformers, AC motors, magnets, TVs, radios, and a system's display console).
- Don't bend diskettes.
- Never touch a diskette's exposed shiny surfaces. Do not try to wipe or clean diskette surfaces; they scratch easily.
- Keep diskettes out of direct sunlight and away from heat.
- Keep diskettes away from cigarette ashes, dust and other particles. In dusty areas, provide filtered air to the computer room.
- Don't write on the diskette label with a hard point device such as a ball point pen or lead pencil. Use a felt-tip pen only.

Labeling Diskettes

Your original operating system and application diskettes have permanent labels on their jackets. Blank (unformatted) diskettes come with labels for you to write on and place on the diskettes' jackets.

Write on them with a felt-tip pen only. Don't erase or scratch out information on these labels.

Floppy Disk Drive Maintenance

Your computer's floppy disk drives need periodic preventative care to prevent damage to your diskettes. Make sure a Radio Shack maintenance person checks your floppy disk drives every six months or less.

Ask the sales representative at a Radio Shack Computer Center about disk drive head cleaning kits.

Secondary Hard Disk Drive Maintenance

Hard disk drives don't require the same maintenance as floppy disk drives, but they do require special care. For example, never move your hard disk drives while they're powered up. Also, be sure that the air around your hard disk is as free of dust and other particles as possible.

Clean the filter on the back of the secondary unit when filled with dust and particles. Carefully remove the outer grill. **DO NOT REMOVE THE SCREWS.** Remove the filter and rinse with tap water. When the filter is completely dry, put it back in the drive.

APPENDIX



APPENDIX A: Problems and Error Messages

Unreadable Disks, Files, and Programs

If you suddenly cannot use your disk, files, or programs, static electricity might be the cause. Try humidifiers and anti-static carpets to get rid of static electricity.

There are other causes. The System's built-in AC line filter shields the system from minor changes in AC power, but extreme changes can ruin programs and files. If you think this is the problem, try these remedies:

- Fix defective switches on nearby machines.
- Install bypass/isolation devices on noisy machines in your area.
- Install a separate power line to your system.

Error Messages

Whenever the System is turned on or reset, it executes a built-in diagnostic program to help insure that the System is in good working order. If the System detects a hardware fault or other problem, it will display an error message — then stop. This checkout program reduces the chance that you will lose time or data without knowing it because of a defective system.

This program does not check for multiple faults; as soon as the first fault is found, the System displays the appropriate message and stops.

Before suspecting hardware problems, try the operation several times. Recheck to see that all power and interconnections are correct. As a last resort, try re-formatting the Operating System on the Hard Disk Drive. Remember! FORMAT will erase all data on Drive 4. To prevent losing data altogether, be sure to keep backup copies of all data on the disk as you go along.

If a displayed error message looks like:

- **** ERROR 24 **** or **FILE NOT FOUND**, see the Operating System Errors table.
- **BOOT ERROR DC**, see the Boot Errors table.
- Neither of the above, see your application program manual. (It might also be a descriptive operating system error generated by the application program.)

To get a brief description of a numbered error, type ERROR followed by the number. For example, type:

```
ERROR 31 (ENTER)
```

and your screen shows:

```
PROGRAM NOT FOUND
```

When an error message is displayed:

- Try the operation several times.
- Look up boot errors and operating system errors in the following tables and take the recommended actions. See your application program manual for explanations of application program errors.
- Try using other diskettes.
- Reset the System and try the operation again.
- Check all the power connections.
- Check all interconnections.
- Remove all diskettes from drives, turn off the system, wait 15 seconds, and turn it on again.
- If you try all these remedies and still get an error message, contact a Radio Shack Service Center.

If there is more than one error message, the system might wait until you correct the first error before displaying the second error message.

Operating System Errors

Message	Explanation/Action	Code
Address Out Of Range.	SVC Block or the SVC argument is not within the memory range.	131
Attempt To Open A File Which Has Not Been Closed.	Close the file before re-opening.	6
Attempt To Read Past EOF.	Specified record number is past the end of file.	28
Attempt To Use A NON Program File As A Program.	File specified for execution is not a program file or the load address given is illegal. Make sure you have a system diskette in Drive 0 (if under floppy control).	34
Bad Block Format.	Check the format of the SVC block for errors.	129
Bad CRT Number.	For multi-user only.	133
Bad Function Code On SVC Call Or No Function Exists.	Check the function code number used on the SVC call.	1
Bad Partition Number.	For multi-user only.	132
BOOT ERROR	See the BOOT ERROR TABLE.	

In the tables, RSSC = Radio Shack Service Center.

Message	Explanation/Action	Code
Character Not Available.	No record or character was available when you called the SVC.	2
CRC Error During Disk I/O.	Try the operation again, using a different diskette. If the problem occurs often, contact RSSC.	4
DCB Is Modified And Is Unusable.	DCB (used in machine-language programming) has been modified since the last disk file access (while the file was open).	16
Data Lost During Disk I/O (Hardware Fault).	Contact RSSC.	41
Debug Not Configured.	Include DEBUG at configuration time.	135
Device Not Assigned.	For multi-user only.	137
Device Not Available.	For multi-user only.	136
Directory Read Error.	Error occurred during an attempt to read the directory. Try a different diskette.	17
Directory Space Full.	Number of filenames has reached the amount set when you formatted the diskette.	26
Directory Write Error.	Error occurred during an attempt to write to the directory. Use a different diskette.	18
Disk Drive Not Ready.	Drive door is open or the diskette is not in the drive. On thinline drives, check the Drive command settings.	8
Disk Is Write Protected.	Write enable the disk.	15
Disk Sector Not Found.	Try a different diskette.	5
Disk Space Allocation Cannot Be Made Due To Fragmentation Of Space.	Use the COPY command to copy the files and reduce fragmentation.	33
Disk Space Full.	No space is available on the disk.	27
DO-Nesting Not Allowed.	A DO command was encountered within a DO file.	128
File Access Denied Due To Password Protection.	You gave an incorrect password. See ATTRIB command.	25

Message	Explanation/Action	Code
File Already in Directory.	Filename already exists as a directory entry. Kill the existing file, choose another filename, or specify a drive number.	11
File Not Found.	Filename you gave was not found on the available disks or the file is the incorrect type for the desired operation.	24
Hardware Fault During Disk I/O.	Contact RSSC.	49
I/O Attempt To An Unopen File.	Open the file before access.	38
Illegal I/O Attempt.	<ul style="list-style-type: none"> a. MOUNT/DDISMOUNT or I command was not given during diskette swap. b. Can be caused by an I/O attempt to a differently formatted disk. Format the disk under the current version of TRSDOS-II or use FCOPY. c. When initializing a hard disk, you must also format the secondary drives. 	39
Illegal Disk Change.	The operating system detected an illegal disk swap.	7
Illegal File Type.	File type you used (FLR or VLR) is not the type required by the system.	144
Illegal Operation Requested.	For multi-user only.	134
Improper File Name (Filespec).	Filespec you gave does not meet the standard file specifications.	19
Incorrect Command Parameter.	Option or argument given in the command is incorrect.	48
Invalid Data Provided By Caller.	Data stream to be processed has illegal characters.	9
Invalid Space Descriptor.	The space descriptor that tells the operating system which extent to read next is invalid. Try a different diskette.	50
Maximum Of 16 Files May Be Open At Once.	Too many files are open at once.	10

Message	Explanation/Action	Code
Memory Fault During Program Load.	Program is loaded incorrectly, possibly because of faulty memory or a "bad" load address.	35
No Drive Available For An Open.	No on-line drive a. is write enabled b. has enough space to create a new file, or c. has a system directory.	12
No Error Found.	No error occurred.	0
No More Extents Available (16 Maximum).	Use the COPY command to copy the files and reduce fragmentation. See also SAVE/RESTORE and MOVE.	30
Not Applicable To VLR Type Files.	Operation performed is not valid for VLR files.	46
Odd Address.	Address required by the SVC block must be even.	130
Open Attempt For A File Already Open.	File specified for open is already open.	37
Out Of Range (Address Error).	Overflow occurred in the user stack during the SETBRK SVC or SETTRP SVC operation.	139
Parameter Error On Call.	Parameter is incorrect or a required parameter is missing.	3
Parameter For Open Is Incorrect.	Check the OPEN statements or the DCB for errors.	36
Printer Fault (May Be Turned Off).	Check the connections, power, ribbon, on-line status, and so on.	44
Printer Not Available.	Check the connections, power, ribbon, on-line status, and so on.	45
Printer Not Ready.	Check the connections, power, ribbon, on-line status, and so on.	42
Printer Out Of Paper.	Check the printer's paper supply.	43
Program Not Found.	Specified program is not found on available disks.	31
Read Attempt Outside Of File Limits.	Use valid record numbers.	29
Required Command Parameter Not Found.	Required parameter or argument is missing from the command.	47

Message	Explanation/Action	Code
Seek Error.	a. Data cannot be read from the disk — faulty disk.	40
Too Many Pending Calls.	For multi-user only.	142
Unknown Drive Number (Filespec).	Specified drive number is not valid.	32
** Unknown Error Codes **		51-127
Write Attempt To A Read Only File.	File was opened for read only, not for read/write.	13
Write Fault On Disk I/O	Error occurred during a write operation. Try a different diskette. If the problem continues, contact RSSC.	14

Boot Errors

Error	Message	Explanation/ Action
BOOT ERROR CT	Defective CTC chip.	Contact RSSC.
BOOT ERROR DC	Floppy disk controller error. a. Defective diskette. b. Floppy disk expansion unit not on. c. Defective FDC Chip or Drive. d. System was not powered up in the proper sequence.	a. Try a different diskette. b. Turn on the floppy disk expansion unit. c. Contact RSSC. d. Turn off the system and power it up in the proper sequence.
BOOT ERROR DM	DMA chip failure.	Contact RSSC.
BOOT ERROR D0	Drive Not ready. a. Improperly inserted diskette. b. Defective diskette. c. Defective drive.	a. Insert the diskette again and press (RESET) . b. Try a different diskette. c. Contact RSSC.
BOOT ERROR HA	Controller error. Aborted command: Problem during boot-up of hard disk.	Re-initialize the hard disk or contact RSSC.

Error	Message	Explanation/ Action
BOOT ERROR HC	CRC error. Invalid data in data field.	Re-initialize the hard disk or contact RSSC.
BOOT ERROR HD	Controller error. Busy not reset.	a. Re-initialize the hard disk. b. Power down, wait 10 seconds, and power up. If the error occurs again, contact RSSC.
BOOT ERROR HI	CRC error. Invalid data in ID field.	Re-initialize the hard disk.
BOOT ERROR HM	Data address mark not found.	Re-initialize the hard disk.
BOOT ERROR HN	ID not found. No Boot Track.	Re-initialize the hard disk.
BOOT ERROR H0	Track 0 error on hard disk. a. Didn't find Track 0 before time-out. b. Secondary hard disk drive is not on.	a. Press (RESET) . b. Contact RSSC.
BOOT ERROR HT	Time-out while waiting for Ready. a. Hard disk drives not powered up. b. Hard disk drive isn't turned on and ready within 10 seconds after the computer. c. Hard disk drive is disconnected.	a. Contact RSSC. b. Press (RESET) . c. Connect the hard disk drive or operate under floppy disk control.
BOOT ERROR LD	Lost data during read — FDC (floppy disk controller) or drive fault.	Try another system diskette or contact RSSC.
BOOT ERROR MF	Memory failure in address range X'1000'-X'7FFF'.	Contact RSSC.
BOOT ERROR MH	Memory failure in address range X'8000'-X'FFFF'.	Contact RSSC.
BOOT ERROR ML	Memory failure in address range X'0000'-X'0FFF'.	Contact RSSC.

Error	Message	Explanation/ Action
BOOT ERROR PI	Defective PIO Chip.	Turn on the expansion bay if it is off. If the error occurs again, contact RSSC.
BOOT ERROR RS	The diskette in Drive 0 is not Radio Shack operating system format.	Insert a TRSDOS-II formatted diskette into Drive 0 and Press (RESET) .
BOOT ERROR SC	CRC Error. Invalid data on diskette or defective diskette.	Try a different diskette.
BOOT ERROR TK	Record not found bootstrap track. Improperly formatted or defective diskette.	Re-format your diskette or try a different diskette.
BOOT ERROR Z8	Defective CPU.	Contact RSSC.
NOT A SYSTEM DISK	Diskette in Drive 0 isn't a TRSDOS-II operating system diskette.	Insert a system diskette into Drive 0.

APPENDIX B: The BACKUP and SAVE/RESTORE Utilities

Of the many ways to copy information from a disk, the SAVE and BACKUP utilities are used most often.

SAVE usually is used to copy all the information on a hard disk to floppy diskettes. The SAVE command is discussed later in this appendix. The *TRSDOS-II Reference Manual* also has information on SAVE.

BACKUP is used to copy all the information on one diskette to another. This appendix tells how to back up system diskettes (diskettes that contain an operating system) and data diskettes.

Note: BACKUP is not possible under floppy control with a single floppy drive configuration. References to floppy drives other than 0 are for users with floppy expansion drives.

TRSDOS-II Backup

The TRSDOS-II BACKUP utility makes a copy of a diskette. If you have enough floppy diskette drives, you can use this utility to copy and TRSDOS-II system or data diskette.

Note: You cannot back up a double-sided to a single-sided diskette.

Backing Up TRSDOS-II System Diskettes

If you have at least two floppy diskette drives, you can back up **any** diskette that contains the TRSDOS-II system. Follow the steps given under "Backing Up Your TRSDOS-II Systems Diskette," in Chapter 3.

Backing Up TRSDOS-II Data Diskettes Using a Floppy Diskette System

Follow these steps to back up a TRSDOS-II data diskette:

1. Power up your system. Insert a backup of your TRSDOS-II Systems Diskette into Drive 0. Insert the source data diskette into Drive 2.
2. Enter the date and time.
- 3a. **Three-Drive Users:** Insert the destination diskette into Drive 3. Use a double-sided diskette for maximum storage space. Type:
BACKUP 2 TO 3 (ENTER)
"Backup Successfully Completed" is displayed when the backup is finished.
- 3b. **Two-Drive Users:** Type:
BACKUP 2 TO 0 (ENTER)

The message

Replace system diskette with destination diskette. Ready (Y) . .

appears. Remove your Systems Diskette from Drive 0 and insert the destination diskette. Type Y **(ENTER)**; the backup continues.

When the backup is complete, the message

Mount system disk. Ready (Y) . .

is displayed. Remove the destination diskette from Drive 0 and insert your Systems diskette. Type Y **(ENTER)**; the Ready prompt is displayed.

Backing Up TRSDOS-II Data Diskettes Using a Hard Disk System

You need at least two floppy diskette drives for this method.

1. Power up under hard disk control.
2. Insert the TRSDOS-II source data diskette into Drive 0. Insert the destination diskette into Drive 2. Use a double-sided diskette for maximum storage space.
3. Enter the date and time.
4. When TRSDOS-II Ready is displayed, type:

BACKUP 0 TO 2 **(ENTER)**

"Backup Successfully Completed" is displayed when the backup is finished.

TRSDOS Backup

The TRSDOS BACKUP utility makes a copy of a diskette. If you have enough floppy diskette drives, you can use this utility to copy any TRSDOS system or data diskette.

When backing up **any** TRSDOS diskette, keep TRSDOS 2.0b in Drive 0. Put the diskette you wish to back up ("source" diskette) in another drive.

Backing Up TRSDOS System Diskettes

To back up any diskette that contains TRSDOS, follow the steps given under "Backing Up Your Thinline TRSDOS 2.0b Diskette," in Chapter 7. Substitute the TRSDOS system diskette for the TRSDOS 2.0b System Diskette.

Model 16B and Enhanced Model 12 Users: To back up a TRSDOS system diskette, you must first patch it for use on Thinline drives. (See "Loading a TRSDOS Program" in Chapter 6.)

Backing Up TRSDOS Data Diskettes

1. Power up your System.
2. If you have a hard disk, press **(RPT) (BREAK)** to operate under floppy diskette control. Insert the TRSDOS 2.0b System Diskette into Drive 0.

3a. **Two-Drive Users:** Type:

FORMAT 2 **(ENTER)**

When TRSDOS READY is displayed again, remove the destination diskette from Drive 2. Insert the source diskette. At TRSDOS READY, type:

I **(ENTER)**

BACKUP 2 TO 0 **(ENTER)**

When the message "Destination Diskette Ready? (Y/Q)" is displayed, remove your TRSDOS 2.0b System Diskette from Drive 0. Insert the formatted destination diskette.

After the backup is finished and TRSDOS READY is displayed, you are prompted to insert a system diskette into Drive 0.

3b. **Three-Drive Users:** Insert the source data diskette in Drive 2 and the destination data diskette in Drive 3. Type:

FORMAT 3 **(ENTER)**

When TRSDOS READY is displayed again, type:

BACKUP 2 TO 3 **(ENTER)**

TRSDOS READY is displayed when the backup is finished. With TRSDOS 2.0b in Drive 0, you can now use your backup data diskette in another drive.

BACKUP

Duplicate a Diskette

BACKUP *source TO destination {options}*

source and *destination* are drive numbers in the form of *d*, where *d* is a floppy diskette (0-3) only.

options is one or more of the following:

PW = *source-password* tells TRSDOS-II the master password of the source diskette. TRSDOS-II will not duplicate the diskette unless you give the correct password. **PW** = is optional; if omitted, TRSDOS-II will assume the password is **PASSWORD**.

NEW = *destination-password* tells TRSDOS-II the password to assign to the destination diskette. The master password allows access to all user files via the **PROT** command. **NEW** = is optional; if omitted, TRSDOS-II will use the same password as the source diskette.

ID = *diskette-name* tells TRSDOS-II the diskette name to assign to the destination diskette. **ID** = is optional; if omitted, TRSDOS-II will use the diskette name of the source diskette.

ABS = tells TRSDOS-II not to prompt you if the specified drive contains data. ABS is optional; if ABS is omitted, TRSDOS-II will prompt before overwriting any data that already exists on the floppy disk.

This utility allows you to make a "mirror image" of a TRSDOS-II floppy diskette onto another floppy diskette. Diskettes do not need to be formatted before BACKUP. BACKUP automatically formats during the track-by-track duplication.

Note: BACKUP is used for floppy-to-floppy duplication only. If you want floppy-to-hard, use **FCOPY**, **SAVE/RESTORE**, or **COPY**.

The TRSDOS-II BACKUP utility is much faster than the TRSDOS BACKUP because it makes a "mirror image" on a track-by-track basis instead of file-by-file.

Single-drive BACKUPS are not allowed with the TRSDOS-II BACKUP command.

TRSDOS-II BACKUP will not allow the following TRSDOS options:

- wildcarding
- prompting before each file
- NOAUTO
- SYS

Examples

```
BACKUP 3 TO 2 {PW = ASHER} (ENTER)
```

makes a mirror image copy of the diskette in Drive 3 to the diskette in Drive 2, using the password ASHER.

```
BACKUP :2 TO :0 {NEW = TEST} (ENTER)
```

copies the diskette in Drive 2 to Drive 0 and assigns the password TEST to the new diskette.

Making SAVE/RESTORE Compressed Copies

This section is an introduction to the TRSDOS-II SAVE and RESTORE utilities.

The SAVE utility stores files in a special, compact form on floppy diskettes. Because of the special format, files occupy less space than they normally would on floppy diskettes. TRSDOS-II cannot directly read files stored in this format.

The RESTORE utility returns saved information to a disk formatted under TRSDOS-II. It is the only way to retrieve the information stored by SAVE.

SAVE is a good way to make archive copies of hard disk files. To decide how often to make save copies of your hard disk files, think how much time, effort, and money could be lost if your hard disk files suddenly were destroyed. We suggest hard disk users keep two major sets of archive files:

-
- Monthly Save Set — A set of save diskettes that contains everything on your hard disks, including your programs. Make this set on the first day of each month. Always keep a previous month's save set and a current month's save set.
 - Daily Save Set — A set of save diskettes that contains files that were created or changed since the current monthly save set was made. Make this set at the end of each day. Always keep a previous daily save set and a current daily save set.

If you enter large amounts of data every day, you might want to make more than one "daily" save set each day. No matter how much data you enter, however, never wait longer than three days before making a daily save set.

Note: The examples in this section use Drive 4 (hard disk) as the source and Drive 0 as the destination. This is because SAVE and RESTORE are intended for hard disk use. However, SAVE and RESTORE can also be used to save files from a TRSDOS-II formatted floppy diskette to a SAVE formatted diskette.

When using SAVE and RESTORE between two floppy diskettes, be sure:

- the source and destination drive numbers are different
- the destination drive is not Drive 0; Drive 0 must contain a TRSDOS-II system diskette

Note: Neither SAVE nor RESTORE is possible under floppy control with a single floppy drive configuration. References to floppy drives other than 0 are for users with floppy expansion drives.

Creating a Monthly Save Set

Creating a monthly save set takes time, but it's worth it. Have several blank, unformatted diskettes ready.

To save all the files (including system files) and programs from hard disk Drive 4 to a floppy diskette in Drive 0, insert a floppy diskette into Drive 0. At TRSDOS-II Ready, type:

```
SAVE :4 :0 {SYS,ALL,ABS} ENTER
```

TRSDOS-II displays a "volume number" which identifies the diskette in Drive 0. A "dataset signature" identifies the set of diskettes. Write down the volume number and dataset signature. When you later remove the diskette from the drive, write this information on the diskette's label.

When the diskette is full, TRSDOS-II prompts you to insert another diskette. When all the files are saved, TRSDOS-II prompts you to reinsert the first diskette of the set (Volume 0). It then updates the diskette with housekeeping information.

TRSDOS-II Ready appears when the SAVE is finished. Make sure you have labeled all the save diskettes. Store them in a safe place.

At the beginning of the next month, create a new monthly save set using a different set of diskettes. This set becomes the "current monthly save set." The other set becomes the "previous monthly save set."

Rotating Monthly Save Sets

When you have two monthly save sets, begin rotating the diskettes. When you make a new monthly save set, use the older monthly save set diskettes instead of blank diskettes.

Creating a Daily Save Set

To create a daily save set of all the Drive 4 files that were created or changed since the monthly save set was created, type:

```
SAVE !:4 :0 {DM>mmddy,ABS,SYS} (ENTER)
```

Instead of typing "mmddy," type the date that you made the most recent monthly save set.

At the end of the next day, create a new daily save set, using different diskettes. This set becomes the "current daily save set." The other set is the "older daily save set."

Rotating Daily Save Sets

Once you have two daily save sets, rotate the diskettes. When you make a new daily save set, use the older daily save set diskettes instead of blank diskettes.

SAVE

Backup File to Floppy Diskette

SAVE *source TO destination {options}*

source may be one of the following:

:d which is a drive specification and is a number between 0-7.

filespec:d specifies a TRSDOS-II file or INDIRECT file to be saved.

wildcard:d is a TRSDOS-II wildcard and includes a disk drive number (0-7).

destination specifies a floppy disk drive number and is a number between 0-3 in the form *d*.

{options} is one or more of the following:

ABS tells SAVE not to prompt for destination disk status.

SAVE will format the destination disk if it is not already in SAVE format.

DC *value date* will compare the creation date of each specified source file against the date entered and SAVE the file if all other criteria are met. *value* is <, >, or = where < (less than) and > (greater than) mean less than or equal to and greater than or equal to. *date* must be in the form: MMDDYY

DM *value date* will use the last modification date in the manner specified above. *value* is <, >, or = where < (less than) and > (greater than) mean less than or equal to and greater than or equal to. *date* must be in the form: MMDDYY

IND (indirect) tells SAVE to use the contents of the source file as a list of source filespecs that meet the requirements stated above.

PROMPT will prompt for file verification before SAVEing. You may respond with **Y** (yes), **N** (no), **Q** (quit) or **S** (stop prompting and continue).

ALL tells TRSDOS-II to save all files. (All won't transfer System files, use SYS.) If you use drive as source, you must use ALL.

SYS allows you to SAVE language and application programs.

Wildcarding

Wildcards also offer an easy way to save several files or an entire disk. For example:

```
SAVE */CBL:4 TO 0 (ENTER)
```

saves all Drive 4 files with the extension /CBL and puts them on the diskette in Drive 0.

Using the IND Option

The indirect option lets you save groups of files by creating an indirect file, a file consisting of one or more filespecs (similar to a DO file). You can use the BUILD command to create this list of filespecs.

When TRSDOS-II Ready, type:

```
BUILD PROGRAMS:0 (ENTER)
```

This creates an indirect file called PROGRAMS.

After TRSDOS-II prompts you with:

```
Enter command line (1-80)
```

```
.....  
enter your list of file specifications including drive numbers, for  
example:
```

```
ORDERS:5 (ENTER)  
REPORTS/*:6 (ENTER)
```

To exit the BUILD and return to TRSDOS-II Ready, press **(BREAK)**.

You are now ready to save the files (specified by the indirect file) to the specially formatted floppy diskette. Type:

```
SAVE PROGRAMS:0 TO 2 {IND} (ENTER)
```

Both ORDERS and REPORTS are now found in the file named PROGRAMS on the diskette in Drive 0 and saved to the diskette in Drive 2.

Note: The IND option lets you save more than one file from each hard disk; it also lets you save from more than one hard disk. As a result, you might save multiple files that have the same name. Because the save and restore directory does not specify drive numbers for files, you could lose duplicate filenames.

For example, if you created an indirect file that has these files:

```
*/FOR:4
*/CLB:4
*/FOR:5
```

Drives 4 and 5 may have duplicate filenames with the /FOR extension. Before you use indirect, examine all the files to be saved. Rename any duplicate filenames before saving.

Using the DC and DM Options

Another way to save files is to do so with respect to their creation or modification (update) dates. For example, suppose your directory showed these creation and update dates for your files:

Filename	Created	Updated
MENU/PRG	6/1/81	9/2/81
PRGONE/PRG	6/1/81	9/16/81
PRGTWO/PRG	6/1/81	7/30/81
PRGTHR/PRG	6/1/81	6/16/81
PAYROLL/DAT	9/15/81	10/15/81
CHECKS/DAT	9/15/81	10/15/81
TEST/PRG	10/29/81	10/29/81

If you want to save only those files created on June 1, 1982, use the following command:

```
SAVE */*:5 TO 0 {DC=060182} ENTER
```

The first four files are saved to the floppy diskette in Drive 0.

In the same sense, the first four files were updated on or before September 2, 1982 (9/2/82). Type:

```
SAVE */PRG:5 TO 0 {DM<090282} ENTER
```

and all files updated before the specified date are saved.

BUILD

Create an Automatic Command Input File

BUILD *file*

file is a file specification which cannot include an extension.

The BUILD command allows you to create or edit a DO file on a line by line basis.

When you enter a BUILD file that already exists, TRSDOS-II will display the first line of the file, followed by the prompt:

```
Keep, Delete, Fix, Replace, Insert or Quit?  
Enter (K/D/F/R/I/Q) . . ?
```

The Fix option lets you edit the displayed command line.

Example

Suppose you have a command file named TRANSFER that consists of the lines:

```
COPY FILE/1
COPY FILE/2
COPY FILE/3
DIR
```

You can fix one of the lines of the command file without retyping the entire line.

Load the command file by typing:

```
BUILD TRANSFER (ENTER)
```

TRSDOS-II will display the first line of the file, followed by the options:

```
COPY FILE/1
Keep, Delete, Fix, Replace, Insert or Quit?
Enter (K/D/F/R/I/Q) . . ?
```

To change the filename in the first line, type F **(ENTER)**. TRSDOS-II will display the line with the cursor over the first character in the line. Use the **(→)** (rightarrow) to position the cursor over the letter F, then type:

```
NEWFILE (ENTER)
```

TRSDOS-II will position the cursor at the beginning of the line. Press **(ENTER)** again and the Fixed line will be saved. You can now edit the next command line.

Restoring your Files

To restore information to a hard disk other than Drive 4, replace "4" with the desired drive number in each of the following commands.

Restoring One File

If you want to restore only one file, insert Volume 0 of your most recent save set into Drive 0 and type:

```
RESTORE filespec:0 :4 {ABS} (ENTER)
```

where *filespec* is the name of the file you want to restore.

Restoring a Group of Files

To restore a group of files, insert Volume 0 of your most recent save set into Drive 0. Type:

```
RESTORE :0 :4 {PROMPT} (ENTER)
```

TRSDOS-II prompts you before restoring each file. Press **(Y)** to restore a file. Press **(N)** if you don't wish to restore the file.

Restoring All Files

If you lose most or all of the data on your hard disk(s), follow these steps to recover the lost data:

1. If Drive 4's operating system is damaged, re-transfer

TRSDOS-II and BASIC from the diskette supplied with your hard disk to Drive 4. See the instructions in chapter 5 (FORMAT).

If you are sure Drive 4's operating system is not damaged, go to Step 2.

2. Insert Volume 0 of your current monthly save set into Drive 0. At TRSDOS-II Ready, type:

RESTORE :0 :4 {ABS,SYS} **(ENTER)**

Follow TRSDOS-II's prompts.

3. Insert Volume 0 of your current daily save set into Drive 0. At TRSDOS-II Ready, type:

RESTORE :0 :4 {ABS,SYS} **(ENTER)**

4. Re-enter any information added to the hard disk since the last current daily save set was created.

To save the contents of your hard disk system:

1. Transfer control to the floppy disk system (press **(BREAK)** **(REPEAT)** during "white-out").

2. Insert a diskette containing the floppy version of TRSDOS-II in Drive 0 and start up the system so that you see TRSDOS-II Ready.

3. To be sure there is a chance to save the contents of your hard disk, try to get a directory of your primary hard disk drive. Type:

DIR 4 **(ENTER)**

If you can get a directory, then you probably can save the contents of your hard disk.

4. Save the contents of your primary hard disk drive. Insert a blank diskette in Drive 2 (or 3) and type:

SAVE 4 TO 2 (or 3) {SYS,ALL,ABS} **(ENTER)**

5. Re-format your primary hard disk drive. (Once the contents of your hard disk are saved, you must re-format your primary hard disk drive.) (See the FORMAT command in this manual for details.)

6. When the FORMAT process is finished, (in about 15 to 20 minutes), you can restore the files that you saved. Type:

RESTORE 2 (OR 3) TO 4 {SYS} **(ENTER)**

Note: When a Boot Error Occurs on Hard Disk

If your hard disk system returns a boot error, flip the RESET switch on the front of your computer. Then, try to start up your system again. If your system continues to return a boot error, you probably have lost the boot track, Track 0.

Even when this happens, there is a way to save the contents of your primary hard disk. But, to do so, you must have at least two floppy disk drives on your system.

RESTORE

Recover SAVED Files

RESTORE *source* TO *destination* {*options*}

source specifies a floppy diskette and is one of the following:

d where *d* is a drive specification and a number between 0-3.

filespec:d where *filespec* is a standard TRSDOS file specification and *drive* is a drive number between 0 and 3.

wildcard:d where *wildcard* is a standard TRSDOS wildcard and *drive* is a number between 0 and 3.

destination is optional and is one of the following:

d where *d* is a drive specification and a number between 0-7. *d* cannot be the same as *source*.

filespec:d where *filespec* is a standard TRSDOS-II file and *d* a drive specification. If IND is used, *d* is optional.

{*options*}

 is one or more of the following:

ABS tells TRSDOS-II to retrieve the specified file(s). If used, an already existing file with the same name will be written over.

DIR If VOLUME 0 is in source drive, TRSDOS-II will display the DATASET directory and identifier; if VOLUME 0 is not a source drive, TRSDOS-II will display only the DATASET identifier.

IND (indirect) tells TRSDOS-II to use the contents of the destination file as a list of destination filespecs that meet the requirements stated above.

KILL tells TRSDOS-II to kill the specified destination file before it is opened for RESTOREing.

PROMPT will prompt for verification of each file for RESTOREing. Press **Y** (yes), **N** (no), **Q** (quit restoring), or **S** (stop prompt).

PRT can only be used with the DIR option. Prints the DIRectory listing on the line printer.

SYS TRSDOS-II will retrieve System and data files. This includes System (language) and Applications programs. If used with DIR, SYS will list the directory of System files.

To retrieve all non-system files, specify both the *source* and *destination* as drive numbers.

RESTORE reads information from a dataset created by SAVE. If you enter a volume of this dataset out of sequence, TRSDOS-II informs you of the mistake. The system also informs you if you accidentally enter a volume from a different dataset during a RESTORE.

Note that the TRSDOS-II diskette must remain in Drive 0 on floppy drive systems. Also, single-drive saves and restores are not allowed. For example, RESTORE :2 :2 is illegal.

When you're restoring files in a dataset, TRSDOS-II prompts you with:

Mount NEXT Diskette in Drive *n* — Press ANY Key to continue, which instructs you to enter the next volume of the dataset.

Examples

RESTORE 0 TO 4 (ENTER)

retrieves all saved non-system files on Drive 0 and puts them in Drive 4.

RESTORE !:2 TO 4 (ENTER)

retrieves all saved non-system files, with and without extensions, from the floppy diskette in Drive 2 and puts them on the hard disk in Drive 4.

RESTORE 2 PROGRAMS {IND} (ENTER)

where PROGRAMS is an indirect file containing the files:

MAILIST/PRG:4
MAILDAT/TXT:4
CHANGES/TXT:4

retrieves the files from the floppy diskette in Drive 2 and puts them in the filespecs, defined in PROGRAMS, on hard disk Drive 4. Note that "TO" is optional.

























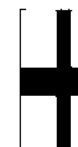







RESTORE */SRC:0 4 (ENTER)

retrieves all Drive 0 user files that have the extension /SRC and puts them on hard disk Drive 4. The filenames stay the same.

RESTORE :2 {DIR,PRT}

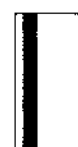
sends the directory of the floppy diskette in Drive 2 to the printer.

APPENDIX C: Graphics Codes

							
00	01	02	03	04	05	06	07
							
08	09	0A	0B	0C	0D	0E	0F
							
10	11	12	13	14	15	16	17
							
18	19	1A	1B	1C	1D	1E	1F

APPENDIX D: Specifications

The Radio Shack TRS-80 15-Meg Built-in Hard Disk System is a disk-based computer system with two major parts:

- A display console with a Built-in Hard Disk System and a built-in double-sided, double-density floppy disk drive.
- A detached keyboard which can be positioned for your comfort and efficiency

The operating system software is loaded from a system diskette in Drive 0 or Drive 4 by a built-in ROM "bootstrap" program.

Processors

Input/Output Processor System

- Z80-A based with 64K bytes of random access memory
- Independent bus can support all the standard system boards
- Emulation mode lets you execute programs previously developed for the TRS-80 Model II without changing them first.

Computational Processor System

- 68000 based with either 128K or 256K (384K or 512K bytes on a Model 16B) of RAM
- Independent bus can support multiple bus masters

The two processors share the computing load from the application programs (the Z80-A based processor performs input/output tasks while the 68000 based processor performs computational tasks).

Video Display

LSI Controller Chip

Frees the input/output (Z80-A based) processor from much of the overhead required to update and maintain the video display.

Four Modes

- Green/White on black (normal)
- Black on green/white (reversed)
- 80 characters by 24 lines
- 40 characters by 24 lines

Displayable Characters

- Full ASCII set
- 32 graphics characters

Keyboard

- LSI Controller frees the input/output (Z80-A based) processor from keyboard scan and related tasks
- Located in a separate case for convenience
- Model 16B and Enhanced Model 12 are connected to the display console via a built-in, coiled cord that exits at the lower, back part of the keyboard
- Standard typewriter keys, repeat key and eight general-purpose function keys
- Four modes with the following priority (highest to lowest):
 1. Unshift
 2. Shift
 3. Caps
 4. Control

Floppy Diskette Drives

Minimum

- One built-in, 8-inch, double-sided floppy diskette drive

Maximum

- One built-in and up to two external, 8-inch, double-sided, floppy diskette drives (floppy diskette expansion unit needed for two external drives)

Preventive Maintenance Interval

- Typical usage (3,000 power-on hours per year): Every 8000 power-on hours
- Heavy usage (8,000 power-on hours per year): Every 5000 power-on hours

Required Media

- Radio Shack double- or single-sided, 8-inch floppy diskettes
- Enhanced Model II: Radio Shack single-sided, 8-inch floppy diskettes

Data Transfer Rate is 500,000 bits per second (except Track 0 which has 250,000 bps).

Diskette Life is 3.5 million passes per track. To prevent limiting life by improper handling, follow diskette-care recommendations.

Power Supply

Power Requirements

- 105 - 130 VAC, 60 Hz
- 240 VAC, 50 Hz (Australian)
- 220 VAC, 50 Hz (European)
- Grounded outlet

Maximum Current Drain

- 2.0 Amps

Typical Current Drain

- 1.5 Amps

Warm-Up Period

Minimum Delay To Turn System On After Turning Off — 15 seconds

Operating Temperature

- 55 to 85 degrees Fahrenheit
- 13 to 29 degrees Centigrade

Peripheral Interfaces

Standard

- Serial port A (RS-232C)
- Serial port B (RS-232C)
- Parallel input/output channel, for connection to TRS-80 standard parallel interface line printers
- Floppy diskette input/output channel for connection of a floppy diskette expansion unit
- Hard Disk Drive Interface

Optional

- ARCNET Interface
- Graphics Board

Serial Interface

Two Ports:

- Channel A allows asynchronous or synchronous transmission.
- Channel B allows asynchronous transmission only.
- Both conform to the RS-232C standard.

- Both use the DB-25 connectors on the back of the display console.

The DB-25 connector pin-outs and signals available are listed below.

Channel A Standard RS-232C Signal		Pin #	Channel B Standard RS-232C Signal		Pin #
I/O Transmit S.E.T.		15	Ground		1,7
Ground		1,7	Receive Data		3
Receive Data		3	Receiver Xmitter Clock		17
Receiver Clock		17	Data Set Ready		6
Transmit Clock		24	Clear-to-Send		5
Data Set Ready		6	Carrier Detect		8
Clear-to-Send		5	Transmit Data		2
Carrier Detect		8	Request-to-Send		4
Transmit Data		2	Data Terminal Ready		20
Request-to-Send		4			
Data Terminal Ready		20			

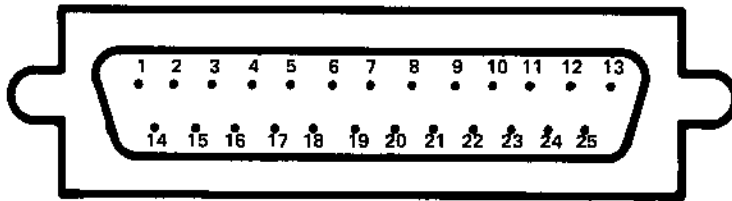

Parallel Interface

- Connection to a line printer via the 34-pin connector on the back panel of the display console
- Eight data bits are output in parallel
- Four data bits are input
- All levels are TTL compatible

The connector pin-outs and signals available are listed on the next page.

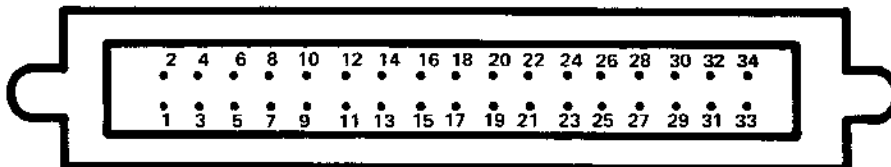

Signal	Function	Pin #
ACK*	Input to the computer from the printer; low indicates data byte is received	19
BUSY	Input to the computer from the printer; high indicates busy	21
PAPER EMPTY	Input to the computer from the printer; high indicates no paper — if the printer doesn't provide this, the signal is forced low	23
BUSY*	Input to the computer from the printer; low indicates device is selected	25
PRIME*	Output to the printer to clear the buffer; reset the printer logic	26
FAULT*	Input to the computer from the printer; low indicates fault (paper empty, light detect, deselect, and so on)	28
GROUND	Common signal ground	2,4,6,8,10, 12,14,16,18, 20,22,24,27, 31,33
NC	Not connected	29,30,32,34

*These signals are active-low.

Secondary Hard Disk Power Requirements

AC Power Requirements

50/60 Hz \pm 0.5 Hz

100/115 VAC Installations (90 to 127V at 1.1A typical)

200/230 VAC Installations (100 to 253V at 0.6A typical)

Disk Characteristics (Initialized to TRSDOS-II)

No. of Cylinders	306
No. of Heads	6
Track Access Time	3msec
Data Transfer Rate	5.0MB/Sec

Dimensions (Case)

Height	5.5" (140 mm)
Width	14" (356 mm)
Depth	15" (381 mm)
Weight	15.5 lbs. (7.02 kg)

Environment

Ambient Temperatures

Operating:	55 to 85 degrees F. (13 to 29 degrees C.)
Nonoperating:	-40 to 140 degrees F. (-40 to 60 degrees C.)

Relative Humidity

8% to 80%

Relative Humidity Gradient

Operating:	20% per hour
Nonoperating:	Below that causing condensation

Maximum Wet Bulb Temp.

78.8 F. (26 C.) degrees
non-condensing

Heat Dissipation

150 Watts (511 BTU/Hr) Max.

Altitude

Operating Density-Altitude 1500 to
9750 ft. (457 to 2972 m.) Storage 0 to
12000 ft. (0 to 3650 m.)

Hard Disk Drive

Disk Organization (Initialized To TRSDOS-II)

Cylinders per Disk	306
Tracks per Unit	1836
Tracks per Platter	612
Sectors per Track	34
Bytes per Sector	256
Average Latency	8.3 msec
Rotational Speed	3600.0 rpm
Recording Density	9625.0 bpi
Flux Density	9625.0 fci
Track Density	345.0 tpi

Storage Capacity (Hard Disk)

Unformatted	
Per Drive	19.0 Mbytes
Formatted	
Per Drive	15.5 Mbytes (Primary)
	15.9 Mbytes (Secondary)

Storage Capacity (TRSDOS-II Formatted Floppy Diskette)

Sectors per Track	320
Bytes per Sector	256
Bytes per Diskette	625,920
Tracks (single-side)	76

Model 16B Built-in Hard Disk System /Model 16B Built-in Hard Disk System Communications

For hard-wiring between two Model 16Bs with Built-in Hard Disks but without a modem, use the wiring arrangement illustrated below (Model 16B to Model 16B only).

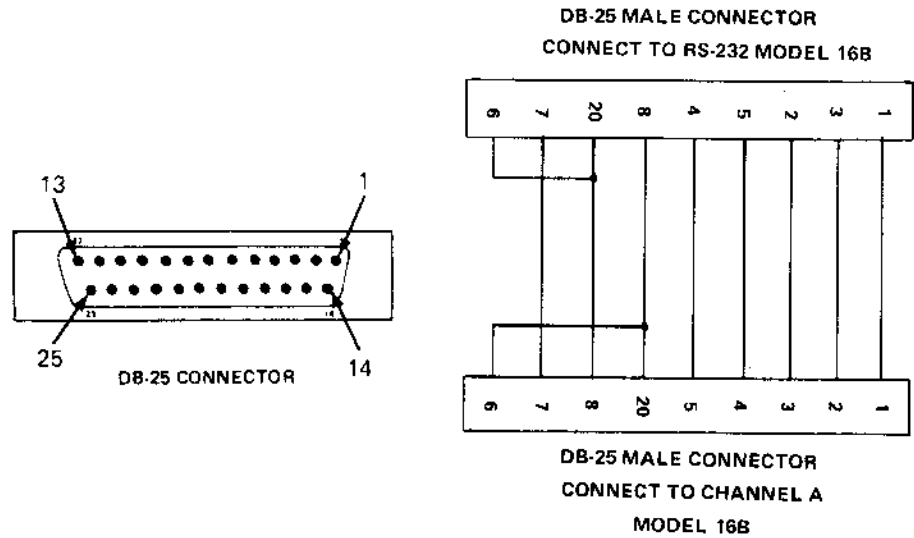

Connection Diagram, Model 16B (Channel A or B) to Model 16B (Channel A or B). Use stranded wire, 24-gauge, to connect two DB-25 connectors as illustrated. If the wire length exceeds 50 feet, twist Lines 7 (GND), 2 (TD), and 3 (RD).

APPENDIX E

FLOPPY DISKETTES	HARD DISKS
<p>Types of Diskettes: Double-sided (cannot be used by Enhanced Model IIs) Single-sided</p> <p>Write-Protection: Covering the write-protect notch lets you change information</p> <p>Primary Drive: Drive 0</p>	<p>Modes of Operation: Floppy diskette control (Press <<REPEAT>><<BREAK>> on startup) Hard disk control (automatic)</p> <p>Write-Protection: Lighting the PROTECT button invokes write protection</p> <p>Primary Drive: Floppy diskette control — Drive 0 Hard disk control — Drive 4</p>

	TRSDOS-II Operating System	TRSDOS Operating System
Mode	Z80 code	Z80 code
Startup	With TRSDOS-II in the primary drive, press <<HOLD>. Enter the date and time.	With TRSDOS in the primary drive, enter the date and time.
Switching to:		
TRSDOS-II	Not applicable	At READY with TRSDOS-II in primary drive, press RESET and <<HOLD> entering the date.
TRSDOS	At Ready with TRSDOS in Drive 0, press RESET (if hard disk, press <<REPEAT>><<BREAK>>).	Not applicable
Type of Disks Recognized	Single- and double-sided diskettes, and hard disks	Single-sided diskettes only
Transferring Disk Files to Hard Disk	At Ready, enter: MOVE source TO destination Example: MOVE 1 to 4 (ALL)	Must transfer to TRSDOS-II. At TRSDOS-II Ready, enter: FCOPY source TO destination Example: FCOPY 1 TO 4 (ALL)
Formatting:		
Single-drive	Not allowed	At READY, enter: FORMAT 0
Multi-drive	At Ready, enter: FORMAT drive Example: FORMAT 1	At READY, enter: FORMAT drive Example: FORMAT 1
BACKUP	(Formatting is automatic)	(Must format first)
Single-drive	Not allowed	At READY, enter: BACKUP 0 TO 0
Multi-drive	At Ready, enter: BACKUP source TO destination Example: BACKUP 0 TO 1	At READY, enter: BACKUP source TO destination Example: BACKUP 0 TO 1



APPENDIX F: Keyboard Code Map

The keyboard code map shows the code that TRSDOS-II returns to the user for each key, in each of the modes — unshift, shift, caps, and control.

A program executing under TRSDOS-II — for example, BASIC — may translate some of these codes into other values. Consult the program's documentation for details.

Note: The **BREAK** key (code X'03') is always intercepted by TRSDOS-II. It is never returned as a character.

ESC 1B	21 ! 21 1 31 31	40 @ 40 2 32 32	23 # 23 3 33 33	24 \$ 24 4 34 34	25 % 25 5 35 35	7E ^ 5E 6 36 36	26 & 26 7 37 37	2A * 2A 8 38 38	5C (28 9 39 39
TAB 09	11 Q 51 51 71	17 W 57 57 77	05 E 45 45 65	12 R 52 52 72	14 T 54 54 74	19 Y 59 59 79	15 U 55 55 75	09 I 49 49 69	O
CTRL	LOCK	01 A 41 41 61	13 S 53 53 73	04 D 44 44 64	06 F 46 46 66	07 G 47 47 67	08 H 48 48 68	0A J 4A 4A 6A	0B K 4B 4B 6B
CAPS	SHIFT	1A Z 5A 5A 7A	18 X 58 58 78	03 C 43 43 63	16 V 56 56 76	02 B 42 42 62	0E N 4E 4E 6E	0D M 4D 4D 6D	3C < 3C 3C 2C ' 2C

LEGEND:

XX	CONTROL
XX	SHIFT
XX	CAPS
XX	UNSHIFT



7C 29 30 30	7F —5F -2D 2D	2B 2B 3D 3D	BACK SPACE 08	BREAK 03
0F 4F 4F 6F	10 P 50 50 70	5B [5B 7B 7B	5D] 5D 7D 7D	HOLD 00
0C 4C 4C 6C	3A : 3A : 3B : 3B	22 " 22 " 27 " 27	ENTER 0D	
	> 3E 3E 2E 2E	? 3F / 2F / 2F	SHIFT	REPEAT

F1 01	F2 02	F3 04	F4 0C	F5 15
← 2C	7 37	8 38	9 39	F6 10
→ 1D	4 34	5 35	6 36	F7 0E
↑ 1E	1 31	2 32	3 33	F8 13
↓ 1F	0 30	.2E	ENTER 0D	

20



INDEX

Subject	Page
Application Programs.....	15, 16
Loading and Executing.....	31
TRS-XENIX Programs.....	21
TRSDOS-II Programs.....	35
TRSDOS Programs.....	31
BACKUP.....	47
BASIC.....	16
Loading.....	35
Running a Program.....	36
Saving a Program.....	36
Boot Errors.....	44
Brightness.....	7
Contrast.....	7
Converting TRSDOS to TRSDOS-II.....	31
Converting TRSDOS to TRSDOS 2.0b.....	32
Converting TRSDOS 2.0b to TRSDOS.....	32
Disk Files.....	15
Display Console.....	7
Drive Latch.....	7
Drive Light.....	7
Floppy Disk Drive	
Maintenance.....	38
Floppy Diskette.....	13
Backup.....	27
Double-Sided.....	13
Expansion Connector.....	10
Formatting.....	33
Inserting.....	18
Labeling.....	14, 38
Maintenance.....	38
Removing.....	20
Sector Hole.....	14
Single-Sided.....	13
Swapping.....	33
Write Protection.....	14
Formatting Disks.....	15
Graphics Codes.....	59
Hard Disk.....	14
Expansion Connector.....	10
Formatting.....	23
Maintenance.....	38
Keyboard.....	8
Keyboard Code Map.....	68
Maintenance.....	37

Subject	Page
Model 16B	
Communication with another Model 16B.....	66
Equipment.....	6
Installation.....	9
Peripheral Equipment.....	10
Power-up.....	17
Power-down.....	20
Operating System Errors.....	40
Operating Systems.....	15
Parallel Printer	
Connector.....	10
Peripheral Equipment.....	10
Power Button.....	7
Power Light.....	7
Primary Disk Drive.....	21
Programs (see Operating Systems and Application Programs)	
Quick Reference Tables.....	67
Reset Button.....	7
RESTORE.....	55, 57
SAVE.....	50, 52
Secondary Hard Disk.....	24, 25
Serial I/O Connector.....	10
Specifications.....	60
Processors.....	60
Video Display.....	60
Keyboard.....	61
Floppy Diskette Drives.....	61
Power Supply.....	62
Operating Temperature.....	62, 65
Peripheral Interfaces.....	62, 63
Strain Relief Bracket.....	11
Thinline TRSDOS	
2.0b Diskette.....	6, 32
Formatting.....	28
Backing Up.....	28
TRSDOS Operating System.....	6
Backup.....	28
Loading.....	31
Swapping Diskettes.....	33
TRSDOS-II Operating System.....	23
Backup.....	27
Loading.....	35
TRSDOS Program Preparation.....	26, 31

Subject	Page
TRS-XENIX Operating System	
Backing Up	21
Formatting	21
Write-Protect Notch	14
Write-Protect Tab	14

SERVICE POLICY

Radio Shack's nationwide network of service facilities provides quick, convenient, and reliable repair services for all of its computer products, in most instances. Warranty service will be performed in accordance with Radio Shack's Limited Warranty. Non-warranty service will be provided at reasonable parts and labor costs.

Because of the sensitivity of computer equipment, and the problems which can result from improper servicing, the following limitations also apply to the services offered by Radio Shack:

1. If any of the warranty seals on any Radio Shack computer products are broken, Radio Shack reserves the right to refuse to service the equipment or to void any remaining warranty on the equipment.
2. If any Radio Shack computer equipment has been modified so that it is not within manufacturer's specifications, including, but not limited to, the installation of any non-Radio Shack parts, components, or replacement boards, then Radio Shack reserves the right to refuse to service the equipment, void any remaining warranty, remove and replace any non-Radio Shack part found in the equipment, and perform whatever modifications are necessary to return the equipment to original factory manufacturer's specifications.
3. The cost for the labor and parts required to return the Radio Shack computer equipment to original manufacturer's specifications will be charged to the customer in addition to the normal repair charge.

RADIO SHACK, A DIVISION OF TANDY CORPORATION

**U.S.A.: FORT WORTH, TEXAS 76102
CANADA: BARRIE, ONTARIO L4M 4W5**

TANDY CORPORATION

AUSTRALIA	BELGIUM	U. K.
91 KURRAJONG ROAD MOUNT DRUITT, N.S.W. 2770	PARC INDUSTRIEL DE NANINNE 5140 NANINNE	BILSTON ROAD WEDNESBURY WEST MIDLANDS WS10 7JN