

BYTE

BYTE GROUP

LPS ✓

CNV —

TEA —

DM 92

FWB

DWT

the small systems journal

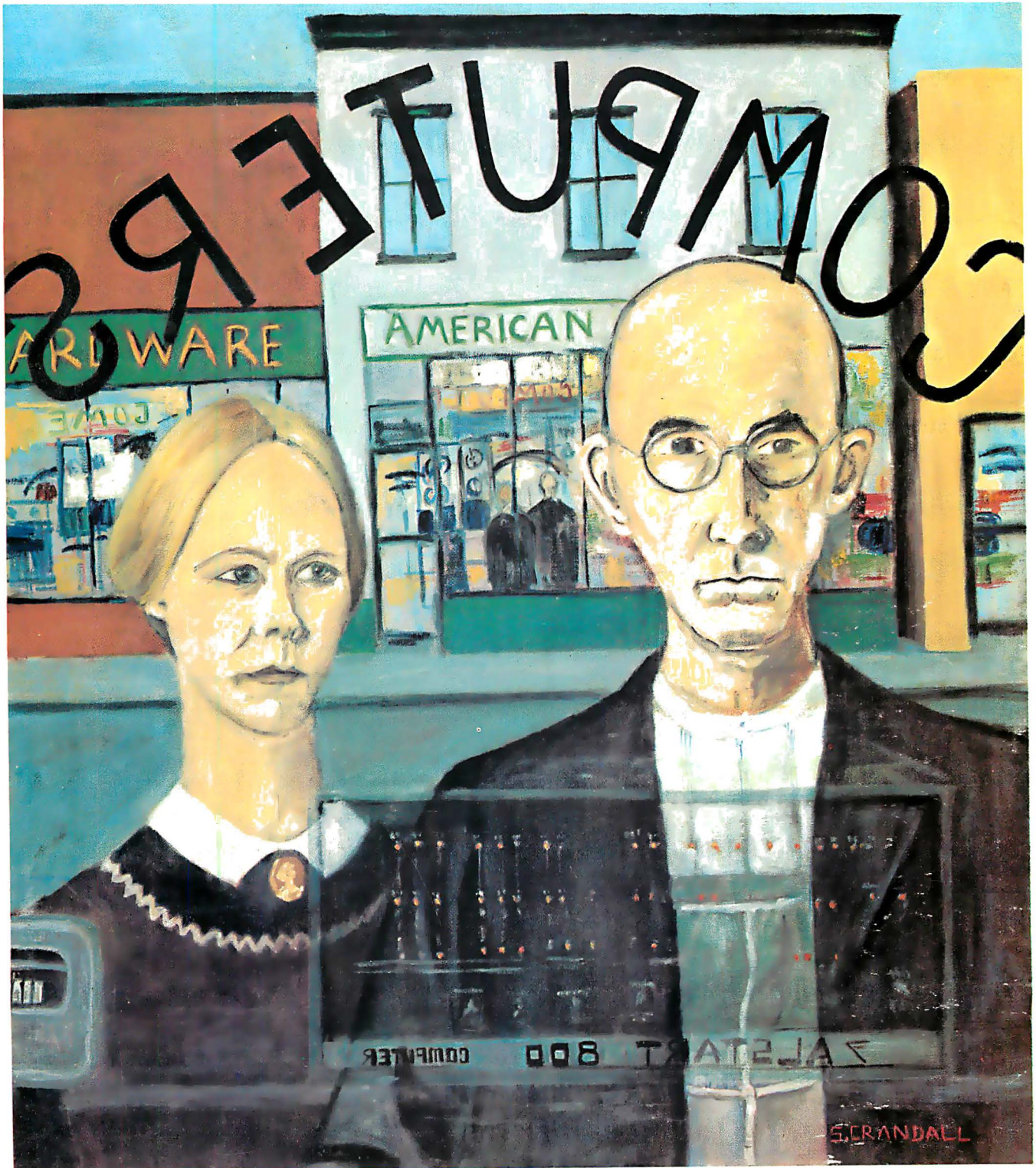

RANDALL

WHY SETTLE FOR LESS— THAN A 6800 SYSTEM

MEMORY—

All static memory with selected 2102 IC's allows processor to run at its maximum speed at all times. No refresh system is needed and no time is lost in memory refresh cycles. Each board holds 4,096 words of this proven reliable and trouble free memory. Cost—only \$125.00 for each full 4K memory.

INTERFACE—

Serial control interface connects to any RS-232, or 20 Ma. TTY control terminal. Connectors provided for expansion of up to eight interfaces. Unique programmable interface circuits allow you to match the interface to almost any possible combination of polarity and control signal arrangements. Baud rate selection can be made on each individual interface. All this at a sensible cost of only \$35.00 for either serial, or parallel type

PROCESSOR—

"Motorola" M6800 processor with Mikbug[®] ROM operating system. Automatic reset and loading, plus full compatability with Motorola evaluation set software. Crystal controlled oscillator provides the clock signal for the processor and is divided down by the MC14411 to provide the various Baud rate outputs for the interface circuits. Full buffering on all data and address busses insures "glitch" free operation with full expansion of memory and interfaces.

POWER SUPPLY—

Heavy duty 10.0 Amp power supply capable of powering a fully expanded system of memory and interface boards. Note 25 Amp rectifier bridge and 91,000 mfd computer grade filter capacitor.

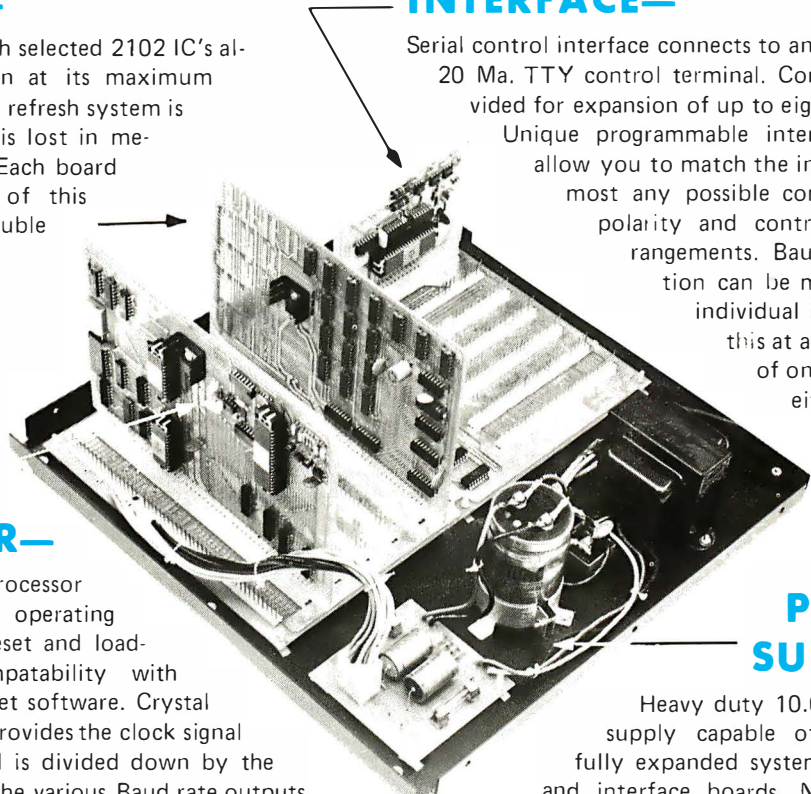

DOCUMENTATION—

Probably the most extensive and complete set of data available for any microprocessor system is supplied with our 6800 computer. This includes the Motorola programming manual, our own very complete assembly instructions, plus a notebook full of information that we have compiled on the system hardware and programming. This includes diagnostic programs, sample programs and even a Tic Tac Toe listing.

Mikbug[®] is a registered trademark of Motorola Inc.

SWTPC 6800
Computer System

with serial interface and 4,096 words of memory. \$395.00



Enclosed is \$395 for my SwTPC Computer Kit Send Data
 or BAC _____ # _____
 or MC _____ Ex Date _____
 NAME _____
 ADDRESS _____
 CITY _____ STATE _____ ZIP _____
 Southwest Technical Products Corp., Box 32040, San Antonio, Texas 78284

Meet the most powerful μ C system available for dedicated work.

Yet it's only \$595*.

*kit price

Here's the muscle you've been telling us you wanted: a powerful Cromemco microcomputer in a style and price range ideal for your dedicated computer jobs — ideal for industrial, business, instrumentation and similar applications.

It's the new Cromemco Z-2 Computer System. In the Z-2 you get all of the following for only \$595:

- The industry's fastest μ P board (4 MHz or 250-nanosecond cycle time).
- The power and convenience of the well-known Z-80 μ P.
- A power supply you won't believe (+8V @ 30A, +18V and -18V @ 15A. That's not only ample power for a full set of cards but ample additional power for other peripherals such as floppy disk drives).
- A full-length **shielded** motherboard with 21 card slots to let you plug in almost any conceivable combination of memory, I/O or your own custom circuits.
- Power-on-jump circuitry to begin automatic program execution when power is turned on.
- The S-100 bus that's widely supported by a host of peripherals manufacturers.
- All-metal chassis and dust case.

- Standard rack-mount style construction that's usable with a variety of cabinets and is upward compatible with larger systems. Bench cabinet optional.
- Card retainer to secure cards in sockets under all conditions.
- 110- or 220-volt operation.

DEDICATED APPLICATIONS

The new Z-2 is specifically designed as a powerful but economical dedicated computer for systems work. Notice that the front panel is entirely free of controls or switches of any kind. That makes the Z-2 virtually tamper-proof. No accidental program changes or surprise memory erasures.

(For your custom work, Cromemco will supply blank panels.)

4 MHz SPEED

Cromemco's microcomputers are the fastest and most powerful available. The 4 MHz speed of the Z-2 means you get about twice the speed of nearly any other microcomputer.

(continued on next page)



 **Cromemco**

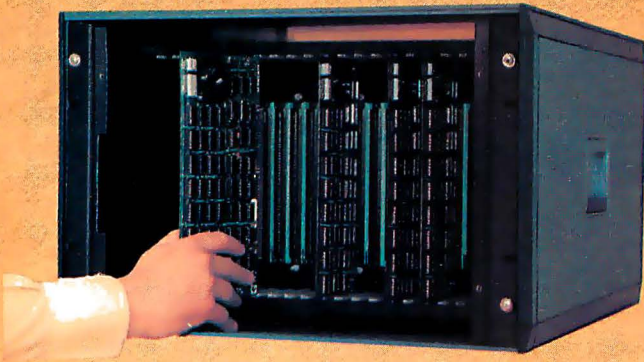

OVER

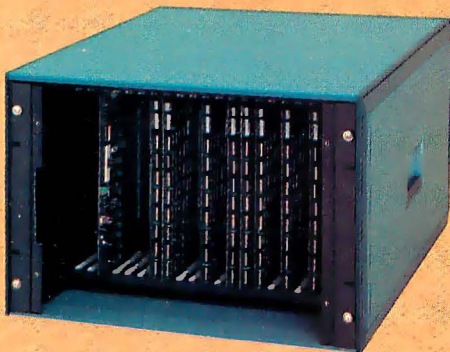

Full-width motherboard has slots for 21 cards.

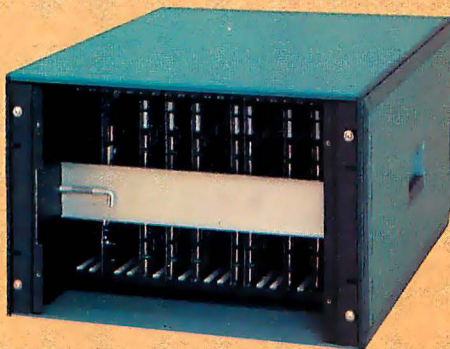

Z-2 is supplied for rack mounting. Attractive bench cabinet shown is also available.



Heavy-duty retainer bar insures that cards won't jostle out of sockets.

That 4 MHz speed cuts running time in half — cuts your waiting time in half. Lets you do more sophisticated work that might not otherwise be practical with a microcomputer.

Z-80 GIVES MORE COMPUTER POWER

The Z-2 uses the powerful Z-80 microprocessor with its 158-instruction set, 19 internal registers, 10 addressing modes, and 16 bit arithmetic operations.

The Z-80 is widely regarded as the standard microprocessor of the future. So you're in the technical fore with the Z-2. But you can also plug in other microprocessor boards if you wish.

BROAD SOFTWARE SUPPORT

Since the Z-2 uses the Z-80, your present 8080 software can be used with the Z-2. In addition, Cromemco also offers software support including a monitor, assembler, and a BASIC interpreter.

STANDARD S-100 BUS

The Z-2 uses the S-100 bus that has become standard in the microcomputer field. Dozens of manufacturers support it with compatible peripherals.

Of course, all Cromemco peripherals such as our 7-channel A/D and D/A converter, our well-known BYTESAVER with its built-in PROM programmer, our color graphics interface, etc., will also plug into the bus.

LOW NOISE

Cromemco engineers have been careful to design the Z-2 for reliable operation at its fast 4 MHz speed. Noise on the motherboard, for example, has been carefully minimized by a unique *ground-plane design* (we call it our 'Blitz Bus™'). With this bus you won't get erratic operation due to ground current noise.

RACK OR CABINET MOUNTING

The basic Z-2 is supplied in a black-anodized metal case for mounting in a standard 19-inch relay rack. A high-quality stylized bench cabinet in an attractive blue color is also available.

KIT OR ASSEMBLED

You can get the Z-2 either kit or assembled. The kit includes the Z-2 for rack mounting, the Cromemco 4 MHz microprocessor card, full-length 21-card-slot motherboard, power supply, one card socket and card-guide set, and front panel.

The assembled Z-2 includes the above as well as all 21 sockets and card guides and a cooling fan.

LOW, LOW PRICE

All who've seen the Z-2 have been surprised and impressed with its low price.

You'll be impressed, too, with its technical excellence and quality.

So see it right away at your computer store — or order now directly from the factory.

The sooner you put this advanced computer to work for you, the sooner you'll be solving problems and saving time/money.

Z-2 Computer System kit (Model Z-2K) \$595.
 Z-2 Computer System assembled
 (Model Z-2W) \$995.



Cromemco

i n c o r p o r a t e d

Specialists in computers and peripherals

2432 CHARLESTON RD., MOUNTAIN VIEW, CA 94043 • (415) 964-7400

In the Queue

BYTE

MARCH 1977

Volume 2

Number 3

Foreground

- 70 SIMPLIFIED OMEGA RECEIVER DETAILS
Hardware—Burhans
- 88 INEXPENSIVE JOYSTICK INTERFACES
Hardware—Buschbach
- 106 FLIGHTS OF FANCY WITH THE ENTERPRISE
Games Software—Price
- 122 MULTIPLEX YOUR DIGITAL LED DISPLAYS
Hardware—Hogenson

Background

- 9 GIVE YOUR MICRO SOME MUSCLES
Hardware—Grappel
- 18 REVIEW OF THE SWTPC PR-40 ALPHANUMERIC PRINTER
Product Description—Kay
- 26 CASSETTE TRANSPORTS FOR THE "ROLL YOUR OWN" HOBBYIST
Cassette Transports—Freeman
- 38 THE DIGITAL CASSETTE SUBSYSTEM, Part 2
Hardware—Bremeir-Rampil
- 50 WHAT'S INVOLVED IN KIT BUILDING?
Construction—Frenzel
- 114 TRY THIS COMPUTER ON FOR SIZE
Review—Ciarcia

Nucleus

- 4 In This BYTE
- 13 PAPERBYTES™ Forum
- 14 BYTE Goes International
- 16 Letters
- 36 A 6502 Op Code Table
- 98, 104 What's New?
- 102 Technical Forum
- 113 Positively Baker Street
- 130 Another PAPERBYTES™ Test
- 136, 146 BYTE's Bits
- 137 BYTE's Bugs
- 140 Classified Ads
- 142 Clubs, Newsletters
- 160 BOMB
- 160 Reader Service

BYTE magazine is published monthly by BYTE Publications, Inc, 70 Main St, Peterborough, New Hampshire 03458. Subscription rates are \$12 for one year, \$22 for two years, \$30 for three years in North America. Second class postage paid at Peterborough New Hampshire 03458 and at additional mailing offices. Phone 603-924-7217. Entire contents copyright © 1977 BYTE Publications, Inc, Peterborough NH 03458. All rights reserved. Address editorial correspondence to Editor, BYTE, 70 Main St, Peterborough NH 03458. Opinions expressed by authors are not necessarily those of BYTE magazine.

PUBLISHERS

Virginia Peschke
Manfred Peschke

EDITOR

Carl T Helmers Jr

PRODUCTION MANAGER

Judith Havey

CIRCULATION MANAGER

Manfred Peschke

ASSISTANT PUBLISHER

Debra Boudrieau

CO-OP EDITORS

Scott Morrow

Dan Pagan

PRODUCTION EDITOR

Karen Gregory

CIRCULATION

Kimberly Barbour

Cheryl Hurd

Deborah R Luhrs

Carol Nyland

Deena Zealy

ADVERTISING

Elizabeth Alpaugh

Virginia Peschke

ART

Matthew Arnold

Noreen Bardsley

Mary Jane Frohlich

Lynn Malo

Bill Morello

SPECIAL PRODUCTS

Susan Pearne

Floyd Rehling

TYPOGRAPHY

Custom Marketing Resources Inc

Goodway Graphics

Mary Lavoie

Taimi Woodward

PHOTOGRAPHY

Ed Crabtree

Custom Marketing Resources Inc

PRINTING

The George Banta Company

Custom Marketing Resources Inc

Lennie Cashion

Larry Davis

Jeff Pratt

ASSOCIATES

Bob Baker

Walter Banks

Steve Ciarcia

Dan Fylstra

Portia Isaacson

Harold A Mauch

CLUBS, CLASSIFIED

Peter Travisano

AFFILIATE PUBLISHER

Southeast Asian Editions

John Bannister



page 9

page 26

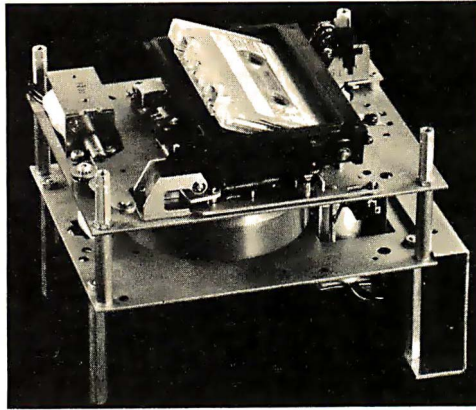

About the Cover

This month's cover is by Sandra D Crandall, Narragansett RI 02882, a first prize winner of BYTE's Computer Art Contest. When she painted her updated "American Gothic," she was completing her BFA in Art at the University of Rhode Island, and as assistant Art Department slide curator, maintained a library of over 40,000 slides. "My fiance is finishing his BS in Computer Science and is an avid BYTE subscriber from the word go," she wrote.

In This BYTE

Many of the possible applications of small computers involve the moving of a mechanical device. One possible way to digitally control these devices is with servomechanisms such as those used in radio controlled model aircraft. In his article, **Give Your Micro Some Muscles**, Robert D Grappel describes how simple it is to interface these devices with your computer to control your own mechanical devices.

Since microprocessors have hit the hobby market, one of the larger difficulties of the computer hacker has been obtaining inexpensive hardware copy capabilities. Southwest Technical Products Corp has introduced a line printer that is the answer to this difficulty. Their inexpensive impact dot matrix printer is described by Gary Kay in his article **A Review of the SWTPC PR-40 Alphanumeric Printer**.

page 88

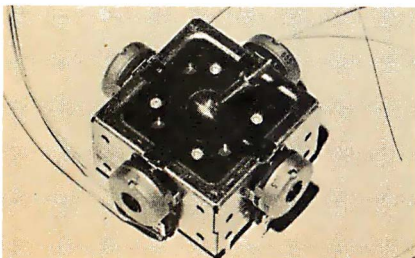

The audio cassette is a kluge similar to paper tape; it works but is inconvenient. The "ideal" cassette system is completely controlled by the computer's commands, the full digital cassette recording facility. In his article on **Cassette Transports for the "Roll Your Own" Hobbyist**, William H Freeman takes a look at three different drives which have potential as mass storage subsystems for the personal computing experimenter.

Last month we began an article on **The Digital Cassette Subsystem**, by Jack Breimeir and Ira Rampil. In this issue, we continue the discussion with part 2, concerning digital data formats and system considerations.

Today's computer hobby world is a kit oriented one. In his article, **Kit Building for the Computer Hobbyist**, Louis E Frenzel sets forth guidelines that allow the inexperienced kit builder, the inexperienced hardware person, or the software hacker who just wants to get the basics, to construct a working computer oriented kit on the first attempt.

Navigation has come a long way since the astrolabe, as exemplified by the Omega system. In this month's BYTE, Ralph W Burhans continues his presentation of the hardware for an inexpensive Omega navigation system with some **Simplified Omega Receiver Details**. (The series concludes with an article on software by Richard J Salter Jr in next month's BYTE.)

To interact with video games or graphic systems, it is often useful to interface devices such as joysticks to the microprocessor. In his article, **An Inexpensive Joystick Interface**, Thomas Buschbach describes one method that will enable you to implement the conversion process in hardware.

Over the years since the demise of the original Star Trek television series, there has been an increasing variety of people enamored with the ideas that the program had to offer. Among these people are personal computing enthusiasts who have turned these ideas into a large variety of computer games. In **Flights of Fancy with the Enterprise**, David Price introduces his own version of the Star Trek theme. His program, though small enough to be played on many microcomputers, allows a wide enough number of variations in play to satisfy even the most frequent users. This program is a must for Trekkies.

Steve Ciarcia owns and uses a Digital Group 8080A system. Read about his experiences and you might want to **Try This Computer on for Size**.

Want 16 digit BCD output for your calculator software? Need an octal display to replace your binary lamps? Read Jim Hogenson's article on how to **Multiplex Your Digital LED Displays** to find out what it takes to make numeric display output hardware.

Introducing Sol Systems

**A complete computer/terminal
concept with all the
standard features, software
and peripheral gear you
want in your
personal computer.**



Sol Systems put it all together. One source for hardware and software. One source for engineered compatibility of computer and peripherals. That's the Sol plan.

Though the microprocessor made the powerful small computer possible, a lot of folks found out early efforts in the marketplace were selling the sizzle a lot more than the steak. After an initial investment of several hundred dollars, you ended up with some nice parts, but no memory of any kind, no I/O devices or interfaces, no display, print-out or software.

The Sol plan ends all that. Processor Technology takes the position that it's far better to be right than first. So let's get down to the Sol no tricks plan.

For \$995 in kit form, the first complete small computer

Standard is a basic word at Processor Technology. The Sol-20 has more standard features than any other small computer we know of. Here's what you get.

8080 microprocessor* 1024 character video display circuitry* 1024 words of static low-power RAM* 1024 words of preprogrammed PROM* a custom, almost sensual 85-key solid-state keyboard* audio cassette interface capable of controlling two recorders at 1200 baud* both parallel and serial standardized interface connectors* a complete power supply* a beautiful case with solid walnut sides* software which includes a preprogrammed Prom personality module and a cassette with Basic-5 language plus two sophisticated computer video games* the ability to work with all S-100 bus (Altair 8800/IMSAI/PTC) products.

There are no surprises. Everything you need to make it work is here. In kit form, nominal assembly time from our fully documented instructions is four to seven evenings.

Or start with the Sol-PC for just \$475

You can begin your Sol system with the all on one board Sol-PC kit. It has all the

memory and interface electronics including video display, keyboard interface, audio cassette interface, all necessary software and the ability to accept the full Processor Technology line of memory and interface modules. Use the Sol-PC as the basis of a microcomputer, low cost CRT terminal or editing terminal

The Sol plan, completely expandable.

By filling the basic main frame with tailor made Processor Technology plug-in PC boards, you can really expand the computing power and flexibility of your Sol-20 Personal Computer.

New items are being announced frequently, but right now, here are some of the things you can add to your Sol-20. The ALS-8 Firmware module is an assembly language operating system to give you the power to develop and run programs. Use it to quickly write, edit, assemble, de-bug and run your own programs. Some say it's the most useful software development on the market today, but modesty prohibits.

And when it comes to add-on memory boards, you've come to the right place. We've probably got more than anyone else. Choose from 2K ROM or 4, 8 or 16K RAM. The PT 2KRO will accept up to eight 1702A or 5203Q erasable, reprogrammable memories (EPROM's) with the ability to store in a non-volatile fashion up to 2048 eight-bit words.

Our read/write memories are the industry standards for high reliability. We know, because we have literally scores of customer letters saying "Your memory modules work and keep on working."

A full line of Sol-20 tailored peripherals

No computer can do the full job without the right set of peripheral gear. PT has

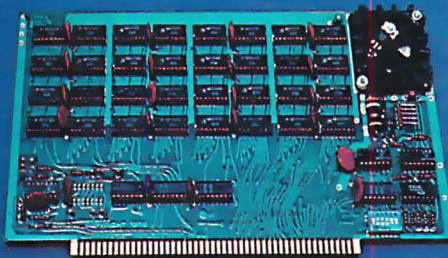
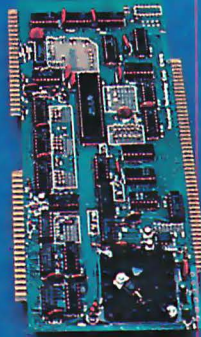
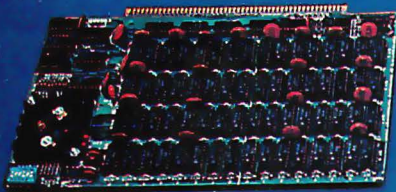
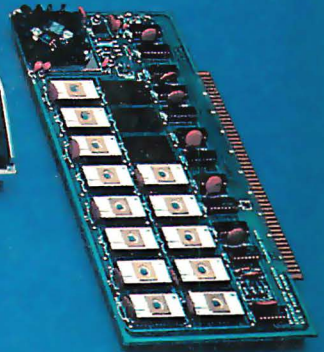
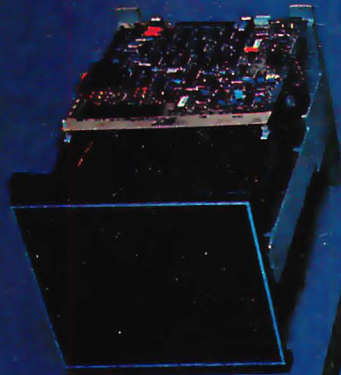

sought out the best manufacturers of peripheral equipment and worked with them to give you a choice of quality so you can get the most out of your Sol-20. Choose from line and serial printers, perforated tape readers and punches, floppy disk memories, black and white or color graphics displays, A/D, D/A converters and more.

Software, the Computer Power Essential

A big part of making the first complete small computer is providing you with a wide range of easy to use, easy to obtain, low cost software. For the Sol-20, we've developed a whole group of offerings. And more are on their way.

Sol Systems Price List

(prices are net, effective Dec. 1, 1976)

SOFTWARE

ITEM with manual	Source	CUTS cassette	Paper tape
BASIC 5 software #2	yes	**	\$19.50
8K BASIC	no	\$29.00	\$37.00
New 8080 Focal	no	\$14.50	N/A
TREK 80 video game	no	\$ 9.50	\$14.50
GAMEPAC 1 video games	no	\$ 9.50	\$14.50
MATHPACK video calculator	yes	\$14.50	\$19.50
ASSEMBLER software #1	yes	\$14.50	\$19.50

**CUTS cassette of BASIC 5 is included FREE with all orders for Sol units or CUTS cassette interfaces. Additional cassettes available for \$14.50.

Sol system owners be sure to note Sol system on your order. These special versions use less code and provide easier loading along with more convenient operation. SOLOS, SOLED and CONSOL all have provision for the special versions.

All Processor Technology software is distributed on an individual sale basis for personal use. No license to copy, duplicate or sell is granted with this sale. Each software package has been copyrighted by Processor Technology and all rights therein are reserved.

Sol Terminal Computers

SOL-PC SINGLE BOARD TERMINAL COMPUTER™

Kit Price

\$475.*

SOL-10 TERMINAL COMPUTER™

Sol-PC with case, power supply and 70 key solid state keyboard. **\$795.***

SOL-20 TERMINAL COMPUTER™

all features of Sol-10 with larger power supply, 85 key solid state keyboard, fan, and five slot expansion backplane. **\$995.***

*Sol prices include CONSOL Personality Module. If SOLED Intelligent Editing Terminal Module or SOLOS Stand-alone Operating System Module is desired instead, add \$100. If ordered separately, personality modules are \$150 each.

Mass Storage Systems

Helios II Disk System™

includes dual PerSci 270 floppy disk drive, cabinet, fan, S-100 bus compatible controller, power supply, system diskette with complete PTDOS software **\$1895 \$2295**

Memory Modules

	Kit	Asmbld.
ALS-8 PROM Resident Assembly Language Operating System	—	\$425
SIM-1 Interpretive Simulator add-on option for ALS-8	—	\$ 95
TXT-2 Text Editing add-on option for ALS-8	—	\$ 95
2KRO Erasable PROM module	\$ 65	\$ 89
4KRA 4096-word Low Power Static RAM	\$159	\$195
8KRA 8192-word Low Power Static RAM	\$295	\$375
16KRA 16384-word Dynamic RAM	—	\$529

Interface modules

3P+S Parallel/Serial I/O module	\$149	\$199
CUTS Computer Users Tape System cassette interface	\$ 87	\$119
VDM-1 Video Display Module	\$199	\$295

See your nearest dealer or contact us directly. Address Processor Technology, 6200B Hollis Street, Emeryville CA 94608, Phone 415/652-8080.



Give Your Micro Some Muscles

Robert D Grappel
148 Wood St
Lexington MA 02173

A lot of proposed microcomputer applications require the computer to control various mechanical devices. Opening and closing valves, moving things, pushing, turning, etc, are not things that computers can do without help. This article describes a surprisingly easy way to turn digital signals into mechanical motion. This will make it easier to design plotters, controllers ... anything that requires motion.

Before I was bitten by the "computer bug," my hobby was building radio controlled aircraft. In trying to solve the problem of transferring the position of the pilot's hand to the position of a control surface on the aircraft, we modelers gradually came to use digital systems. The servomechanisms used in aircraft are very sophisticated devices. They are tiny, less than 3 cubic inches (49 cubic centimeters). They are light, less than 2 ounces (58 grams). They provide up to 4 pounds (1.8 kilograms) of thrust. Each servo requires less than 200 mA of current at 5V. They continue to work over a wide temperature range and in conditions of extreme vibration. It seems to me that such devices would make ideal muscles for our computers. Servos are readily available, and are relatively cheap at around \$25 to \$50. How does one interface an aircraft servo to a micro? Would you believe three connections? Yes, it really is that simple.

You will want to use what is called a

See Sol now

The full line of Processor Technology Sol Computers, systems, software and peripheral equipment is on display now at your nearby Sol store

CALIFORNIA

1514 University Ave.
Berkeley CA 94703
The Byte Shop
2559 South Bascom Ave.
Campbell CA 95008

Byte Shop Computer Store
6041 Greenback Lane
Citrus Heights CA 95610

The Byte Shop
16508 Hawthorne Blvd.
Lawndale CA 90260

The Byte Shop
1063 El Camino Real
Mountain View CA 94040

The Computer Mart
624 West Katella #10
Orange CA 92667

The Byte Shop
2227 El Camino Real
Palo Alto CA 94306

The Computer Store of San Francisco
1093 Mission Street
San Francisco CA 94103

The Byte Shop
155 Blossom Hill Rd.
San Jose, CA 95123

The Byte Shop
509 Francisco Blvd.
San Rafael CA 94901

The Byte Shop
3400 El Camino Real
Santa Clara CA 95051

The Byte Shop
2989 North Main St.
Walnut Creek CA 94596

FLORIDA

Microcomputer Systems, Inc.
144 So. Dale Mabry Hy.
Tampa FL 33609

GEORGIA

Atlanta Computer Mart
5091-B Buford Hwy.
Atlanta GA 30340

ILLINOIS

The Numbers Racket
518 East Green Street
Champaign IL 61820

itty bitty machine co., inc.
1316 Chicago Ave.
Evanston IL 60201

INDIANA

The Data Domain
406 So. College Ave.
Bloomington IN 47401

KANSAS

The Computer Hut
521 N. Hillside
Wichita, KS 67214

MICHIGAN

The Computer Store of Ann Arbor
310 East Washington
Ann Arbor MI 48104

General Computer Store
2011 Livernois
Troy MI 48084

NEW JERSEY

The Computer Mart of New Jersey
501 Route 27
Iselin NJ 08830

Hoboken Computer Works
No. 20 Hudson Place
Hoboken NJ 07030

NEW YORK

Audio Design Electronics
487 Broadway, Ste. 512
New York NY 10013

The Computer Corner
200 Hamilton Ave.
White Plains NY 10601

The Computer Mart of Long Island
2072 Front Street
East Meadow, L.I. NY 11554

The Computer Mart of New York
314 Fifth Ave.
New York NY 10001
Synchro Sound Enterprises
193-25 Jamaica Ave.
Hollis NY 11423

OREGON

The Real Oregon Computer Co.
205 West 10th Ave.
Eugene OR 97401

Byte Shop Computer Store
2033 S.W. 4th Ave.
Portland OR 97201

OKLAHOMA

High Technology
1020 West Wilshire Blvd.
Oklahoma City OK 73116

RHODE ISLAND

Computer Power, Inc.
M24 Airport Mall
1800 Post Road
Warwick RI 02886

TEXAS

The Micro Store
634 South Central
Expressway
Richardson TX 75080

WASHINGTON

The Retail Computer Store
410 N.E. 72nd
Seattle, WA 98115

WASHINGTON, D.C. area

Media Reactions Inc.
11303 South Shore Dr.
Reston VA 22090

WISCONSIN

The Milwaukee Computer Store
6916 W. North Ave.
Milwaukee WI 53213

CANADA

The Computer Place
186 Queen St. West
Toronto, Ontario M5V 1Z1

Trintronics
160 Elgin St.
Place Bell Canada
Ottawa, Ontario K2P 2C4

First Canadian Computer Store Ltd.
44 Eglinton Ave. West
Toronto, Ontario M4R 1A1

Pacific Computer Store
4509-11 Rupert St.
Vancouver, B.C. V5R 2J4

 Processor Technology



Figure 1: Timing diagram of the waveform that is needed to drive the servomechanism. The pulses are from 16 to 20 ms apart in time, and have a pulse width of 1 to 2 ms. This type of timing can be accomplished using your computer's internal clock as a reference in timing loops, or through a programmable real time clock.

three wire servo which is the modern type unit. These run on regulated 5 V supplies. That takes care of two of the necessary connections. The third lead is the input signal. This is a TTL compatible signal, which can be driven from one bit of a typical output port. We will use software to generate the proper waveform at this bit. Since each servo requires only one output bit, a typical byte port can drive up to 8 servos.

Servos are really pulse width feedback

```

LUCN B1 B2 B2
2001      >      ORG $2001
2001      >> PROGRAM TO TEST MODEL AIRPLANE SERVO
2001      >> WRITTEN BY CARL HELMERS 12/8/76
2001      >> ASSEMBLED WITH JACK EMMERICH'S ASSEMBLER
2001      >> ILLUSTRATION FOR ROBERT GRAPPEL'S ARTICLE
2001      >>
2001      >> -----DATA DEFINITIONS-----
0151      >PIAC EQU $151      PIA CONTROL REGISTER ADDRESS
0150      >PIAD EQU $150      PIA DATA/DIRECTION REGISTER ADDRESS
0138      >MILI EQU $138      MILI(B)  MILLISECOND DELAY ROUTINE
2001 00 00 >DATA FDB 0          SERVO POSITION DATA REGISTER
014F      >LAMZ EQU $14F      LAMPS
2003      >>
2003      >> -----PROGRAM-----
2003      >> * MAIN ENTRY POINT
2003 7F 01 51 >ENTY CLR PIAC      SET UP THE PIA
2006 7F 01 50 >      CLR PIAD          WITH ALL DATA
2009 73 01 50 >      CUM PIAD            BITS OUTPUT
200C R6 04 >      LDAA #4
200E B7 01 51 >      STAA PIAC
2011 7F 01 50 >      CLR PIAD          POSITIVE GOING PULSE SETUP
2014      >>
2014      >> * MAIN EXECUTION LOOP
2014      >>
2014      >> * PULSE OUTPUT, MINIMUM 1 MS
2014 73 01 50 >PULS CUM PIAD      START PULSE
2017 C6 01 >      LDAB #1          WAIT ONE
2019 BD 01 3H >      JSR MILI          MILLISECOND
201C B6 20 01 >      LDAA DATA      ---
201F 4A >PULI DECA          VARIABLE DELAY
2020 26 FD >      BNE PULI
2022 73 01 50 >      CUM PIAD          END THE PULSE
2025 C6 FA >      LDAB #250      ---
2027 BD 01 38 >      JSR MILI          250 MS INTERPULSE DELAY
202A 7C 20 01 >      INC DATA
202D H6 20 01 >      LDAA DATA
2030 B7 01 4F >      STAA LAMZ
2033 20 DF >      BRA PULS
2035      >> END

```

*** END - UNRESOLVED ITEMS:

*** SYMBOLS:

DATA 2001 ENTY 2003 LAMZ 014F MILI 0138 PIAC 0151
PIAD 0150 PULI 201F PULS 2014 #

Notes on Trying Robert's Idea for Muscles by Carl Helmers, editor

Using the servo we bought to take the picture of photo 1, I wrote the program shown in this listing to illustrate the operation and test out the characteristics of the device. The program is written for my homebrew 6800 system, which has parallel interface ports at hexadecimal addresses 150 to 157 in memory address space. The PIA port at locations 150 and 151 was used for this experiment, with some binary indicator lamps at location 14F used to tell what the current state of the command parameter was. This program uses a subroutine in my monitor called MILI which is a timing loop returning to the calling point 1 millisecond after entry. The interpulse space was arbitrarily set at 250 ms (it worked) in order to allow observation of what was happening

Continued on page 34

Photo 1: A typical model aircraft servo, which we purchased at a local hobby shop in Greenville NH. The price of this unit was about \$45, and the only documentation we could find on it, the catalog, said it could exert 5 pounds of force, presumably at the limit of the lever arm provided by the standard bell cranks and connection wheels which came with it. We took it apart after photography and found a gearbox with several gears, the motor, potentiometer slaved to the main output shaft, and electronics. Although the printed circuit board internal to the device had "made in Japan" marked on it, the actual integrated circuit was clearly a result of international trade — it was marked "Texas Instruments." After reassembly, it was tried out with the program shown in the box accompanying this article, using a PIA port at address location 0150 (hexadecimal).



Computer music hits the big time with hardware controlled waveforms, tone, volume and 9 octave levels . . . plus a new high level music language!



Now you can create the real sounds of your favorite instrument, compose your own music, play your favorite sounds or do in-depth musical research on your Altair or IMSAI S-100 bus computer.

The brand new SB-1 Music Board can generate complex waveforms easily because attack and sustain reside in hardware, not software. Since you can store several waveforms in memory, your computer will play more than one instrument. The new high-level language developed especially for the SB-1 allows you to easily input the notes just as you would read them and adjust the sounds by controlling the waveform. The output of the SB-1 provides a 2-pin connector for low-impedance output, or approximately 1 volt RMS with accuracy better than 1/2% for one octave of the tempered scale. Multiple sounds can be generated with additional boards.

Put versatility and music into your computer today. Contact your local computer hobbyist store or write for complete details.



A division of Solid State Music

2102A Walsh Avenue
Santa Clara, CA 95050
(408) 246-2707

Hear us at the First West Coast Computer Faire in San Francisco, April 16th and 17th, Booths 323 and 325.

We're the blue boards.

units. The input is a pulse with a carefully controlled width. The servo contains an electric motor, a gear train, a feedback potentiometer connected to the gearing, and some fairly sophisticated electronics. In modern servos, all the electronics is contained in a custom integrated circuit. The circuit generates an internal pulse every time it receives an input pulse. The internal pulse width is controlled by the feedback pot. The circuit then compares the pulse widths. If they match, then no current goes to the motor. If they do not match, then current is fed to the motor and it drives the mechanics, together with the feedback pot, in the appropriate direction until the pulse widths again match. By feeding pulses in a rapid stream into the servo, it will appear to track the varying pulse width.

Just about every servo sold for use in model aircraft expects pulse widths varying between 1 and 2 ms. Most servos use positive going pulses, but there are a few servos around which require negative going pulses. The pulses should be repeated every 16 to 20 ms. The repetition frequency is not critical. The servo will run from extreme to extreme in about 0.5 s. To drive the servo, one then needs to generate a waveform like that in figure 1. This can be done with timing loops, interrupts or programmable timers. Even the slowest processor can handle this task.

Model boats, and some aircraft, use electric power plants. The same type of controls can be used to vary the speed and direction of electric motors. For readers interested in controlling motors, and other high power devices, I would recommend the circuits published in *RCM*, (Radio Control Modeler). Page 166 in the April 1976 issue shows a circuit using the integrated circuit from a servo and two external transistors to control a 20 A motor from full stop to full speed. Page 12 of the September 1976 issue shows a similar circuit which has the added feature of forward and reverse control. Circuits like these can also control other loads, like lights or heaters. This is fully proportional control, not just on and off.

Now there is no excuse for not building that robot you were thinking about. You can use servos to control your tape cassettes by pushing the buttons under computer control. Using two servos, one in the X direction and another in the Y direction, a pen plotter can give your computer a hard copy graphics capability. There are hundreds of exciting possibilities. I hope to read of some of them in these pages soon. ■

Now. ■ THE PERFECT MICROCOMPUTER

VECTOR 1



It's a two touch affair

VECTOR 1 is based on the 8080A Microprocessor and S-100 Bus -

EASY TO ASSEMBLE, EASY TO ACCESSORIZE, EASY TO BUY AND VERY EASY TO OPERATE.



VECTOR GRAPHIC INC. ^{T.M.}

717 LAKEFIELD ROAD, SUITE F
WESTLAKE VILLAGE, CA 91361 • (805) 497-0733

Now.

THE PERFECT MICROCOMPUTER

VECTOR 1

DEALERS

EAST COAST

Computer Mart of New York, Inc.
314 Fifth Avenue
New York, New York 10001
212-279-1048

Computer Mart of Long Island
2072 Front Street
East Meadow, New York, New York 11554
516-794-0510

The Computer Mart of New Jersey
501 Route 27
Iselin, New Jersey
201-283-0600

The Computer Mart
1097 Lexington
Waltham, Massachusetts 02154
617-899-4540

WEST COAST

Byte Shop of Westminster
14300 Beach Blvd.
Westminster, Ca. 92683
714-894-9131

Byte Shop
18424 Ventura Blvd.
Tarzana, Ca. 91356
213-343-3919

Byte Shop
Palm Plaza
Thousand Oaks, Ca. 91360
805-497-9595

Byte Shop
2559 S. Bascom Ave.
Campbell, Calif. 95008

Kentucky Fried Computers
2465 Fourth Street
Berkeley, Ca. 94710
415-549-0858

MIDWEST

DATA DOMAIN - the Personal Computer Stores

INDIANA

(Home office)
406 S. College Ave.
Bloomington 47401
812-334-3607

7027 Michigan Rd.
Indianapolis 46268
317-251-3139

219 Columbia
West Lafayette 47905
(Opening early December)

ILLINOIS

(itty bitty machine co., inc.)
1316 Chicago Ave.
Evanston 60201
312-328-6800

42 W. Roosevelt
Lombard 60148

KENTUCKY

506 1/2 Euclid Avenue
Lexington
606-233-3346

3028 Hunsinger Lane
Louisville 40220
502-456-5242

WISCONSIN

2221 E. Capitol
Shorewood 53211
414-961-2430

TEXAS

The Micro Store
634 S. Central Expressway
Richardson, Texas



VECTOR GRAPHIC INC. ^{TM.}

717 LAKEFIELD RD., • SUITE F
WESTLAKE VILLAGE, CA 91361

PAPERBYTESTM Forum

Machine readable printed software is an exciting subject. Numerous comments have been received from various individuals regarding the idea of machine readable printed software as described in the November and December 1976 issues of BYTE. These are excerpts from various letters which often covered other topics as well:

Multiple Synch Characters . . .

Several people have suggested that the format should contain multiple SYN characters. Here are a couple of examples of the comments:

I have a few comments on the proposed standard for machine readable printed data. (My forte is not building bar code readers, but I do have some experience in high speed data transmission.) In the proposed frame layout I would suggest duplicating the SYNCH character at least one more time, and possibly a couple more times. The reasoning is that even if the timing marks are included (which I don't think were in the December samples) the adaptive algorithm must establish "bit synch" to extract the bits correctly, and then it must establish "character synch" to insure it has gotten the character boundaries correct. In data transmission schemes, usually two or four synchs are used depending on whether the synch pattern is to establish only character synch or both character and bit synch. The modulation schemes you have presented seem to have enough transitions in them to get bit synch, so four synchs probably aren't needed. But the algorithm would be a lot more sure of what is going on if there were at least two synchs: one to get synched, and one to check the synch. I think this is particularly important considering the data following the synch is the checksum. Slop or jitter from the startup of the human hand could be particularly damaging here. A few extra synchs thrown in could solve that potential problem.

Maybe I am trying to make this all too complicated, but my background is one of insuring robustness in protocols. The bar code wand reader experts probably have a better feeling than I for things like this.

Mike O'Dell
University of Oklahoma
Information and Computing Sciences
601 Elm, Rm 926
Norman OK 73069

Another reader suggested putting a second SYN character at the end of the frame in order to allow scanning in either direction, a sentiment which was echoed by Tom Pittman of Tiny BASIC fame. But using the sparse format shown in the examples in this issue [or format (c) of December BYTE, page 17], the frame capacity is only about 26 to

32 data bytes, depending on length, so a 3 to 4% penalty in capacity is required. Also, the main advantage is to allow sweeps in both directions, which for manual scanning may not be particularly important since the rhythm of operation has to be interrupted by repositioning the guide straightedge between each swipe.

Printed, Machine Readable Braille?

Totally unrelated to our bar code representation for data, but nevertheless interesting, is this letter from C R Conkling Jr, and his accompanying sample.

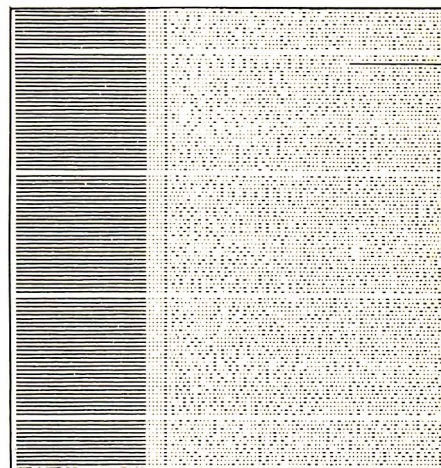

The sample is a short segment of the text, reproduced here twice the original size, which was a test occupying two sides of a letter size sheet of enameled paper.

I was interested in your thoughts on using ink print to transmit digital information. I have enclosed an ink printed sheet of paper which was printed using standard offset methods. The paper contains a complete pocket paperback size book. I must say, however, that it is in grade 2 Braille which uses contractions, as in speed writing. The Braille code is a 6 bit code, and the paper is encoded to drive a mechanical Braille cell to reproduce the data.

Why it was done is a long story. Why it was never completed is even longer. One of the reasons that it was never completed was that we had no luck

Continued on page 82

BYTE Goes International

by Carl Helmers

Accompanying this editorial is a letter from an Australian reader, Kevin C Barnes of Five Dock, New South Wales. He's writing on the conditions of the small computer person in Australia circa September 1976. We held onto the letter until it was possible to announce an arrangement which should help promote and build an indigenous small computer industry in Australia: the new Far East Asian editions of BYTE magazine.

When BYTE first began circulation, an

electronics engineering consultant named John Bannister, a native of Sydney, Australia, subscribed nearly instantaneously when he heard about it from an American friend. But he soon ran into a problem which plagues all individuals on the end of a long international supply chain — it takes time and patience to await BYTE (or any US goods, for that matter) in Australia, which is

Continued on page 62

Are Logic States Inverted Down Under?

Here are just a few notes that might be of interest to your readers about conditions in Australia. Interest in computing is just about to happen down here. Both national electronics magazines, *Electronics Australia* and *Electronics Today International* have just (July 1976 issue) started to talk about microprocessors. They have started by reviewing the different evaluation boards available. But neither magazine has published any construction articles as yet on microprocessor based microcomputers. (EA did design and publish an 8 bit processor back in the end of 1974 and beginning of 1975, but it was a serial processor which did not gain the popularity of the present microprocessor systems. That processor, the EDUC-8, was built using TTL MSI and SSI chips and had a limited memory of 256 locations. In fact EA was beaten to the honor of being the first to publish a computer plan by only a few weeks by *Radio Electronics'* publication of the Mark 8.)

Commercial interests now have a number of American designed and built systems offered for sale, but unfortunately these people do not yet carry much stock. MITS equipment is offered down here by a company called WHK of Melbourne, and the proprietor has published a rather impressive catalog with all the MITS hardware and software listed. JOLT is also being advertised as well, although mainly through the trade journals. EPA's Micro 68 also has been offered for sale and the agent has at least one in stock which he is willing to lend to people to look at and play with.

I and three other people have formed a small club and have three systems operating, using the 6800, 8080 and the SC/MP chips. They have been built around evaluation boards. We also have an ASR-33 and ASR-38 Teletype and

our big project at the moment is a floppy disk. Our small project of the moment is a PROM programmer to program 1702s. In my conversations with various integrated circuit manufacturing company representatives, I've gained information that a good proportion of the sales here have been to individuals, not companies, and that many boards bought by companies have been for individuals within the companies and not for particular company projects [*standard practice in the US, too . . . CH*].

Also very annoying is the rather high price markup on the hardware by the time it reaches Australia. The *Intel 8080 Microprocessor System User's Manual* for instance has sold for \$20 even though it is marked \$5, while the Altair 8800A sells for \$619 Australian (\$740 US currently) for the basic kit with no extra boards. Well, I hope this has been of interest.

Kevin C Barnes
71 Barnstaple Rd
Five Dock
New South Wales 2046
AUSTRALIA

Thanks for your comments, Kevin. By the time this letter is in print, it will be part of the third issue of our new Australian English language edition of BYTE, so with any luck you'll soon start to find some increases in personal computing activity in your vicinity. Until there is local manufacture, there is no way you can beat the price penalty, as nearly as I can project: Shipping costs time and money. When a product is dear, whether through distance or natural scarcity, Adam Smith and Co long ago predicted the price would rise. I understand from John Bannister, however, that at least you don't have to pay an exorbitant import tariff as our Canadian friends do.

Experience the excitement of owning the world's finest *personal* computer – IMSAI 8080

Waiting for you – all the incredible performance and power of the IMSAI 8080. And at a price you would normally pay for a fine home music system.

Introduced less than two years ago, the IMSAI 8080 is sold worldwide and acknowledged as the finest *personal* computer available.

WORLD OF USES

The IMSAI 8080 is a superbly engineered, quality computer. It is versatile, expandable and powerful, putting literally hundreds of

applications and uses at your fingertips. Imagine sitting at your desk and enjoying interaction with your IMSAI 8080! Press the on switch and you're ready for game playing, research, education, business applications, or for laboratory instrument control. It has all the power you need, and more, to make your application ideas come alive.

GROWS WITH YOU

The IMSAI 8080 is designed for many years of pleasure. With its open-chassis engineering you can expand your system by adding peripherals and interfaces. The 22-slots and 28 amp power supply mean that you can plug-in today's, plus *tomorrow's* modules.

Right now you can add a module for displaying color graphics and characters on TV; a ready-to-use keyboard; small and large printers, and a single interface that lets you attach multiple devices including a cassette tape recorder. Expect the latest, exciting equipment from IMSAI. We are committed to leadership in this expanding technology.

EASY TO PROGRAM

With our BASIC language you can operate the IMSAI 8080 quickly and easily. Technically knowledgeable? Use our assembly language to develop sophisticated and unique software.

If you're thinking personal computer,
treat yourself to the very best –
IMSAI 8080

Send for free four-color brochure
or \$1 for catalog. Call or write for
name of nearest dealer.



IMSAI 8080

IMSAI

IMSAI Manufacturing Corporation
14860 Wicks Blvd.
San Leandro, CA 94577
(415) 483-2093
TWX 910-366 7287

European Distributor
Harper Industry Products, Ltd.
6079 Spremlingen 2
West Germany

Letters

8080 TRICKS AND FAST OPTICS FOR ISOLATION

In the November 1976 letters column, reader Bennett asked for an easy way to do an arithmetic shift right using the 8080. Try RLC, RAR, RAR; only three bytes, and the carry bit ends up the same as with SRA A on the Z80.

By the way, if anyone wants to try an optically coupled video interface to a television, look at HP's 5082-4360 optically coupled logic gate. It's rated for 10,000 bits per second and costs \$6.30 in unit quantity. Cheaper optical couplers can handle sync and, if necessary, an on/off control, but the HP device is the first one I've seen that looks fast enough to handle video frequencies. Using a separate device for sync avoids critical biasing adjustments to make a single device operate in the linear mode. With separate devices, the video and sync mixer goes on the output side of the devices. Frequency response can go down to DC if you can avoid upsetting the television's video stage bias without using a DC blocking capacitor.

Robert F Miles
242 Abingdon Rd NW
Lenoir NC 28645

OOPS... SUPPLIES GONE

After reading the "An Item of Interest" article in the September issue of BYTE (page 100), I wrote to SWTPC for the June 1976 newsletter. But the newsletter is not in print anymore.

Is there any way I could get a used or old June 1976 newsletter? Please respond.

Robert Leong
705 N Linden Dr
Beverly Hills CA 90210

WANTED: ELIZA FOR THE SMALL COMPUTER

Many years ago I had a dialog (my first online experience!) with a computer that conversed like a psychiatrist, selecting phrases from my input and feeding them back in new context or, if nothing good suggested itself, injecting a random phrase such as "how did you feel about your father?". It was called the ELIZA program, because it learned from its input. According to one article I have read, it was originated at MIT.

Now, after considerable timesharing, I am a subscriber to BYTE and am buying an Altair 8800a on the Kit-a-Month plan. Is anyone in BYTEland familiar with the software for ELIZA? In particular, does anyone know of a ver-

sion suitable for small machines? I'll try to reinvent it if I must, but it seems silly to do so.

John P Aurelius
2568 10th Av W
Seattle WA 98119

ELIZA is a program created by Joseph Weizenbaum at Massachusetts Institute of Technology, which has since spread somewhat widely - in ways not necessarily consistent with its creator's goals. See BYTE's review of Weizenbaum's book, Computer Power and Human Reason, on page 11, January 1977. The book is highly recommended reading for any intellectual. As to whether detail implementations of ELIZA style programs can be found, maybe a reader with academic connections can enlighten us.

THAT'S THE RIGHT IDEA...

I'd like to give my support to Charles Wortell's entry to the Programming Quizzes column [December 1976, page 132]. A few months ago I thought of presetting memory of my 6800 system to SWI (hexadecimal 3F) to catch wayward programs. I'd like to suggest the following to anyone considering a ROM operating system for a 6800: I've replaced the MIKBUG monitor in my SWTPC 6800 with a PROM monitor that initializes memory to SWI. This is only done on power up reset and not on subsequent resets.

I've changed all interrupt vectors to addresses in the processor board RAM. This allows faster interrupt service and frees the SWI for alternate uses. As an added bonus an unexpected interrupt from IO will cause a register print just like SWI.

I'd welcome correspondence from readers considering this and other routines I included in my monitor.

Leo Taylor
18 Ridge Ct W, Apt 21C
West Haven CT 06516

You've got the right idea with respect to customizing and extending monitors. I've done a similar thing in my own machine by writing a monitor program much more capable than MIKBUG. How'd you like to start a 6800 systems programming special interest group?... CH

ALTAIR WORD PROCESSING NEEDED

I am interested in using my Altair 8800 to produce clean letters and reports from text entered through a keyboard with editing capabilities. Is there anyone out there who has an Altair compatible software package who can help me?

Also I'd like to inform you that we have formed a Stony Brook Homebrew Computer Club, which is both hardware and software oriented. We have friendly

and informal meetings and access to various simulators and cross-assemblers on the school computer. Members have their own systems to demonstrate and discuss (8080 and 6800).

Ludwig Braun
Professor of Engineering
State University of NY at Stony Brook
Stony Brook NY 11794

Text editing is one area where we expect to use our office Altair, among other things. Try writing in 6 months or a year if you haven't found a source by then.

YE OLDE BOARD SWITCH MANOEUVRE

The following is a simple fix I found for a crashing Altair 8800. The symptom was apparent false jumps when loading and operating 12 K BASIC for a few minutes. These errors wiped out parts of the loaded software, outputting "syntax" errors, garbage or nothing. The fix was to move the processor card to the center of the case (near the fan), away from other boards, and to tape (double back sticky) an aluminum foil (~1 x 2 inch) heat sink (convection cooled) onto the SN74123. No problems have occurred since.

Dr F R Ruckdeschel
Principal Scientist
Xerox Corp
PCDD/P&MS/EDPA
800 Phillips Rd
Bldg 129
Webster NY 14580

WANTED - 6502 USERS

I would like to say that I enjoy your magazine very much, and look forward to it every month. It always seems to have the articles I am looking for, and they are always entertaining.

I am presently bringing up a 6502 on an OSI superboard and am interested in speaking to anyone with a micro, especially a 650x series computer. If anyone has a monitor that they think is really great, or at least perfect, please give me a call or drop me a line. My phone number is (613) 692-3786. Ask for Kevin.

Kevin Szabo
Box 86, Hillcrest Dr
RR 1, Manotick, Ontario
CANADA K0A 2N0

PAGING WITH AN 1802

First of all, thanks for coming up with a computer magazine for the experimenter just when I needed it.

In regards to the editorial "The Address Space Saturation Problem" by Carl Helmers in your November 1976 issue, page 16, I would like to make a suggestion. The RCA Cosmac 1802 micro-processor, which was used in the recent

Continued on page 94

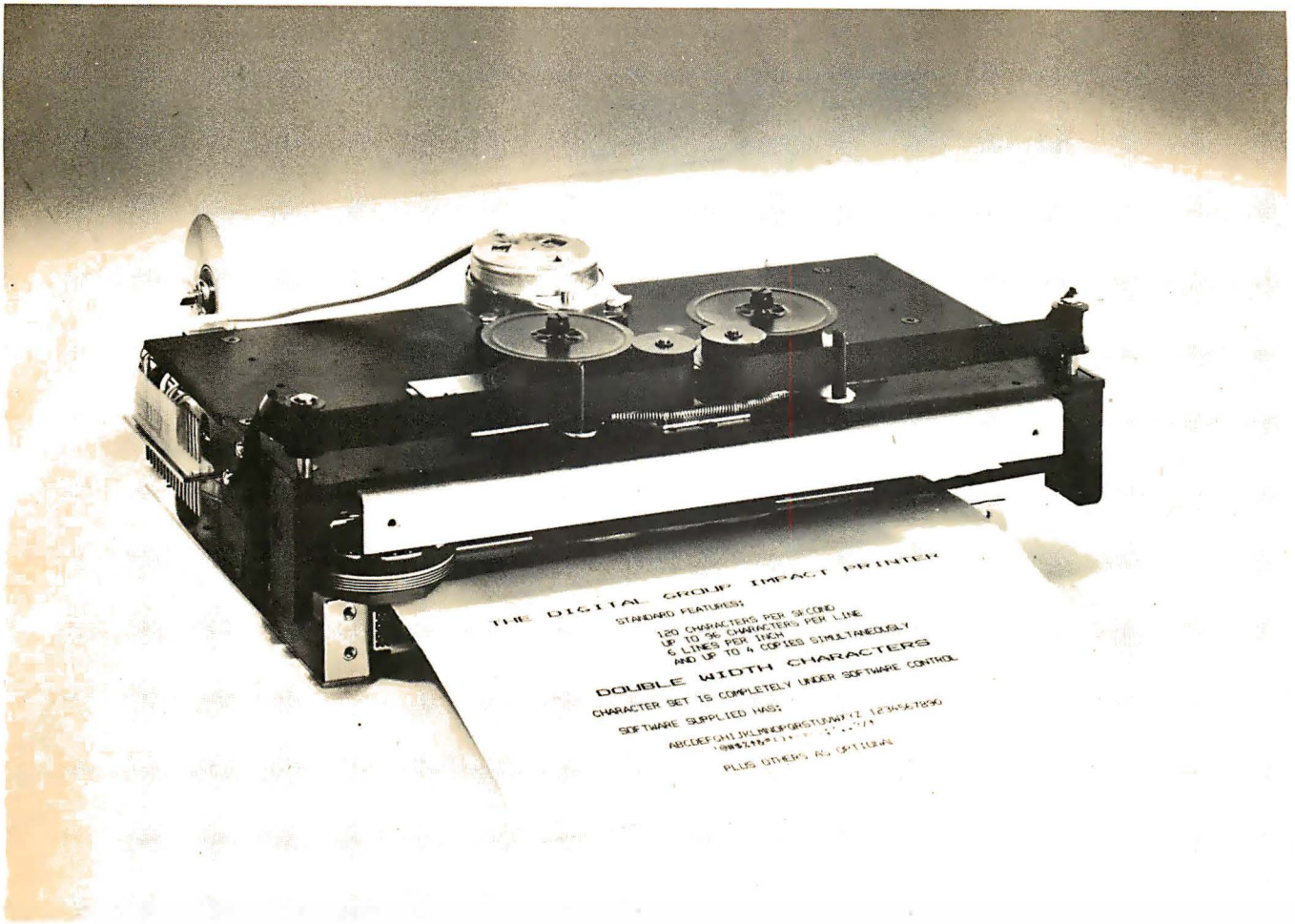

Print Your Heart Out.

With help from the Digital Group, naturally.

Now, that small computer system you own or have been considering for personal or business use suddenly becomes a lot more usable—with the addition of a full-size *impact* printer from the Digital Group. A printer designed for small computers that need big output (like yours).

With the Digital Group printer, you can print your heart out...and it won't cost an arm and a leg. The Digital Group printer is available for less than \$500. That's right—\$500.

There are lots of capabilities and outstanding features of the Digital Group printer...and (as always) the best news is our price. Kit prices start as low as \$495 for the printer and interface card. It simply can't be beat.

Find out all the facts about the Digital Group printer now. Just fill in the coupon below or give us a call for the details. We think you'll find a place for our printer in your system ...and in your heart.

Just look at these specifications:

- Fast—120 characters per second
- 96 characters per line
- 12 characters per inch horizontal
- 6 lines per inch
- Makes up to 4 copies simultaneously
- Character set and pitch variable under software control—double width characters, etc.
- 5 x 7 character matrix
- Ribbon has built-in re-inkers for a life of 10,000,000 characters
- Paper can be either a standard 8½-inch roll, fanfold or cut page
- Interfaces to 8-bit parallel ports

the digital group

P.O. Box 6528
Denver, Colorado 80206
(303) 777-7133

Quick. I want to print my heart out.
Send me all the details on your full-size impact printer.

Name _____

Address _____

City/State/Zip _____

Please print.

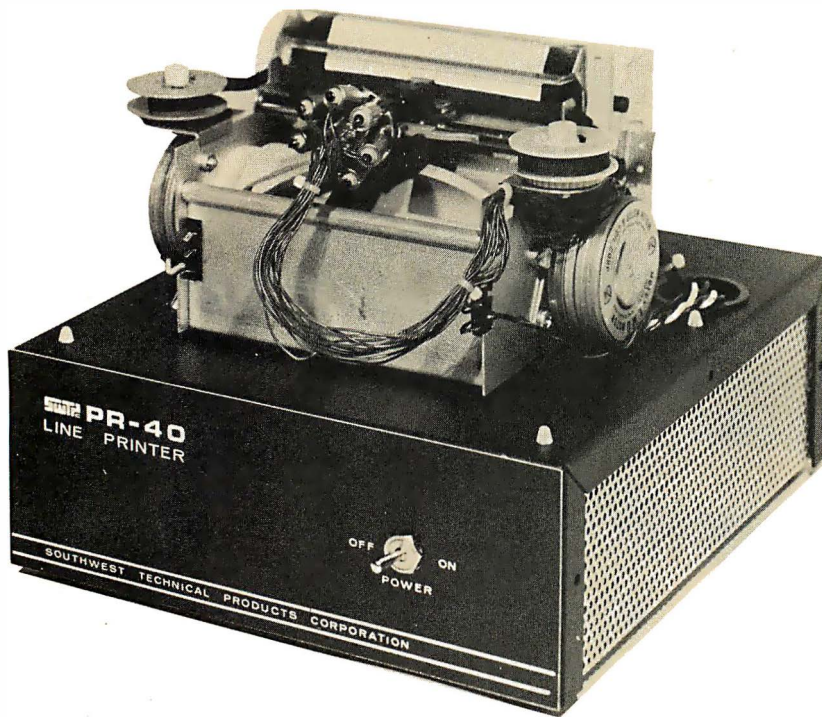

Photo 1: The PR-40 dot matrix printer as assembled from the kit distributed by Southwest Technical Products. The printer is not enclosed in a case but is mounted on a black anodized aluminum chassis with overall dimensions of 9.63 by 10.50 by 8.75 inches (24.45 cm by 26.67 cm by 22.23 cm).

A Review of the SWTPC PR-40 Alphanumeric Printer

Gary Kay
Southwest Technical Products Corp
219 W Rhapsody
San Antonio TX 78216

Ever since the microprocessor's introduction, computer hobbyists everywhere have been searching for a low cost alphanumeric printer. One place the search can stop is at the unit presented here: a 5 by 7 dot matrix impact printer. It prints the 64 character upper case ASCII set with 40 characters per line at a rate of 75 lines per minute on standard 3.875 inch (9.843 cm) rolls of adding machine paper, as shown in figure 1. One complete line is printed at a time from an internal 40 character first in first out buffer memory. Printing takes place either on receipt of a carriage return or automatically whenever the line buffer memory is filled.

The printer can accept character data as fast as one character per microsecond (until

the buffer is full) or as slow as you wish to send it. The printer's seven parallel data lines are TTL compatible and may be enabled by a single data ready control line or by separate data ready and data accepted handshake control lines. This universal approach makes the printer compatible with all computer and terminal systems having an eight bit parallel interface port; including, of course, the SWTPC 6800 and MITS Altair 8800 computer systems.

The printer mechanism is attached to a black anodized aluminum chassis with front trim panel which houses the circuitry including its own 120 or 240 VAC 50 to 60 Hz power supply circuit shown in figure 2, making the printer's overall dimensions 9.625 by 10.50 by 8.75 inches (24.45 by 26.67 by 22.23 cm).

The Mechanics

The entire design, shown in photo 2, is based on a simple and reliable print mechanism intended originally for point of sale

A Printer Testing Program

The printer diagnostic program of listing 1 has been written to test and debug the SWTPC PR-40 printer when it has been interfaced to the SWTPC 6800 computer system through one of the MP L parallel interface boards. It is assumed that before loading this program, the rest of the system is functioning normally with no problems. The program itself uses 60 words and is loaded within the 128 word programmable memory used by the MIKBUG® operating system on the MP A microprocessor and system board. A program may reside in external programmable memory simultaneously with the diagnostic loaded within the 128 word programmable memory, or the diagnostic may be run with no MP M memory boards installed on the system at all. The diagnostic may be loaded either from tape or instruction by instruction using MIKBUG starting from hexadecimal address A014 through A024 and then from hexadecimal address A048 through A072. The address of the MP L parallel interface board feeding the printer must be set using MIKBUG to load the hexadecimal address of the selected port into hexadeci-

mal memory locations A002 and A003 with the most significant byte going into A002 and the least significant byte going into A003. The starting address locations of the interface ports are given in table 1.

Since the program counter is set when the program is initially loaded, the diagnostic is initiated as described in the "go to user's program" section of Engineering Note 100. Once initiated, the program can be stopped only by depressing the reset button. The program may then be restarted after resetting the program counter to hexadecimal A04A as described in the "display contents of processor registers function" section of Engineering Note 100.

The diagnostic works by sending out an ASCII carriage return, hexadecimal OD, followed by hexadecimal ASCII characters 21 through 3F followed by another carriage return OD, followed by hexadecimal ASCII characters 40 through 5E inclusive, repeating itself until stopped with the reset switch.

Each character is output to the printer by first storing the ASCII character's bits 0 through 6 on output lines 00 through 06 of the selected MP L

parallel interface port, then bringing the normally high data ready line low via interface output control line C2 for at least 1 μ s, then returning the line high again. The data must be held stable on the interface output lines, however, until the printer acknowledges data receipt by bringing its normally high data accepted line momentarily low and then high again. This latter low to high transition signifies that the printer has accepted the character. The MP L control line C1 fed by this line has been programmed to see the low to high data accepted transition and responds by allowing the program to output the next sequential ASCII character.

To set the printer's line width adjustment, you should use MIKBUG to change the data in hexadecimal memory locations A056 and A065 from 0D to 00. This will eliminate the transmitted carriage returns and force the printer to print a full 40 column line. The line width control should then be adjusted for symmetrical margins. The characters will still be printed sequentially but will not be identical from line to line.

Do not operate the printer more than a minute or so while running this diagnostic. Continuous printing of full length lines with no spacing between characters overheats the solenoids on the print mechanism which may decrease its operating life.

If you are using the SWTPC PR-40 printer with the SWTPC 6800 computer system, you may use the OUTCHR subroutine listed from address A014 through A024 in the PRNTST diagnostic within your own program for outputting characters to the printer. The index register must be loaded with the starting address of the MP L parallel interface board feeding the printer. The character to be printed must be loaded into accumulator A and the contents of accumulator B are destroyed during the subroutine.

Never install or remove the interface board when the system is powered up. Doing so is not only hazardous to the equipment, but bypasses the normal power up sequence required by the internal registers within the 6820 integrated circuit in order to guarantee proper operation. ■

Note: MIKBUG is a trademark of Motorola Inc.

Listing 1: A debug and test program written for a 6800 type system with MIKBUG. The hexadecimal address of the selected port is loaded into memory locations A002 and A003 which are referred to by PARADR. The program counter is initiated at the beginning of the program. The program sends out a carriage return, hexadecimal ASCII characters 21 through 3F followed by a carriage return, followed by hexadecimal ASCII characters 40 through 5E, and repeated indefinitely.

Address	Op	Operand	Label	Mnemonic	Commentary
A014	A7	00	OUTCHR	STA A 0,X	PARADR:=A;
A016	C6	37		LDA B #37	} PARADR+1:=37;
A018	E7	01		STA B 1,X	} [data ready port]
A01A	C6	3F		LDA B #3F	} PARADR+1:=3F;
A01C	E7	01		STA B 1,X	} [data ready port]
A01E	6D	01	LOOP3	TST 1,X	check if data accepted signal received;
A020	2A	FC		BPL LOOP3	if signal not present go to LOOP3;
A022	E6	00		LDA B 0,X	else B:= PARADR
A024	39			RTS	return;
A048	A0			MSB	} [program counter]
A049	4A			LSB	}
A04A	FE	A 0 02	START	LDX PARADR	X:= PARADR; [IO port address]
A04D	C6	FF		LDA B #FF	} PARADR:=FF;
A04F	E7	00		STA B 0,X	}
A051	C6	3F		LDA B #3F	} PARADR+1:=3F;
A053	E7	01		STA B 1,X	}
A055	86	0D	FSTLIN	LDA A #0D	} output carriage return;
A057	8D	BB		BSR OUTCHR	}
A059	86	20		LDA A #20	A:=20;
A05B	4C		LOOP1	INC A	A:=A+1;
A05C	81	40		CMP A #40	compare A to 40;
A05E	27	04		BEQ NXTLIN	if A=40 go to NXTLIN;
A060	8D	B2		BSR OUTCHR	go to OUTCHR;
A062	20	F7		BRA LOOP1	go to LOOP1;
A064	86	0D	NXTLIN	LDA A #0D	} output carriage return;
A066	8D	AC		BSR OUTCHR	}
A068	86	3F		LDA A #3F	A:=3F;
A06A	4C		LOOP2	INC A	A:=A+1;
A06B	81	60		CMP A #60	compare A to 60;
A06D	27	E6		BEQ FSTLIN	if A=60 go to FSTLIN;
A06F	8D	A3		BSR OUTCHR	go to OUTCHR;
A071	20	F7		BRA LOOP2	go to LOOP2;

Table 1: Hexadecimal starting addresses of the parallel IO port interfaces used by MIKBUG.

Port	Address in Hexadecimal
IO 0	8000
IO 1	8004 (reserved for control interface)
IO 2	8008
IO 3	800C
IO 4	8010
IO 5	8014
IO 6	8018
IO 7	801C

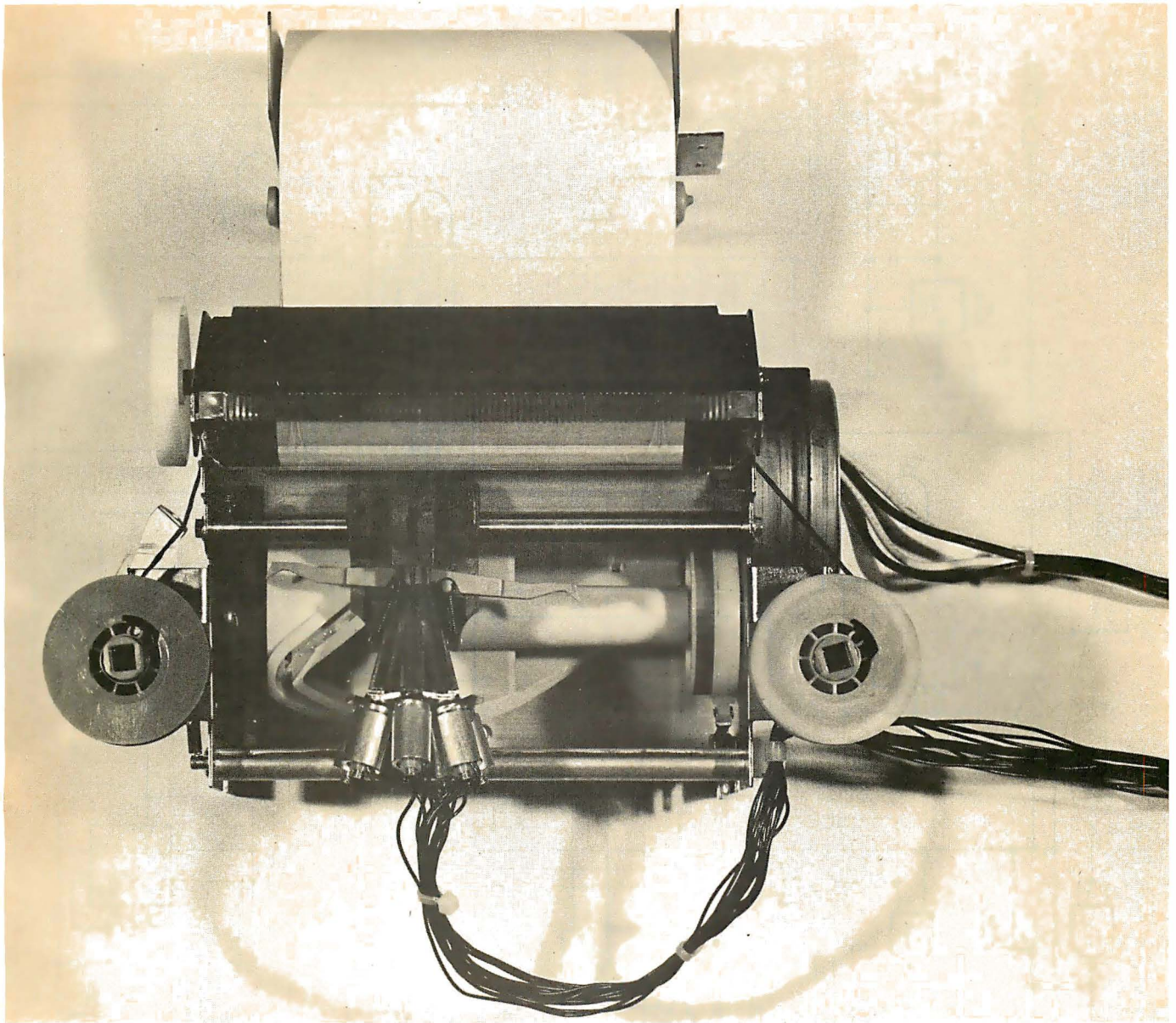

Photo 2: This photograph displays the mechanical parts of the PR-40 printer. The seven solenoids can be seen to converge in a line at the print head. The positioning mechanism for the printing head is seen as the spiral groove under the head mechanism.

this type of print head, this printer rotates a long cylinder just beneath the print head. The length of the cylinder itself is a little longer than the head's printing width on the paper. The cylinder has a uniform cyclic zigzag track formed on its outer circumference, running from the left side of the cylinder to the right side and then back to the left again. A small projection on the bottom of the print head rides in this track so that as the cylinder rotates, the print head moves back and forth from left to right. This technique moves the print head across the paper at a constant velocity except for the extreme ends, where nothing is being printed. This approach greatly simplifies the electronics needed to drive the printer since no head positioning circuitry is necessary. The cylinder itself is turned by an AC motor

on the lower right hand side of the print mechanism. (See photo 1.) A small ribbed nylon belt interconnecting the two sides on gear teeth of both the motor and cylinder. Also attached to the right side of the cylinder is a cam that actuates a roller arm microswitch riding on the cam. This is how the printer's electronic circuitry senses the start of line position of the print head. On the left side of the cylinder is an eccentric driven pawl arm that advances the paper one line for each revolution of the cylinder which is the same as one cycle of the print head.

Let's go through a single cycle of operation of a printed line where we will first assume the head is in rest position just left of center. When a line print command is initiated by the control circuitry, the motor

starts and the head begins to move from the center position toward the far left side of the printer where the head reverses direction. This nonprint dead zone gives the motor, cylinder and print head time to attain full speed. As the head begins its movement from left to right, the cam actuated microswitch opens telling the electronic circuitry to start sending solenoid driving pulses for the character. Somewhere before the print head reaches the far right hand edge of the paper, the solenoid pulses will cease while the head continues to move. When the head reaches the right end of its travel, it will mechanically reverse direction and begin to move back toward the center of the printer. During this return movement, the pawl arm will rotate the platen one line for the line feed. The motor is then turned off just to the left of center where it started originally. With our controller for this mechanism, character data is not accepted by the printer's circuitry during an actual print cycle; however, feeding continual print data from a computer to the printer may take place so fast that the print motor may never appear to stop between repeatedly printed lines although it actually does.

The operation of the printing ribbon used on the unit is also amazingly simple. A ratchet technique not only advances the ribbon incrementally for each cycle of the print head but automatically reverses it when it reaches the end of one of the two spools.

The Electronics

The electronic circuitry designed to drive the print mechanism can vary from nothing but motor and solenoid drivers constantly serviced by the microprocessor to a fully self-contained hardware control unit with

Table 2: Power pins for the circuit of figure 3.

Number	Device	+5 V	GND	-5 V	-12 V
IC1	3351	26		28	27
IC2	5241	12			23,23
IC3	7407	14	7		
IC4	7490	5	10		
IC5	555	8	1		
IC6	74121	14	7		
IC7	7407	14	7		
IC8	7474	14	7		
IC9	7420	14	7		
IC10	555	14	8		
IC11	7400	14	7		
IC12	7404	14	7		
IC13	7430	14	7		
IC14	7400	14	7		
IC15	7402	14	7		
IC16	7400	14	7		
IC17	7805		3		
IC18	7474	14	7		

memory needing only 7 bit parallel ASCII data and a data ready strobe control line from the computer. The printer electronics of the PR-40 fits into the latter category. The PR-40's controller has its own 40 character first in first out memory allowing the computer to send character data at whatever speed it wishes. The entire line is printed upon receipt of a carriage return, hexadecimal OD, or automatically whenever the 40 character line buffer has been filled. All control characters with the exception of a carriage return are ignored by the printer. They are not stored in the buffer line memory since they cannot be printed anyway. Repeated line feeds are initiated by sending repeated carriage return control commands. Since the controller generates upper case ASCII characters only, all lower

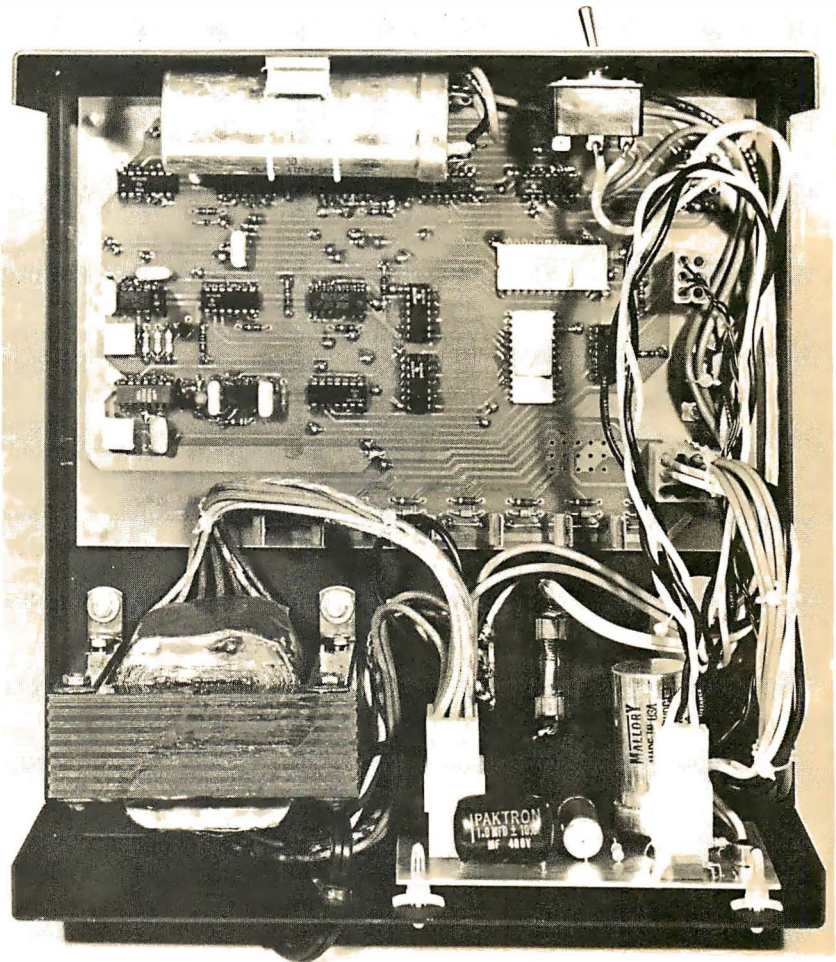

Photo 3: A view from the bottom of the PR-40 impact printer displaying the electronic circuitry of the system. The circuit board at the top left of the picture is the circuit for the power supply as described in figure 2. The circuit at the bottom of the picture is the electronic assembly for the print head driver. The large chip at the bottom left of the picture is the first in first out memory chip. The IC chip directly above it is the read only memory character generator.

case characters sent to the controller are transposed to their upper case equivalent before printing. The printer's line buffer memory is automatically cleared by a hardware power up reset circuit when printer power is first applied. The printer's triac controlled motor is powered by a 120 VAC secondary on the power supply's power transformer, as shown in figure 2. This not only provides power line isolation but allows the entire unit to be run on either 120 VAC or European 240 VAC power systems since the power transformer has two primary windings which may be either parallel or series connected.

The seven ASCII parallel data input lines, data ready, and data accepted control lines are all TTL compatible. The inputs represent a maximum of two standard TTL loads while the data accepted output will drive ten standard TTL loads. Data is presented to the printer by storing the selected ASCII data on the seven data input lines and strobing the normally high, logic 1, data ready input line low. This line should go low, logic 0, for at least 1 μ s and when it does the normally high data accepted will also go low. The character is not actually loaded until the data ready input is returned to its normally high state. The data accepted line will then normally return high as well, indicating that the character has been loaded. However, when loading the 40th character on a print line or a carriage return command, this data accepted line will not return high until all the previously stored data has been printed and the printer memory is ready for more data. The PR-40's printer controller will ignore all data sent to it while the data accepted line is low. So you will usually want to make sure the data accepted output line is high before sending the controller more data to be printed.

If you are careful not to output data faster than one character per μ s and allow a minimum one second delay before sending data after sending a carriage return or the 40th character of each line then you may avoid using the data accepted line altogether. However, using the data accepted line will give your system the fastest possible print speed.

How It Works

All ASCII character data is presented to the first in first out memory, IC1, through hex inverter and buffer, IC12. NAND gate IC14A makes any necessary conversions from lower to upper case characters. 8 input NAND gate IC13 monitors the incoming ASCII data in search of a carriage return, hexadecimal 0D, control command. If it

decodes a carriage return it will prepare normally high control flip flop IC8A to go low on the falling edge of the data ready control signal. NOR gate IC15A decodes all control characters and along with IC15B inhibits any control characters from being loaded into the buffer memory. NAND gate IC9A is responsible for generating the data accepted control output whenever data has been accepted by the buffer memory or acknowledged by the control character decode logic. It also inhibits the data accepted output while the printer is in the process of printing a line.

Control flip flop IC8A's Q output is high when the printer is in the idle state. A buffer memory full signal decoded by NOR gate IC15D or a decoded carriage return command by IC13 resets this flip flop low which turns the printer's motor on through transistors Q1 and Q2 located on the power supply board which starts a line print sequence.

When the print head advances to the start of line position, the roller arm microswitch changes states which flips RS latch NAND gate IC11D low which allows free running oscillator, IC10, to feed divide by 2 flip flop, IC8B. This divide by 2 feeds both the dot counter, IC4, and solenoid timer, IC6. This solenoid timer is used to set the on time of the printer's solenoids. If set too long, the solenoids will overheat; if set too short, the printed lines will be too light. An on time duration of 400 μ s is the best compromise setting. Decode counter IC4 has its B and C outputs tied back to its zero reset inputs forcing it to become a modulo 6 counter. As the counter progresses from 0 to 4 inclusive, the selected character lines are decoded by the read only memory, IC2, using the ASCII data fed to it by the buffer memory, IC1, and fed onto the solenoids through buffers IC3 and IC7 and Darlington drivers Q1 and Q7. Counter state 5 is decoded by the read only memory as a blank for the one dot space necessary to separate the printed characters. In the latter phase of the five count the memory buffer is shifted, the counter resets, and the sequence repeats. When the memory buffer finally empties, the read only memory is disabled and blanks the output for the rest of the print cycle. When the still moving print head reaches its normal rest position, the roller arm microswitch again changes states. This time RS latch NAND gate IC11C flips low, setting control flip flop, IC8A, back to normally high state. Timer IC5 is a power up clear circuit which empties the first in first out buffer memory and helps prevent random firing of the print solenoids during power up. ■

The PR-40 alphanumeric printer is manufactured by Southwest Technical Products Corp, 219 W Rhapsody, San Antonio TX 78216. It is sold in kit form only. The kit number is #PR-40 for \$250 post paid in the United States. The kit includes the print mechanism, chassis, circuit boards, components, power supply, assembly instructions, one ribbon and one roll of paper.

The POLY 88 Microcomputer System

If you are into computers or considering a system, the POLY 88 is the machine to contemplate.

HARDWARE

- Popular 8080 central processor • Single-board CPU with ROM, RAM, vectored interrupt, real time clock, single-step logic and serial I/O • Video interface card - generates video to TV monitor and provides parallel keyboard input port • Serial and cassette mini-cards plug directly into CPU with ribbon cables • Cassette
- ROM monitor with powerful debugger, video software, bootstrap loader • Backplane and power supply on one board simplifies construction • Rugged 6 amp power supply • All circuit boards are high quality, double-sided with plated-through holes • System is compatible with a wide range of Altair peripherals • Minimum point to point wiring means that the POLY 88 kit can go together in three evenings!

ABOUT SOFTWARE

Software is the reason the POLY 88 was designed. The operator can proceed from higher level languages like BASIC to developing machine code with the aid of our assembler. Our BASIC is a full 8K BASIC with character and byte manipulation. Best of all, the programmer is finally free of the teletype emulation mode so the video display can be used to full advantage.

The video display provides a unique opportunity to write new types of programs and games. Characters (16 lines of 64) and graphics (48 by 128 grid) are part of the processor's memory, so the display may be altered rapidly — the entire screen written in less than 20 milliseconds.

POLY 88 hardware provides many additional features that programmers have come to expect, such as vectored interrupt and real time clock.

See it at your local computer store.

ARE YOU NEW TO COMPUTERS?

The POLY 88 was designed for ease of use. No one should have to learn all the inner workings of computers just to enjoy one at a reasonable price. With the POLY 88, you can "play" pre-developed programs or explore the world of computer languages as your interests expand.

THE POLY 88 IS FOR EVERYONE

Want to develop a new computer language? Want to fight Klingons? The POLY 88 provides a firm foundation upon which to build your interests and develop your skills.

POLY 88 SYSTEM PRICES:

SYSTEM 1 — Kit includes 8080 vectored interrupt processor with real time clock, ½ K of RAM and 1K monitor on ROM: Video Terminal Interface displays 16 lines of 32 characters on a video screen and has a keyboard input port; cabinet, backplane, and power supply; complete assembly, operation and theory manual. \$595.

SYSTEM 2 — System 1 plus 64 character line option and Byte/biphase cassette interface kit. \$690.

SYSTEM 3 — System 2 plus 8K of RAM with BASIC and assembler programs on cassette tape. \$990.

SYSTEM 4 — The complete kit. It includes system 3 and TV monitor, keyboard and cassette recorder with all necessary cables and connectors. \$1350.

SYSTEM 7 — System 4 assembled, tested and ready to run. \$1750.

ACCESSORIES — 8K RAM kit, \$300. Assembled \$385
POLY I/O Ideaboard, hardware prototyping kit board. \$55.
Analog Interface (1 channel) kit. \$145.

Prices effective until January 15, 1976. Prepaid orders shipped postpaid.

**PolyMorphic
Systems**

737 S. Kellogg, Goleta, CA 93017
(805) 967-2351

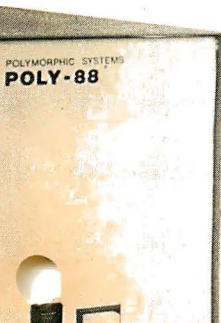

Cassette Transports for the "Roll Your Own" Hobbyist

Use of the Phillips Compact Cassette as a storage medium has been well established. Articles in *BYTE* and other publications have made the audio cassette just about the only storage device for the computer hobbyist. However, not enough attention has been given to the machine in which the cassette is operated. From various articles the usual transport mechanism is usually referred to as a cheapie or \$30 cassette recorder. The usual control is a relay used to turn on the entire device. I regard this method as less than satisfactory and suggest that there are better ways.

When the low cost cassette machine is

turned on or off with a relay, two difficulties are immediately apparent. First the pinch roller is always engaged, which can cause a dent in the roller if left too long in this position. The dent will cause serious wows in the tape speed. Second, the startup time will be excessively long. This leads to the conclusion that the entire tape transport mechanism should be controlled by the computer. All of the transport functions, play, stop, rewind and fast forward, should be available on command by the computer.

Audio cassette transports which will meet the requirement of being controlled by logic signals are available and can be purchased by the computer hobbyist. These transports have usually been available to the original equipment manufacturer (OEM), but the various manufacturers have indicated that they will sell to individuals or groups. One of the manufacturers of cassette transports, the Economy Company, has been actively promoting use of their deck for data storage, but more about it later.

To the best of my knowledge, there are only four companies in the US making and selling "bare bones" cassette transports. One of these companies, TELEX Communications, only has a manually operated transport, which cannot be controlled by a computer and is of no real interest to the computer hobbyist, even though it is a well constructed, rugged unit. The three remaining companies, Amilon Corporation, the Economy Company and the Mincom Division (Wollensak) of 3M, all have transports which are amenable to logic control since they have solenoids doing the work.

The Amilon Corp has two cassette transport models which might be used by the computer hobbyist. One model, the A9, is primarily an audio unit with mono or stereo heads for playing or recording usual audio type information. The other model, the A7, has characteristics slanted to the data storage business. The two machines are very much alike structurally, being built on the same basic frame. They are the same in size and weight, and require the same electrical inputs. Table 1 lists the performance details and shows the similarity of the two transports.

Optical end of tape sensing is available as

William H Freeman
816 Meadowlark Ln
Glenview IL 60025

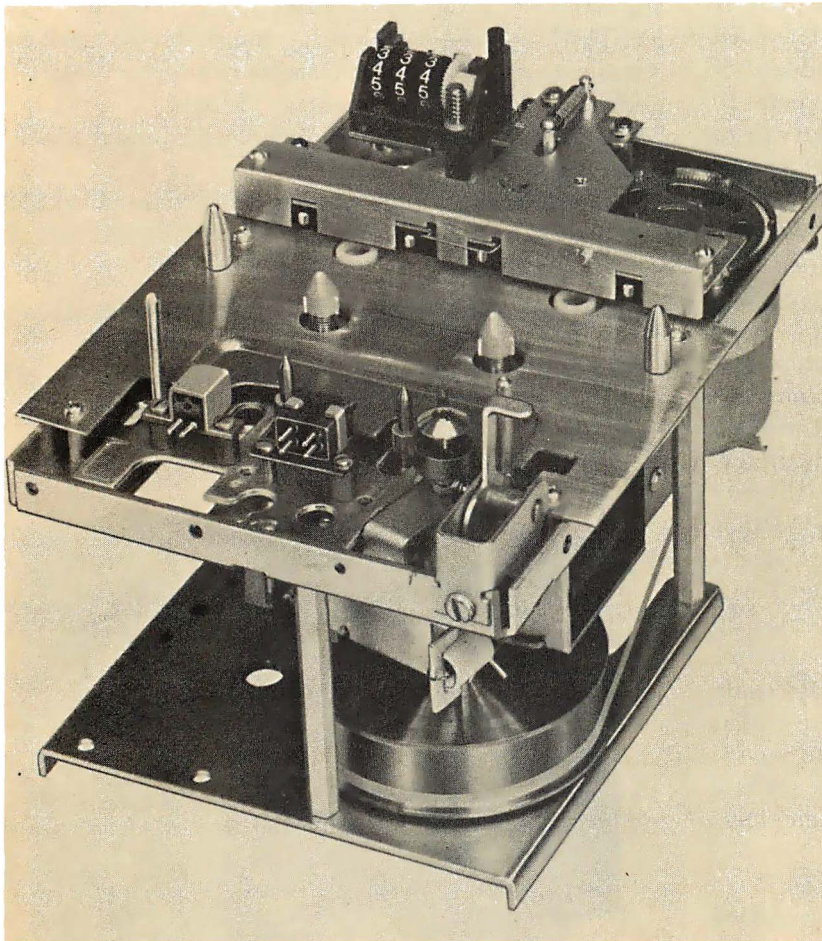
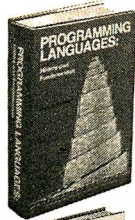

Photo 1: The Amilon A9 cassette transport. It is similar to the A7 transport varying only in a different head mount and the lack of an index counter on the A7 model.



767/513
PROGRAMMING LANGUAGES: History and Fundamentals
 by J. E. Sammett
 Pub. price, \$21.00
 Club price, \$17.50



767/53X
PROGRAM STYLE, DESIGN, EFFICIENCY, DEBUGGING AND TESTING
 by D. V. Tassel
 Pub. price, \$12.00
 Club price, \$9.95



767/130
WHY INFORMATION SYSTEMS FAIL
 by H. C. Lucas, Jr.
 Pub. price, \$11.00
 Club price, \$8.95



767/98X
THE PROGRAMMERS INTRODUCTION TO SNOBOL
 by D. Maurer
 Pub. price, \$13.50
 Club price, \$11.40

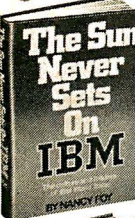

767/084
THE SUN NEVER SETS ON IBM
 by N. Foy
 Pub. price, \$7.95
 Club price, \$6.75



767/211
PEOPLE-ORIENTED COMPUTER SYSTEMS
 by E. A. Tomeski and H. Lazarus
 Pub. price, \$13.95
 Club price, \$10.75

Introductory offer to new members of the COMPUTER PROFESSIONALS' BOOK CLUB

any one of these great professional books for only **\$1.89** values up to \$30.00

Special \$1.89 bonus book comes to you with your first club selection

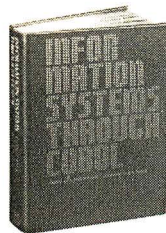

497/672
INFORMATION SYSTEMS THROUGH COBOL
 by A. S. Philippakis and L. I. Kazmier
 Pub. price, \$15.95
 Club price, \$12.50

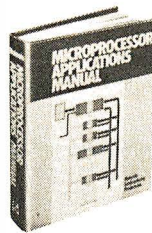

435/278
MICRO-PROCESSOR APPLICATIONS MANUAL
 by Motorola Semiconductor Products, Inc.
 Pub. price, \$28.50
 Club price, \$22.50

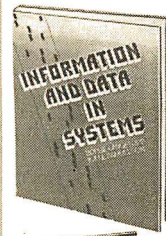

768/854
INFORMATION & DATA IN SYSTEMS
 by B. Langefors & K. Samuelson
 Pub. price, \$14.95
 Club price, \$12.25

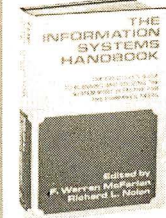

769/29X
THE INFORMATION SYSTEMS HANDBOOK
 by F. W. McFarlan and R. L. Nolan
 Pub. price, \$30.00
 Club price, \$22.50

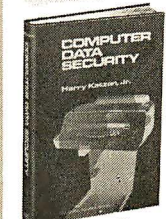

767/068
COMPUTER DATA SECURITY
 by H. Katzan, Jr.
 Pub. price, \$12.95
 Club price, \$9.75

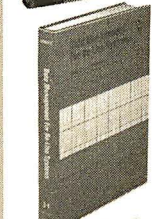

767/343
DATA MANAGEMENT FOR ON-LINE SYSTEMS
 by D. Lefkovitz
 Pub. price, \$14.95
 Club price, \$11.95

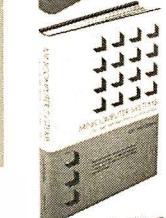

766/770
MINICOMPUTER SYSTEMS Structure, Implementation, and Applications
 by C. Weitzman
 Pub. price, \$19.50
 Club price, \$14.50

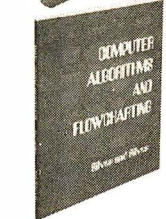

574/456
COMPUTER ALGORITHMS AND FLOW-CHARTING
 by G. A. Silver and J. B. Silver
 Pub. price, \$8.55
 Club price, \$7.25

save time and money by joining McGraw-Hill's new COMPUTER PROFESSIONALS' BOOK CLUB



This new professional club is designed to meet your day-to-day on-the-job needs by providing practical books in your field on a regular basis at below publisher prices. If you're missing out on important technical literature—if today's high cost of reading curbs the growth of your library—here's the solution to your problem.

The Computer Professionals' Book Club was organized for you, to provide an economical reading program that cannot fail to be of value. Administered by the McGraw-Hill Book Company, all books are chosen by qualified editors and consultants. Their understanding of the standards and values of the literature in your field guarantees the appropriateness of the selections.

How the Club operates: Every month you receive free of charge The Computer Professionals' Book Club Bulletin. This announces and describes the Club's featured book of the month as well as alternate selections available at special members' prices. If you want to examine the Club's feature of the month, you do nothing. If you prefer one of the alternate selections—or if you want no book at all—you notify the Club by returning the card enclosed with each Bulletin.

As a Club Member, you agree only to the purchase of four books (including your first selection) over a two-year period. Considering the many books published annually, there will surely be at least four you would want to own anyway. By joining the club, you save both money and the trouble of searching for the best books.

MAIL THIS COUPON TODAY

COMPUTER PROFESSIONALS/Book Club
 P.O. Box 582 Princeton Road, Hightstown, New Jersey 08520

Please enroll me as a member and send me the two books indicated. I am to receive the bonus book at the introductory price of \$1.89 plus my first selection, plus tax, postage and handling. If not completely satisfied, I may return the books within 10 days and request that my membership be cancelled. If I keep the books, I agree to take a minimum of three additional books during the next two years at special Club prices (guaranteed 15% discount, often more). I will receive the Club Bulletin 12 times a year. If I want to examine the featured selection, I need take no action. It will be shipped automatically. If, however, I want an alternate selection—or no book at all—I simply notify the Club by returning the convenient card always enclosed. I will always have a minimum of ten days in which to return the card and you will credit my account fully, including postage, if this is not the case. Membership in the Club is continuous but cancellable by me at any time after the four-book purchase requirement has been filled. This order subject to acceptance by McGraw-Hill. Orders from outside the continental U.S. must be prepaid. All prices subject to change without notice. Offer good for new members only.

Write Code # of \$1.89 bonus book selection here

Write Code # of first selection here

NAME _____

ADDRESS _____

CITY _____

STATE _____ ZIP _____

EXTRA SAVINGS: Remit in full with your order, plus any local and state tax, and McGraw-Hill will pay all postage and handling charges.

P39185

an option. The lamp used is a 5 V, 100,000 hour rated lamp. Four kinds of cassette sensing options are available using up to four micro switches to sense the cassette in place, record tab A and tab B and side A. Side A sensing is detecting the off center slot on the back edge of the cassette which is present in a computer cassette.

Both the capstan and reel motors are AC induction motors which means long, reliable operation with no brush noise problems. The capstan motor is a synchronous one and is used to drive only the capstan, insuring accurate speed. The other motor is used to drive either the takeup spindle in the play, record, and fast forward modes or to drive the supply spindle in the rewind mode. Amilon claims this is the reason for the excellent wow and flutter performance as there is no motor acting as a drag when in the play or record mode. The mechanical structure is solid and stiff, assuring continued alignment of all parts. In particular, the pinch roller is mechanically isolated from the heads and is mounted on self-aligning instrument ball bearings to give even pressure on the capstan and minimizing any skew of the roller.

I was greatly impressed with the quality and attention to detail in this machine when the A9 model was demonstrated. Amilon Corp is also involved with digital cassette transports and some of their thinking has rubbed off on the audio cassette transport's design, to the audio transport's advantage. Photo 1 shows the Model A9 transport. The A7 model is almost identical, differing only in the head mount and its lack of an index counter.

You want to know what it costs? OK! Prices for the A7 transport, the data unit, start at \$210 for one (\$113.51 each in quantities of 100) which includes a precision head mount and a two track read and write head. End of tape sensing and cassette sensing switches are extra. Prices for the A9 transport start at \$164.75 for one (\$87.79 each in quantities of 100) which includes standard head mounts, stereo erase, and record and play heads. End of tape and cassette sensing switches are extra.

Next on the list of transports, alphabetically, is the Economy Company with its Phi-Deck. The Economy Co is a school book publisher for elementary education. Some years ago they added educational cassette

	A7	A9
Play or Record Speed	1.875 to 10.0 in per sec [†] 4.763 to 25.4 cm per sec	1.875 or 3.75 in per sec* 4.763 or 9.53 cm per sec
Speed Accuracy	±2% at any speed	±1% (±0.3% available) at any speed
Wow and Flutter	not stated	<0.1% NAB weighted
Reel Controlled Search Speed	50 in per sec average 127 cm per sec average	not available
Fast Wind or Rewind	not available	70 sec for C60 cassette
Start Time	<40 ms	<300 ms
with speedup circuit	<25 ms	
Stop Time	<60 ms	<50 ms
Sensor Switches	SPDT	SPDT
Operating Humidity	0 to 95% noncondensing	
Operating Temperature	+5° to +50°C	
Storage Temperature	-20° to +70°C	
Size	5.16 by 7.00 by 4.61 in 13.10 by 17.78 by 11.71 cm	
Weight	5.00 pounds 2.27 kilograms	
Capstan motor (synchronous)	117 V ± 10%, 50 or 60 Hz, 11 W	
Reel motor (fast mode)	24 V ± 10%, 50 or 60 Hz, 13 W	
(play mode)	18 V ± 10%, 50 or 60 Hz, 8 W	
Solenoids	24 VDC, ±5%, 600 mA	
[†] Ten different speeds available:	1.875, 2.0, 3.0, 4.0, 5.0, 6.0, 7.0, 8.0, 9.0, 10.0 in per sec 4.763, 5.1, 7.6, 10.2, 12.7, 15.2, 17.8, 20.3, 22.86, 25.4 cm per sec	

*Dual speed pulley available.

Table 1: Comparison of the A7 and A9 cassette transports manufactured by Amilon comparing speed, accuracy, and power requirements of the two units.

SCELBI SOFTWARE

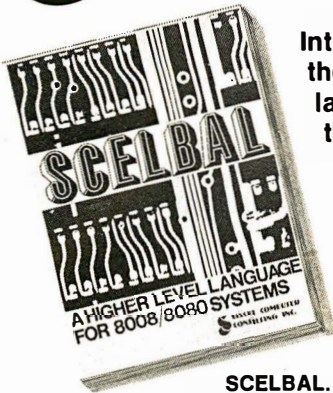

Introducing SCALBAL, the new microcomputer language that's simpler than machine language.

A complete language for "8008"/"8080" systems including source listings, routines, flow charts and more!

SCALBAL. SCientific ELEmentary BASic Language for "8008"/"8080" systems. A complete, illustrated program book. Routines. Techniques. Source Listings. Flow Charts. And more. Took several years to develop. Now yours for many years to come. First time that intimate details of higher level language has been offered for such a low price. Only \$49! You get **5 Commands:** SCR, LIST, RUN, SAVE, LOAD. **14 Statements:** REM, LET, IF... THEN, GOTO, FOR with STEP, END, INPUT, PRINT, NEXT, GOSUB, RETURN and optional DIM. **7 Functions:** INT, SGN, ABS, SQR, RND, CHR, TAB. And, it runs in 8K and more. Here's all the data needed to customize a high level language for your system... at a fraction of the cost!

Order your copy today! Get **\$49** ppd. started advancing your system!



Here's SCALBI's First Book of Computer Games for the 8008/8080. Action-packed. And fun.

Try to beat the computer at its own game. Here's the first complete machine language computer manual for computer games to include source listings, flow charts, routines and more. **Space Capture** — You against the computer using "search and destroy" strategy to shoot down roaming alien spaceships in outer space. **Hexpaw** — a mini-chess game that lets the computer make mistakes... but only once. **Hangman** — an updated version of the great kid game. Computer selects words at random from long, expandable list. Try to beat it in 8 moves or less. Illustrated. Fun extras to put your computer to challenging, competitive, fun use.

Order yours today! **14⁹⁵** ppd.

SCALBI's new microcomputer Game Book of Outer Space... **GALAXY**

Captain your own crusading starship against the logic of your "8008" or "8080". You must destroy a random number of alien ships without running out of stardates, out of fuel, out of ammunition or out of the galaxy. Plan your mission. How much fuel is used for your warp factor? Don't run into roaming stars that can damage your ship. **Suddenly! Condition Red! Alien in sight!** How big is he? Fire a phasor or torpedo! He's damaged or destroyed. But, you've used valuable fuel. That's just the beginning. A new game every time. Complete program book in machine language for 4K memory, including source listings, flow charts, routines, etc. Great intergalactic adventure and fun.

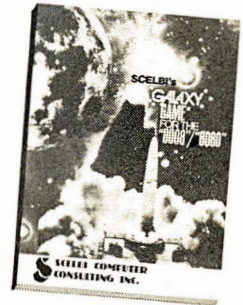

Order "GALAXY" today! **14⁹⁵** ppd.

"8080"

SOFTWARE MANUALS

Three new basic, complete "MUST" manuals! "8080" Assembler Program operates easily in 4K bytes of RAM (including symbol table). Unique feature: How to accept mnemonics related to "8080" based machines on "8080". Includes all major routines, pertinent flow charts, highly commented assembled listing and more. \$19.95
An "8080" Editor Program. Describes variations that can reside in 2K of memory. How to increase buffer size. How to manipulate "text" for "source listings" and other

text preparations. Discussion of routines, flow charts, assembled listings, more. Order now! \$17.95
"8080" Monitor Routines. Describes "Monitor Control" package to control operation from external "keyboard". Routines to examine and modify memory locations, CPU registers, set "breakpoints", "debugging" programs, control bulk storage I/O devices and more. Includes subroutine explanations, flow charts, assembled highly commented program listing. Order today! \$14.95

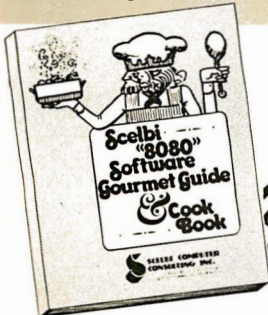
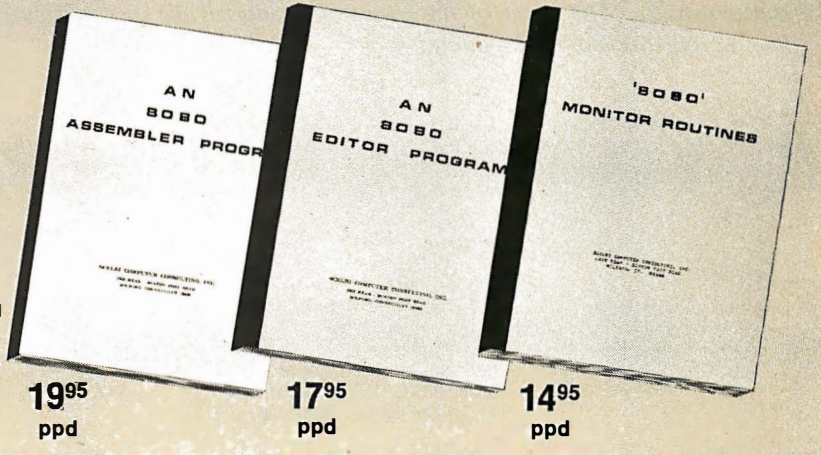

Now you can cook-up hot programs for your own "8080"

Gobble up practical "how to" facts, including the description of "8080" instruction set. How to manipulate the "8080" stack. Flow charts and source listings. General purpose routines for multiple precision operation. Programming time delays for real time applications. Random number generators. And many other basic programming function comestibles.

The "Cook Book" even includes a completely assembled floating point arithmetic program... plus input/output processing for your basic I/O programming through interrupt processing. Code and numeric conversion routines. Real time programming. Search and sort routines. And many, many more finger-lickin' goodies. Order your copy of Scelbi's "8080" Software Gourmet Guide & Cook Book today. Only \$9.95 ppd.

Bon appetite!

Prices shown for North American customers. Master Charge, Postal and Bank Money Orders preferred. Personal checks delay shipping up to 4 weeks. Pricing, specifications, availability subject to change without notice.

SCALBI COMPUTER CONSULTING INC.

1322 Rear Boston Post Rd., Milford, CT 06460
Telephone: 203/874-1573

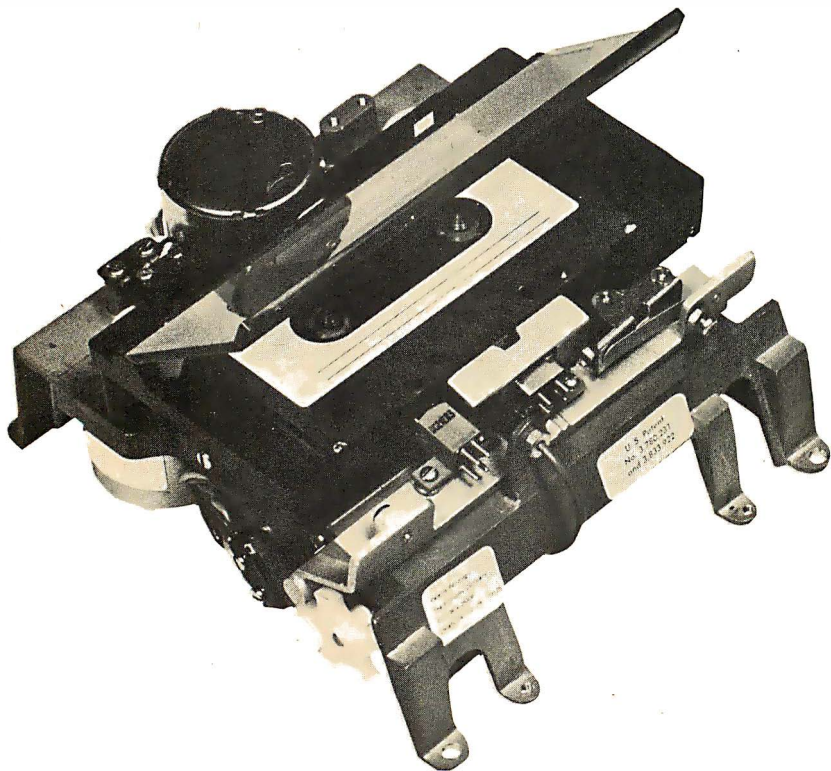

Photo 2: The Phi-Deck Super Deck model manufactured by the Economy Company. This model allows varying tape speeds by varying the voltage to the capstan motor. The frame of the cassette transport is die cast, reducing alignment problems and making it quite rigid.

publishing to their product line. This produced demand for an audio unit to play the cassettes, with Phi-Deck the result. Over a year ago I saw the Phi-Deck demonstrated. Since that time the number of Phi-Deck models has increased to three; the advanced model is shown in photo 2. In addition to the transports themselves, the Economy Co is offering control boards to do all the tricky functions on command. The three models are referred to as fixed speed, variable speed, and Super Deck; their performance is tabulated in table 2. At least one personal computing manufacturer (Digital Group) is now offering Phi-Deck as part of a system product at quite reasonable prices.

As is usually the case, the performance figures in table 2 do not tell the whole story. All three transports have four DC motors. One motor drives just the capstan, the speed being maintained by a voltage regulator supplying current to the capstan drive motor. Another motor is used to drive the supply spindle. Still another is used to drive the takeup spindle. And the fourth motor actuates the yoke on which are mounted the heads and the pinch roller by means of a Geneva movement. (A Geneva movement translates rotary motion into linear motion. One revolution of the motor pulls the heads and pinch roller into position and another revolution moves them out of position. The motor always turns in the same direction!)

These DC motors are ideal for direct control with transistors since they run off

Table 2: Comparison of the three cassette transports manufactured by the Economy Company giving electrical comparisons and the physical dimensions and weight of the transports.

	Fixed	Variable	Super
Speeds	1.88 in per sec standard 2.00, 3.75, 4.00, 5.00, 6.00 in per sec optional 4.77 cm per sec standard 5.08, 9.53, 10.16, 12.70, 15.24 cm per sec optional	0.40 to 20.00 in per sec 1.02 to 50.80 cm per sec	1.00 to 10.00 in per sec standard 0.40 to 3.00, 0.60 to 5.50, 0.85 to 8.50 in per sec optional 2.54 to 25.40 cm per sec standard 1.02 to 7.62, 1.52 to 13.97, 2.16 to 21.59 cm per sec optional
Wow and Flutter	<0.25% at 1.88 in per sec 4.77 cm per sec	<0.25% at 1.88 in per sec 4.77 cm per sec	not stated
Bit to Bit Jitter	not stated	±2%	±2%
Speed Accuracy	not stated	±3%	±3%
Start Time	<100 ms	<100 ms	<100 ms
Stop Time	<100 ms	<100 ms	<100 ms
Forward and Rewind Time	<30 sec for C60 cassette	<30 sec for C60 cassette	<30 sec for C60 cassette
Power Required	+12 VDC at 900 mA	+12 VDC at 900 mA	+18 VDC, -18 VDC, +11 VDC, +7 VDC, +5 VDC
Size	2.60 by 5.40 by 6.30 in 6.60 by 13.72 by 16.00 cm	2.60 by 5.40 by 6.30 in 6.60 by 13.72 by 16.00 cm	3.00 by 5.50 by 6.20 in 7.62 by 13.97 by 15.75 cm
Weight	2.20 pounds 1.00 kilograms	2.20 pounds 1.00 kilograms	2.80 pounds 1.27 kilograms

12 V. A transistor in series with the motor acts as a switch controlled directly from the logic circuits. Very straightforward and simple. The logic and control circuits, which can be purchased or built, can do a lot of elegant performing on the part of the transport. In connection with end of tape and beginning of tape sensing options, one can cause the cassette to play to the end, then rewind to the beginning, stop or start playing all over again. By controlling the regulator supplying the capstan motor, different speeds of playing can be obtained. Cassette in place and record tab sensing are also options that are available. With the variable speed model, a different pulley is used for each speed range. The Super Deck model covers its entire speed range with only one pulley.

Of the three models, the one I recommend is the Super Deck as shown in photo 2. It has a diecast frame, making it quite rigid, reducing alignment maintenance problems. The other two models, the fixed speed and the variable speed, have a sheet metal frame that is somewhat flimsy and leaves something to be desired in ruggedness. Literature supplied by the Economy Co suggests that the Super Deck model was designed with data applications in mind, and as such, would be more attractive to the computer hobbyist.

The price of the fixed speed Phi-Deck, including a stereo head, is listed at \$94.50 for one. The variable speed model, with all options, lists for \$99.50, with either a two halftrack digital head or a regular audio stereo head. The Super Deck, with all control and sensing options, lists for \$169 for just one at the time this was written. Electronic control board, remote control boxes and power supplies are also available.

Because of my past experience with maintenance problems, I have a prejudice against the use of DC motors. However, from data supplied by the Economy Co, it appears that they have made a very strong effort to improve the performance of their DC motors. Their data indicates that a mean time before failure of 5000 hours is a reasonable value. This would mean 2.5 years of operating time, assuming 40 hours a week for 50 weeks a year.

I have two objections to DC motors. First is the fact that the motors have brushes and commutators which wear, the brushes principally, and need to be replaced at intervals. In the case of the small motors being considered, many have no provision for replacing the brushes, so one must replace the whole motor. The second objection is that the brushes can cause noise in the associated circuitry, requiring additional

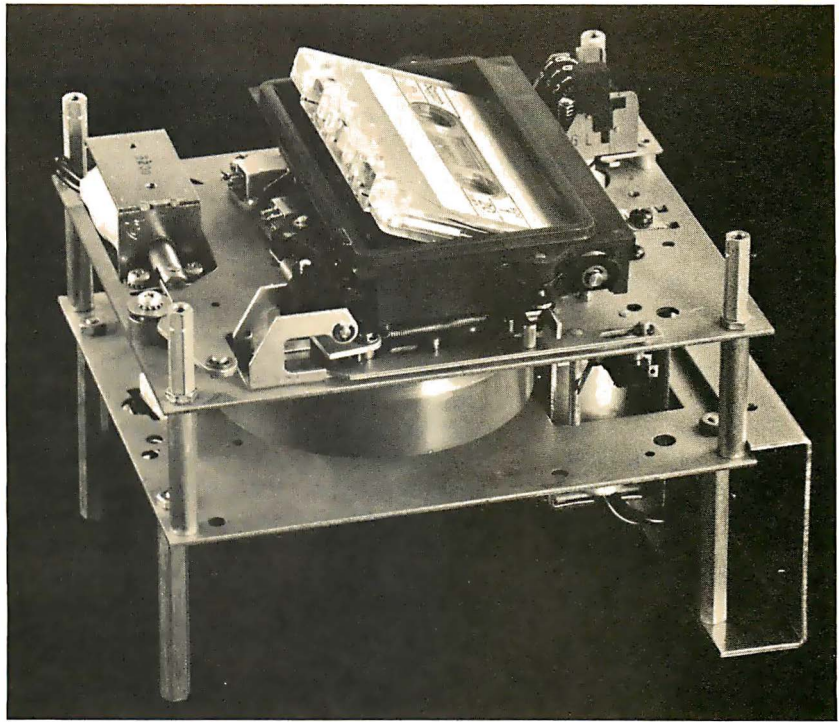

Photo 3: Wollensak Model 9576 and 9577 cassette transports. The two transports are identical, except the 9577 has an optical end of tape sensing unit. The basic construction consists of two heavy metal plates separated by standoffs to form the frame. A flat panel supplied by the user is put on the top of the transport to protect the inner mechanisms.

		Model 9576 and 9577
Play and Record Speed		1.875 in per sec 4.763 cm per sec
Speed Accuracy		±2%
Wow and Flutter		<0.25%
Rewind and Fast Forward Times		45 sec for C60 cassette
Solenoids		24 VDC 72 ohms
Light Source	(Model 9577)	subminiature lamp 5.0 VDC @ 0.075 A
Sensor	(Model 9577)	2N5778 Photodarlington
Size		5.63 by 6.75 by 4.78 in 14.29 by 17.15 by 12.14 cm
Motor Power		117 V, 50 or 60 Hz, 10 W

parts to suppress it. AC induction motors have no brushes, hence no noise or wear problems. With oilite sleeve bearings they run quietly for a long, long time.

The last transport models to be described are made by the Mincom Division of the 3M Company. There are three versions, very much alike: Model 9575, Model 9576 and Model 9577. Model 9575 is a manually controlled mechanism and is of no interest to us. Models 9576 and 9577 are solenoid controlled mechanisms which are what we want. All models have the same basic drive

Table 3: Performance characteristics of the cassette transports manufactured by Wollensak. The two models are the same except that the 9577 has an optical end of tape sensing unit that the 9576 does not have.

	Price	Performance	Mean Time Before Failure
AMILON	high	excellent	very good
PHI-DECK	medium	very good	very good
WOLLENSAK	medium	very good	excellent

Table 4: The author's comparison of the best tape transports manufactured by Amilon, Economy Company, and Wollensak. The ratings are in relation to how well the objectives of low price, high performance, and a long mean time before failure, are achieved.

arrangement. An AC induction motor, shaded pole, drives a large flywheel through a rubber tired idler. The flywheel is on the capstan shaft. The supply and takeup spindles are driven from the flywheel with rubber tired idlers. No belts are used in the drive mechanism. There is one belt but it is used to run the index counter. In the two models of interest, three solenoids control the operating functions. One solenoid is pulled up for play or record; another is pulled up for fast forward; and a third for rewind.

The Model 9576 and Model 9577 are identical in all respects except that the Model 9577 has an optical sensing circuit included. This optical sensing consists of a small 5 V lamp and a phototransistor. This will provide end of tape and beginning of tape sensing. Table 3 lists the performance of both models.

Photo 3 shows the basic construction of the Wollensak transport, consisting of two heavy plates separated by standoffs forming the frame. The user must supply some kind of flat panel with cutouts for the cassette tray, the eject lever and the index counter. Four screws will attach the unit to this panel. This transport, like its big brother units made by Wollensak, is well built and should have a long service life with a minimum of maintenance. My experience with the full size Wollensak cassette units is that they run, and run, and run.

The latest prices available to me are \$79.50 for Model 9576 and \$85.75 for Model 9577 in quantities of 1-9. In 100 lot quantities prices are \$65 and \$71.25, respectively. Heads for the transport are extra.

How should these three cassette transports be evaluated? We can use three criteria: price, performance and reliability. Price is easy, just look at the figures. Performance and reliability are not so easy to establish because each potential user will assign different values to the various details of performance depending on the end objective and his or her bias. My bias has already been stated. My evaluations are given in table 4.

Some explanation may be necessary. Amilon is rated excellent in performance because of its very low wow and flutter

figure and its tight speed control with a synchronous motor. Wollensak is rated excellent in the mean time before failure column because of my past experience with Wollensak cassette units covering more than six years of usage in the school environment.

If I had an overflowing purse, I would buy the Amilon unit because of its excellent performance. Price is, however, a very demanding factor, so the Wollensak is my choice as the best buy. The Phi-Deck comes in very close in this decision. It is a certainty that not all readers will agree with this evaluation, which is certainly your privilege. The individual who is putting out the green stuff is entitled to make his or her own choice based on what is felt to be important. As they say, "That's what makes a horse race."

Where can you get one of these cassette transports? In alphabetical order: for an Amilon deck write to Leonard Rosenblatt, Amilon Corp, 49-12 30th Av, Woodside NY 11377; for a Phi-Deck you can find the address in ads in BYTE, but here it is anyway — The Economy Co, Triple I Division, 1901 N Walnut, Oklahoma City OK 73105; and for the Wollensak deck, write to Scott Goff, Sales Manager, Wollensak OEM Products, Mincom Division, 3M Co, 3M Center, St Paul MN 55101.

As a kind of post script to this article, I have included a few words of wisdom about using cassette transports, or any tape machine. *Preventive maintenance* will keep your cassette transport running without problems. Regularly do the following:

1. Clean the capstan, pinch roller, heads and guides after every 10 hours of operation. Use a good fluorocarbon, low toxicity head cleaner; one that will not attack rubber or plastic parts.
2. Keep all parts as dust free as possible. Use a dust cover over the transport when not in use.
3. Lubricate as often as the manufacturer specifies. Do not overlubricate; be sparing with the oil.
4. Demagnetize the heads, capstan and guides with a good head demagnetizer after every 10 hours of operation.

Overall performance will be considerably affected by the quality of the cassette used. Use a good to high quality cassette. Cheap cassettes will have poor tape quality and, even worse, poor mechanical performance which will adversely affect the tape speed. You will find that with the better to best tapes, you get better recordings with better frequency response and all around better performance. ■

Meet the Challenger.™

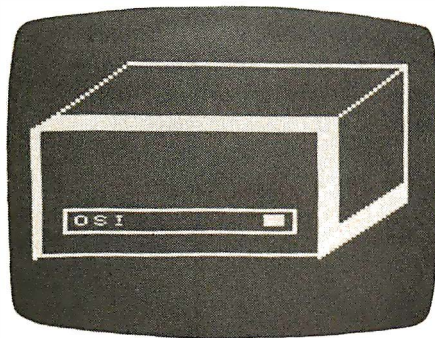

The Challenger
Self Portrait

The new price and performance champ from OSI.

He's got his act together!

Even our lowest-cost Challenger comes fully assembled, complete with a 500 ns 6502A, serial interface, 1,024 words of memory and a UL-approved power supply, all for \$439. Every Challenger comes ready for easy expansion with an 8-slot mother board, backplane expansion capability, and a power supply heavy enough to handle a full complement of system boards. Our 4K Challenger comes ready to run BASIC minutes after you unpack it. And there's more.

He packs some heavy hardware.

You've never seen memory and interface options like these—not at our prices, fully assembled! 4K RAM memory boards \$139! (see below). Single drive OSI Challenger Floppy Disk \$990! Dual drive Floppy \$1490! Plus 8K PROM boards! A Video Graphics board, including alphabetics, graphics, and **color!** An audio cassette, A/D, D/A and parallel I/O board! A backplane extender board! A prototyping board! And our extraordinary **CPU Expander Board**—it lets you run a Z-80, and 6100 (PDP-8 equivalent) **concurrently** with The Challenger's 6502, or under its control.

There's nothing soft about his software!

OSI has full software support for our Challengers. Including extended BASIC, extended Video Monitor, a Disk Operating System, some very Hollywood real time programs for Video Graphics, Animation, Sound Processing and so forth, plus PROM firmware, with more to come.

He's fast!

You can order The Challenger with a 6502C for a 250 ns cycle time, with a standard 6502A for 500 ns cycle time, or with a 6800 for 1 microsecond cycle time. And with

our CPU Expander Board, you can always update to any new CPU to be as fast as fast can be.

And he isn't just good!

He's better! By design. The OSI Challenger is the only completely-assembled, ultra-high-performance, fully-expandable mainframe computer that does this much for this little. Get your hands on one now. Send for your Challenger today.

You can't beat The Challenger!

The OSI Challenger 65-1K. Fully assembled. Features 6502A CPU, serial interface, 1,024 words of memory. **\$439.**

The OSI Challenger 65-4K. Same as 65-1K but with 4,096 words of memory. Will run Tiny BASIC without expansion. **\$529.**

The OSI Challenger 65V-4K. NO NEED for an expensive terminal. Connects to your ASCII keyboard and video monitor through included OSI 440 Video Board. Features software utility that simulates a deluxe CRT terminal. **\$675.**

The OSI Challenger 68-1K. Based on 6800 CPU. For the casual hobbyist, smaller systems. The Challenger 68 series comes only in serial interface forms and is compatible with MIKBug software through an included OSI software utilities package. **\$459.**

The OSI Challenger 68-4K. With OSI 4K BASIC on paper tape. **\$529**
SPECIAL! ADDITIONAL 4K MEMORY BOARDS. Ordered with your Challenger, limit 3 more at this special Low Price, (total 16K, including 4K already on-board in mainframe). **\$139**
Buy 12K or larger Challenger 65 system and we include Extended BASIC FREE!

OSI Challenger Floppy Disk System. Fully assembled, for use with OSI Computers only. **\$990** Single drive **\$1490** Dual drive.

OSI Audio Cassette Interface. Comes assembled, but with room for you to populate with A/D and D/A chips later. (OSI 430 based) **\$89**
And all the baseboards and kits of the powerful OSI 400 System.

OK, OSI, I'm ready to buy!

To order your Challenger System, send the total amount of your purchase plus \$4.00 for shipping and insurance (plus sales tax for Ohio orders) by personal money order or check. Or indicate **all** numbers on your BankAmericard or Master Charge to charge your order. Or send a 20% (non-refundable) deposit to receive your order C.O.D. Delivery is typically 60 days (except when payment is by check, which must clear before shipment can be made). Deliveries are scheduled on a first ordered, first shipped basis.

Name _____

Address _____

City _____ State _____ Zip _____

Telephone _____

Bank card info Inter Bank # _____

Expiration Date _____

Account # _____

Check M. O. BAC MC
20%, bal. C.O.D.

Order attached.

Send additional information on The OSI Challenger.

Send additional information on OSI 400 Kits.

\$1.00 enclosed for complete OSI Catalog.

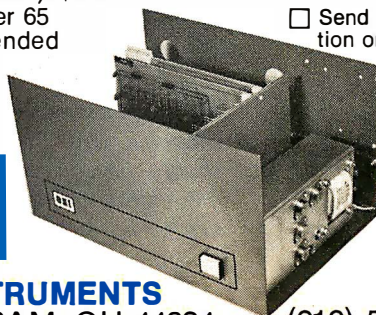

OSI

OHIO SCIENTIFIC INSTRUMENTS

Dept. B 11679 HAYDEN STREET, HIRAM, OH 44234

(216) 569-7945

at the servo and in the displays used to monitor the position count.

The program is quite simple: It generates a positive going pulse on the bit 0 line of the PIA output port, a pulse which lasts from 1 ms in length to $1 + 0.012n$ ms where n is

an 8 bit number which is incremented once each time around the outer loop of the program. The 0.012 ms factor is based on the processor's clock at the time of the test, 500 kHz, and the 6 state loop at addresses 201F and 2020 which times the width of the variable portion of the pulse. With the servo illustrated in photo 1, the wiring used was as

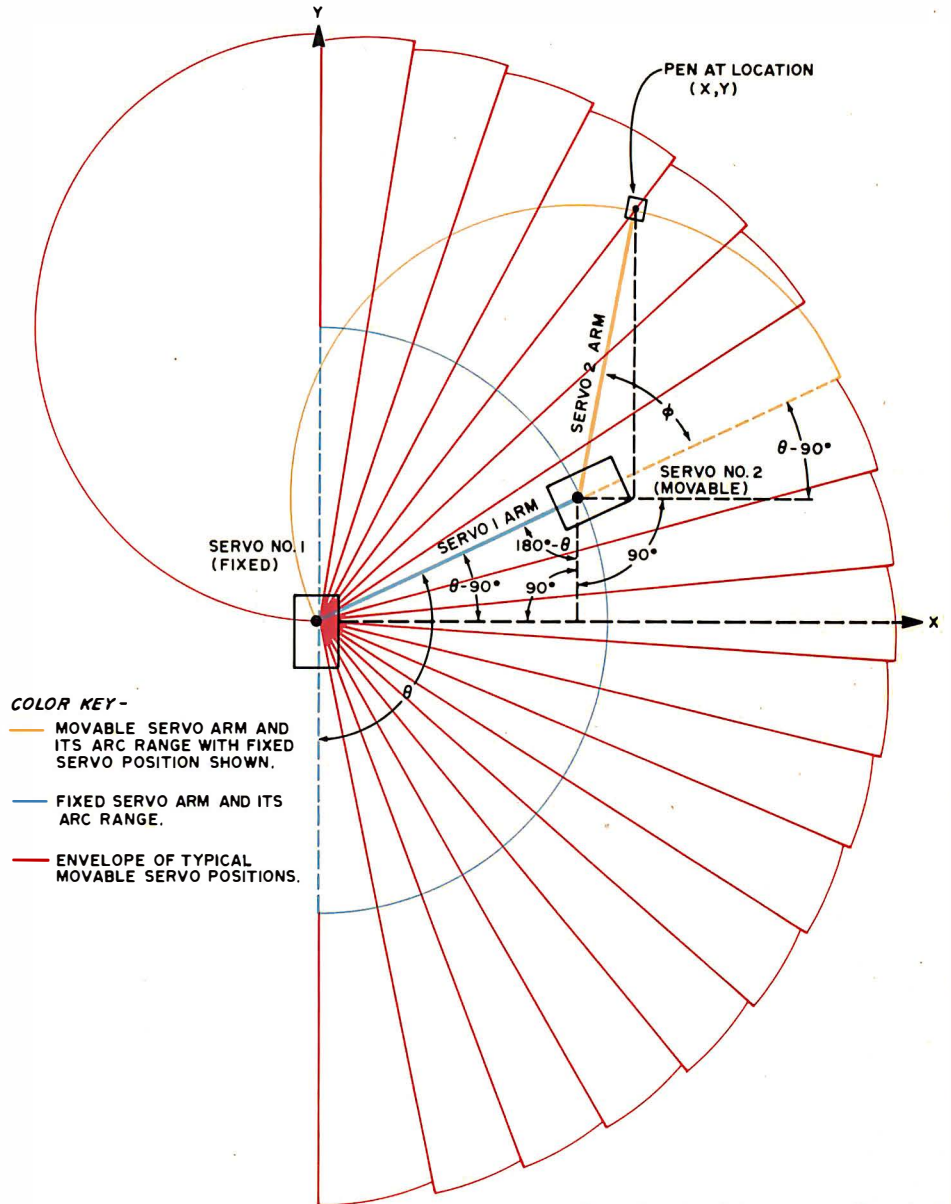

Figure 2: This diagram shows the concept of how to build a plotting bed based upon two model aircraft servomechanisms. The method of building consists of fixing one servo to the plotting bed, with a lever arm of length R . At the end of that lever arm, fix the second servo with a second lever arm of length R also. The end of the second arm should have a pen affixed to a solenoid mechanism or other actuator, allowing the pen to be raised or lowered. Due to weight considerations, the second servo should be

mounted so that it slides on a teflon skid or rolls on some form of loose ball roller. The mathematics of calculating X and Y given angles ϕ and θ is shown in the drawing. To invert the calculation requires use of a reiterating calculation to a set of ϕ and θ values which solves the desired X and Y position. To use this plotter requires a system which has sufficient memory to run a fixed point trigonometric package with at least 16 bits of precision, assuming a 13 bit precision for the angular parameters of the servos.

follows: +5 V was the red wire, ground was the black wire, and the TTL output of PIA bit zero was used to drive the blue wire.

The results of the test are somewhat interesting. When this program was run, the servo was observed to have a total travel of 180° rotationally. A unique relationship between the integer pulse width parameter stored in DATA in this program and the shaft position was observed, but the minimum acceptable pulse width for the device we purchased was probably 1.3 ms. The reason for this conclusion is that the servo illustrated two regimes of settings: For counts of 00 to 19 hexadecimal (0 to 25 decimal) it swept out clockwise motion from 180° to 0° (relative angles). The motion was partitioned into very noticeable and large steps over this range. Then, from counts 19 to D6 the servo swept counterclockwise from 180° to 0° with what looked like roughly linear steps. This range of 189 steps is about 0.95° per step. At the high end of the count range, D9, the servo hit its limit stop. Thus, based on this experiment, the actual numbers work out as follows:

Minimum pulse width:
 $1 + 0.012 \times 25 = 1.3 \text{ ms}$

Maximum pulse width:
 $1 + 0.012 \times 214 = 3.6 \text{ ms}$

In using this servo, or any similar mechanism for an experimental project, readers would want to investigate the linearity of the position output with respect to the control parameter, and use a higher resolution timing method. For example, to make the world's least expensive plotter, using a 13 bit counter with a 2 MHz crystal clock, decimal counts of from 2600 to 7200 would cover the range of timing values found above, giving a control parameter range of 0 to 4600, approximately 0.04° per step assuming linear characteristics. Using trigonometry, this corresponds to an arc motion of 0.00683 inches per step at the end of a 10 inch lever arm (0.17 mm per step at the end of a 25 cm lever arm). Using two such servos, and working out the trigonometry of two connected lever arms, one on a servo fixed to the plane and one on a servo at the end of the fixed servo's lever arm, it should be possible to homebrew an XY plotter for less than \$100 by just buying two such model aircraft servos. Since I have no engineering specs yet on these devices, I can't say how accurate the plotter would be, but it would certainly draw! See figure 2. ■

YOU'LL SAY...

THANKS FOR THE MEMORY!

VECTOR GRAPHIC

WHY OUR MEMORY SHOULD BE YOUR MEMORY

1. Quality 2. Delivery 3. Price

ALTAIR & IMSAI COMPATIBLE 8K STATIC RAM SPECIFICATIONS:

- Access Time:** 450 ns - no wait states
- Current Requirement:** +5 to +10V at 1.6A worst case, 1.35A typical
- Memory Chips:** Prime components *plus two extras*
- Address Lines:** Fully buffered
- Memory Protect:** Hardware 8K
- Power Regulators:** 4 ea. 7805
- Address Select:** Dip switch accessible from top of board. No need to remove board to relocate
- Output Disable:** Permits use with transparent loader
- Board:** Quality G-10 material with solder mask both sides.
Pre-tested for etch bridges.

Order your 8K RAM kit for only \$265.00 +6% Cal. sales tax +3% hndlg. \$350 assmld., both incl. sockets.

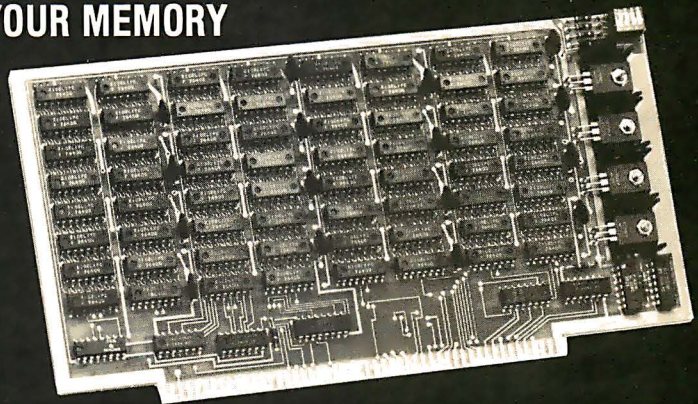

P.O. BOX 4784
THOUSAND OAKS, CA 91359
TEL: (213) 889-9809

VECTOR GRAPHIC INC. T.M.

A 6502 Op Code Table

Lemuel A Fugitt
11316 Linares St
San Diego CA 92129

Table 1: An explanation of the abbreviations used in the 6502 reference chart.

- abs: absolute.
- abx: indexed absolute using x register.
- acc: accumulator.
- aby: indexed absolute using y register.
- i,x: indexed indirect using x register.
- i,y: indexed indirect using y register.
- imm: immediate.
- imp: implied.
- ind: absolute indirect.
- rel: relative.
- zer: zero page.
- zpx: indexed zero page using x register.
- zpy: indexed zero page using y register.
- *: not implemented.

Here's a nice compact reference chart to help you debug those hexadecimal dumps from your 6502 microprocessor. To use the table, find the most significant digit along the top of the chart and follow the column down until you reach the value of the least significant bit of the hexadecimal code on the horizontal row. You now have not only the mnemonic but also the addressing mode being used. Table 1 is an explanation of the abbreviations used in the chart. ■

LEAST
SIGNIFICANT
4 BITS

MOST SIGNIFICANT 4 BITS

	0	1	2	3	4	5	6	7	8	9	A	B	C	D	E	F
0	BRK imp	BPL rel	JSR abs	BMI rel	RTI imp	BVC rel	RTS imp	BVS rel	*	BCC rel	LDY imm	BCS rel	CPY imm	BNE rel	CPX imm	BEQ rel
1	ORA i,x	ORA i,y	AND i,x	AND i,y	EOR i,x	EOR i,y	ADC i,x	ADC i,y	STA i,x	STA i,y	LDA i,x	LDA i,y	CMP i,x	CMP i,y	SBC i,x	SBC i,y
2	*	*	*	*	*	*	*	*	*	*	LDX imm	*	*	*	*	*
3	*	*	*	*	*	*	*	*	*	*	*	*	*	*	*	*
4	*	*	BIT zer	*	*	*	*	*	STY zer	STY zpx	LDY zer	LDY zpx	CPY zer	*	CPX zer	*
5	ORA zer	ORA zpx	AND zer	AND zpx	EOR zer	EOR zpx	ADC zer	ADC zpx	STA zer	STA zpx	LDA zer	LDA zpx	CMP zer	CMP zpx	SBC zer	SBC zpx
6	ASL zer	ASL zpx	ROL zer	ROL zpx	LSR zer	LSR zpx	*	*	STX zer	STX zpy	LDX zer	LDX zpy	DEC zer	DEC zpx	INC zer	INC zpx
7	*	*	*	*	*	*	*	*	*	*	*	*	*	*	*	*
8	PHP imp	CLC imp	PLP imp	SEC imp	PHA imp	CLI imp	PLA imp	SEI imp	DEY imp	TYA imp	TAY imp	CLV imp	INY imp	CLD imp	INX imp	SED imp
9	ORA imm	ORA aby	AND imm	AND aby	EOR imm	EOR aby	ADC imm	ADC aby	*	STA aby	LDA imm	LDA aby	CMP imm	CMP aby	SBC imm	SBC aby
A	ASL acc	*	ROL acc	*	LSR acc	*	*	*	TXA imp	TXS imp	TAX imp	TSX imp	DEX imp	*	NOP imp	*
B	*	*	*	*	*	*	*	*	*	*	*	*	*	*	*	*
C	*	*	BIT abs	*	JMP abs	*	JMP ind	*	STY abs	*	LDY abs	LDY abx	CPY abs	*	CPX abs	*
D	ORA abs	ORA abx	AND abs	AND abx	EOR abs	EOR abx	ADC abs	ADC abx	STA abs	STA abx	LDA abs	LDA abx	CMP abs	CMP abx	SBC abs	SBC abx
E	ASL abs	ASL abx	ROL abs	ROL abx	LSR abs	LSR abx	*	*	STX abs	*	LDX abs	LDX aby	DEC abs	DEC abx	INC abs	INC abx
F	*	*	*	*	*	*	*	*	*	*	*	*	*	*	*	*

DIGITAL DATA RECORDERS USING 3M DATA CARTRIDGES



Model 3M3
\$199.95



Model 3M1
\$169.95

BRAND NEW DESIGN

Featuring the radically new "UNIBOARD" method of construction for data cartridge drives. The major computer manufacturers are changing from cassettes to cartridges at a rapid pace because of freedom from binding and greater data reliability. Now, these professional type units are priced within the range of all data users. Being made primarily as OEM data storage units for the world's major manufacturers, these units, together with controller board and software ROM, are being made available to the individual user as well.

* Appearance and specifications may be changed slightly following acceptance tests now being conducted by OEM users.

MODEL 3M3 — Uses the 3M Data Cartridge, model DC300. This cartridge contains 300 feet of .250 tape in a sealed container. Records and plays at 9600 baud NRZ, 4800 baud P.E. Nominal speed 8" per second. Max. recommended flux density 1200 fcpi. Using four tracks, you can store nearly 2 megabytes of data on a cartridge. Cartridge measures 4" by 6". Turns counter indicates tape position. Inter-record gap light gives more accurate position. 2SIO(R) is not required for use, but is highly recommended for 8080 and Z80 systems.

COMMON SPECIFICATIONS: FULL SOFTWARE CONTROL of record, play, fast forward and rewind. LED indicates inter-record gaps. EOT and BOT are sensed and automatically shut down recorder. Can also be manually operated using the switches on top which parallel the software control signals when not under software control. Signal feedback makes it possible to software search for inter-record gaps at high speed. 117V — 60 Hz — 5 watts.

TWO I/O PORT CONTROLLER WITH ROM — Controls your terminal and one or two cassettes or cartridge units. On board ROM (For 8080 and Z80) has terminal and cassette software for turn on and go operation. NO MORE BOOTSTRAPPING. Plug in compatible with Altair and IMSAI. Loads and Dumps memory in Hex from the keyboard, formats tape files, punches tape, functions as a word processor and searches for files and four letter strings within files. Keyboard controls the cartridge units above on rewind and fast forward. Special keyboard codes enable you to dump and read Phase Encoded tapes as well as NRZ tapes. (Including K.C. Std.) Call routines give access to these from your software.

MODEL 2SIO(R) — With 1 ROM for NRZ Cassettes \$169.95
(Assembled & Tested) (Half of above Program)

With 2 ROM's for Data Cartridges and
P.E. cassettes. \$189.95 (Full Program)

Kits available for \$30 off above prices.

OVERSEAS: EXPORT VERSION — 220 V — 50 Hz. Write Factory or — Megatron KG, 8011 Putzbrunn, Munchen, W. Germany; Nippon Automation 5-16-7 Shiba, Minato-Ku, Tokyo; EBASA, Enrique Barges, 17 Barcelona, Spain; Hobby Data, SpireaVagen 5, Malmo, Sweden; G.Ashbee, 172 Ifield Road, London SW 10-9AG.

MODEL 3M1 — Uses the 3M Data Cartridge type DC100A. This cartridge contains 150 feet of .150 tape and is the same cartridge used by H.P. and others. Runs at 4800 baud NRZ, 2400 baud P.E. Tape speed adjustable, but nominally set at 5"/second. Maximum recommended flux density 1200 fcpi. Cartridge measures 2-1/8" by 3-1/4". This model is ultra compact, yet extremely capable. It is intended for word processing, mailing list use and other applications requiring the compact storage of data. Data location is by inter-record gaps and automatic file search. See Common Specs and 2SIO(R) below. 2SIO(R) is not required for use, but is highly recommended for 8080 and Z80 users.

For 8080 and Z80 users: Comes complete with software program listings for the programs on the 2SIO(R) ROM below. 6800 software is being written, but not yet completed. These programs give **FULL SOFTWARE CONTROL**.

CARTRIDGE AVAILABILITY: Cartridges are made by 3M, ITC, Wabash and others. They are available at all computer supply houses and most major computer service centers. We can also supply them at normal current list prices.

NEW: AUDIO CASSETTE INTERFACE* Phase Encoding interface for use with audio cassettes or NRZ recorders. Runs 2400 baud phase encoded on good quality audio cassette recorders. May also be used with 2SIO(R) above to use the 2SIO(R) cassette programs with your audio cassette player. Can also accommodate "Tarbell" tapes and K.C. Std. tapes.

\$50.00, Wired & Tested. — \$35.00, Kit Form.

*NOTE: You do not require an interface with the 3M1 and 3M3 unless you Phase Encode. But, you do need an interface to use the 2SIO(R) with your own audio cassette.

"COMPUTER AID" and "UNIBOARD" are trademarks of the NATIONAL MULTIPLEX CORPORATION. The 3M Data Cartridges are covered by 3M Patents and Marks. "UNIBOARD" Patents Pending.

For U.P.S. delivery, add \$3.00 each item. Overseas and air shipments charges collect. N.J. Residents add 5% Sales Tax. WRITE or CALL for further information. Phone Orders on Master Charge and BankAmericard accepted.

NATIONAL MULTIPLEX CORPORATION
3474 Rand Avenue, South Plainfield, N.J. 07080, Box 288
Phone (201) 561-3600 TWX 710-997-9530

The Digital Cassette

Jack Breimeir
 The Economy Co
 1901 N Walnut
 POB 25308
 Oklahoma City OK 73125

Ira Rampil
 917 Engineering Research Bldg
 University of Wisconsin
 Madison WI 53706

We've now seen an illustration of the techniques involved in the recording and playback of binary strings on magnetic tape (in part one last month). These techniques are all that would be required if the cassette tape transport mechanism had instantaneous start and stop, and perfect speed regulation. The read and write electronics would need to have very wide bandwidth, as shall be seen later, and the tape itself would have to be absolutely error free. Since there are problems in meeting each of these requirements, a great deal of effort has gone into data code conversion schemes that tend to alleviate the problems. Many different codes have been developed, but only a few have found widespread application and usage. The number of codes in use, in fact, is likely to decrease in coming years, as there are strong incentives in the industry to settle on standard coding schemes which would then be used by everyone. There is no urgent reason, however, for amateurs to embrace the industrial standard, especially if there is no intent to exchange tapes using the medium.

There are several specific qualities to examine when selecting a coding scheme. Dr A E Whitehouse of the Dept of Computer Science, University of Manchester, in his doctoral thesis, selected the following seven characteristics inherent in each scheme to which relative ratings can be assigned. These criteria are the column headings of table 1, which compares a number of coding schemes.

1. Bandwidth: The range of frequencies required to be passed by the read or write amplifiers for a given rate of data throughout should be minimal. Most importantly, low frequency response requirements should be avoided because
 - a) low frequencies contain much noise like rumble, wow and flutter, and

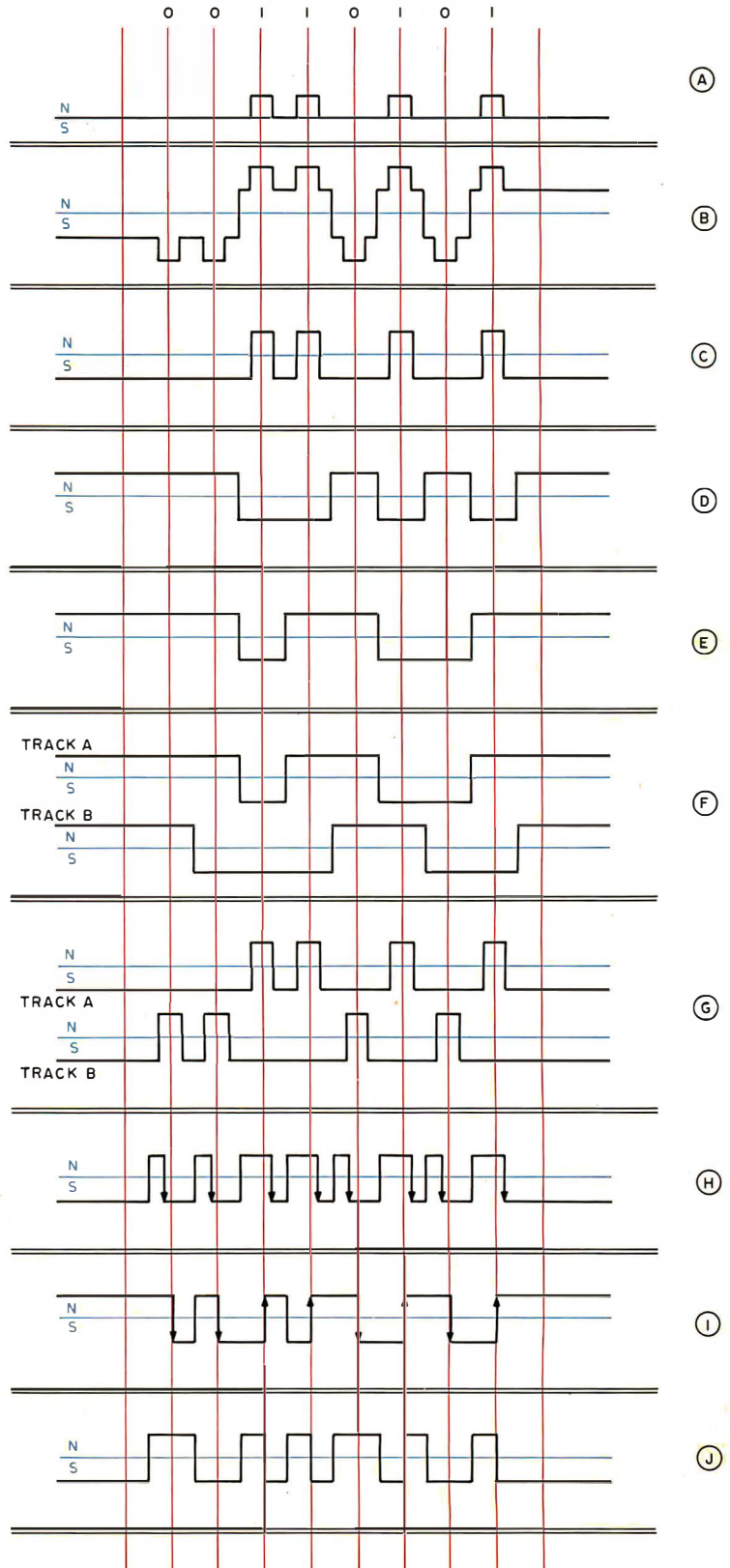

Subsystem:

Part 2,

Digital Data Formats and System Considerations

- b) difficulties in design of the read electronics. In general, the narrower the signal bandwidth, the better the signal to noise ratio. [Compare NRZ (nonreturn to zero) and PE (phase encoding) methods of encoding as seen in figure 1.]
- 2. Circuit Complexity: The cost of any system is proportional to its complexity. However, as can be seen in table 1, there are many performance trade-offs that improve with increasing complexity.
- 3. Efficiency: The efficiency of a code is a measure of data density produced by it. Efficiency: = $100 \div (\text{flux changes per bit})$
- 4. Inter Symbol Correlation: For the best performance, the codes used to represent binary ones and zeros should be as different from each other as possible. One hundred percent correlation occurs when the symbols used for ones and zeros are equal and opposite.
- 5. Noise: A qualitative measure of sensitivity to tape noises such as drop outs.
- 6. Read Resolution: The percentage of time in each bit that is allowed in order to decide whether it is a one or a zero.
- 7. Self Clocking: Does this code inherently provide its own bit rate clock for data reconstruction? If not, an external clock must be provided and

Table 1: Comparison of magnetic media encoding formats. This is an overall chart of several different characteristics; several of the methods are discussed in more detail in the text. In the waveform samples, the vertical lines mark data bit times, and the horizontal reference line separates north from south magnetization (or vice versa).

Code Name	Number of Data Tracks	Sample Wave-forms	Signal Band-width	Circuit Complexity	Storage Efficiency	Inter-symbol Correlation	Noise Immunity	Resolution	Is It Self Clocking	Transport Speed Limitations	Applications and Comments
Return to zero (RZ, RZ pulse)	1	-A-	wide	simple	50%	50%	poor	poor	no	strict	Of historical interest, not self erasing
Bipolar RZ	1	-B-	medium	moderate	50%	100%	poor	poor	yes	lenient	Of historical interest only
Return to bias (RB)	1	-C-	wide	simple	50%	100%	poor	poor	no	strict	Of historical interest only
Non return to zero (NRZ, NRZ1, NREC)	1	-D-	wide	simple	100%	100%	fair	100%	no	strict	Used on older 7 and 9 track commercial magnetic tape drives
NRZ-mark (NRZM, NRZ1)	1	-E-	wide	simple	100%	75%	fair	100%	no	strict	Used on contemporary commercial tape drives
Complimentary NRZ (CNRZ)	2	-F-	wide	simple	50%	fair	fair	100%	yes	very lenient*	Incremental recorders and data loggers, calculator strip recorders.
Complimentary RB (CRB, 4 phase)	2	-G-	wide	simple	25%	50%	good	good	yes	very lenient*	Off line terminals; uses much tape due to low efficiency
Pulse ratio recording (PR, PW, SRT)	1	-H-	medium	moderate	33%	good	good	>=50%	yes	tolerant of slow drifts	Useful on hub driven tape drives (eg: Redactron)
Phase Encoding (PE, split phase, Manchester II+180)	1	-I-	narrow	complete	50%	100%	good	75%	yes	tolerant of fast and slow change	Currently the industry standard for all tape systems, commonly used for floppy disks.
Manchester I (also PE)	1	-J-	narrow	complex	50%	100%	good	75%	yes	tolerant of fast and slow change	Same as above.

* Note: Two channel recording methods are lenient with respect to speed variations, but have tight head skew requirements which do not exist for single channel recording methods.

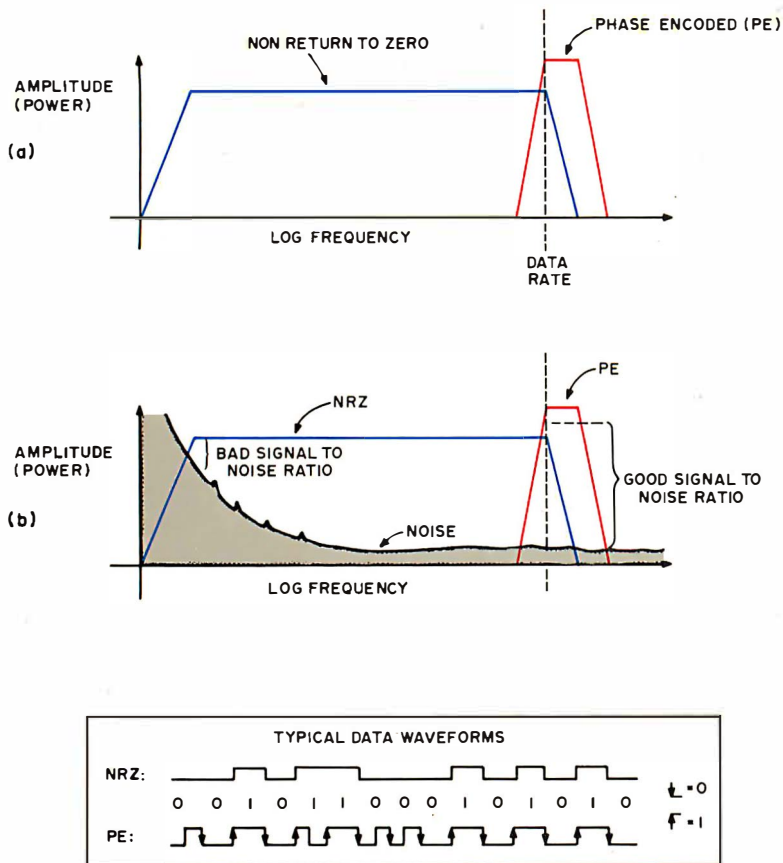

Figure 1: Frequency spectrum requirements for a practical system depend upon the nature of the encoding and the noise characteristics. At (a), two common encoding methods, non return to zero (NRZ) and phase encoded (PE) data are shown as a spectrum of amplitude versus frequency. NRZ requires a flat response virtually from zero frequency up to the data rate. PE requires a frequency band response characteristic of one octave in the vicinity of the data rate. Looking only at the signal, and knowing electronic design rules of thumb such as the one that it is easier to make a narrow band amplifier than a wide band one, PE looks like a better method. Then, adding in a system noise characteristic as at (b), it becomes obvious that PE or any system with limited bandwidth is to be preferred over NRZ. NRZ is the simple method to generate (it is just a time ordered stream of data bit values), but its signal to noise ratio runs into problems due to noise at the low frequencies.

since it is asynchronous to the data, this code cannot be used reliably at high data rates.

For additional information beyond Whitehouse's criteria, two extra columns have been added to table 1.

8. Tape Transport Limitations: What requirements does this particular code place on tape speed accuracy and stability?
9. Usual Application: These various coding schemes present different trade-off balances, and therefore have found themselves in a wide variety of different applications. A typical application is presented for each code.

To efficiently analyze the entries in the table, it is possible to divide them into two groups. The division concerns the number of tracks required to write or recover data. Some codes require two channels of recording to recover one channel of data. These codes are, for the most part, older and space inefficient techniques. The advantage in using them is that the coding circuitry is relatively simple and these codes tend to be very speed tolerant. For the amateur, however, the cost reduction in logic is more than offset by the additional cost of a two track tape head, an extra signal processing channel, and the problem of intertrack head misalignment or head skew as illustrated in figure 2. Therefore, with the advent of quality low cost tape transports and speed tolerant one track codes, it is wisest to stick with single track recording. There is an exception called "mark track" recording which will be discussed later. There are four techniques which have found application among amateur applications.

Non Return to Zero (NRZ)

Conventional NRZ consists of recording a constant saturated level for the duration of the bit. For example, a string of ones input to the cassette will be recorded as a constant north magnetic level which will persist until a zero occurs in the input string. Obviously the efficiency is high; there is a maximum of one transition per bit, usually less. The possibility of long strings of either zeros or ones requires that the signal processing chain have a very wide bandwidth, extending down to near zero frequency. Another problem with this system is that it is not self clocking, therefore an asynchronous receiver such as a UART must be used to convert the output of the tape back to synchronized parallel bytes. Assuming a very stable tape speed, both in the long term and short term, this technique is limited by tape noise, the magnetic data transfer head, and the limiting speed of the UART. There is a way of improving the reliability of asynchronous NRZ by making it synchronous: Recording a separate clock track at the data rate while simultaneously recording data in another channel provides a means of synchronously gating the data at playback, thus eliminating the need for a UART (assuming skew is not a problem). The National Multiplex Co of South Plainfield NJ provides amateur digital cassette recorders using NRZ or clocked NRZ at up to 2400 bits per second; they also sell NRZ electronics boards that can be planted in an ordinary audio tape recorder. This product is capable of up to 4800 bits per second, depending on tape speed.

Complimentary Return to Bias (CRB)

Complimentary return to bias is a two track technique which resembles the RB code. In RB each data cell has a binary state, north or south, and so in two track CRB each data cell is set to one of four states:

1. Both tracks at south
2. Track A at south, track B at north
3. Track A at north, track B at south
4. Both tracks at north

State 1 represents a "no data" condition as in an inter record gap. States 2 and 3 respectively represent zero and one. State 4 is a framing signal which can be used to represent conditions like end of block or end of byte. This code is both noise and speed tolerant. Its clock signal can be derived from a simple OR of both tracks, since except in state 1, there are transitions every bit. This code, however, has poor utilization of available tape. In other words, it is a low density technique and the bandwidth is even wider than for NRZ. As a two track technique it is subject to skew problems. The circuitry to implement CRB is a fairly simple logic network.

Pulse Ratio Recording (PR)

In the pulse ratio coding method each data cell uses two flux transitions in three possible locations. The first flux transition of each cell is a positive transition, from south to north. Its presence defines the beginning of the data cell and gates a clock on. The contents of the data cell, ie: the bit, is determined by the percentage of time spent at north as compared to south, within each data cell. There is a very simple method to decode PR by the use of a bidirectional counter in hardware or software. The previously mentioned positive flux transition starts the counter going up. The next flux transition is of course a negative one. Its arrival switches the mode of the counter into down counting. The transition after that is the clock pulse for the next cell; it resets the counter and clocks out the contents of a flip flop which records the possible transition of the BORROW output of the counter — then the process starts over. It is the borrow signal which contains the data in the cell. If for a one bit, as in table 1, the north time was greater than the south time, then the counter result is a positive number; no borrow was required and the flip flop holds a one, the contents of the cell. A zero on tape has a longer south time than north time: The counter going into underflow drops the BORROW to zero for one clock cycle. The flip flop records the drop and holds a zero. This method provides excellent

resistance to long term speed variations, provided the counter has enough precision. The bit-to-bit jitter resistance, however, is not so good due to the less than 50% read resolution. This resistance and resolution can be improved by accentuating the pulse width difference; but then noise immunity suffers because the bandwidth goes up. This technique's primary advantage is that the circuitry is the simplest for a one track self clocking code.

Phase Encoding (PE)

Phase encoding has been selected by all of the relevant standards organizations as the way to go. Most commercial manufacturers provide a PE option for their cassette decks sold to original equipment manufacturers (OEMs). The most widely used form of PE, also known as "split phase" or "Manchester II +180" is a single track, self clocking technique. The definition of the code places two landmarks in each data cell. The landmarks are actually times during a data cell when transitions are made in the tape magnetization level. The data is actually stored in the direction of the magnetic transition at the midpoint of the cell. This transition occurs at "data time" and is specified as south to north for a one, and north to south for a zero. In order to assure that the magnetic signal will be at the right

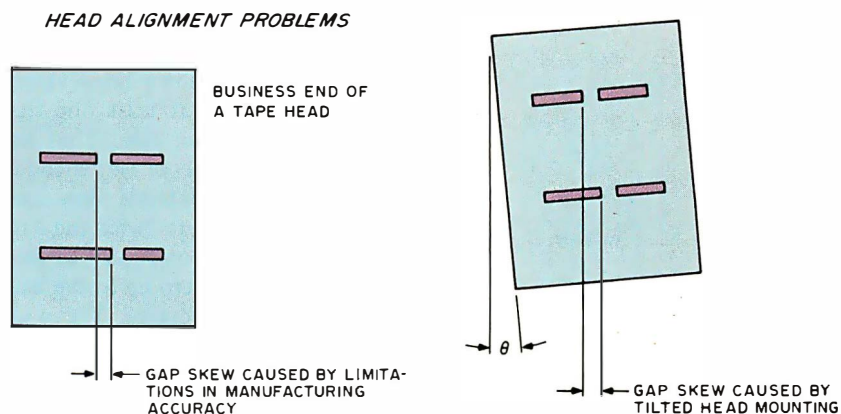



Figure 2: Head alignment and manufacturing tolerances cause a phenomenon called gap skew in multitrack heads. At (a), the tolerances in manufacturing of the head itself cause one component of skew. At (b), a second source of skew is due to the fact that the head may not be perfectly mounted relative to the tape. The tilt causes a skew between otherwise perfectly manufactured gaps. The actual skew measured is a combination of both effects. The picture is exaggerated, but a small misalignment of, for example, 0.005 inch (0.13 mm) means a difference of 200 ms in the relative timing of two tracks being read at 25 inches per second (64 cm per second). A typical manual for a tape drive unit will warn the controller builder to put in circuitry to compensate for intertrack skew totalling several bits if parallel data is used. This skew problem argues strongly in favor of single track recording techniques.

Sample Circuitry for Several Different Coding Techniques

This circuitry assumes that the tape deck write head is driven directly for output, and that tape input signal processing electronics produces the + and - flux transition clocks (low going ) as output. Encoding consists of preparing the proper signal to drive the write head from NRZ data, and decoding consists of converting the flux transition information back into NRZ data, possibly along with clock information derived from the tape.

a) NRZ coding. The output NRZ data simply drives the head directly. A UART or other asynchronous data format must be used for the parallel to serial conversion, and clock references used in writing are assumed to be

valid within a few percent when reading the data back, hence the tight tolerances on speed. Decoding of the flux transition clocks is done simply by driving an RS flip flop.

b) NRZ1 coding. The output NRZ data is converted to NRZ1 by using it to gate the clock driving a toggle flip flop (here a JK flip flop set up to toggle). The input flux transition data is converted back to NRZ by using the logical OR of the two transition clocks to drive a retriggerable oneshot with period (R and C) set up equal to the bit period. The fixed width of this oneshot also makes this method highly speed dependent.

c) PE coding. The output PE data is generated

polarity for the next data time, an additional transition can occur if needed at "phase time." Phase time occurs at the beginning of each data cell. The phase transition occurs at phase time only if the preceding bit is the same as the bit to be written. The phase bit is ignored by the read circuitry except for clocking purposes. In the inevitable comparison of phase encoding with non return to zero, it first appears as though non return to zero provides high bit density per unit length of tape. True, phase encoding is less space efficient than non return to zero, requiring the time budget of two flux transitions per data bit compared to one flux change per bit. There are, however, extenuating circumstances which throw the balance in favor of phase encoding. The advantages come from phase encoding's requirement that each data cell have at least one flux change and not more than two. Thus the bandwidth needed for a phase encoded signal processing chain extends only one octave, from the data rate to twice the data rate. The bandwidth for non return to zero electronics extends from zero up to the data rate, possibly 5 to 10 octaves. The wide range of flux change frequencies also wreaks havoc on peak shift and amplitude fluctuation phenomena due to the tape itself. As we saw previously, peak shift and amplitude fluctuation cause problems in the recovery of raw bit strings from the tape. These phenomena are well defined in phase encoding: Their effects are small and easily compensated. Self clocking is another side benefit of having at least one transition per bit. A very simple form of self clocking derived from phase encoding is a monostable set to the data rate. Triggered by each data transition, its output provides clock gating for each previous data bit. More sophisticated techniques which have great tolerance for tape speed variation and noise involve

tracking oscillators or phase locked loops. Such systems will compensate for missing pulses by providing clock pulses of their own if the tape messes up momentarily. Phase encoding requires that the first byte written in each block be a preamble word consisting of 8 data transitions like the byte 01010101. The preamble allows time for the phase locked loop to get into lock step with the data rate. Block diagrams for various forms of data encoding and recovery will be illustrated later.

Since they have now appeared on the personal computing market, a few words are in order concerning GCR, Group Coded Recording. GCR is different from the previously discussed codes in that here code bits do not bear a one to one correspondence to their input bits. Instead, a code converter ROM, like an ASCII to EBCDIC converter, transforms each parallel input group into a slightly longer output group which is then put on the tape. Playback involves the opposite process. This type of coding was originally developed for ultra high performance nine track drives and combines the best features of phase encoding and non return to zero. The circuitry, however, is very complex.

Error Detection

There is no easy and cheap method for self correcting data errors that occur on tape read operations. There are redundant data techniques which would work but at a great sacrifice in data throughput. On the other hand, there are several ways of detecting errors. This is almost as good as correcting the errors, since about 9 out of 10 errors are soft errors; that is to say they disappear upon retrying the read. Only about 1 in 10^7 to 10^9 bits read result in a hard, or permanent, error. There are also two very

from NRZ data using a clock at twice the data rate, and the NRZ data itself. Two methods are shown here, one which can be built from gates, and a second using an RCA CD4037A integrated circuit. The input de-

coding methods can range from the simple oneshot method shown here to complicated phase lock loops which are much more error resistant. For the oneshot version, ΔT should be set to be 1.5 bit cells.

(a)

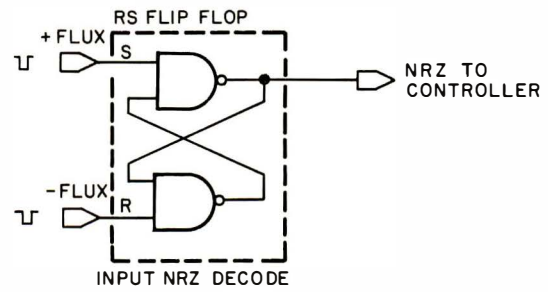
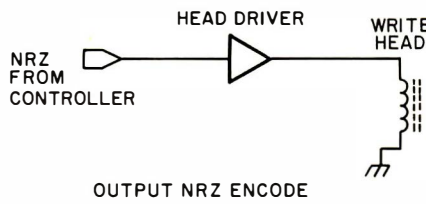

(b)

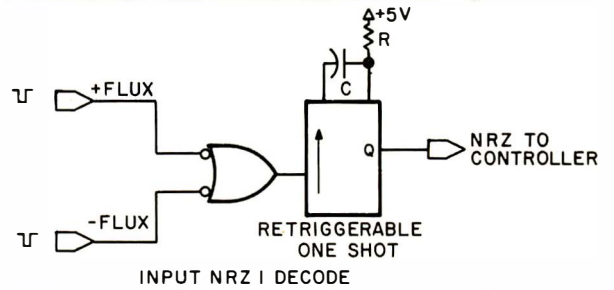
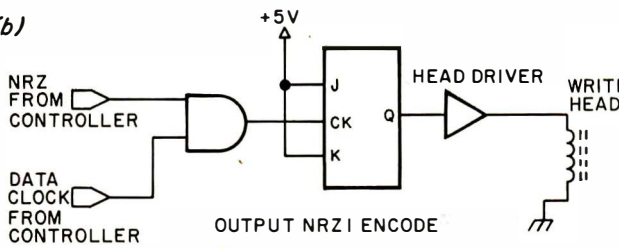

(c)

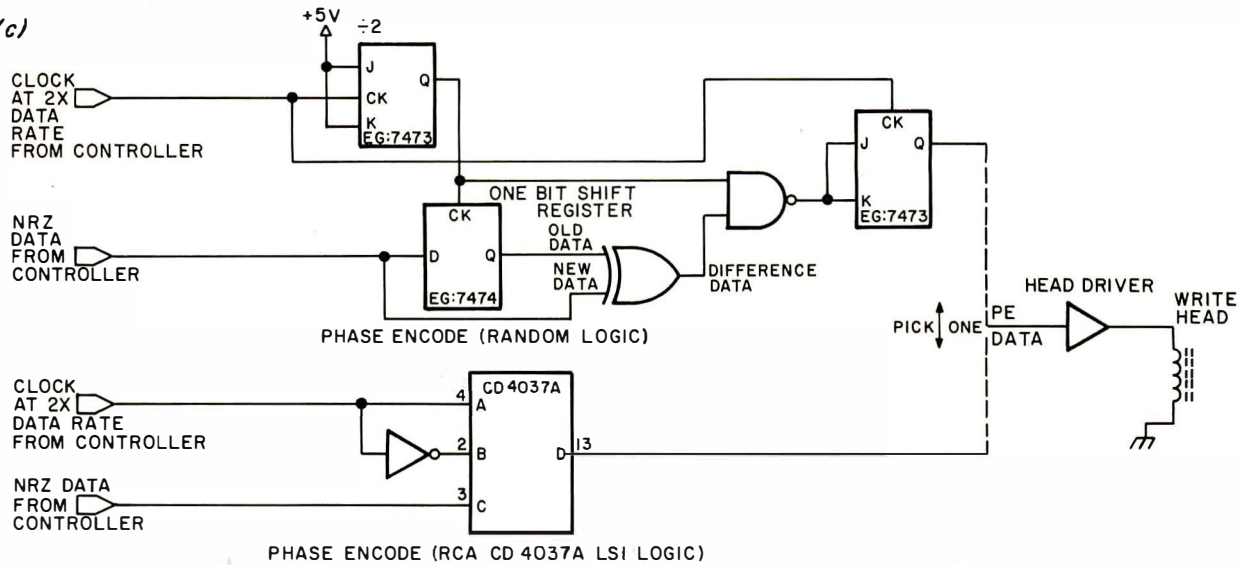

PHASE ENCODE (RCA CD 4037A LSI LOGIC)

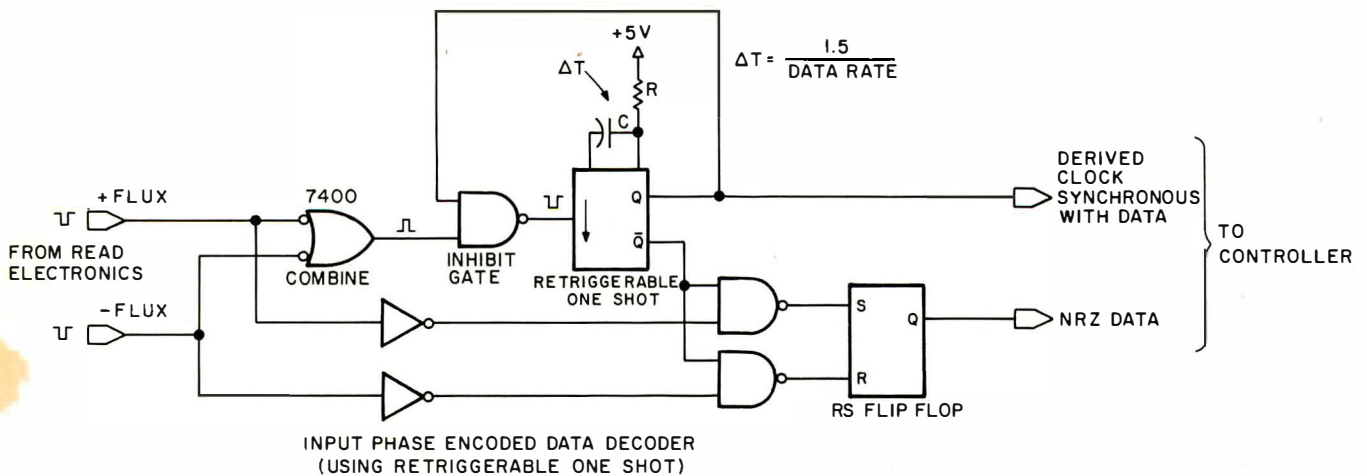

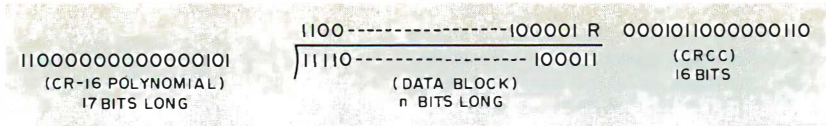

Figure 3: A hypothetical cyclic redundancy check polynomial division. In a CRC calculation, the data is divided by a 17 bit cyclic redundancy polynomial to yield a result and a 16 bit remainder term. It is the remainder term which is used as the check word for error detection. The beauty of the whole method lies in the fact that it is very easy to perform the division in hardware, one bit at a time as the serial data goes flying by. There are even LSI circuits which can be used in the hardware of a controller and formatter device.

inexpensive precautions to take to prevent errors:

1. Keep all tapes immaculately clean. Don't ever smoke in their presence. The smoke particulates are murder to magnetic tape.
2. Always rewind tape before removing from the drive. This helps prevent dirt and crinkles from affecting the tape.

Three methods of error detection particularly apply to cassette operations. Only one method need be used at a time. The first technique is the commonly used parity bit. A parity bit is simply an extra bit tacked on to each byte of data. An odd parity system sets the parity bit to one if the one's complement sum of the data bits in the byte is equal to zero. In other words, the parity bit is set equal to one if there is an even number of one bits in the data byte. During a read operation, a new parity bit is generated

and compared to the parity bit written previously on the tape. If they are different there is an error somewhere. The disadvantage of a parity check is that it will not detect an error if an even number of bits in a single byte is wrong. Another disadvantage is that a parity bit per byte eats up 11.1% of the available room for data. For blocks longer than 16 bytes, there are more efficient techniques which use two bytes per block regardless of block length. These techniques are the checksum word and the cyclic redundancy check (CRC) word. The checksum technique simply sums all the data in the block, byte by byte, modulo 2. The resultant n bit sum is written on the tape as the last information in a block. During a read operation, the data is again checksummed as it enters the computer and the new result is compared to the sum on tape. Again, a mismatch indicates an error has occurred somewhere along the line.

Although the theory of cyclic error codes is somewhat complex for discussion here, the following is a fairly simple explanation of how cyclic redundancy checks work. Consider any random block of data to be a binary polynomial of degree N, where N + 1 is the number of data bits in the block. A CRC check is performed by serially dividing the entire data block (modulo 2) by a binary polynomial of degree 16. Such a polynomial could look like "1100000000000101," which happens to be the standard CR-16 polynomial otherwise represented as $X^{16} + X^{15} + X^2 + 1$. This division process is

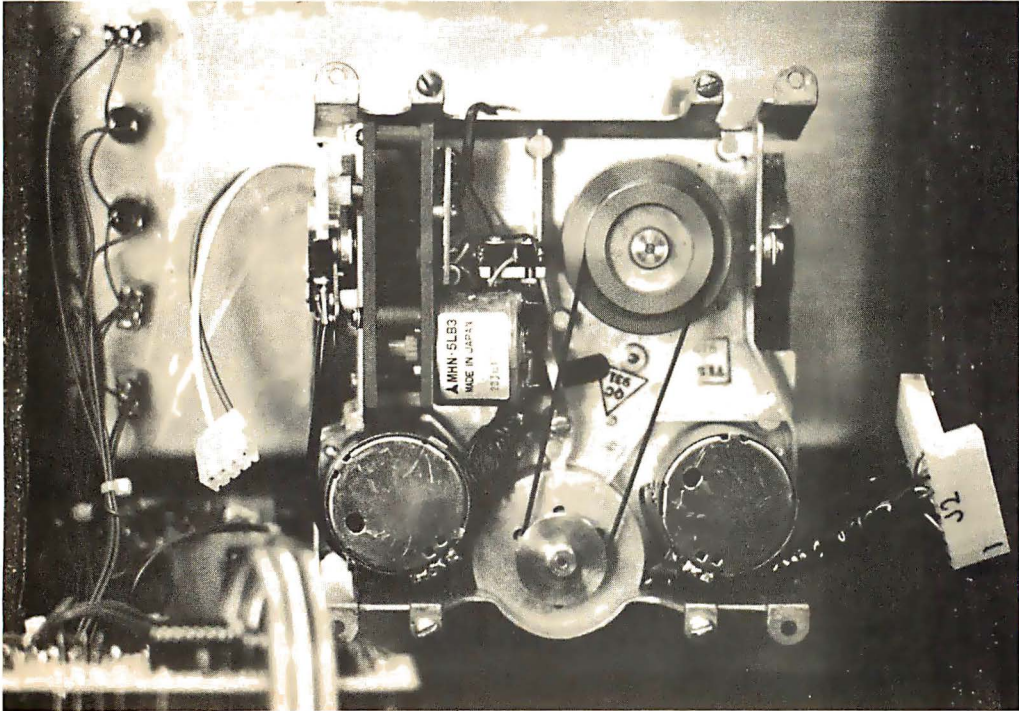

Photo 1: The works of a Phi-Deck mechanism, viewed from the rear. The four DC motors of the drive can be seen in this photo: Two are used as direct drive for the tape reels, one drives the tape capstan via the pulley and belt arrangement seen, and the third drives a gearbox which actuates the tape head engage mechanism. For a view from the front, see photo 2.

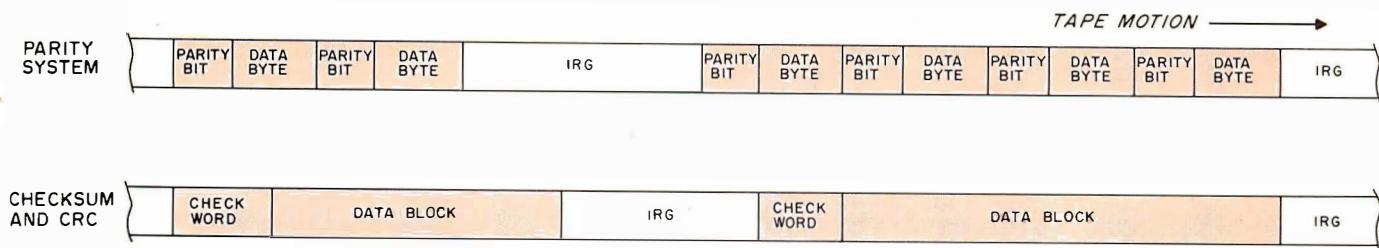

Figure 4: The relationship of error detection data to data constitutes the beginning of a format for the tape data. In a parity system, each data byte has an extra parity bit associated with it, and blocks of data are just groups of such data and parity combinations between inter record gaps. In a checksum or cyclic redundancy check system, the data bytes have no detail error detection code associated with them and a single check word, with enough bits to guarantee error detection given the size of the block, suffices. Cyclic redundancy checks are easily generated in hardware, and checksums are the easier route given software as the means of error detection.

illustrated in figure 3. Each unique data block generates a unique 16 bit remainder term after division. The remainder word, or cyclic redundancy check character (CRCC), is written out to tape and is compared to the CRCC freshly generated during a read operation. Once again, a mismatch signifies an error. A CRC generator and checker can be implemented in either hardware or software. Several manufacturers such as AMI, Motorola and Signetics offer LSI chips which do the whole job in one package containing a shift register and some gates, so CRC is best left to hardware. CRC with the 17 bit polynomial is capable of detecting any number of single bit errors and a large portion of any "burst" (multibit) errors that occur in a block less than or equal to 4096 bits long (for a 16 bit cyclic redundancy check code). CRC is fast becoming a standard for floppies and commercial cassette equipment due to its ease of generation in hardware.

The relationships of the error detecting codes to the data they protect is illustrated in figure 4. It is important to keep in mind the completely serial nature of such single track recording.

Tape Transport Hardware

The choice of hardware is another place in which many alternatives are possible. Ordinary audio cassette decks have excellent speed regulation, but they have low tape speed; and included in their price are expensive audio recording and playback amplifiers which are not needed for digital service. In addition, rare is the audio deck which permits digital control of the mechanism. Most decks designed for digital service have good speed regulation, high tape speed, and full digital control of tape motion. Their problem, in terms of amateurs, is price. The majority of digital cassette decks start in the vicinity of \$500 for the deck itself and a circuit board with the motion control logic.

Some decks provide tape transfer heads with preamps on the read side; some do not. Most manufacturers offer at additional cost a data encoding and decoding board. Power supplies, although usually trivial, are not cheap. Fortunately, there are currently available several inexpensive cassette decks which meet all of the requirements for digital service. One such unit is the Phi-Deck, from the Triple I Company, which has a current price tag, for the same package mentioned above, of between \$200 and \$300. The deck itself was originally designed for audio use in a language lab environment where remote control and good speed regulation are important factors. With the addition of regulated high speed (up to 20 inches per

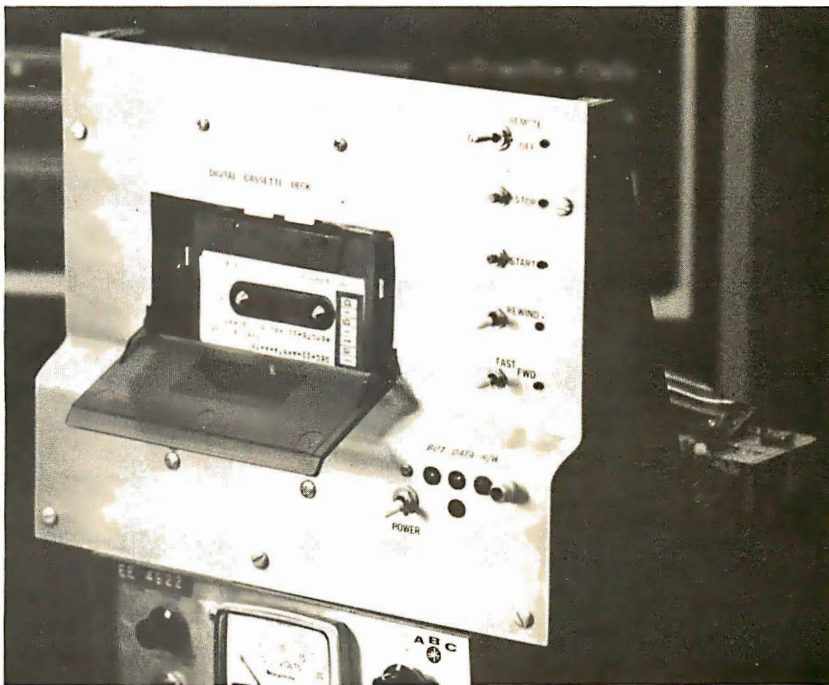

Photo 2: Ira Rampil's homebrew mount for the Phi-Deck mechanism he will be using with his PDP-11/20 system as a mass storage file subsystem.

second), the deck is fully adequate for digital use. Since the Phi-Deck is representative of a large class of deck hardware and is itself likely to be the first choice of personal computing equipment designers, a few words could usefully be spent in a description of the deck.

The Phi-Deck obtains its speed regulation from a tape capstan as do audio decks. Many other digital decks use a hub to hub drive technique which then requires a servo loop for speed regulation. The capstan is controlled by a separate motor, as are each of the reels. The head is also controlled by a separate motor to engage and disengage it from the tape. A motion control board receives signals from the processor such as forward, rewind and stop. It converts these control signals into the proper sequence of voltages to control the small DC motors. The control board also relays back to the processor various status lines to confirm that the deck is operating as instructed. The innards of the Super Phi-Deck are pictured in photo 1; photo 2 shows a Super Phi-Deck in a mounting designed by author Rampil for use in his personal PDP-11 based system. Figure 5 illustrates the deck in its relationship to the rest of a cassette memory system.

Data Formatting and Applications

Once a means of recording and recovering data on cassette tape is secured, some decisions must be made on the formatting or layout of data on the tape. There is a wide variety of possible formats. The one to select depends on the application. Whatever the

application, the overall tape format should be as represented in figure 6: clear leader, blank tape, strings of recorded data separated by inter record gaps (IRG), blank tape, and finally clear trailer. Certified digital cassette tapes and cartridges have small holes punched in the tape at the beginning and end of the usable magnetic surface. Essentially, the application dependent variable is the way the data is grouped on the tape. Grouping data into blocks is a key feature of most tape memory systems.

The concept of blocking began as logical records being stored as separate entities on tape. Storing an entire program, for example, as a contiguous string of data separate from other logical records, has some merit. A block has clearly defined starting and end points, and thus eliminates word by word searching through an entire tape to find and process a particular program. As the hardware and the operating systems grew in sophistication, the concept of buffering was applied to input and output operations. Buffering is the process by which data from the outside is first read into a dedicated area of main memory by a monitor program, checked over, and then forwarded to the program which initially requested the data transfer. For example, if a program wishes to read some data points from the cassette memory, a subroutine call is placed to the monitor program requesting the read, the monitor does all the work of finding and reading the data, checks it for errors, and then relocates it to the appropriate locations inside the requesting program's memory

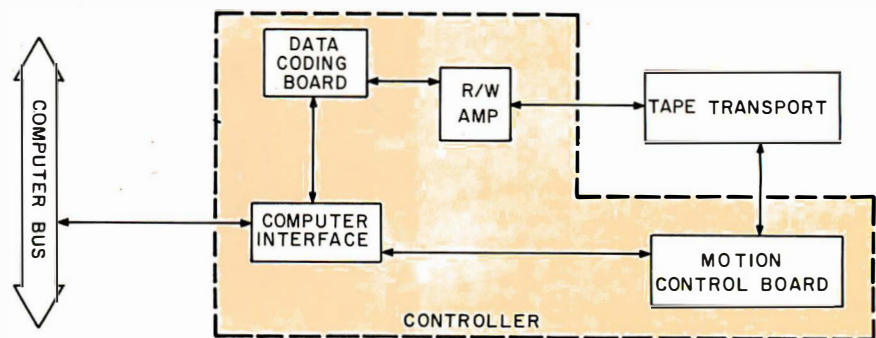

Figure 5: An overall block diagram of a digitally controlled magnetic film memory subsystem. The addition of complete tape motion control and use of direct digital recording make such a Philips cassette subsystem a vast improvement over the manually oriented lower speed audio versions of tape mass storage. Functionally, this same block diagram applies whether the drive is for a reel to reel tape, a Philips cassette, a 3M cartridge or other magnetic media. The next step up in terms of performance (and price) is probably a floppy disk. A floppy disk subsystem has a very similar arrangement, but a slightly more complicated motion control section needed to manipulate its movable head.

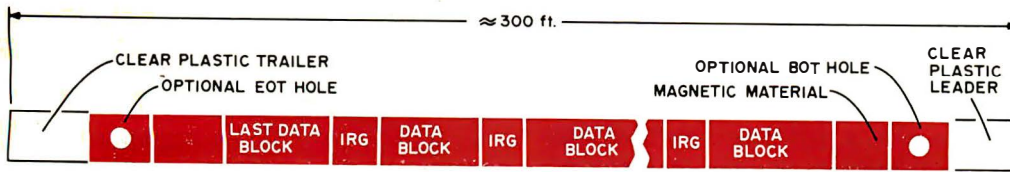

Figure 6: The anatomy of a Philips cassette recording. At the beginning and end of the tape is a clear plastic leader area. The magnetic tape (symbolized by the black area with dropped out lettering) has an optional EOT (end of tape) hole at each end. Data is typically grouped into blocks, separated by inter record gaps (IRG) which are erased regions without data. The content of the blocks is specified by software and hardware depending upon the particular system used.

space. Although the advantages of buffering IO are beyond the scope of this article, it should be sufficient to say that they are important. Except in very large commercial machines, buffer areas are seldom large enough to contain an entire program as a single logical record. Therefore, logical records are often broken up into several smaller blocks on the tape. Not only is the requirement for buffer memory reduced; but in addition, error handling is easier. Conversely, if the logical records are very small, for instance, one output character data, the buffering software collects several outputs together and ships it out to the tape as one block. The number of logical records per tape block is known as the blocking factor. Effective blocking represents a compromise between the smallest buffer area and the maximum tape utilization, ie: the minimum number of blocks and their associated inter record gaps. A graph portraying the approximate relationship between the length of data blocks, assuming they are all the same fixed length, and the total data capacity of a C-30 cassette is presented in figure 7.

The simplest application lends itself to the simplest formatting. A digitally controlled cassette system or manually controlled system may be used as an inexpensive substitute for a high speed paper tape reader punch. In fact, several manufacturers offer cassette systems that are plug compatible with paper tape equipment. The data is blocked byte by byte, or not at all. Since there is no file structure, the data appears on the cassette exactly as it would on paper tape. There is no need for inter record gaps between bytes in this format, for by placing very long gaps between logical records on the order of a foot or two of tape a human operator can locate a particular logical re-

cord with the aid of a tape counter mechanism, just as an audiophile would find a particular song. A UART is a very neat way to generate the parallel-serial data conversion for this byte oriented format. The disadvantage of using a UART here is that it adds at least three extra bits, start, stop and parity, to every byte thus reducing the data density on the tape.

For more efficient and useful operation, a file structure should be added to the digi-

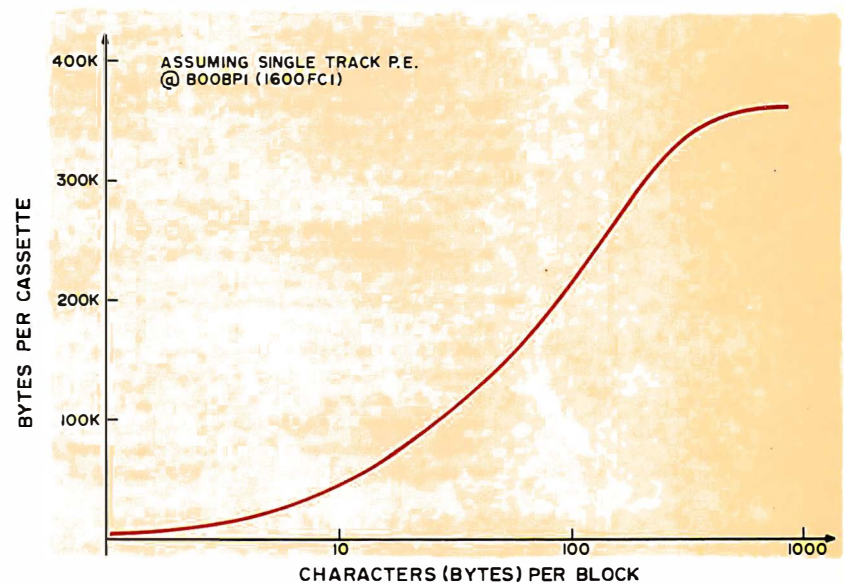

Figure 7: Cassette capacity versus block size. The inter record gap (IRG) is essentially wasted space on the tape. By increasing the size of the block, the percentage of tape wasted on IRGs declines toward a limit of zero. As the size of the block is decreased (ultimately to its limit of a single byte separated by IRGs on either side) the total number of bytes available on a tape declines. For any given set of parameters (inter record gap length in inches, flux density in bits per inch, and data format), the total useful data per cassette can be calculated and plotted as one point on a curve such as this.

tally controlled transport. By blocking the data into chunks of convenient size with identification information, software can then examine each buffer as it is read in to search for any particular file (a group of such blocks) on the tape. A file is considered to be a single logical record even though it might cover many blocks. In a file structured system with a remotely controlled tape deck, keyboard commands or commands generated by a program replace manual intervention and the automatic operations make the system much more convenient. Still lacking, however, is a very useful block replacability feature since there is no way to synchronize the start of overwriting with the

beginning of a data block, especially if the drive has stopped in the preceding gap. Although it is not possible in this system to overlay a corrected or updated program into the space it formerly occupied, it can easily be added on to the end of the tape.

Musings on the Ultimate

The ultimate cassette memory system incorporates block replaceability and sector addressing to simulate random access storage. The technique proposed here for Phi-Decks is similar to that used so successfully by Digital Equipment Corporation in their DECtape units. In fact the Sykes Corporation developed and marketed such a system for cassettes until their attentions turned to floppy disks. The trick is use one track for normal phase encoded or pulse ratio data and a second track as a prewritten mark track. The mark track is first written to initialize the tape and it is only read thereafter. It contains, in the same code as the data track, various sorts of delineators, or marks, and also the block address numbers of the data blocks residing on the adjacent data track(s). Data is written in fixed sized blocks in synchronization with the areas designated by the mark track. By observing the transitions on the mark track, the tape controller will have no difficulty in overlaying or replacing previously written data. The advantage of including block numbers on the mark track is that as they are read in, they can easily be compared with a register containing a block number being sought, thus eliminating the need for a software search program. Usually a directory data block is included on the tape, most frequently as the first data block. Its contents generally include the file names and their starting block addresses. When a cassette is first mounted in the drive, its directory is read in. Whenever the computer needs access to a tape file, it gets the block address from the directory and initiates a hardware search. Each time a change is made to the tape, the directory copy in memory is updated and a copy of it is written back to the tape. Using one's imagination, many different file manipulations are possible with such a system. Anything possible with a floppy disk operating system is in fact possible with a mark track cassette system. The tradeoff is just time versus price. A floppy is essentially instantaneous, from a human standpoint. A cassette system takes from seconds to a few minutes, at about one fourth the price of a floppy. Even with these time constraints, a full digital cassette system is a lot less painful than Teletype paper tape or audio cassette. ■

FOR FURTHER READING

Books

- Bycer B B, *Digital Magnetic Tape Recording: Principles and Computer Applications*, Hayden Co, NY 1965. This book has an excellent introduction to the theory, but the chapters on applications are heavily dated.
- Sebestyn, L G, *Digital Magnetic Tape Recording for Computer Applications*, Chapman and Hall Ltd, London, 1973, an unimposing but very usable modern reference; a book shelf must for the designer types.

Commercial Literature

1. Memodyne Corp, Newton Upper Falls MA, "Recording Binary Code on the Philips Cassette," an 11 page brochure.
2. MFE Computer Access Systems, Salem NH, "Applications Notes #63 to 66" a pro and con discussion of cassette decks and recording techniques.
3. Motorola, Mesa AZ:
 - a) "M6800 Microprocessor Applications Manual," includes the complete design of a possible cassette memory system including software.
 - b) "Phase Locked Loop Manual," discussion of using PLLs for PE decoding.
 - c) "MC3467, MC3468 Applications Notes," monolithic magnetic tape read chains.
 - d) "MC4044 Applications Notes," using a PLL phase detector in PE decoding.
 - e) "MC8521 Preliminary Data Sheet," not yet released, but a complete PE decoder on a chip.
4. RCA, *COS/MOS Data Book*, "Applications Note ICAN6101, ICAN6210," PE decode/encode using CMOS.

Acknowledgements

The authors would like to thank the following individuals and groups for their gracious generosity and assistance:

Joe Roy, Motorola
Paul Nordeng and the DASL Staff, University of Wisconsin
The Economy Company.

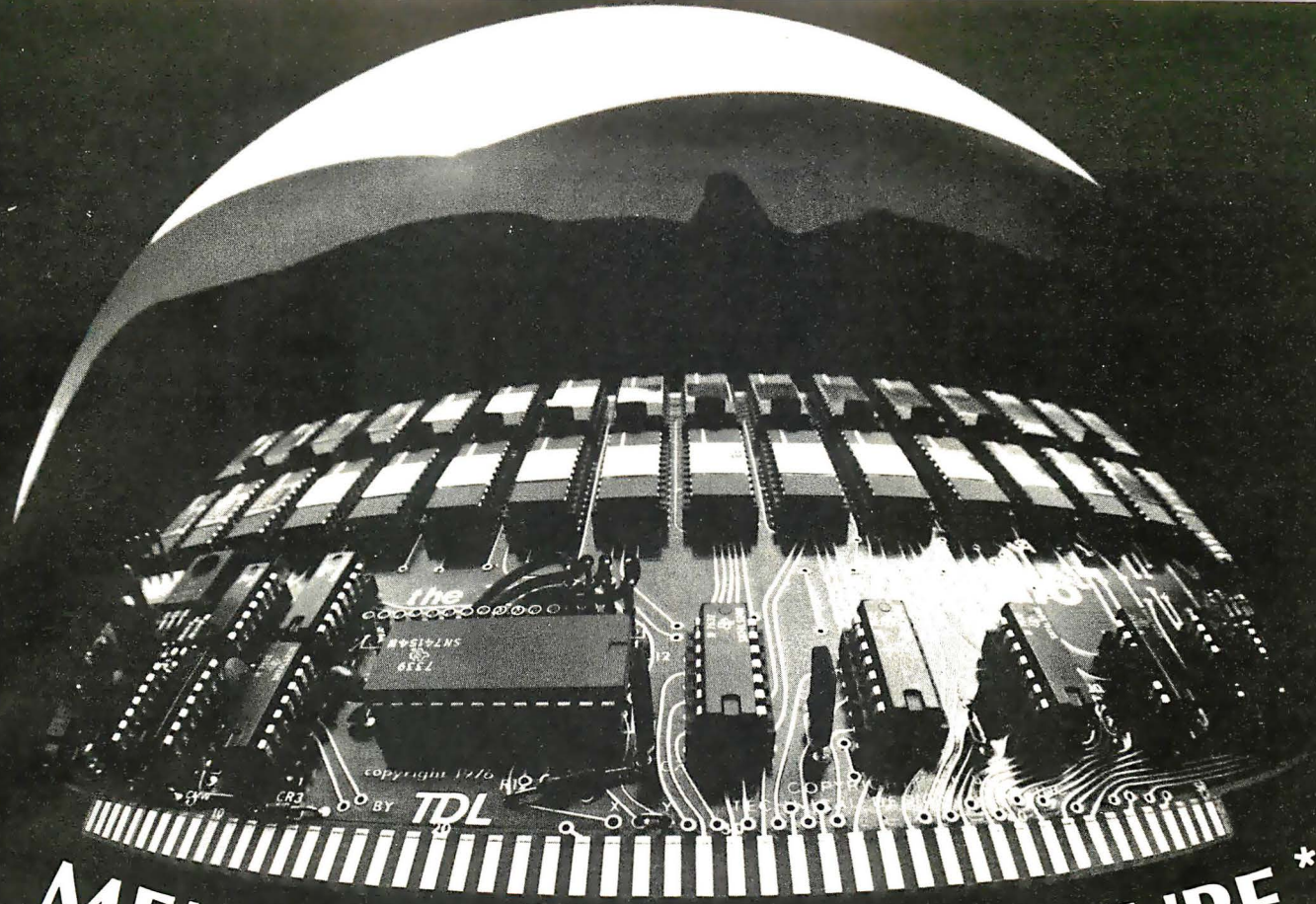

MEMORY FROM THE FUTURE*

Z16

- COMBINING:
- HIGHEST DENSITY
 - FASTEST ACCESS
 - LOWEST POWER USE
 - HIGHEST QUALITY

- GREATEST VERSATILITY
- S100 BUS COMPATIBLE
- LOWEST COST 16K STATIC MEMORY MODULE AVAILABLE

Full 16K of memory on one card available in 4K increments. Buy only what you need now. Expansion later is easy with a board you have already tested.

Utilizes the EMM SEMI 4200 memory chip which is organized as 4K by 1 bits. Provides maximum access time of only 200ns. Added to board logic time, total board access time is below 250ns. No other memory board made to S100 bus specs can match this.

Each 4K block may be individually addressed at any 4K page border. You have the versatility of most 4K boards in your 16K package. Address changes are very easily accomplished by using a simple jumper scheme. Each 4K block may be individually protected by a switch.

Power consumption is outstandingly low! Only 205ma from the +8v, 105ma from the +16v, and 24ma from the -16v, for a FULL 16K. Battery backup with a simple jack connector.

Fully solder masked and silk screened board, sockets for all IC's. Complete documentation includes source code for comprehensive memory test program and paper tape of this program.

KIT: 4K - \$169; 8K - \$295; 12K - \$435; 16K - \$574; 4K expansion kits - \$140. 16K assembled and tested: \$644. Delivery: Off the shelf to 30 days.

*** OFF THE SHELF**

**TECHNICAL
DESIGN
LABS**

The Design Leader in μ Processing

TECHNICAL DESIGN LABS, INC.
Research Park • Building H
1101 State Rd. • Princeton, N.J. 08540

Expand your memory. Hurry, use coupon below to order. Or call (609) 921-0321

Please send your Z16 MEMORY FROM THE FUTURE.

KIT: 4K - \$169 8K - \$295 12K - \$435
 16K - \$574 4K Expansion Kit - \$140 Assembled & Tested - \$644

Name Street
 City State Zip

I enclose Check Money Order - amount of \$
 Charge Card Data: BankAmericard or Master Charge. #

Exp. Date Signature

Send COD. I enclose 25% deposit. Send your FREE CATALOG.

TECHNICAL DESIGN LABS INC. • Research Park • Bldg. H • 1101 State Road • Princeton, N.J. 08540

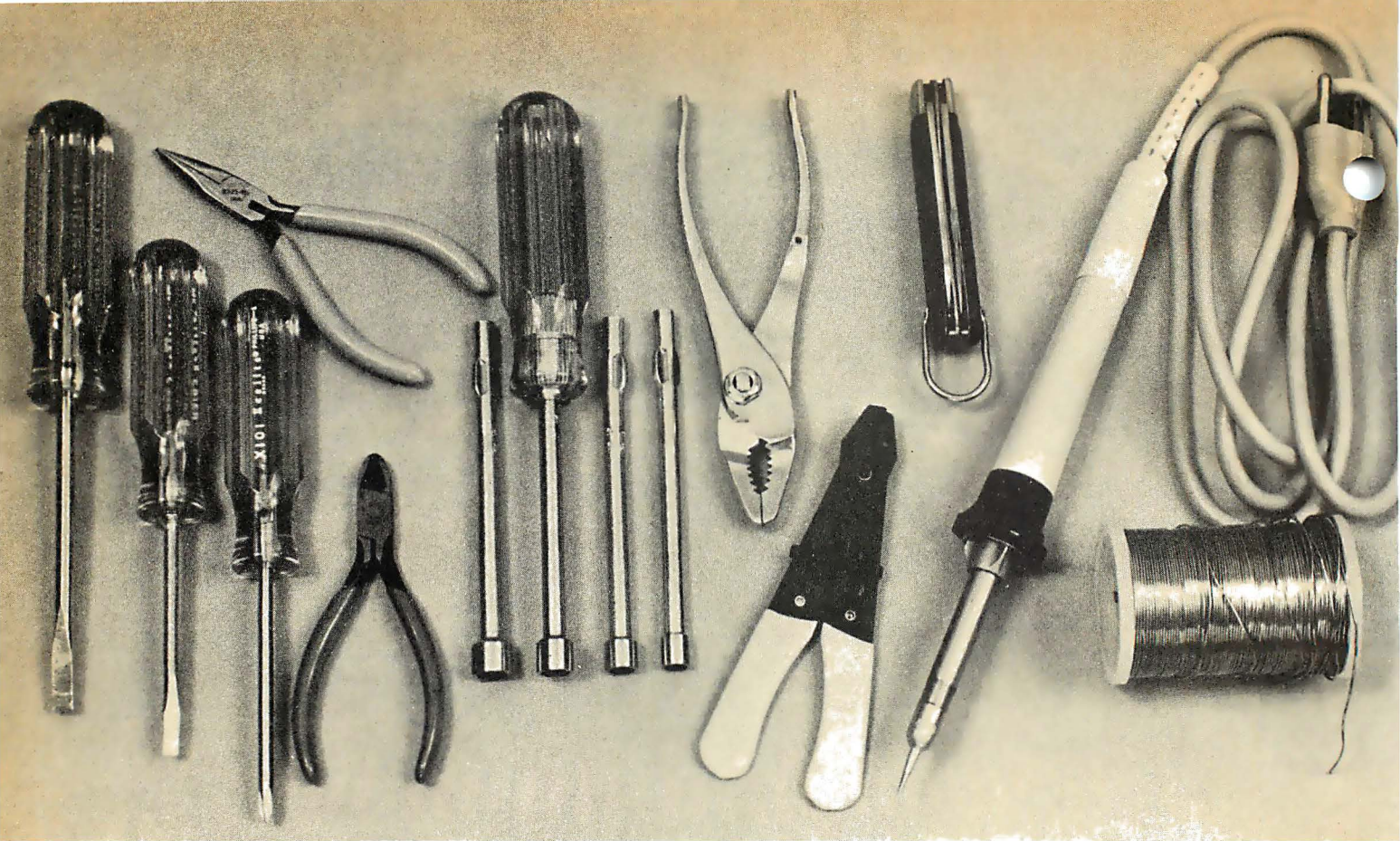

What's Involved in Kit Building?

A collection of typical tools useful in building a kit. This collection includes several sizes and types of screwdrivers, needle nose pliers, side cutter (diagonals), a set of nut drivers, pliers, wire stripper, knife, soldering iron and solder. A solder removal device, such as a bulb sucker or a mechanical action sucker, is also most useful.

Louis E Frenzel
1588 Oak Ter
St Joseph MI 49085

Most of the personal computing equipment available to the hobbyist today is in kit form. As a result, the field of personal computing as it is now known essentially centers around the building, testing and troubleshooting of computer kits. Many individuals with a "computer hobbyist" approach to the field are electronic types who enjoy kit building and consider their work with the equipment to be the main focus of their interests.

However, many other people would rather concentrate on the programming and application of the equipment. Such individuals may not enjoy or even consider themselves capable of building some of the sophisticated computer kits available. Yet

many of these nonhardware types are taking a chance on their being able to successfully learn kit building. They do so simply to be able to have the equipment that is available today. At this point in the development of the personal use computer field, being able to build a kit often means the difference between being able to own a fairly sophisticated computer or not.

There are many benefits to be gained by building a kit. Kit building is something that can be learned and easily mastered even by individuals who do not know and understand electronics. The purpose of this article is to outline the benefits of kit building and to present some basic guidelines and procedures that anyone can learn to successfully

Kit building is something that can be learned and easily mastered even by individuals who do not know and understand electronics . . .

construct a kit. The personal use computer field will continue to remain essentially a kit business for the immediate future. Why not join others in experiencing the benefits that come from this activity?

Benefits of Kit Building

Most inexpensive computer equipment is available in kit form because sometimes this is the fastest and easiest way for a manufacturer to develop and offer the product. This has allowed many small companies to enter the market quickly. Kits have been largely responsible for expediting the growth of hobby and personal computing by allowing young manufacturers to sell more products sooner.

While kits offer benefits to the manufacturer and to the builder overall, the real benefits of kit building go to the builder. Some of the benefits are obvious, but others are more subtle. Let's consider them.

Save money. One of the obvious benefits of purchasing kit equipment is the resulting savings in money. Kits almost always cost less than equivalent wired and tested products simply because the cost of labor is removed. In some cases, the price of a kit can be as low as one half the assembled price. Such savings are significant and have often made the difference between an individual being able to afford a computer or not. The cost savings has further benefited the field by allowing many more individuals to participate. It certainly makes sense to assemble the equipment yourself if you can. For a given upper limit dollar investment, you can afford significantly more equipment if you purchase kits.

Pride of accomplishment. A benefit not as obvious to those who have never built a kit is the sense of achievement that it produces. This is particularly true of large, complex and difficult kits. When an individual successfully assembles a sophisticated kit and makes it work, he or she is rewarded with a real sense of accomplishment. This is a feeling that is hard to describe, but one that becomes obvious when you build your first successful kit.

Fun and enjoyment. This is a do it yourself age. Most people enjoy doing things for themselves if they can. There is a certain amount of enjoyment in tuning your own car, growing your own garden, or paneling your basement. The same is true in the computer field. People want to do it themselves and find enjoyment in it. Kit building as a hobby fulfills this need for fun and involvement. Like other hobbies, kit building is relaxing since you become occupied in an activity that demands your full attention and skill. It takes your mind off other problems and worries.

Learning. One of the most subtle benefits of kit building is learning. Whenever you put a kit together and make it work, you automatically learn more than you realize. The whole process of kit building is educational. This is particularly true for those individuals who are not electronic experts. Beginners quickly learn basic skills such as soldering, identifying electronic components, theory of operation and basic testing and troubleshooting methods. The learning may not be obvious as you are constructing the kit, but it is there and sooner or later you will realize it.

Kits can: save money, give pride of accomplishment, provide fun, enjoyment and learning, and prepare the owner for maintenance.

Lou Frenzel has been an enthusiastic personal computing advocate of the "build it yourself" variety for some time. His personal systems presently include an IMSAI 8080 kit product with 8 K of memory, an evaluation board 6800 system from Motorola with enough additional memory to run Tom Pittman's Tiny BASIC, an ASR 33 Teletype, audio cassette interfaces, serial and parallel interfaces for custom peripherals. One projected application for the computers is to amateur radio, where he aims to use the processors for station control, and processing of message and logging data for his station, W8LJR. Professionally, Lou is Director of Computer Products for the Heath Company, a firm which started the electronics kit business as it is known today.

A "beginner's" kit assumes no knowledge of electronics and is exhaustively documented.

Preparation for maintenance. Electronic equipment is much easier to service, repair or modify if you are familiar with it. Once computer equipment has been assembled and made operable, it is generally reliable. But should service be required, it will be easier if you know and understand the equipment. Kit building gives you much of that knowledge and familiarity.

These are only a few of the most important benefits of kit building. If you want total involvement from your use of computers, you should participate in as many of the different facets of it as you can. Kit building is one of the best ways of achieving this participation.

Types of Kits

All kits are not equal. There are big kits and little kits, easy kits and complex kits. In addition, there are different types of kits depending on the approach taken by the manufacturer and the intended customer. Before you purchase a kit and attempt to assemble it, it is a good idea to be aware of the types of kits available.

There are two broad, general classifications of electronic kits, those for beginners and those for experienced hardware people. These classifications really represent the extremes of a range of types of kits; but for purposes of discussion such "ideal types" are useful. Kits designed for the beginner are generally simpler and more thoroughly documented. Even an individual who knows nothing about electronics can usually assemble such kits successfully. The assembly, test and troubleshooting instructions are thorough, take nothing for granted and lead the kit builder by the hand through a step by step process of assembly. With such a kit, most people have little or no difficulty in assembling the product and getting it to work regardless of their knowledge and experience. Even though you may not be a beginner, this type of kit is often the best in terms of value because it practically insures hassle free building and a workable end product.

Another type of kit is one designed for the experienced kit builder or electronics expert. Such kits are furnished with a minimum of documentation and assembly instructions. In some cases only a schematic diagram, a printed circuit board layout showing component placement, and a parts list are supplied. To an experienced builder, this is usually sufficient information to assemble the product and get it to work properly. Many of the computer hobby kits available today are of this type. They assume that the builder is familiar with such equip-

ment or it would not be purchased in the first place. Many novices and beginners have discovered this too late. There's nothing wrong with this type of kit because it does produce a useable end product. The problem comes when an inexperienced builder attempts to construct a kit of this kind and makes mistakes due to either lack of knowledge or experience. Such kits are highly desired by the experienced builder because they give him far greater satisfaction and a feeling of more involvement than the simpler kits, and ultimately have a lower cost since "idiot proofing" the documentation is a significant cost item in any kit. Experienced electronic kit builders receive great satisfaction from using their knowledge and experience in such projects. Many even enjoy discovering errors or having to supply missing information. They like to do the research necessary to build a product successfully. What may be a problem and big frustration to some is a real challenge and enjoyment to others.

Qualities of a Good Kit

Just what are the qualities of a good kit? It is desirable to know the elements of a good kit so that when you evaluate a product or compare competitive units, you will choose the best product for you. Here are several things you should look for in choosing a kit product.

Well designed. This is a subjective point yet an important one. A good design is one that works, has proven itself reliable and accomplishes its purpose. Other elements of good design involve the use of modern components and techniques. Good design is difficult to assess if you are not familiar with the specifics of the equipment or the latest technology. However, good product design generally shows up as a good reputation in the field, positive comments from owners, and favorable magazine test reports. If you are a newcomer, read every scrap of literature you can find, talk to people at your local computer club, and keep an open mind!

Good documentation. Just as important as good design is good documentation. This is an absolute necessity for a successful kit. The manufacturer simply must supply sufficient information to build, test and apply the product. Poor documentation usually means the difference between a good kit and a bad kit. A well designed kit can be bad because poor documentation makes it difficult if not impossible to assemble and use. Look for and insist upon good documentation to the level of detail you require.

Quality components. Quality or first grade components are a major part of any

An "experienced builder's" kit assumes some knowledge and familiarity with electronics and as a result is less expensive due to savings in documentation cost.

Some Typical Introductory Kits

The Heath Company is the oldest and largest manufacturer of kits. For those computer people who are wary of trying a complicated kit, author Frenzel suggests several of his company's products as a means of seeing what it takes to build a kit by trying out the concept on simple items. Each of these items will result in a useful accessory for the computer lab, as well as introducing the builder to the process of building kits.



a. A prototyping breadboard. In computer applications, such a breadboard can be used to temporarily try out a circuit before committing it to permanent form using wires, sockets, Vectorboard and solder or wire wrap. Power supplies at standard logic (+5 V) and typical analog (± 12 V) levels aid prototyping with this unit.



b. A laboratory bench power supply. Once built, this instrument is used to simultaneously power logic (+5 V) and provide variable metered analog levels from ± 0 to ± 20 V.

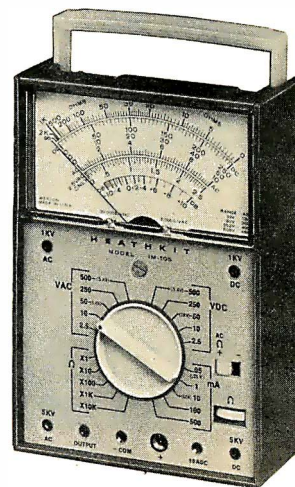

c. A multimeter. This all around useful test instrument can be built from a kit and later used to measure miscellaneous voltages, current and resistance when diagnosing or using the hardware of a computer and its interfaces.

good kit. If a manufacturer uses regular commercial grade components, then the quality is good. Quality components help insure reliability and a minimum of defects and problems in assembly. Kit suppliers can sometimes purchase surplus or degraded components at significant savings. As a result they can pass along major cost savings to you. While lower cost is certainly a significant benefit, it is often offset by the problems encountered by the poor component quality. Unless you are prepared to deal with the limitations and problems brought about by low quality components, it is best to stick with the higher priced but more reliable units using quality parts.

Designed as a kit. Many products are not designed to be kits. Such products are designed first to have specific features and to meet certain performance specifications. The fact that it is to be offered in kit form is often secondary. The designer's main purpose is to achieve a saleable and workable product. Once this has been done, many designers feel that it is only necessary to supply the components in a bag which the customer can assemble. If the product is designed as a kit, the designer is constantly reminded that the product must be easy to assemble and service. For that reason, kit design and thorough documentation is some-

what more difficult and time consuming than designing equipment that will be manufactured. Such products generally come from those manufacturers dedicated to the kit business.

Manufacturer support. A good kit manufacturer is one that supplies plenty of service and support. A customer can make wiring errors, receive a defective component or simply have difficulty in interpreting the documentation. The customer must have some way of dealing with these problems if he or she is to be satisfied with the product and complete its assembly. Always look for a kit manufacturer which has a significant amount of backup. This means the manufacturer will answer your letters and telephone calls regarding problems. In addition, the manufacturer should offer complete service and repair facilities at reasonable prices. Also check the warranty. Before you purchase a kit, be sure that you satisfy your own requirements with regard to the support and service available.

These are the main qualities of a good kit. Before spending hundreds or even thousands of dollars on computer equipment, investigate these points carefully. Your satisfaction with the products will be greater if you do.

A good design is one that works, has proven itself reliable, and accomplishes its purpose.

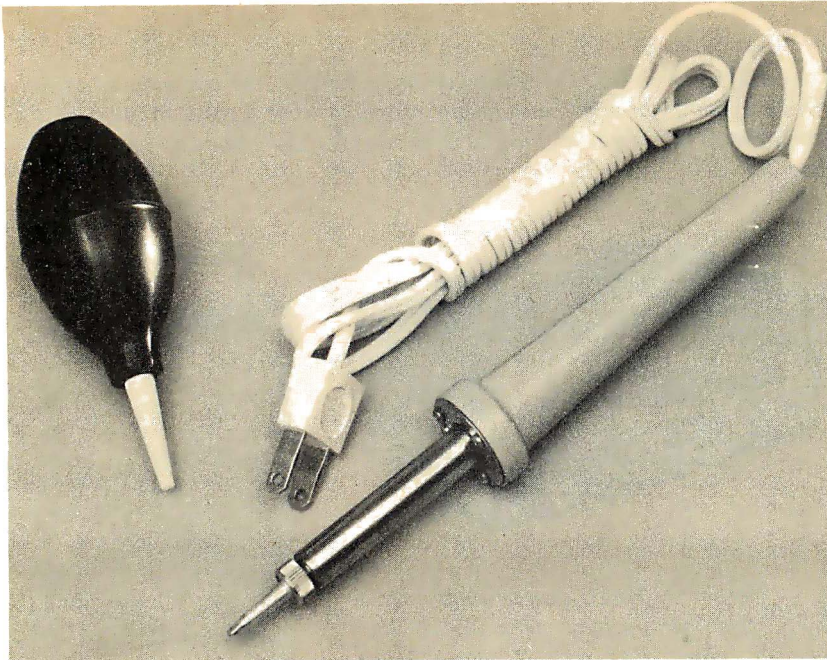

Key 1: A low wattage soldering iron is a must for building computer kits (or any kit with delicate printed circuit runs). Here is a typical low wattage iron with a small tip, along with a suction bulb device which can be used to remove solder if necessary.

Photo supplied by the Heath Company

Read test reports on the products that you are considering. Ask friends, associates and fellow club members for their opinions on the product. Often the experiences of others can help you decide. Also get as much information from the manufacturer as you can. If the data sheets and catalogs supplied are insufficient, write for further information. A reputable manufacturer will answer your specific questions and provide additional information as required.

One of the best ways to size up a product is to purchase the documentation for the kit. Most manufacturers will allow you to purchase the assembly and operation manuals. This will give you full details on the product and will give you an advanced look at the assembly instructions and other information. If you're serious about a product, this is a small investment to make to insure that you obtain a good product.

Building the Kit

Here are some tips, based on experience, that can help you build kits successfully even if you are a beginner:

Practice first. Before you wade into a \$1000 computer kit, perhaps you should test or improve your skills first on a simple, low cost kit. This is particularly true if you are a novice. If you have never assembled a kit before, start out with a small, easy to build project first. You will learn a lot by assembling this simple project first, and you will get a feel for what kit building is all about.

There are a wide variety of simple low cost kits available. Many accessories and pieces of test equipment fall into this category. Try to choose a project that will be useful to you when you get to the computer kit, or in some other way. A good example of equipment that could be of value to you when working with computers is a volt ohmmeter or a power supply. Both of these items are relatively easy to build and you will find much use for them later when working with your computer system.

Obtain the proper tools. You will need a variety of tools to build a kit successfully. There is nothing more aggravating than to come to a point in the assembly process where you do not have the tools needed. While most kits can be assembled with common tools, you should provide yourself with a minimum set prior to building your kit. It will make the kit building process go faster and easier. Here is a list of the most common tools you will need:

1. screwdrivers of several sizes: blade and Phillips types
2. needle nose pliers
3. side cutters
4. nut drivers (0.25 inch is the most useful.)
5. pliers
6. wire strippers
7. knife
8. soldering iron
9. solder
10. solder removal device

Learn to solder. The most important skill required to build a kit is soldering. The majority of computer equipment is constructed by attaching electronic components to printed circuit boards. The circuit boards are then interconnected to one another through other printed circuit boards, connectors and cables. Solder is the common bonding element in all cases. You simply must learn to solder if the kit is to work properly.

Soldering is the process of melting an alloy of tin and lead known as solder, wetting the component leads with the hot molten solder, then allowing it to cool and provide a permanent electrical interconnection. The components to be joined are brought together physically and the joint made mechanically secure. Then a soldering iron is touched to the joint so that the component leads are heated. Once the joint is hot enough, solder is applied and allowed to flow over the connection. Then the heat is removed and the solder is allowed to harden. The result is an excellent mechanical and electrical connection.

To solder properly, you must have the right equipment. Primarily this means a soldering iron and solder. For most electronic construction, a small, low wattage, hand held pencil type soldering iron should be used. One with a wattage rating of 25 to 40 watts is best. This will provide more than sufficient heat but at the same time is low enough in wattage to prevent damage to electronic components. The soldering iron should also have a small, fine tip so that solder can be successfully applied to the very small connection pads on most computer circuit boards.

The type of solder used is also important. Many kits are supplied with the proper solder. If solder is supplied, use it. If you buy your own, be sure to purchase quality electronic grade solder. The best is a 60-40 rosin core solder. The 60-40 refers to the percentages of tin and lead respectively in the solder. The rosin core means that the solder contains a cleaning element that helps to remove the oxidation from the connections when heat is applied. (Do not use acid core solder which can destroy electronic components. It will literally digest your computer.)

The size of the solder is also important. For the tiny circuit board work found in most computer products, a thin solder is best as it is easier to control the rate of flow. Solder smaller than 0.032 inches in diameter is best. This will prevent excess solder from

being applied and will reduce the possibility of making solder bridges.

Next you should develop your soldering skills. The best way to do this is to practice. The proper procedure is to first physically connect the components. Usually this involves bending the leads of the component and mounting it on a printed circuit board. The soldering iron is then used to heat the junction of the component lead and the foil on the printed circuit board. It takes only several seconds for the joint to become hot enough to melt solder. Solder is then applied to the junction and allowed to flow over the leads and copper foil. The solder and iron are removed and the connection is allowed to cool and harden.

While the procedure sounds simple, it is a bit subtle. The subtlety has to do with the amount of time you heat the junction prior to applying solder and the amount of time the iron is left on the joint after solder is removed. If you apply too much heat in the beginning you can damage the component or cause the copper foil on the printed circuit board to peel off. Yet if you do not apply enough heat, the joint will not become sufficiently hot to melt the solder properly. If the solder is not melted thoroughly it will cause a so called "cold solder" joint. These are conditions where proper bonding does not take place. The amount of time that the heat is applied is a balance between that which prevents damage and that which

Simple points: Practice first, obtain proper tools, learn how to solder, learn how to unsolder, and if all else fails, read the directions.

One of the best ways to size up a computer product is to purchase the documentation (or borrow it from a friend). This is true whether the product is in kit form or not. (A corollary is the thought that good looking and complete documentation is an excellent sales tool for the manufacturer.)

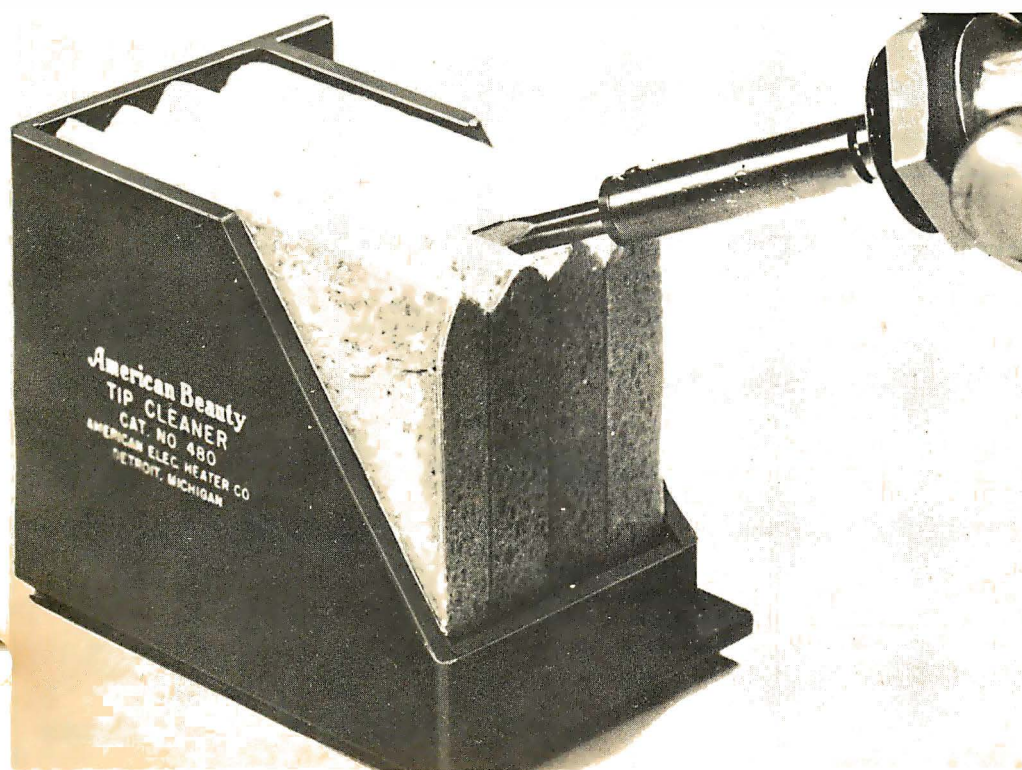

Key 2: One key to good soldering is a clean soldering tip. There are several different brands of wet sponges like this one, which can be used to clean the tip during use. Many of these products are treated with special chemicals to help improve the cleaning properties.

Photo supplied by the Heath Company

allows the solder to melt and flow as it should. The skill and timing in this operation comes only from practice.

Learn unsoldering. Another skill practically as important as soldering is unsoldering. It is often necessary to remove a component from a printed circuit board. The component may become defective and need replacing. Or you may have discovered that you connected the component incorrectly. If you learn the technique of unsoldering, the component can be removed without damaging it or the printed circuit board.

Unsoldering is best accomplished by removing the solder on the connection. Do not attempt to remove a component by simply reheating the connection and prying the component from the printed circuit board. Damage will usually result. Although it takes a little more time and care, removal of the solder first will insure that you do not

damage either the component or the printed circuit board.

Solder can be removed from the connection by first heating the connection with your soldering iron and then using a suction bulb. This is a device designed to pull the solder from the connection by a vacuum created in a rubber bulb. A plunger type device known as a solder sucker can also be used.

It may take several applications of the tool to remove all of the solder. Get as much off the connection as you can. Then use a knife or needle nose pliers to carefully break the component lead loose.

Another method of removing solder from a connection is to use a wire braid coated with rosin. The braided wire is coarse and

Key 3: Use proper soldering technique. This set of illustrations provided from the Heath Company documentation of kits illustrates proper soldering technique when assembling circuit boards. As noted at the bottom, it is important to heat both the component lead and the printed circuit board contact. If either is missed, then a bad joint as at B or C could result.

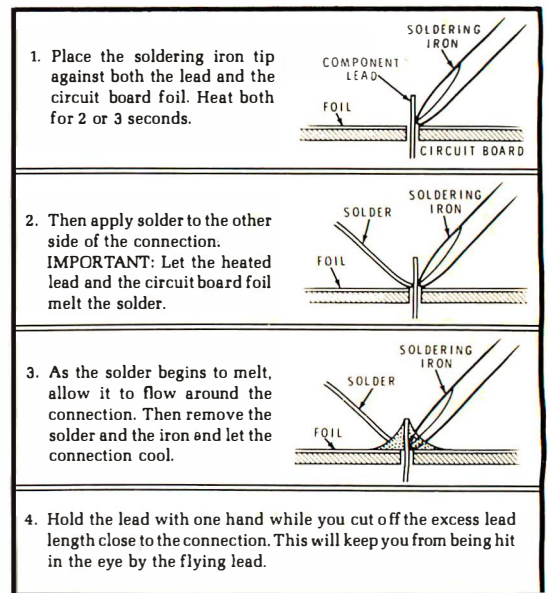

Be sure the solder made a good electrical connection. When both the lead and the circuit board foil are heated at the same time, the solder will flow onto the lead and the foil evenly. See Illustration A. The solder will then make a good electrical connection between the lead and the foil.

When the lead is not heated sufficiently, the solder will not flow onto the lead as shown at B. Reheat the connection and, if necessary, apply a small amount of additional solder to obtain a good connection as shown at A.

When the foil is not heated sufficiently, the solder will blob on the circuit board as shown at C. Reheat the connection and, if necessary, apply a small amount of additional solder to obtain a good connection as shown at A.

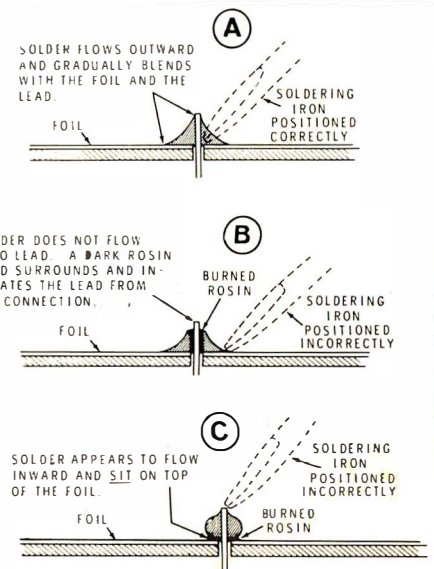

can soak up a lot of solder. The rosin cleans the braid and the connection and encourages the capillary action that literally slurps the solder off the connection. To use the braid you simply place it on the connection and heat it with the soldering iron. The solder will flow up into the braid leaving the connection clean and open. Again, several applications may be necessary to remove all of the solder. Solder removal braid is available at most stores selling soldering irons and related equipment. It is extremely effective and will save you much time and possibly some expensive components and printed circuit boards.

Follow directions. It seems almost ridiculous to point this out, but one of the most common faults of kit builders is not following the assembly instructions. The assembly instructions have usually been tested to insure that they work. If you use a different assembly sequence or fail to note some of the special instructions, you are most likely to make a mistake. Even though you may be

an experienced kit builder, sometimes there are subtleties in the assembly process that make it absolutely essential that you follow the given directions.

Another precaution is to look for any errata sheets or correction notices *before* you begin the assembly. Some errata sheets are included randomly or at the end of the supplied documentation. Don't take chances; catch the errors in the documentation first to avoid mistakes.

Don't ruin your investment by assuming that you can do it by yourself. Protect your investment and follow the instructions. Remember the old saying, "If all else fails, read the instruction manual," is true.

Take your time. When building a kit, take your time. The faster you go the more likely you are to make a mistake. Most people who purchase kits are anxious to put them together and use them. This is only human and certainly understandable. But unless you have patience and take your time to follow the instructions and do quality work, your

Use of sockets remains a highly recommended practice — but use quality sockets by all means.

Key 4: If you make a mistake, fix it. To remove solder, use a bulb sucker (see key 1), a mechanical solder sucker tool (a), or a solder removal braid (b).

(a) Photo supplied by the Heath Company

(b) Photo courtesy of Wik-It

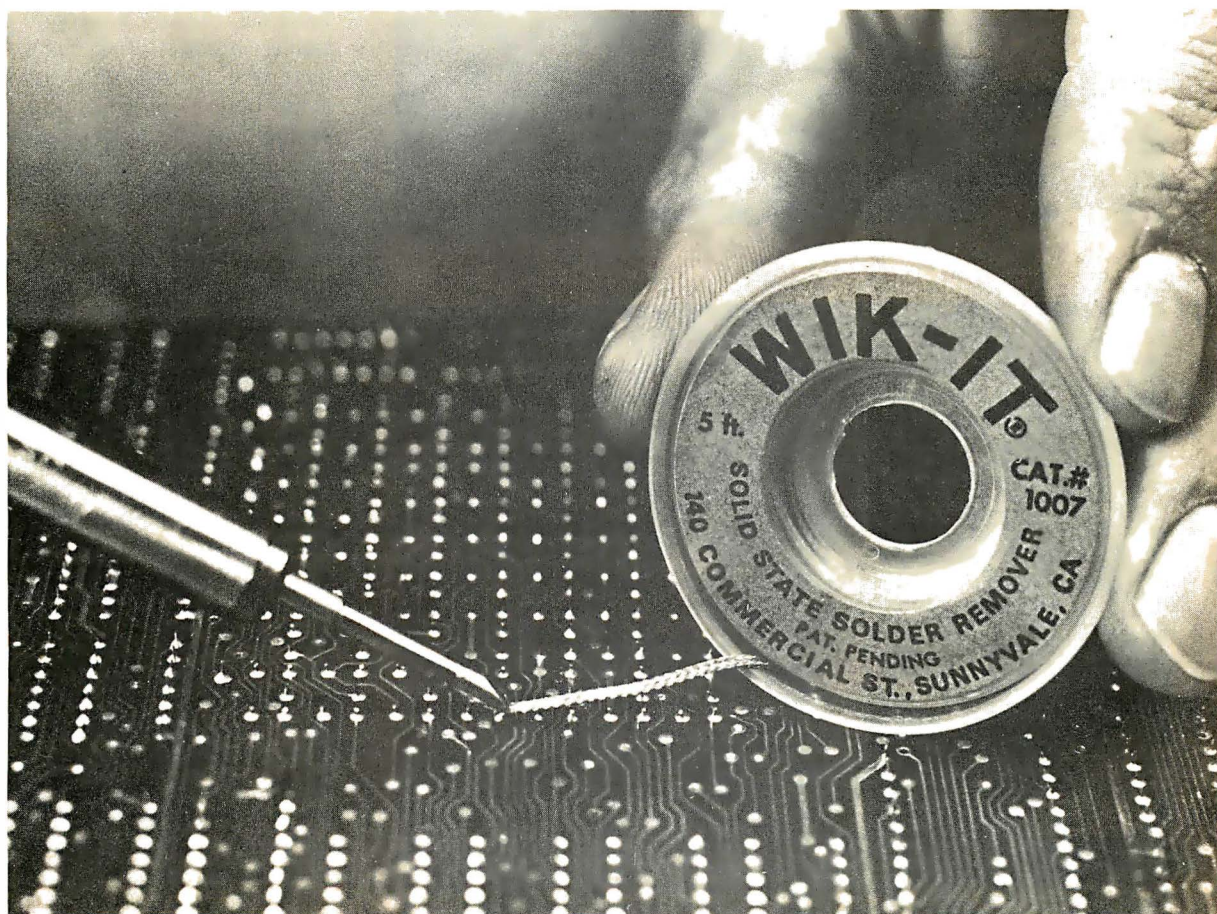

Key 5: A detailed solder braid removal sequence, supplied by Wik-It. (a) Find the connection to be desoldered. (b) Heat the connection through the braid, causing capillary action to suck up the solder. (c) Remove soldering iron and braid, to view the desoldered connection.

(a)

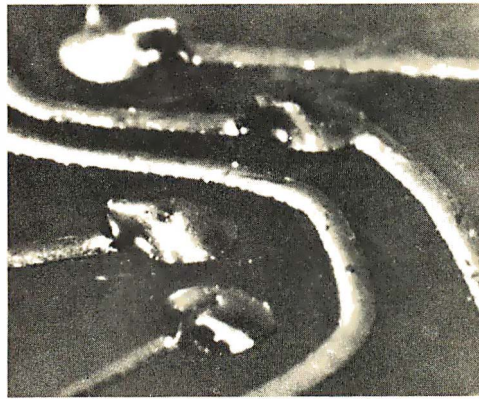

(b)

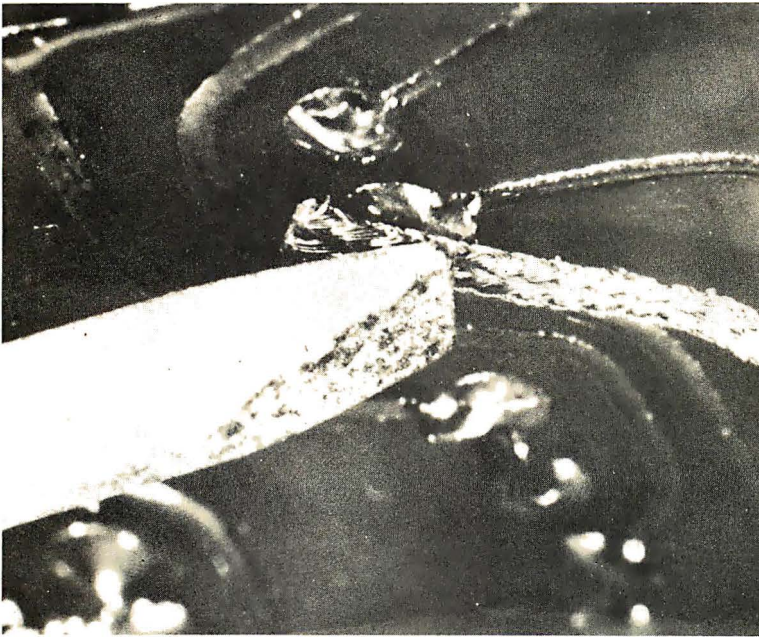

(c)

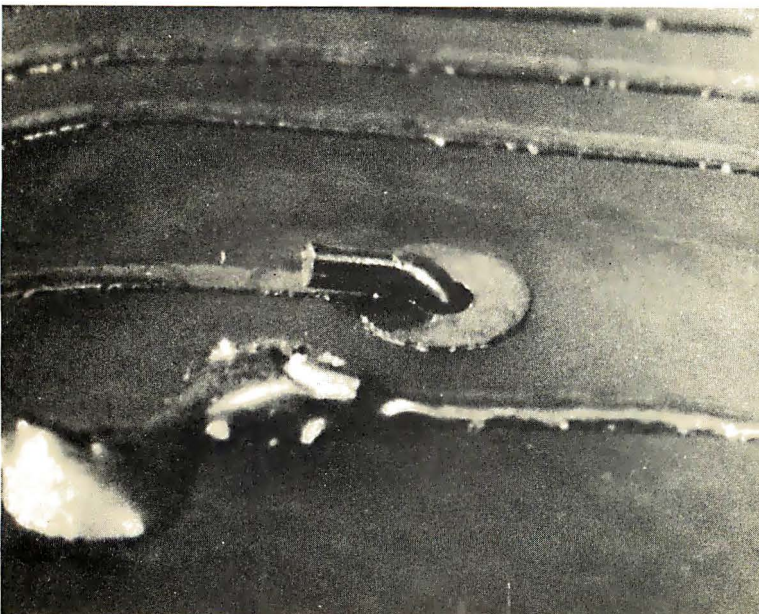

chance of achieving a successful build are much lower. A better end product will result if you take care and time.

Part of the concept of taking your time is to spread the kit building process out over a long period. It is a lot better to have eight one hour or four two hour kit building sessions than it is to have a single eight hour session. The longer the kit building session, the more mistakes you are likely to make. When you find yourself getting tired, losing interest, or attempting to short cut the instructions, stop. Go back to building when you have had a chance to rest.

While it's good to take your time in building a kit, just keep in mind that most kits come with a limited time warranty. Thirty and ninety day warranties are typical, so it is highly desirable that you assemble the kit in less than that time. If you discover any defective parts or other problems, you can get them replaced within the warranty period. Take your time, but don't lose the benefit of any warranty that you may receive.

Ask questions. As you're building a kit you may have questions about the assembly. If the instructions are not clear or problems arise, don't guess. Don't take anything for granted. Attempt to answer the question yourself, of course. Study the directions more carefully. Ask a friend who has built a similar product. Call or write the manufacturer to be sure of what you're supposed to do before you go on. You can save a lot of time, money, grief and dissatisfaction if you get answers to questions before going ahead with what may be an incorrect decision.

Use sockets. Many electronic kits do not supply sockets for the various components. Transistors, diodes and integrated circuits are usually soldered directly to the printed circuit board. Some of the more expensive and delicate components may use sockets. While sockets may not be supplied, it is generally a good idea to add them yourself. The sockets will allow you to remove components for troubleshooting purposes or to replace them if they become defective. The socket will add a little extra cost to your kit, but the advantages are worth it. The ease with which a product can be serviced when all of the integrated circuits are in sockets is excellent. It is one investment that you may question in the beginning but will certainly find worthwhile later should you have difficulty. If you choose to use sockets, however, be sure to use high quality *new* sockets, preferably with gold or other nontarnishing finish on the contacts.

Provide yourself with reference resources.

Many manufacturers supply all the information needed to construct the kit successfully. Additional information simply is not necessary. But there are some kits that require you to have additional information. For example, it may be necessary for you to know the pinouts or theory of operation of the various TTL or MOS integrated circuits used in the kit. Because of this, it is a good idea to provide yourself with a reference library of books, catalogs, data sheets and any other information you can get your hands on. You will also find general textbooks and application notes from the integrated circuit manufacturers to be helpful. When you run into trouble or have questions, your references can provide the answers. It is an excellent investment that you should make at the time that you purchase your kit.

Two of the most important references you should have are the *Texas Instruments TTL Data Book* or its equivalent and the catalog or data sheets from the manufacturer of the microprocessor used. Adam Osborne's series of microprocessor books are particularly good and will also make excellent background reference sources.

Be careful with components. Most electronic components are small and delicate. They can be easily damaged physically and most can certainly be destroyed by excessive heat. Diodes, polarized capacitors and most integrated circuits can be put in backwards which would cause improper operation and possible electrical damage. Integrated circuit pins can also be bent and broken off very easily. Be very careful with every component as you install or solder it.

Another important precaution concerns the installation of MOS integrated circuits. These devices can be destroyed by static electricity. A static charge can be transferred to a MOS device by your hand or the soldering iron. Most MOS devices are supplied mounted in protective foam to keep the pins shorted. Leave the devices in this foam until you are ready to install them. When you do, be sure you ground yourself or remove any static charge before you pick up the device. If you use sockets, the MOS damage from static charges can be greatly reduced. Any charge from the soldering iron will be dissipated in mounting the sockets, not installing the integrated circuits. Further, when installing the integrated circuit in the socket, you can short all the leads together by pressing the board and socket against conductive foam.

All of the above recommendations and precautions are obvious for the most part. It's easy to read them and agree with them,

Provide yourself with a library of reference information about computers, integrated circuit logic data, etc. It will prove to be one of the most valuable pieces of "equipment" in your personal computing endeavors.

but if you are to assemble your kit successfully, you absolutely must follow them. It's a small price to pay for protecting your investment.

What to Do If You Have Trouble

Whenever you purchase a kit you should prepare yourself for the fact that you may make a wiring mistake or encounter a defective component. If you plan for this in the beginning you will not be surprised if it happens. In most cases you will find that it is not a serious problem. Instead it is simply an inconvenience to overcome. If you approach it with the right attitude, you will not be dissatisfied with your kit. Here are some tips on what to do if you experience difficulty.

When you finish building the kit, follow the test, checkout and troubleshooting instructions given by the manufacturer. The quality of this information varies from one manufacturer to another. Some supply no information while others furnish detailed troubleshooting charts. Use whatever information is available to you first before going on with the recommendations given below.

Question the problem. The first thing to ask yourself: Is the trouble you experienced really a problem? It may indeed be, but it may also be that you are using the equipment improperly. The controls may have been set incorrectly or you may be wrongly interpreting the results. The solution to this is to read the instruction manual carefully to be sure that you are doing things properly. In computers, as in flying, cockpit problems or pilot errors are a typical source of trouble. The hardware may be good, but the operator may be defective. Even in simple kits this is a very common problem. Due to the complexity of computers, no kit will be totally immune from this problem.

Check your assembly. Once you have eliminated operator error as the trouble, you can assume that you have a hardware problem. The first suspect is assembly errors. Go back and double check your assembly. This is time consuming but it can often turn up the problem. A good way to do it is to have a friend help you. Often by working with someone else you can find the problem

that you may have overlooked yourself. A common mistake is poor solder connections. It may be difficult to spot one bad solder connection among thousands, and even a bad solder joint sometimes looks good. As a result, the first step should be to resolder each and every connection in the kit. Again this is tedious but will often solve the problem. To do this, simply touch the soldering iron to each solder connection briefly to remelt the solder. If you see a wisp of smoke come out of the connection, it may indicate that the rosin in the joint was not sufficiently melted thereby causing a poor connection. The joint may have been a cold solder joint where no electrical continuity existed at all. Simply reheating the connection made it good.

As you are resoldering the connections, look for solder bridges. This is a thin trace of solder that is accidentally drawn between adjacent pads on the circuit board. The solder bridge causes a short. These bridges are usually eliminated as each solder connection is reheated. But they may not be. As you are resoldering each connection, look carefully at adjacent pins to be sure that shorts do not exist. Some solder bridges are so fine that they are difficult to find. Use a magnifying glass and strong light to help. As you go through a complete circuit board you may discover connections that you forgot to solder or components that did not get installed properly. Simply resoldering all the connections is an excellent way to recheck your assembly since it methodically covers all points.

Once you have double checked your soldering and assembly, again test the equipment. Many times the problem will be solved and proper operation will result. If the difficulty still exists, the problem may be a defective component. Unless you have had specific experience in troubleshooting electronic and digital equipment, locating a defective component can be difficult. For that reason, it is best to call for help.

Seek help. The first step is to ask a friend or the manufacturer for help. You may be able to find a friend who has built a similar piece of equipment or who has experience in troubleshooting. Don't hesitate to call or write the manufacturer for help. It is the manufacturer's responsibility to help you get the kit working properly.

Another alternative is to seek help from your local computer store. Most store owners will be familiar with common problems and may have just the advice, information or help you need.

Before you ask for help, however, it is best to isolate the problem yourself if you

can. Write down all of the symptoms. Make some tests yourself to try to determine what is happening or not happening. If the processor runs at all, run some simple diagnostic programs to attempt to isolate the problem. Try to obtain as much information as possible before you ask for help. The more information that you supply the better the quality of the help that you will receive. For example, one of the things that you can do is measure the power supply voltages. Often the equipment is not working simply because it is not receiving power. Use a voltmeter to check power supply voltage at each of the printed circuit boards in the equipment. If an oscilloscope is available, check for the presence of clock pulses.

Once you have accumulated as much information as possible, write a letter or make a phone call to the manufacturer. Continue this process until the trouble is located. If all else fails, return the kit to the manufacturer or your local computer store for repair. Above all, don't give up. The real fun begins when you get your computer running.

Kit Versus Wired Products: Your Decision

Kit building is fun, challenging and satisfying. It is educational, and you can save a lot of money. Most people who have built kits successfully highly recommend it. Yet some computer hobbyists simply do not want to spend the time or become involved with kit building. They want to concentrate on programming and applications. It is probably best that these individuals buy wired and tested units. Although this reduces the number of products available, it does eliminate the potential problems associated with kit building. It also eliminates the benefits.

Before you decide to buy a wired product, you should also consider having a friend or other individual build the kit for you. Often you can locate someone who is willing to build a kit for a price far lower than you would pay for an assembled unit from the manufacturer. I have heard of several examples where individuals have assembled kits for others simply to be able to have the experience of building and using the kit themselves for a period of time. There are a number of small companies who are in business to build kits for individuals. The prices are usually less than the assembled and tested units available from the manufacturer.

Even though you may have shied away from building a kit, try it. You may find that it is easier and more fun than you suspected. ■

Be sure to remember the motto of a certain very large computer company: **THINK.** The application of computers as general purpose problem solvers requires thought on the part of the user, whether the computer is a kit or a traditional high priced product. The only computers which have any hope of being totally "idiot proof" are those which have had the thought requirements distilled into a well designed application program in products such as a hand calculator, a microwave oven controller, a "turn key" application system or any situation where the programming is supplied in a packaged solution to a problem.



Guess who just bought our new Microfloppy[™] for \$1095 including software?

Plug-compatible for \$1095

iCOM's brand new Microfloppy[™] is specifically designed for the personal computer user. It's smaller, using the new 5¼-inch diskette, and is priced at only \$1095 including disk drive, power supply, cabinet, controller/interface card, all cables and connectors, plus, on diskette, iCOM's new FDOS-M software, including assembler, editor, and file manager. And for a limited time*, you also get an 8K Disk BASIC package at no extra cost.

Best of all, iCOM's Microfloppy[™] is fully assembled and tested. It's 100% compatible with Altair, IMSAI, Poly 88 and other microcomputers using the Altair bus format.

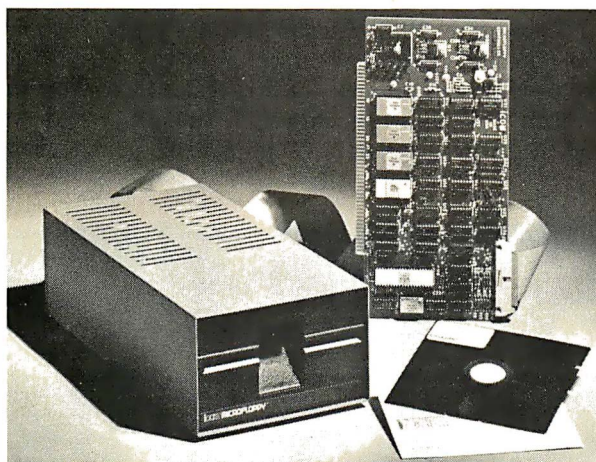

Much faster than a cassette

This compact, economical Floppy Disk System is 10 to 15 times faster than a cassette. Programs can be loaded in seconds, a source program of several thousand characters can be corrected and a new file stored on diskette in less than a minute. Any of up to 175 files can be reached in 1.5 seconds.

iCOM — the leader

We've been building Floppy Disk Systems for microcomputers for nearly three years. Thousands of our systems are operating perfectly in the field. Many major computer manufacturers have incorporated our Floppy Disks into their systems. We deliver, and we'll be around to give you service whenever you may need it. You see, we're a division of Pertec Computer Corp., one of the largest and most respected manufact-

urers of peripherals, microsystems, data entry products, and data processing systems.

So you don't need to risk getting burned by a fly-by-night company. Order an iCOM[®] Microfloppy[™] and be sure of getting the best.

See iCOM's Microfloppy[™] now at your local computer store. Or contact us for the name of your dealer.

*Offer good through April 15, 1977

iocom[®] MICROPERIPHERALS[®]

a division of Pertec Computer Corporation

6741 Variel Ave., Canoga Park, CA 91303 U.S.A.
(213) 348-1391 TWX 910-494-2788

Articles Policy

BYTE is continually seeking quality manuscripts written by individuals who are applying personal systems, or who have knowledge which will prove useful to our readers. Manuscripts should have double spaced typewritten texts with wide margins. Numbering sequences should be maintained separately for figures, tables, photos and listings. Figures and tables should be provided on separate sheets of paper. Photos of technical subjects should be taken with uniform lighting, sharp focus and should be supplied in the form of clear glossy black and white or color prints (if you do not have access to quality photography, items to be photographed can be shipped to us in many cases). Computer listings should be supplied using the darkest ribbons possible on new (not recycled) blank white computer forms or bond paper. Where possible, we would like authors to supply a short statement about their background and experience.

Articles which are accepted are typically acknowledged with a binder check 4 to 8 weeks after receipt. Honorariums for articles are based upon the technical quality and suitability for BYTE's readership and are typically \$25 to \$50 per typeset magazine page. We recommend that authors record their name and address information redundantly on materials submitted, and that a return envelope with postage be supplied in the event the article is not accepted. ■

perhaps the extreme case for shipment of BYTE magazines to foreign subscribers. Not satisfied with waiting three months or so for the very current information we put out in BYTE each month, he started immediately to search for alternatives.

His first urge was to import BYTEs in sufficient quantity to sell to his neighbors in the Sydney area, thereby assuring (so the theory went) that he got them on a timely basis by way of a bulk shipment. With that in mind, he figured that he'd send them air freight to his shop, then distribute them. Nice theory, but, in bulk it cost US \$1.50 or more to ship each magazine by air -- so his bulk shipments ended up going on the same boats which carry the surface mail. (It costs nearly US \$6 to send just one copy by air mail!) So much for that theory. After taking a bulk shipment of BYTE each month for several months, John hit upon another solution to the problem: Maybe he could talk BYTE into printing locally for distribution in Australia. Shortly after that brainstorm struck, we got our first long distance phone call from John Bannister.

Phone calls from Australia are most interesting. You'd expect that a certain decay in quality would occur as the distance increases. But much to our surprise, the phone conversations with John, whether by cable, radio or satellite, often came through with a quality perhaps half an order of magnitude better than a simple transcontinental conversation with an advertiser in California! Of

course, for such calls, either one party or the other is bound to be half asleep, for the time differential is 11 hours between EST and the time zone which encompasses Sydney. At any rate, the first phone call was to explore the possibility of setting up a new Australian publishing house with John as the principal, whose purpose would be to print an Australian English language version of BYTE. Thus began a series of long distance negotiations, proposals, Telex messages and phone calls concerning the arrangements. Now that all the negotiating and arrangements have been crystalized into a signed contract, we can announce what has transpired.

Beginning with the January 1977 issue of BYTE magazine, two new editions will be published for readers in the more technologically sophisticated areas of Southeast Asia. One edition, in English, will be printed and distributed to subscribers in Australia, New Zealand, Singapore, Hong Kong, the Philippines and other countries where readers of English are interested. A second Asian edition will be translated into Japanese and distributed in Japan. The editorial content of both new editions will be identical (English edition) or identical semantically if different in detail (Japanese edition). For the first issues, the advertising copy will also be identical; but John's office in Sydney and his agent in Tokyo will solicit local advertising for these editions, while preserving the option for our US advertisers to reach these foreign markets.

Technologically, the arrangement is fairly



A BYTE family portrait, circa December 1976. Clockwise from top left are Manfred Peschke, Virginia Peschke, John Bannister and Carl Helmers. (Note: the reader probably suspects that all those impressive looking books in the background are the world's greatest collection of computer tomes. While they do indeed look impressive, they'd really only impress a farmer since they contain the genealogical records and trivia of the Guernsey cow breed.)

Subsystem "B" makes the computer you already have work almost as well as a new Sol-20.

Add it now, and for a limited time we'll throw in a new module with 512 bytes of preprogrammed PROM and 1024 bytes of RAM memory free!

Processor Technology's Subsystem "B" puts together the major system elements you need to get your Altair or IMSAI up and running.

You get both RAM and PROM memory, parallel, serial, cassette and video display interfaces, and software. Software includes a 512 byte bootstrap loader program so you can load any Processor Technology CUTS ("Byte/Kansas City") 1200 BAUD cassette tapes. Standardized subroutines in ROM, similar to those in a Sol personality module, are used by many Processor Technology software packages to improve program efficiency. You'll find you rarely need to touch your front panel switches. With our Subsystem "B" you are up and running as soon as you turn on the power.

Three subsystems are available, depending on your memory requirements. Each Subsystem "B" includes five S-100 bus compatible modules as listed below. Each is dependent upon our new GPM module (GPM = General Purpose Memory) which provides 1024 bytes of low power static RAM and 512 bytes of preprogrammed EPROM as well as space for up to 8192 bytes more of ROM or 2708 type EPROM. The GPM module accepts the new ROM version of our well known ALS-8 Editor/Assembler software package.

With Subsystem "B" you have guaranteed compatibility with all Processor Technology software and hardware products.

Subsystem Model	B55	B95	B175
Total memory provided (bytes)	5632	9728	17920
Display I/O	VDM-1	VDM-1	VDM-1
Parallel, Serial I/O	3P+S	3P+S	3P+S
Tape Cassette I/O	CUTS	CUTS	CUTS
Memory	4KRA	8KRA	16KRA
Price	\$594	\$730	\$964

NOTE: The GPM module with both RAM and PROM is included FREE in all the above subsystems. The GPM kit is \$129 if purchased separately.

The ALS-8/ROM chip set is \$159. SIM-1 & TXT-2/ROM add-on set is \$60 and requires both GPM and ALS-8/ROM.

I want Subsystem "B" to get my Altair or IMSAI up and running.

- Enclosed is a check for \$_____. I want:
 California residents add sales tax. No shipping charge. B55 at \$594
- Mastercharge # _____ B95 at \$730
 (include Interbank No. and expiration date) B175 at \$964
- Send more information

Name _____

Address _____

City _____ State _____ Zip _____



6200 Hollis Street, Box B
 Emeryville, CA 94608 (415) 652-8080

John Bannister (left) and Carl Helmers discussing the problems of translating BYTE into Japanese, while perusing the Japanese edition of Scientific American, December 1976. It turns out that translators do some interesting things. For example, in the translated version of an article by an author with a name of, for example, "Lane," the initials stay in Roman characters, but the surname — since it has a generic equivalent in Japanese script — is translated. But if the surname has no immediately identifiable generic root or equivalent, it remains in English spelling as do technical terms with no direct equivalent.



simple. At the time we give the final OK to the negatives from which BYTE is printed each month, our printer, The George Banta Company of Menasha WI, will make duplicate copies of all the negatives, and send them to Sydney where John will modify the book to fit the local edition. Eventually this will include local advertising, local club and newsletter information, and possibly putting in new product information and related items of interest to local readers. The bulk of the material in the magazine will, however, remain identical to the US edition.

All our Australian, Japanese and Asian subscribers will be given the option of converting their subscriptions to the local edition which, due to its simultaneous publication, will be up to date as opposed to three months behind due to shipping delay.

Once it became apparent that we would be able to get together on this venture, John made the trip from Sydney to Peterborough NH via Lost Angeles. I call it Lost Angeles because the airline on which he was traveling managed to lose his luggage in the transfer. Arriving at Logan Airport, Boston (after neglecting to tell anybody what flight he was coming on), he was met by Debra "Sherlock" Boudricau of BYTE, who in a feat of deductive reasoning and investigation, managed to pinpoint the flight and John Bannister, using only his one statement, "I'll be there at 8:30 tomorrow morning." As recounted later, it was a simple deduction: There was only one transcontinental flight

out of Los Angeles which arrived at Logan at 8:30 AM, and an Australian newly arrived is easy to spot: After an elapsed travel time of 22 hours with essentially no sleep, watch for the only person who is walking in a daze.

After initial greetings on arrival in Peterborough, John sacked out for about 15 hours, after which we began an intensive series of conferences on the details of publishing remotely, how to arrange shipment of the negatives, timing the monthly operation, etc. After a busy two days, I picked up John at midnight on December 1, and we spent the wee hours at my home and laboratory discussing things and comparing notes on the problems of computer enthusiasts in our respective countries. After I dropped him off back at the motel around 4 AM, we all showed up at the BYTE offices and took the pictures accompanying this editorial. Then, with the contract signed, Virginia and Manfred Peschke and John went to New York (by way of Boston) for a visit to *Scientific American* (see box) and some of the fabled surplus outlets which are reputed to still exist in that city. Manfred and Virginia finally saw John off to Australia from New York and returned to Peterborough that weekend.

One of the details of the Australian arrangement is a surprise and delight to Deborah Luhrs, who has been with BYTE nearly from the beginning. In order to assure a bit of experience, as far as handling subscriber orders and managing an office is

IF YOU'RE STILL PLAYING GAMES IT'S BECAUSE YOU HAVEN'T SEEN OUR SOFTWARE LIBRARY

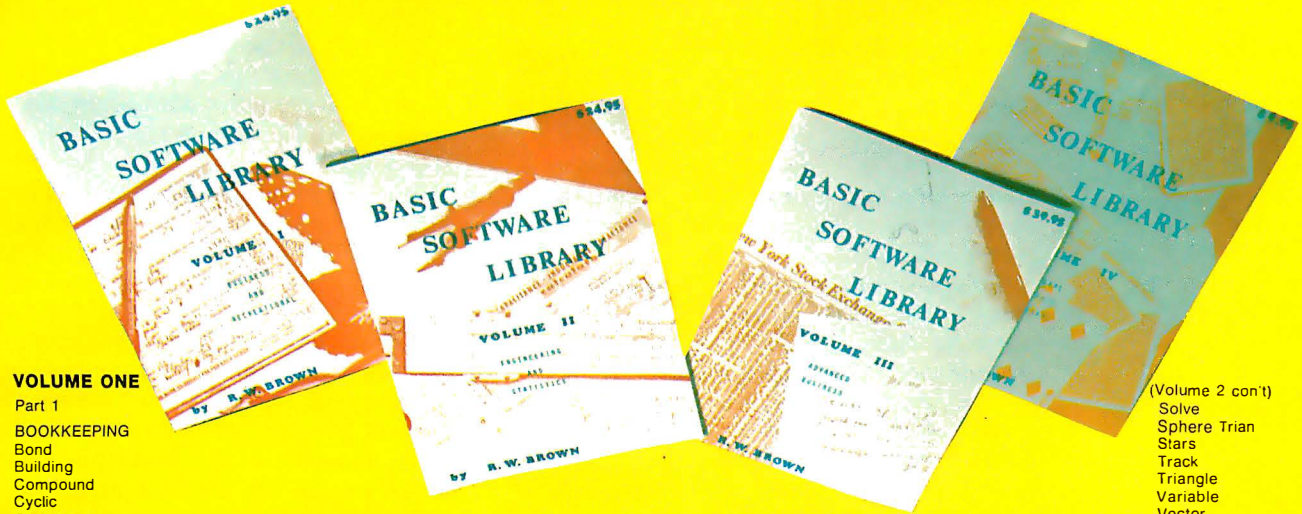

VOLUME ONE

- Part 1
- BOOKKEEPING
- Bond
- Building
- Compound
- Cyclic
- Decision 1
- Decision 2
- Depreciation
- Efficient
- Flow
- Installment
- Interest
- Investments
- Mortgage
- Optimize
- Order
- Pert Tree
- Rate
- Return1
- Return 2
- Schedule 1
- Part 2
- GAMES
- Animals Four
- Astronaut
- Bagel
- Bio Cycle
- Cannons
- Checkers
- Craps
- Dogfight
- Golf
- Judy
- Line Up
- Pony
- Roulette
- Sky Diver
- Tank
- Teach Me
- PICTURES
- A. Newman
- J.F.K.
- Linus
- Ms. Santa
- Nixon
- Noel Noel
- Nude
- Peace
- Policeman
- Santa's Sleigh
- Snoopy
- Virgin

VOLUME TWO

- Part 3
- MATH & ENGINEERING
- Beam
- Conv.
- Filter
- Fit
- Integration 1
- Integration 2
- Intensity
- Loia
- Macro
- Max. Min.
- Navaid
- Optical
- Planet
- PSD
- Rand 1
- Rand 2

This **BASIC SOFTWARE LIBRARY** is a complete do it yourself kit. Written in everybody's **BASIC** immediately executable in **ANY** computer with at least 4K, no other peripherals needed. Over 1000 pages of source codes, descriptions and instructions.

**** Also available at most computer stores ****

This library is the most comprehensive work done of its kind to date. There are other software books on the market today but they are dedicated to computer games. The intention of this work is to allow the average individual the capability to easily perform useful and productive tasks with a computer. All of the programs contained within this Library have been thoroughly tested and executed on several systems. Included with each program is a description of the program, a list of potential users, instructions for execution and possible limitations that may arise when running it on various systems. Listed in the limitations section is the amount of memory that is required to store and execute the program in K Bytes.

Your Library is Waiting

The much requested Volumes III & IV are ready. If you already have Volumes I and II you'll want to add these to your set. With the addition of Volume IV there is no reason why anyone who even *THINKS* of using a computer can't own their own **SOFTWARE LIBRARY**. You can start yours for less than \$10 plus postage and handling. These programs are **IMMEDIATELY** executable in **ANY** computer with at least 4K. The entire Library is 1000 pages long, chocked Full of Program source code, instructions, conversions, memory requirements, examples and much more. **ALL** are written in compatible **BASIC** executable in 4K MITS, SPHERE, IMS, SWTPC, PDP, etc. BASIC compilers available for 8080 & 6800 under \$10 elsewhere.

VOLUME I & II — \$24.95 each
 VOLUME III — \$39.95 each
 VOLUME IV — \$ 9.95 each

add \$1.50 per volume for postage and handling. 10% discounts on purchases of any three (3) volumes.

Volume discounts are available to qualified users & dealers.

Personal checks — allow 4 weeks for shipping. Pricing subject to change without notice. If air mail shipping desired add \$3 per volume to price, Continental U.S. only. Foreign orders add \$8 for each volume.

(Volume 2 con't)

- Solve
- Sphere Trian
- Stars
- Track
- Triangle
- Variable
- Vector
- Part 4
- PLOTTING & STAT
- Binomial
- Chi-Sq.
- Coef
- Confidence 1
- Confidence 2
- Correlations
- Curve
- Differences
- Dual Plot
- Exp Distri
- Least Squares
- Paired
- Plot
- Plotpts
- Polynomial Fit
- Regression
- Stat 1
- Stat 2
- T-Distribution
- Unpaired
- Variance 1
- Variance 2
- XY

APPENDIX A BASIC STATEMENT DEF

VOLUME THREE

- Part 5
- ADVANCED BUSINESS
- Billing
- Inventory
- Payroll
- Risk
- Schedule 2
- Shipping
- Stocks
- Switch

VOLUME FOUR

- GENERAL PURPOSE PROGRAMS
- Bingo
- Bonds
- Bull
- Enterprise
- Football
- Funds 1
- Funds 2
- Go-Moku
- Jack
- Life
- Loans
- Mazes
- Poker
- Popul
- Profits
- Qubic
- Rates
- Retire
- Savings
- SBA
- Tic-Tac-Toe



SCIENTIFIC RESEARCH

1712-B FARMINGTON COURT
CROFTON, MD 21114



PHONES ORDERS CALL
(800) 638-9194

INFORMATION and MARYLAND RESIDENTS
CALL (301) 721-1148



A Note of Thanks to *Scientific American*

We at BYTE wish to thank David Trussell of Scientific American for taking time out of a busy schedule to meet with Virginia and Manfred Peschke and John Bannister of BYTE to discuss some of the problems and pitfalls of publishing foreign language editions of magazines. With the Japanese language edition of BYTE we begin our first such version in translation, and it proved quite helpful to us to have a bit of informal and friendly advice from people experienced in that endeavor.

*We also learned that Scientific American, which is printed on extremely high quality paper, has lately been having trouble procuring supplies. The paper is necessary to achieve good reproduction of the color images which are so characteristic of their product. Who could possibly be eating up all the good quality paper? It turns out that there is a hot competition between Scientific American, *Oui* and *Penthouse* to see who can buy all the special paper. This quality magazine is being skinned alive!*

concerned, John thought it a good idea to take up a suggestion which Virginia made: that Debbie should travel to Australia for a few months to help set up the office of the new firm, BYTE Publications [Austr/Japan] Pty Ltd. Although Debbie left today (December 6 1976) as this editorial is being written, she still doesn't quite believe that it's all really happening!

Who is John Bannister, our new "Affiliate Publisher — Southeast Asian Editions"? John is a man of considerable experience in the Australian electronics industry, in the Sydney area. He became interested in small scale data processing systems following Don Lancaster's original TV typewriter articles in *Radio Electronics* and the later articles by Jonathan Titus and company on the Mark-8 processor in that same publication. His assistant in business operations (book-keeping and moral support department) is his wife Pamela, and he's well aware of the possibilities for using personal computers in the education of his two preschool age children. He's convinced (as are we) that it is just a matter of time until the revolution of personal computing we've seen in this country finally reaches his own country and Japan — to say nothing of the other technologically oriented countries of the world. ■

WHO NEEDS IT?

Biphase cassette recorder interface, digital comparator, no adjustments, switch-selectable speeds. Altair, IMSAI, Tarbell compatible. Manual \$2.50 Kit \$120.00. Assembled \$160.00.

NEW

Universal cassette interface with independent latched input port for keyboard or other use, interrupt capabilities, switch-selectable baud rates, 800 to over 10,000 baud, digital comparator, level and sync indicators, status ports, extra IC pads for recorder relay. User selectable sync character. Altair, IMSAI, Tarbell, Kansas City. Manual \$3.50 Kit \$135.00. Assembled \$180.00. C.O.D. \$1.50.

DAJEN Electronics
7214 Springleaf Ct.
Citrus Heights, CA 95610
(916) 723-1050

Z-80 COMPUTER

SYSTEM with RAM/PROM Module
Cabinet & Expansion P/C Backplane
Controls and Power Supplies Manuals
- I/O Options, Kit

\$395.

ALTAIR/IMSAI/POLY/SOL Compatible Modules

Z-80 Processor Board	\$150.
8080/6800 CPU Board	130.
8080A CPU & RAM/PROM	210.

Memory Modules	
4/8/16/32K RAM from	100.
2/4/8/16K PROM from	90.
I-O/Communications mod.	95.
Video Display Module	180.
3M Cartridge & Interface	290.
Floppy Disc & Interface	690.
DEC LSI-11/4K Module	800.

COMPUTER SYSTEMS

(313) 779-8700
26401 Harper Ave.
St. Clair Shores, Mich. 48081

WHEN YOU NEED

SOLDER

DUNTON'S



**SPECIFY: NOKORODE
"P.C." SOLDER**

LET OUR REPUTATION GIVE YOU THAT
**EXTRA MARGIN OF
SAFETY.**

AT FINE ELECTRONICS STORES EVERYWHERE.

MFG. BY:
M. W. DUNTON COMPANY
350 KINGSLEY AVE. — BOX 6205
PROVIDENCE, R. I. 02940
401 — 331-3600



MORE MERLIN MAGIC!!!

Now . . . the already tremendous value of MERLIN, the best, most versatile video interface, is an even greater value with the introduction of two inexpensive **add-on** features.



SUPER DENSE GRAPHICS \$39.00 320H X 200V RESOLUTION

MERLIN's Super Dense Graphics is an add-on board which mounts directly to the MERLIN Video Interface. Each of 64,000 graphic dots is **individually** controllable and located **on-screen**. The kit includes a manual with X-Y coordinate transformation software listing.

SOFTWARE CASSETTE I/O \$29.00 1500 BAUD

MERLIN's Software **1500 Baud** Cassette I/O is an external add-on to the MERLIN Video Interface. It connects, along with a keyboard, to the MERLIN KYBD and I/O Port through a 16 conductor flat cable. The kit includes a manual with a listing of all necessary software, also available as part of the MEI ROM.



For more information, fast, write us direct.

Pricing:			
MERLIN Assm.	\$349.00	MERLIN Manual	\$ 10.00
MBI ROM/RAM	\$ 39.95	MERLIN Kit	\$269.00
Super Dense Add-on	\$ 39.00	MEI ROM	\$ 34.95
		Cassette I/O Add-on	\$ 29.00

Master Charge and BankAmericard accepted.



MiniTerm Associates, inc.

Box 268, Bedford, Mass. 01730 (617) 648-1200



THE FIRST WEST COAST COMPUTER FAIRE

A Conference & Exposition
on
Personal & Home Computers

San Francisco Bay Area - Where It All Started - Has Its First Home Computing Convention

7,000 to 10,000 People

100 Conference Presentations

200 Commercial & Homebrew Exhibits

Two Banquets with Outstanding Speakers

Special-Interest Social Centers

Publication of *Proceedings* Being Planned

In Northern California's Largest Convention Facility, San Francisco's Civic Auditorium

CONFERENCE SECTIONS ON HOME COMPUTING

Being Planned

- Computer Graphics on Home Computers
- Computer-Driven & Computer-Assisted Music Systems
- Speech Synthesis Using Home Computers
- Computers & Amateur Radio
- Computer Games: Alphanumeric & Graphic
- Personal Computers for the Physically Handicapped
- Computers & Systems for Small Businesses
- Tutorials for Hardware Novices & Software Novices
- Software Design for Personal Computers
- Microprogrammable Microprocessors for Hobbyists
- Optical Scanning for Inexpensive Program & Data Input
- Floppy Disc Systems for Home Computers
- Hardware & Software Standards for Personal Systems
- Seminars for Club Leaders, Editors, Organizers, etc.
- Personal Computers in Education (associated with a University of California short-course)

-- AND MUCH MORE --

PRESENT-WORLD & FUTURE-WORLD BANQUET SPEAKERS

Banquets to be Held in San Francisco's St. Francis Hotel

Fascinating Speakers will Discuss the Past, Present, & Future

- Frederik Pohl, Science Fiction Writer;
Lecturer to NASA, American Astronautical Society, New York Academy of Sciences, World Future Society, etc.
Robots You Can Make for Fun & Profit
- John Whitney, Pioneer Computer Film Maker,
Computer graphics experimenter under grants from NEA, Guggenheim Foundation, & IBM
Digital Pyrotechnics: The Computer in Visual Arts
- Henry Tropp, Mathematician, and Principal Investigator for History of Computers Project jointly sponsored by the Smithsonian Institution & AFIPS
The 1940's: The FIRST Personal Computing Era
- Ted Nelson, Author & Fantast, Director of the Xanadu Electronic Literary Network, Lecturer at Swarthmore College
Those Unforgettable Next Two Years

april 15-17, 1977 · san francisco

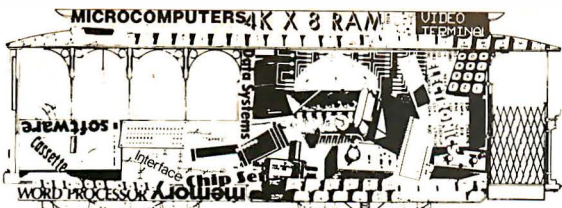

THE FIRST WEST COAST COMPUTER FAIRE
A Conference & Exposition on Personal & Home Computers

FIND OUT ALL THE DETAILS -

GET YOUR FREE COPY OF THE SILICON GULCH GAZETTE

- Details of the programs & speakers
- Information about the banquets' arrangements
- Accommodations information, & registration forms for the St Francis Hotel (Faire Headquarters Hotel), & the other three Computer Faire hotels
- Pre-registration details for the Faire (reduced admission for those who pre-register)
- Details of the *Proceedings* expected to be published
- Articles about the homebrew exhibits
- Weather information, & tourist trivia regarding San Francisco
- Listings of the commercial exhibitors
- *AND*, just to make it interesting:
 - "Hot news", & raging rumors from "Silicon Valley" (the San Francisco Bay Area)
 - Product announcements, equipment descriptions, hardware & software news, etc.

CO-SPONSORS INCLUDE AMATEUR, PROFESSIONAL, & EDUCATIONAL GROUPS

- The two largest amateur computer groups: Homebrew Computer Club, Southern California Computer Society (SCCS)
- Both Bay Area Chapters of the Association for Computing Machinery (ACM) San Francisco Peninsula Chapter, Golden Gate Chapter
- IEEE Computer Society's Santa Clara Valley Chapter
- California Mathematics Council
- Stanford University's Electrical Engineering Dept.
- University of California's Lawrence Hall of Science
- People's Computer Company (PCC)
- Community Computer Center
- Bay Area Microcomputer Users Group (BAMUG)
- Professional & Technical Consultants Assn (PATCA)
- Amateur Research Center

april 15-17, 1977 · san francisco

Cut out, or photocopy; then fold, and tape in position.

- Send a free copy of *Silicon Gulch Gazette*.
- Send program & accommodations information, & Pre-registration Form (those who pre-register may take advantage of a reduced admission fee).
- Send speakers' instructions.
- Send homebrew exhibitors' instructions.
- Send commercial exhibitors' prospectus.
- Send details on the expected Computer Faire *Proceedings*.

PLEASE PRINT OR TYPE

NAME _____

ADDRESS _____

CITY _____ STATE _____ ZIP _____

77-1-12b

by COMPUTER FAIRE + (415) 851-7664

FIRST CLASS
 Permit No. 91
 Palo Alto, CA

BUSINESS REPLY MAIL
 No Postage Necessary If Mailed In U.S.A.

POSTAGE WILL BE PAID BY

THE FIRST WEST COAST COMPUTER FAIRE

BOX 1579
 PALO ALTO CA 94302

Simplified Omega

Ralph W Burhans
Research Engineer and Lecturer
Ohio University
Electrical Engineering Dept
Athens OH 45701

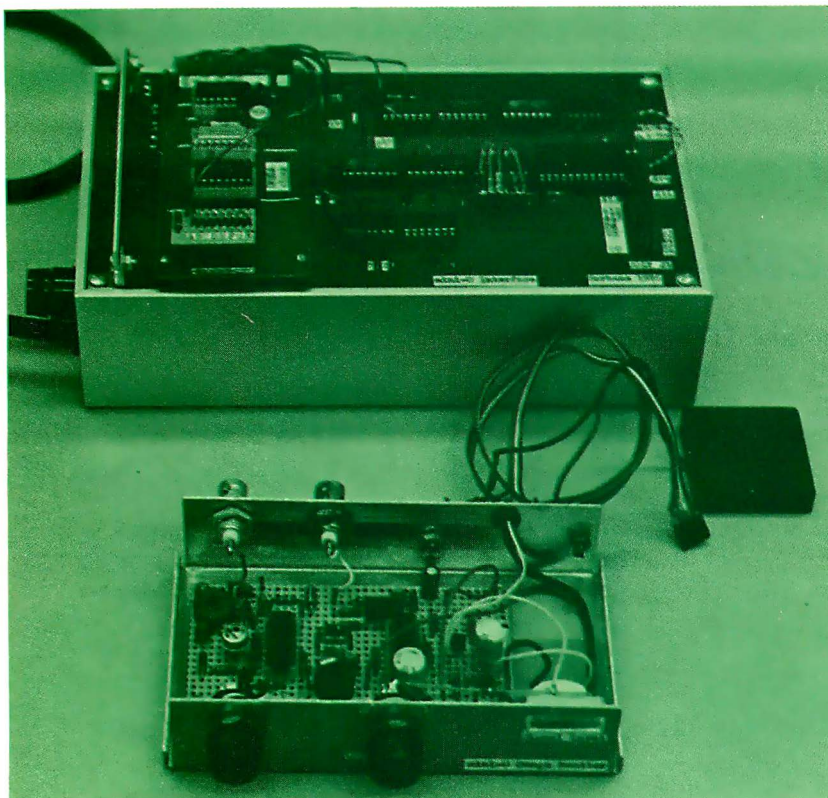

Photo 1: Mini-O microcomputer interface, with the radio frequency front end. The RF front end (in the foreground) is essentially a receiver for 10 kHz radio signals broadcast by Omega transmitters widely spaced around our planet. The device was built in prototype form using perforated board and sockets, as seen here. The microcomputer interface (to a JOLT system) is via the mounted plug at the right of the interface box (rear unit in photograph).

Antennas

The receiver is designed to use an E-field short whip or wire antenna of random length. This type of antenna is often called an "E-field" antenna because it responds to the electric field component of the radio signal. A 20 cm wire will do in many cases if the antenna is mounted in the clear. A 10 meter length wire works well in cases where there is not a lot of local 60 Hz harmonic interference. Unfortunately, the Omega System's 10.2 kHz is exactly the 170th harmonic of 60 Hz and urban laboratory monitors sometimes have problems with bursts of 60 Hz interference from high power SCR-TRIAC controls or rotating electrical machinery. The boat owner or aviation buff usually doesn't have problems with AC line interference and a short whip mounted vertically will often suffice for the antenna.

Preamplifier

The preamplifier of figure 1 is constructed in a small weatherproof box with a tight feedthrough insulator or fitting right at the antenna and a coaxial cable lead-in for the signal back to the receiver (see photo 1). The coax supplies both power to the preamp and a preamplified Omega signal back to the front end module. The circuit is not critical but should be adjusted for a broadband peak at about 10.2 kHz by minor changes in the 0.02 μF capacitor across the inductor. Tapping down on the 600 ohm line output transformer improves the Q of this simple bandpass filter circuit.

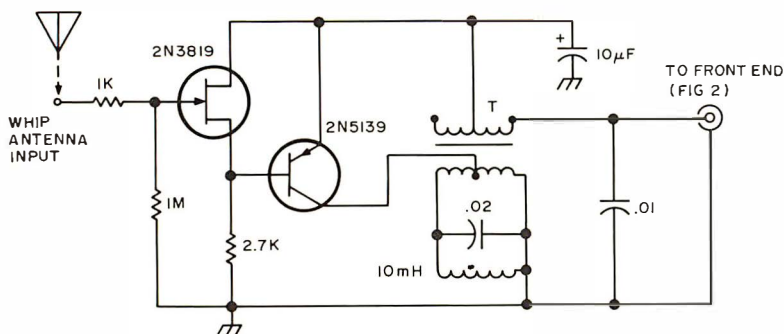

Figure 1: Mini-O antenna preamplifier, 10.2 kHz. This preamplifier is shown as constructed in one version in photo 4. The 2N5139 transistor must be selected for a high β . Power for this preamp is sent up the coaxial cable from the front end unit, thus sharing the same wire with the signal. The transformer, T, is a 600 ohm center tapped to 600 ohm center tapped line to line transformer, a Mouser 80TM016 or 80TM009 part number in electronics catalogs. The Q factor for this amplifier is 2, with a gain of 20 dB at 10.2 kHz.

Receiver Details

ping down on the 600 ohm line output transformer improves the Q of this simple bandpass filter circuit.

The preamplifier has an input impedance of 1 megohm with a 1 k ohm series resistor as a current limiter for gross interference such as from nearby lightning discharges. We have yet to burn out a 2N3819 JFET in these front ends but have had trouble with similar MOSFET input transistors in earlier preamplifier systems. Other JFETs like the MPF102 will work just as well.

The 2N5139 PNP transistor provides a gain of 20 dB or so in this circuit and the transistor should be selected for a high beta, greater than 100 if possible. The Q of this circuit is about 2 which supplies some desirable reduction of low frequency and high frequency interference in the very first stages of the receiver.

Front End

The heart of the radio frequency analog circuitry involves a multistage bandpass filter with two active filters and two passive mechanical filters, as in figure 2. The signal from the preamplifier drives the first Seiko SM-31R mechanical filter directly from the

Omega Navigation is a method of determining where your boat or plane is currently located, anywhere on the globe. It is a "free" method of navigation to a certain extent, since it is sent out by the cooperating nations via radio transmissions for shipping and defense traffic, but is available to any technological hitchhiker willing and able to build the proper interface. (Free in this instance is defined to mean the accounting for each person's share of the tax cost is so diffuse it can't be traced.)

In this month's installment, Ralph W Burhans continues the Omega information with the description of the detailed function and circuitry of an Omega navigation receiver which can play with any microprocessor system possessing an 8 bit input port. [The Mini-O Omega receiver design is intended for an experienced amateur electronics person, and to the best of our knowledge is not yet available in kit form for the novice.] How do you use it once it's built? The details of the software will have to wait until the third and final part of this series, by Richard J Salter, which will appear in the next BYTE.

680 ohm isolating resistor which supplies power to the preamplifier. This first stage of mechanical passive filtering is followed by an active tunable bandpass filter to help reduce sideband responses and increase the system gain. A 1 k ohm pot at the output of this first active filter is used as a radio frequency gain control. The next stage is quite similar.

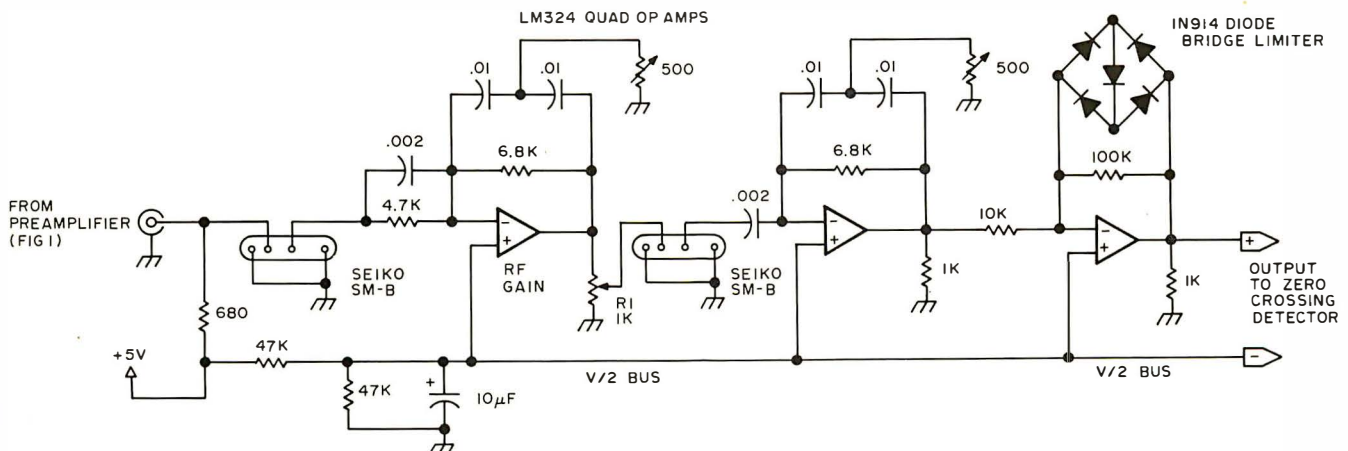

Figure 2: Mini-O mechanical filter front end amplifiers. This active circuit uses two mechanical filters manufactured by Seiko to provide a narrow bandwidth of 14 Hz at the -3 dB points and a gain of 40 to 60 dB. The output passes through a diode bridge limiter implemented with an operational amplifier section, prior to reaching the zero crossing detector of figure 3. The physical construction of this circuit is shown in photo 3.



Photo 2: Mini-O in operation on the bench. The setup shown here uses a Teletype Model 33 ASR with the JOLT computer (at right in front of power supply), and the Sinclair clock reference (in front of interface box on bench). The display on the oscilloscope shows output from a lines of position digital to analog conversion output described (in concept) in part 1 of this article.

We have found that it is usually necessary to provide the 1 k load resistors to ground at the output of each of the operational amplifier stages as shown, to help reduce regeneration problems [ie: oscillations neither planned or desired] which depend on the particular parts layout on the circuit board.

The overall system gain and frequency response can be altered by changing the 6.8 k ohm feedback resistors across the first two op amps to 15 k ohms or so. However, too much gain here results in instability. The overall gain of this filter and limiter circuit is about 40 dB as shown. The bandwidth is about 14 Hz at the -3 dB points and the skirt selectivity is excellent, about -80 dB down at the next Omega channel frequency of 11.33 kHz!

Several other types of front end bandpass filter arrangements have been used with Vernitron ceramic filters and with Statek quartz tuning fork filters. However, these are more difficult to fabricate and adjust properly or involve more expensive circuitry compared to that required for the Seiko SM-31R mechanical filters.

Alignment of the filter of figure 2 is quite simple. A stable function generator with a sine wave output at 10.200 kHz is fed to the input terminal through an isolating capacitor

and attenuator. The output from the limiter stage is observed on an oscilloscope and tuned for a peak amplitude by adjusting both 500 ohm trimmer resistors on the bandpass stages. It might be desirable to check the impedance matching by altering the $0.002 \mu\text{F}$ input capacitors from each SM-31R filter. These serve to "tune" the filter peak to about 10.200 kHz but are rather broad. A capacitance between 0.002 and 0.003 mF is usually required and a fixed ceramic type capacitor is adequate or perhaps two parallel ceramic capacitors to adjust each filter peak to 10.200 kHz (such as 0.002 in parallel with 0.0005). In tuning the filter circuit be sure to attenuate the signal generator to a low level so that the limiter is not clipping the peaks at the output. The operation of the limiter can be checked by increasing the drive to the filter to the point where the output starts to look like a square wave with rounded-off corners. The limiter peak-to-peak threshold is about 1 V using 1N914 diodes. Other types of limiter circuits using the MC1357 or LM2111 IC chips have also been used but the simple diode bridge circuit of figure 2 is adequate for most Omega users. If you happen to have a dual channel oscilloscope, the phase shift versus signal amplitude may

The Seiko filters are available from:

Seiko Instruments Inc
2990 W Lomita Blvd
Torrance CA 90505
Phone (213) 530-3400

Seiko also has filters for the 11.333 and 13.600 kHz Omega channels; write for information. The original SM-B filter has now been changed to type SM-31R.

Order a SM-31R 10.200 kHz 2 piece kit: unit cost \$8.50 X 2 pcs = \$17, postage and handling charge = \$1.50 [6% sales tax for California Residents only].

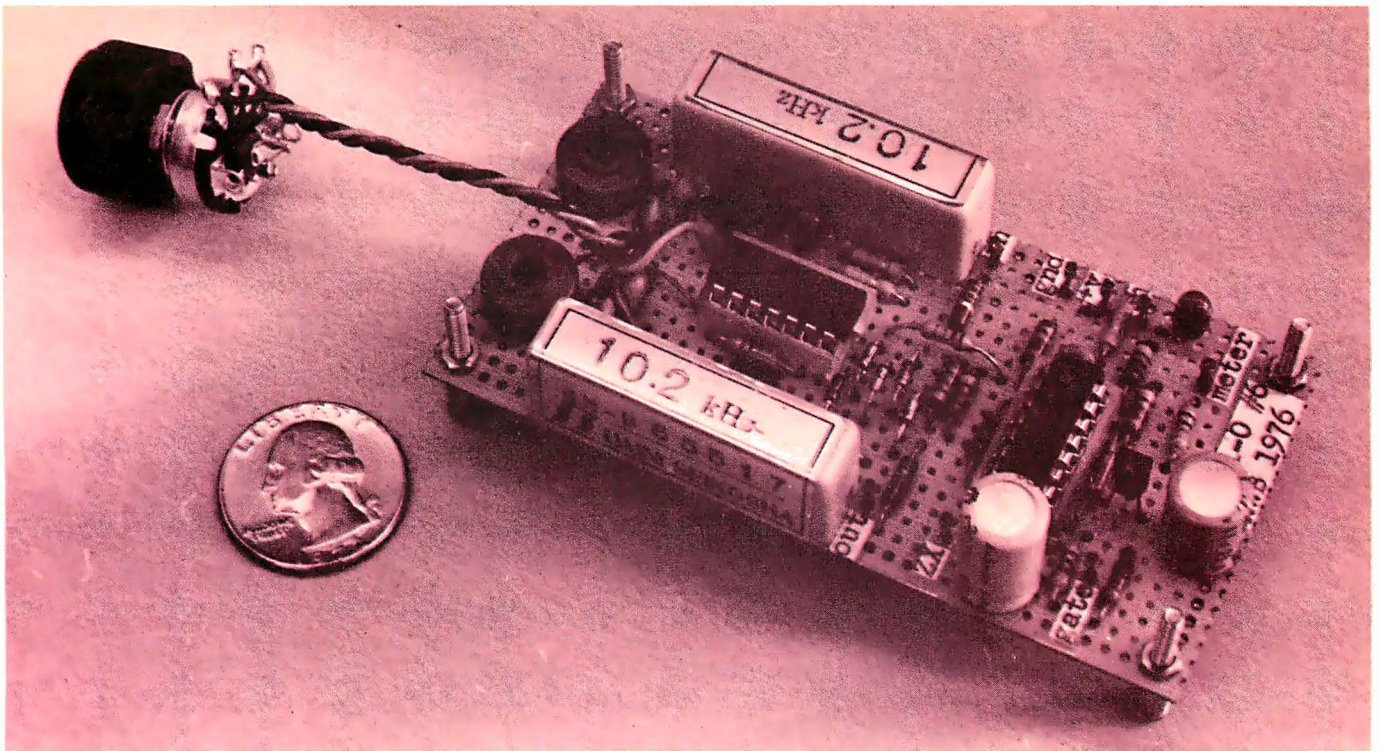

Photo 3: Mechanical filter front end board. This picture details the construction of the mechanical filter front end for the Mini-O receiver, described by the circuit diagram of figure 2. The potentiometer hanging loose at the left is the 1 k RF gain potentiometer, R1 in figure 2. The board shown here also includes the zero crossing detector of figure 3, at the right.

be checked by observing the input signal on one channel and using this to synchronize the scope sweep while observing the filter output on the other channel. There should be very little shift of the phase as the signal level is increased up to the point of limiting. At the limiter threshold only a slight phase shift should be observed. If a large change in the phase when limiting is observed, it usually means the circuit layout is poor and some kind of regeneration is taking place, or undesirable feedback; extra bypassing of the V/2 power bus with a tantalum low inductance capacitor of 10 μ F might help, or reduce the overall circuit gain by changing the active filter feedback resistors to a lower value.

Zero Crossing Comparator and Envelope Gate Generator

The output of the limiter of figure 2 drives the comparator circuit of figure 3. The 10.2 kHz zero crossings are obtained from one section of a quad LM339 comparator integrated circuit. This circuit is designed with a small amount of hysteresis and is intended to be centered on the V/2 output level of the limiter stage output DC level. LM339s are not perfect and usually have a slight offset so that it is desirable to trim the exact operating point by summing a

very small correction from a resistor returned to the positive power supply of +5 V. A value of 500 k ohms to 2 megohms is usually sufficient with 750 k shown in the

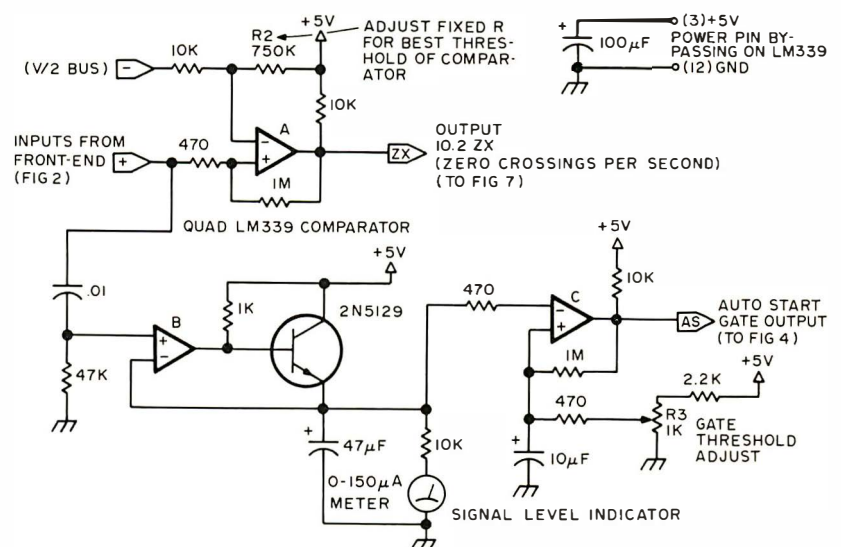

Figure 3: Zero crossing detector. This circuit shows the LM339 comparator sections used to determine zero crossing transitions (A), monitor the current signal level (B) and generate the automatic starting gate output (C) based on current signal level. The zero crossings output threshold is set by resistor R2, which must be selected to give the best threshold response. The auto start output is an "envelope gate": It is high when the signal is above the threshold set by R3, and low when below that threshold.

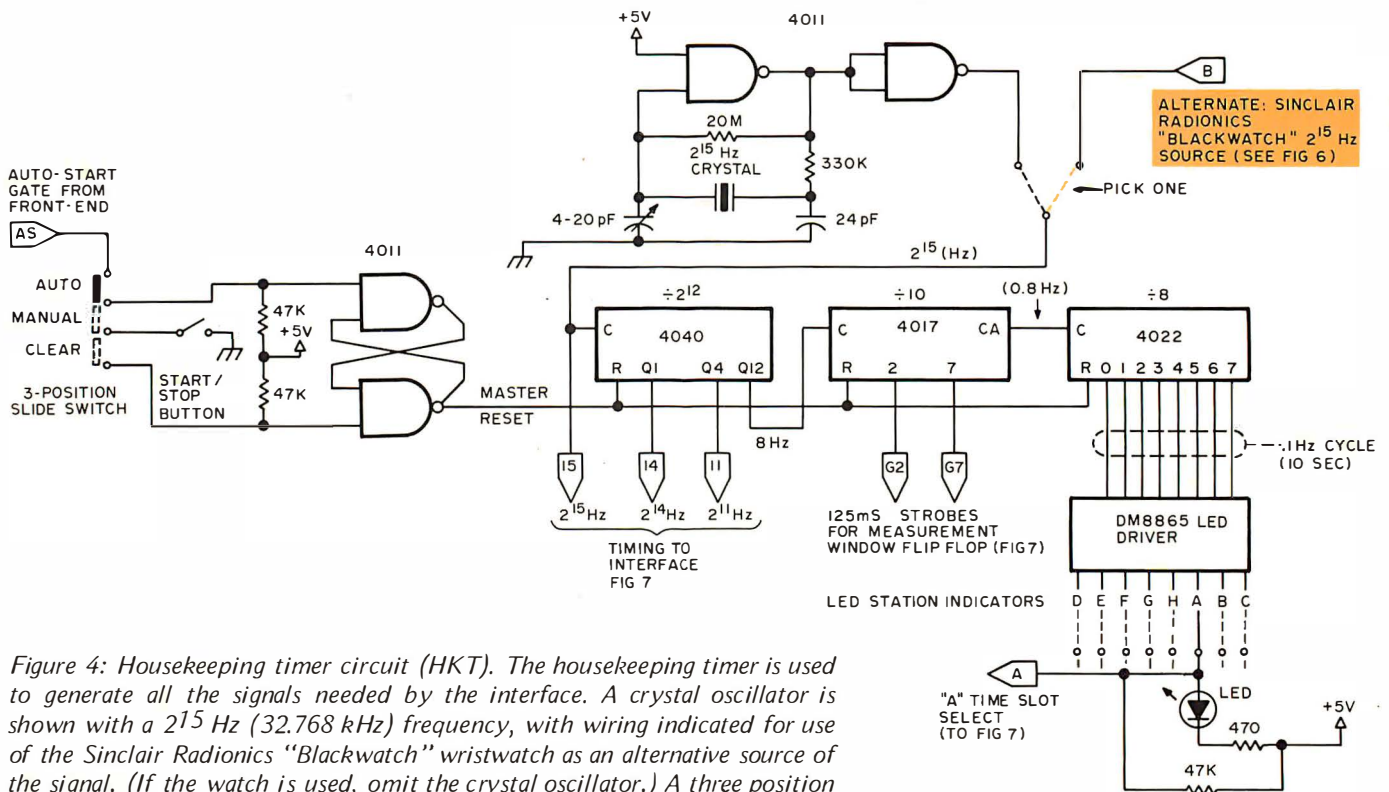

Figure 4: Housekeeping timer circuit (HKT). The housekeeping timer is used to generate all the signals needed by the interface. A crystal oscillator is shown with a 2^{15} Hz (32.768 kHz) frequency, with wiring indicated for use of the Sinclair Radionics "Blackwatch" wristwatch as an alternative source of the signal. (If the watch is used, omit the crystal oscillator.) A three position slide switch is used to control operation modes, which include automatic start, manual starting or a clear operation. The LED display driver outputs of the DM8865 provide a continuous monitor of the Omega cycle, and the A slot is monitored by the interface to the computer to give software a timing reference to stations.

diagram of figure 3. The idea here is to adjust the comparator such that it will provide a square wave output with as low as 10 mV peak-to-peak input centered on about $V/2$. This threshold will correspond to about 10 μ V peak-to-peak at the antenna terminal (about 3 μ V rms) which is usually well below the antenna noise level when the gain ahead of the comparator is about 60 dB. The front end gain will be about 20 dB for the preamplifier plus a minimum of 40 dB for the filter and limiter which provides 60 dB total. More gain can be provided if required by changing the amplifier feedback resistors on the active filters as mentioned previously. Thus the zero crossing comparator should provide an output square wave for essentially all signals and noise when the antenna is connected to the preamplifier. The output of the comparator is a hard limited square wave, but the filter-limiter circuit has what is known in the trade as a clipped linear characteristic. The edge position of the comparator square wave contains the basic phase information of the Omega signal plus the noise developed at the antenna within the filter bandwidth used.

The other sections of the comparator are used to provide an envelope output signal

with a peak detector and an adjustable threshold gating circuit. The peak detector drives a signal level indicator which is handy for observing strong signals like the North American D channel on 10.2 kHz, as well as the overall receiver noise level. The meter should kick upscale slightly when the antenna is connected even in a very electrically quiet environment. The typical noise level in the 10 kHz region will vary from 10 μ V to 100 μ V per meter of antenna length (assuming a perfect energy transfer at the antenna) for a receiver bandwidth of 15 Hz or so. The Omega signals will vary from a low of about 10 μ V to a high of 1000 μ V depending on the range of the observer to the Omega transmitter. The noise level during local thundershowers can be much greater than the signal, and 60 Hz harmonic interference can often completely obliterate Omega signals as observed on a scope attached to the radio frequency front end. However, the digital processors which follow the zero crossing edge output can track signals buried in a large amount of noise with proper programming. [Software is the touchstone of computer applications.]

The adjustable threshold gate is used as an automatic start signal for operating the housekeeping timer (HKT) circuitry. We usually also connect an LED from +5 V through a 330 ohm series resistor directly to this gate output point to indicate when the strong D channel is on. An audio beeper

circuit connected at this point is also a handy device when first starting to observe Omega signals. This amplitude gate output is zero when on, so it operates as a current sink when driving external digital interface hardware. We have found that this circuit will start the digital logic operating 95% of the time or more, even in the presence of a lot of noise because the D channel Omega signal is quite strong for most observers in North America. For others, a manual start option is provided in the housekeeping timer circuit, and for the very sophisticated user, an automatic synchronization routine can be developed using the microprocessor with appropriate software.

Housekeeping Timer and Local Clock Oscillator

In order to operate an Omega receiver it is necessary to have some sort of timer circuitry and reference clock oscillator. The timer provides a means of telling the receiver which stations are being received, and the clock provides a reference for comparing the phase differences among stations. The clock oscillator drives the timer circuitry through an appropriate series of divider stages. A very simple housekeeping timer circuit based on a clock frequency of 2^{15} Hz is shown in figure 4.

A 32.768 kHz quartz crystal of the type found in digital wristwatches is used. The timer circuitry here provides a number of very convenient gating and control signals for operating external microprocessors or hardware digital sensor systems. The timer is started with a master reset gate (MR) obtained from the front end automatic start output or from a manual pushbutton. A set-reset flip flop holds the timer on as long as the receiver is operating. The timer can be reset by switching to the stop position (or clear) and momentarily operating the same

control pushbutton. The housekeeping timer tells the receiver user where the Omega sequence is with LED indicators. For a microprocessor interface only one of the stations need be selected to identify where the Omega sequence is, such as starting at the A or D channels. Beginners might find that a string of eight LEDs, one for each time slot, is a value in understanding the operation of the Omega sequence.

A uniform measurement window method has been used in this housekeeping timer circuit. If the clock is started at the beginning of the D Omega time slot, then the sequence of gates is as shown in figure 5. A measurement window for each Omega time slot is obtained with additional clear, stop, and read gates for each one. The measurement window width can be altered by starting on pulse 1 and stopping on 8 instead of 2 and 7 as shown in figure 4. The goal here is to provide an easy way of telling the microprocessor when the measurement is valid. The HKT generates eight time slots every 10 seconds with 10 shorter 125 ms control gates for each one under the option of whatever the user desires to program.

Clock Adjustments

The 32.768 kHz clock should be adjusted for an offset of 5×10^{-6} or less. A reasonably good frequency counter with a built-in 1 MHz temperature compensated crystal oscillator time base can be used. First adjust the trimming capacitor on the clock oscillator to read 32.768 with a 1 second counter gate time. Then adjust for 32.7680 with a 10 second gate time. If a period averaging feature is available on the frequency counter, 10^4 periods of the 32.768 frequency will result in a number like 30.51757 microseconds which gives a reading of ± 3 parts in 10^7 precision with respect to the frequency counter time base crystal. If you

Photo 4: The RF preamplifier, shown built with a homebrew printed circuit board and mounted in a shielded metal housing. The antenna is mounted at the left, with the connection to the receiver front end box via coaxial cable at the right.

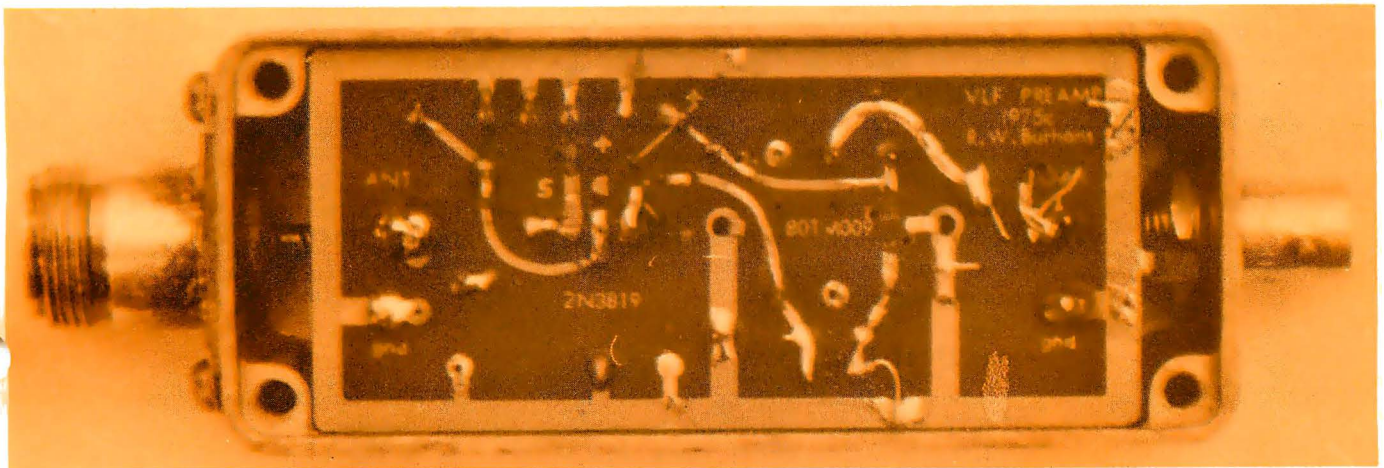

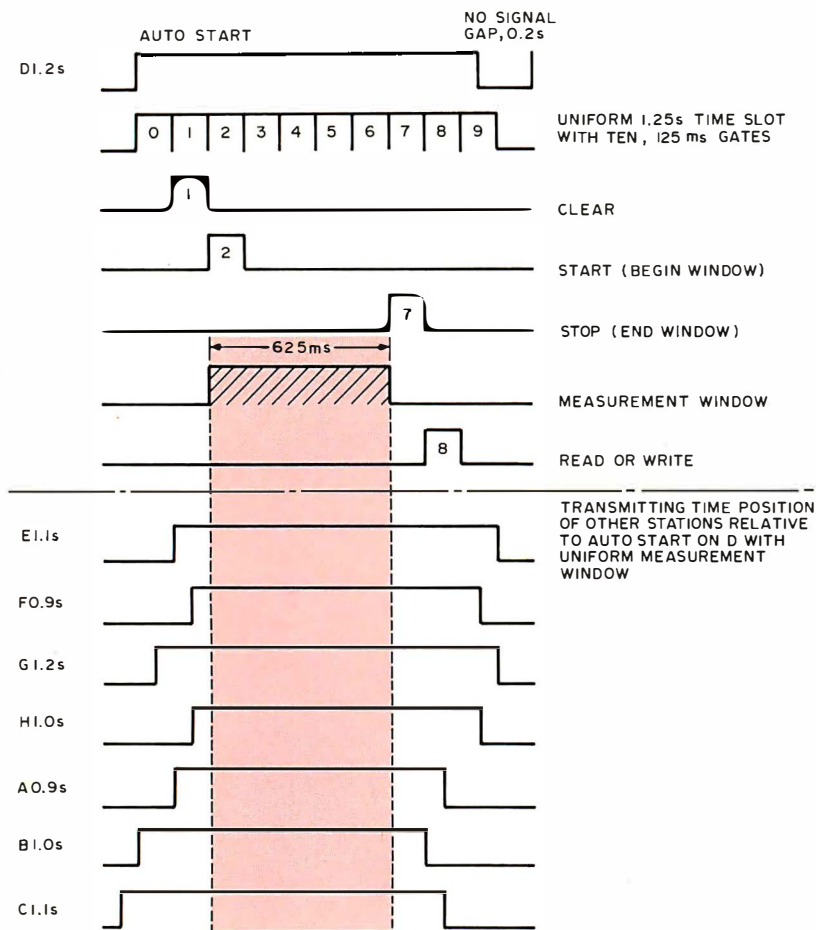

Figure 5: Timing diagram, showing how the logic of figures 4 and 7 combine to produce a hardware defined measurement window which will validly sample a segment of the signal from each station. The diagram assumes that the automatic start begins on the leading edge of the signal from the D station. The portion of the transmission interval between dotted lines in the E, F, G, H, A, B and C station signals is monitored by the Mini-O software through the interface.

do not have a frequency counter, the nearest CB repair shop usually does, and the clock may be carried to the frequency counter location for initial adjustment. Once adjusted the clock may be operated in the on-off mode with occasional checks using the Omega signal to estimate the offset for periodic recalibration.

Commercial and military Omega receivers often use a temperature compensated crystal oscillator clock on a frequency like 2.611200 MHz ($2^8 \times 10.200$ kHz). Suitable divider chains can be easily assembled to generate all of the Omega time slot functions from this particular frequency. It is also possible to devise frequency synthesizer circuits based on 5 MHz standards and some receivers have an atomic clock reference for use in the direct ranging mode. The 2^{15} Hz watch crystal oscillator provides adequate stability when treated with some care and is many orders of magnitude less expensive than other methods.

Other 2^{15} Hz Clocks

A Sinclair Blackwatch or the Westclock GT-500 wall clock movement have been used to provide the 2^{15} Hz signal with an

isolating high impedance buffer amplifier. A circuit to modify the Sinclair watch kit is shown in figure 6. The output of this circuit is used to drive the oscillator of figure 4 by removing the crystal from the circuit of figure 4 and driving between ground and the input side of the oscillator gate right across the frequency trim capacitor. The GT-500 clock requires an additional 4024 divider stage to generate 2^{15} Hz from the crystal frequency of 2^{21} Hz.

Marine navigator types might find that a clock such as the Sinclair Blackwatch which has a digital display for time of day in hours-minutes, or minutes-seconds, is of value also as a celestial navigation chronometer. Once the clock has been properly adjusted, the user can even estimate when the D channel should be operating by keeping track of the clock offset on a daily basis using the seconds readout. The Sinclair watch kit can provide better than 1 second per week offset with respect to Omega. Thus the receiver user can also start the receiver manually by operating the pushbutton when the estimated D channel second interval is displayed on the clock readout. The gating system of figure 5 with uniform time slots is designed such that errors up to a quarter of a second can be tolerated and still provide some measurement window. The automatic starting gate will start using the strong D channel within 50 ms of the correct station spacing illustrated in figure 5, and manual push to start operation can be achieved within 100 ms with some practice in "clock watching."

Microprocessor Interface

The next step in the receiver operation involves converting the 10.2 kHz Omega zero crossings to a sampled set of 6 bit numbers. First a single chip rate multiplier, an RCA CD4089BE, multiplies the 32.768 kHz frequency by 5/16 to generate 10240 zps (zero crossings per second) clock rate. There will be some jitter at the LSB rate but this will wash out in the processor which needs only six of the eight bits for Omega use.

The Omega zero crossings are fed to a digital mixer circuit consisting of one D flip flop ($\frac{1}{2}4013$) and mixed with 2^{11} Hz obtained from the housekeeping timer circuit of figure 4. The mixing formula here is:

$$IF = f - (m+1) 2^n$$

where:

IF is the intermediate frequency in Hz,
 f is the input frequency,
 m is the harmonic number of 2^n Hz

synchro-sound enterprises

“THE COMPUTER PEOPLE”

NEW

ADM - 3A VIDEO TERMINAL
WITH ADDRESSABLE CURSOR

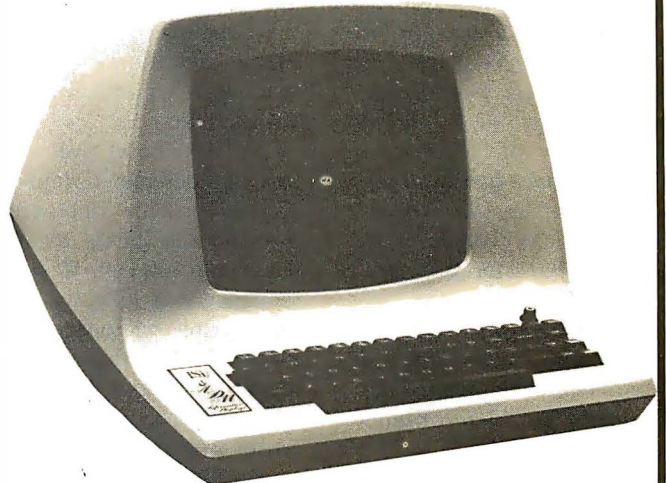
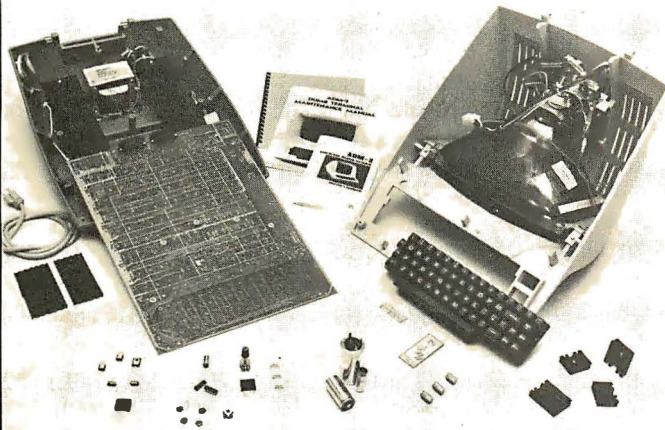

ADM - 3A (24 X 80) 895.00 KIT 1149.95 ASSEMBLED
LOWER CASE 95.00

ALSO FEATURING

IMSAI, TDL Z-80, SWTPC, PROCESSOR TECHNOLOGY,
APPLE COMPUTER, CROMEMCO, TARBELL, VECTOR
GRAPHIC, OEA.

UNITS IN STOCK FOR IMMEDIATE SHIPMENT.
FULL SERVICING ON PREMISES ON ALL UNITS WE SELL.

WORKING MODELS ON DISPLAY AT OUR NEW SHOWROOM

CALL OR WRITE FOR
DISCOUNT PRICE LIST
PHONE ORDERS
(212) 468-7067

All IMSAI products in stock for immediate delivery.

MASTER CHARGE

STORE HOURS 9-5
TUESDAY - SATURDAY
SYNCHRO-SOUND ENTERPRISES

193-25 JAMAICA AV

HOLLIS NY 11423

BANKAMERICARD

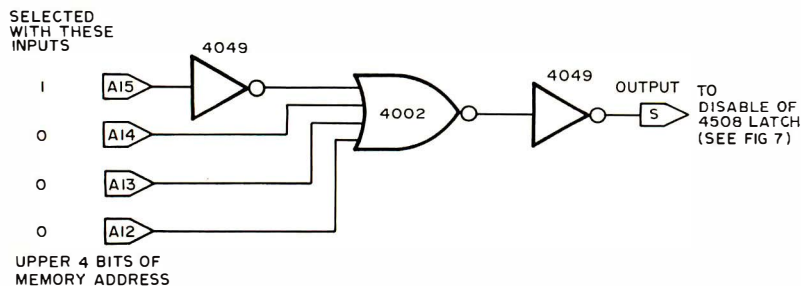

Figure 8: Partial address decoder. In a small system, where only a portion of the total address space is actually used, it is possible to get away with partial decoding of addresses. This decoder lumps all addresses of the form hexadecimal 8xxx together as the (single) address for the Omega interface; for systems where memory address space utilization is a problem, other address decoding configurations should be used.

microprocessor can do this job as well as all the remaining computation to output some useful navigation information and still have space left for whatever the system designer wishes to do.

At this point we leave it up to the software designer to implement a navigation system on the microprocessor. We have supplied raw phase data at a suitable low data rate (40 Hz), a collection of Omega sequence and time signals for interrupt and control of microprocessor functions, and means of identification of where the Omega sequence is at a particular time. The first stage in programming involves developing sensor processor filtering of the data down to the lines of position level. The simplest marine receiver might require only two lines of position outputs. Further sophistication would involve conversion to latitude and longitude, range angle, diurnal corrections, multiple frequency redundant systems, differential corrections, etc. The next article in this series, by Richard Salter of our laboratory, presents some of the sensor software details.

Test Equipment Recommended

The Mini-O receiver system is intended for fabrication by those skilled in modern electronic circuit arts. It is not recommended for the total novice. Access to some test equipment is required for alignment and checkout. An oscilloscope, preferably a triggered sweep model, a stable audio function generator, and a frequency counter with a quartz crystal time base, are suggested.

The function generator should be capable of tuning the range of 5 kHz to 20 kHz with some reasonable stability (with an internal regulated DC supply) and a tuning rate such that the frequency of 10.200 kHz may be set to within a few Hertz. The adjustment of the very narrowband front end requires setting the function generator to the center frequency of 10.200 kHz and this should be checked with the aid of a frequency counter operating in parallel or triggered from the function generator synchronizing output. We have used the EXAR model XR-2206KA kit

(available from James Electronics, POB 822, Belmont CA 94002, for about \$18 as a basic chip plus circuit board). This provides a convenient squarewave output for checking frequency in parallel with the sine wave output. A good quality logarithmic tuning potentiometer is required in these types of function generators.

The frequency counter should have a 10 second time base with a quartz crystal reference that is accurate to within $\pm 1 \times 10^{-6}$, or has a low offset. If you do not have this item, many radio amateurs often use them in their shacks, as well as CB repair shops. Some frequency counters have provision for using an external time base which can provide the required precision for initial adjustment of the 32.768 kHz clock oscillator. The Sinclair Blackwatch kit also has instructions for adjusting the offset using WWV time ticks on the high frequency (short wave) radio bands. This takes longer than using a good frequency counter but is adequate for the patient experimenter. For the experimenter who is involved with time and frequency measurements, a good 1 MHz secondary standard is suggested. Many oven controlled crystal oscillators are on the surplus market. (Herbach and Rademan, 401 E Erie Av, Philadelphia PA 19134, has several with proportional oven controls in the \$30 to \$50 price range; a reasonably priced temperature compensated crystal oscillator is available from Bliley Electric Co, 2545 W Grandview Blvd, Erie PA 16508, the model TCCO which requires 26 mA +5 VDC and costs about \$75.)

Some experimenters might even wish to consider the possibility of using an external 1 MHz frequency standard as the microprocessor clock system so that all of the timing functions could be accomplished with precision using the microcomputer itself without ever using a special purpose Omega clock in the interface.

When using an oscilloscope, it is suggested that most measurements be made with a low capacitance probe so that the waveform displayed will not be distorted by the lead capacitance to the scope. When observing the input signal at the preamplifier output terminal or at the input to the front end, an ordinary coaxial lead to the scope may be used because the impedance at this point is about 680 ohms. However, the output of many of the CMOS logic circuits is a much higher impedance, and distortion of the actual waveform will take place unless a low capacitance probe is used. The CMOS logic circuits will tolerate up to something like 130 pF additional capacitance, but this can distort a 1 MHz signal. ■

Acknowledgments

At Ohio University we have been developing low cost Omega navigation systems (ONS) for use by the general aviation community. The Mini-O system described here is a spinoff of some of the simpler ideas. Part of the work reported here has been supported by NASA Langley Research Center, Grant NGR 36-009-017, under the Tri-University Program in Air Transportation. The aid and support of Dr R H McFarland, Dr R W Lilley, Prof G E Smith, R J Salter, Lee Wright, Kent Chamberlin, Dan Moyer, and Ralph Smith are much appreciated on the project results.



FLIP OVER OUR FLOPPY

Only \$750 from Peripheral Vision.

Peripheral Vision is a brand-new company that's dedicated to selling reasonably priced peripherals for various manufacturers' CPU's.

We think you'll flip over our first product.

It's a full-size floppy disk for the Altair-Imesai plug-in compatible S-100 BUS. And it's available for as low as \$750.

Here are the features:

- 1 interface card supports 4 drives
- Stores over 300,000 bytes per floppy
- Bootstrap EPROM included—no more toggling or paper tape
- Completely S-100 plug-in compatible
- Interface cabling included
- Drive is from Innovex (the originator of the floppy concept)—assembled and tested
- Interface card design is licensed from Dr. Kenneth Welles and the Digital Group
- Disk operating system with file management system included on floppy
- Cabinet and power supply optional

Prices:	Kit	Assm.
Interface card kit and assembled and tested drive	\$750	\$850
Power supply— +24V at 2A	45	65
Cabinet—Optima, blue	—	85

Now, a little more about our company.

Peripheral Vision may be brand-new, but we have some old-fashioned ideas about how to run our business.

We know there are serious incompatibilities among the

different manufacturers' peripherals and CPU's. We want to get them together. And, we want to bring significant new products to market—products consisting of everything from adaptation instructions/kits for hardware and software to major new products.

It's a tall order, but we feel we're up to the task. Peripheral Vision has already obtained a license from The Digital Group to adapt versions of some of their products to the S-100 BUS. And we're working on getting more from other companies.

Most important to our customers, Peripheral Vision is committed to helping you get along with your computer. We'll do all we can to make it easy.

Write us now for all the information on our company, our philosophy and our exciting line of products. And be prepared to flip over all of it.

PERIPHERAL VISION

P.O. Box 6267 / Denver, Colorado 80206 / (303) 733-1678

Send me the works, and I just might flip over it!

Name _____

Address _____

City/State/Zip _____

attempting to sell the user the idea that the DEC PDP-8 that drove the reader would fit in the palm of his hand in a few years. The Intel 8008 was just out, and those outside the integrated circuit world could not understand its potential.

In printers' terms the paper has a line screen of 25% density, similar to a printed photograph. All we did was to place the dots where we wanted them. To do this the RCA Vidio-comp was driven with our dot "font." The worst problem in producing the master was that the technicians adjusting the Vidio-comp did not really do a good job on the sweep linearity. It wasn't necessary in text, but it really came out in our reader. The data is encoded in a phase-like method where along the scan line the black dot is placed to either the right or left side of the cell, thus a black white or a white black. When scanned and converted to an analog signal, you have either a positive or negative transition at the cell center the same as many cassette tape recorders. This was done as we had just finished a cassette recorder design. The reader has a three cell scan head. Two cells track the line, and the third is the data cell. The organization is like a disk, where the first few lines at the beginning are a disk directory — in this case chapter paragraph line number starts. You can use the runout on each side to count your position the same as a disk head position encoder.

If anyone wants more information please contact me, C R Conkling Jr, at POB 310, Shoreham NY 11786, (516) 744-9475.

GRAY SCALE?

I am following your series of articles on the optical bar code readers with great interest. Basically I agree with Messrs Banks and Sanderson (December 1976 BYTE, page 12) that optical bar code readers and low cost printing will be "the way to fly." I would add that software would best be distributed as source code, although the technique could obviously be used for source or object code. I would suggest that the suggested format (figure 2, page 16) be enlarged to include a one byte "record type" code. This would allow for a far more flexible system at very small cost.

I borrowed my son's (inexpensive) microscope and gave the sample bar codes (figure 4, page 17) a close look. One thing became quickly apparent: Even on the low density sample a lens system of at least 200X was required! Any less and I could see more than one bar at a time. Secondly, holding the paper flat to prevent misfocusing was a problem. The high density samples had a problem obvious to the unaided eye — the ink smeared (see copy enclosed). My experiment indicated that your sample (e) was about the best. Sample (c) came close, but might present problems in tracking.

Several thoughts on the subject: Some form of audio feedback from the computer (have the processor make a "click" noise by toggling a one bit output port into a speaker) would help maintain the correct scan rate and tell when you had strayed off the track. Perhaps the bar code system is not the ultimate way to go; how about a "gray scale" — you could print white, 33% halftone, 66% halftone, and black (giving four levels) or what have you. The halftone system would allow printing of wider bars while yielding high bit density, thus reducing the requirements of the lens system. One final thought: With proper forethought, the bar code "pencil" could double as a "light pen."

Please keep up the good work, especially on this subject. I believe you are on to something very worthwhile.

Carl K Zettner W5HFG
108 Moss Dr
San Antonio TX 78213

As noted earlier (see January BYTE, page 11) the smearing of the high density samples and variability of the spacing rule out their use. The actual problem can be attributed to a nonuniformity in the response of the photographic preparation of the plates for the print run, since the smearing was seen in our "blueprint" proof copy of December BYTE.

The magnification of the optics is not the problem; rather it is the aperture of the lens, and masking of that aperture so that only one bar width at a time is viewed. The slit method (see comments in another section of this forum) shows good promise as an inexpensive but quite usable form of optics for bars such as those we've printed in recent tests. The larger the area of the opening, the greater the amount of the bar which is sensed. The narrower the effective aperture (whether or not a lens is used), the higher the density can be made.

NRZ, ANYONE?

I was very glad to see your article on bar coding, and I hope it will be a success. There are a couple of improvements I'd like to see, though.

Since you're printing the bar code, won't you please print the same data in human readable form, too? The Universal Product Code has the numbers printed. Punch cards have their problems, but at least with them you can tell exactly, character for character, what's going into the machine. With paper tape (or your bar code formats) you can puzzle it out, but only with a lot of work. Of course, with magnetic tape there's no hope. You're suggesting 50 bits per inch [not anymore] so you could print the corresponding hexadecimal characters immediately below the bars at 12.5 characters per inch. (I've found 12 to 21 characters per inch in BYTE articles.) Of course, if you're printing ASCII characters, the characters

themselves could be used instead. If a misprint keeps one frame of bars from being read, I'd sure rather key in 125 hexadecimal characters than 500 painfully deciphered bits.

Since bar codes can be the same as saturated magnetic tape codes, I'm surprised you didn't suggest the NRZ (Non Return to Zero) code. In it, the medium is divided into equal cells. A transition (from white to black or black to white) in the center of a cell represents a one, while no transition represents a zero. A transition also occurs at the end of every cell for timing. Although more difficult to read manually than your formats two or three, this code has even spacing and is more compact:

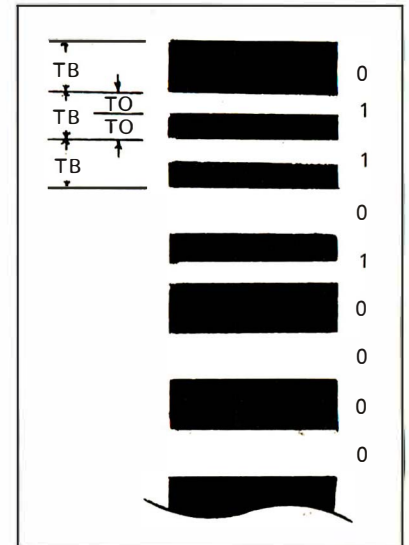

If we assume, in each of these formats, that the short spaces and bars are half the width of the long spaces and bars, and that 50 bits per inch is a reasonable density for format 2, we can calculate the corresponding densities for the other formats:

Format	Density (bits per inch)
1	75-150, average 100
2	50
3	50-75, average 60
NRZ	75

[We have to figure out how to do it first... but maybe...]

I think the NRZ code with hexadecimal or ASCII characters would be a good compromise.

To encourage use of your bar code standard, BYTE could offer to convert data from tape to bar code for anybody at a standard price. That way other magazines, particularly those on small budgets like club newsletters, could use it. If it were only a few dollars a page, bar coding would be cheaper than cassettes (though slower to read) even for a "production run" of half a dozen!

Finally, a hard copy printer or even a typewriter can print a low density bar code: 010001101 can be scanned right

now open—the total
experience computer stores

Computer Shack

top values, professionalism

Computer Shack stores are exciting, enjoyable places to visit. From the striking interior decor to the fun and challenge of the GAME ROOM, you'll find Computer Shack stores a completely new computer shopping experience.

You can count on Computer Shack stores for total professional support whether your needs are those of a computer hobbyist, education, science or business user. The skilled, management-trained staff offers knowledgeable service, expert maintenance, and software guidance.

quality products

At Computer Shack stores the emphasis is on quality products. Featured are the finest in microcomputers, interfaces and peripherals, including the full IMSAI line. Every store is completely stocked with tools, books and a complete line of accessories.

SALE OF THE MONTH

This month all Computer Shack stores feature—\$50 saving on Vector Graphic 8K RAM purchased with IMSAI 8080. Each board purchased this month comes with a free \$7.00 IMSAI Edge Connector.

beginners welcomed

Do you want to get started with microcomputers? Are you seeking expert guidance on computers, peripherals, software? The place to visit is your nearest Computer Shack.

Watch your local newspaper for Computer Shack openings. Each store features a monthly Sales Special.

computer shack

14860 Wicks Blvd.
San Leandro, CA. 94577
(415) 895-9363
Franchise Opportunities
Available

down the center of the characters! [See Fred Howard's letter.]

Keep up the good work.

James R Van Zandt
26 Shelton St
Nashua NH 03060

Using software (although this may be premature), NRZ may very well be much more complicated to decode. But it may be worth trying. Since the format of the light and dark we print has no bearing on the hardware, provided we use bars with physical minimum size parameters set by an aperture standard, it only requires a night or weekend's worth of software and some experiments with PC layout tape, white paper, a darkroom and a camera to try out a different format at the bit level. In actual program object or source code, we plan to print an exact hexadecimal map of each bar code frame, thus allowing both hand and machine readable data entry.

SPACES CARRY NO INFORMATION?

Harold Mauch sends us this commentary, which we print with a few words at the end:

I would like to take exception to the choice of proposed format for the "Machine Readable Printed Software" described on pages 12-17, BYTE magazine for December 1976. Of the three formats described, the selected format (format 3, page 14, figure 1) has the least going for it.

- It is lower density than format 1 since the spaces carry no useful information.
- Contrary to the assertions of the author, the spaces provide only a marginal reference for discriminating wide from narrow bars.
- The hardware and/or software needed to implement format 3 is more complicated than that required to read either format 1 or 2.

Examination of the test strings on page 17 indicate the typesetting, lithographic and printing process is far from "perfect" in maintaining bar to space ratios. To compensate for this imperfection, author Keith Regli added a "bias computation and adjustment" to the space count, thus complicating the software.

Such ad hoc measures could be eliminated with format 1. The printing process maintains excellent bar to bar and space to space ratios, but poor bar to space ratios. The lithographer may have over or under exposed the plate or the printing press may be running too much or too little ink. A more satisfactory approach for discriminating between wide and narrow bars is to compute the average of known wide and narrow bars (add the counts and shift left once). This provides a discrimination threshold with which other bars in the local area may be compared. The same procedure would

apply to wide and narrow spaces. Even with the addition of reference bars and spaces, the average data density of format 1 is 33% greater than format 3 and 60% greater than format 2.

While on the subject of reference bars, format 3 needs them also. If the data is a string of zeros, I claim that the printing variations evident in the test strings on page 17 will eventually confuse the decoding algorithm. This can be resolved by adding a reference or parity bar, preferably to each 8 bit byte. This required addition thus gives format 1 a 50% density advantage over format 3.

I presently use and prefer a signal conditioner circuit nearly identical to that described in author Merkwowitz's article (page 81, figure 3). The super differentiator circuit of figure 4 is better for low density waveforms since the photo sensor output is nearly a square wave. However, when bar and space width is decreased to the dimension of the photo sensor's effective aperture (0.005-0.010 inch in my equipment), the photo sensor output looks more like a sine wave which does not differentiate into the narrow pulses required by the threshold comparator of figure 4.

One final note: My experience is that timing bits alluded to in figure 2, page 16, are required, not for timing, but to permit the signal conditioner detectors to stabilize. Referring to figure 3, page 81: When the photo sensor is resting on the white page before a line of code is scanned, the peak detectors will decay to the "white" level. This creates a severe white bias until the "black" peak detector stabilizes. The result is that the measured duration of the first few bars and spaces of a line will be grossly distorted and not suitable for data.

Harold A Mauch
Director of Engineering
PerCom Data Co
4021 Windsor
Garland TX 75042

The point about format 1 versus format 3 needs some comment. First, the format 3 spaces do carry useful information - they give the timing values needed to discriminate bit widths. The bias calculation is required also in format 1, which will suffer from the same problems in the switching of the levels. (This problem is caused by the tendency of the system to take different amounts of time to change state from black to white than vice versa.) By using explicit black marks for each bit, at least we are guaranteeing that each bit has the same biases (one rising edge to black, one falling edge to white). We don't care about bar to space ratios other than the fact that they are locally constant within a space of several bits retained in the running average of the input algorithm.

The startup bias also depends upon your detector design, and later conversations with several engineers suggests that the circuits of Fred Merkwowitz's articles are overly complex for this application... CH ■

ALTAIR COMPUTER CENTERS

BEAVERTON, OR 97005

8105 SW Nimbus Ave.
(503)-644-2314

BERKELEY, CA 94710

1044 University Ave.
(415)-845-5300

SANTA MONICA, CA 90401

820 Broadway
(213)-451-0713

DENVER, CO 80211

2839 W. 44th Ave.
(303)-458-5444

ALBUQUERQUE, NM 87110

3120 San Mateo N.E.
(505)-883-8282; 883-8283

TUCSON, AZ 85711

4941 East 29th St.
(602)-748-7363

LINCOLN, NB 68503

611 N. 27th St.
Suite 9
(402)-747-2800

LITTLE ROCK, AR 72206

2412 Broadway
(501)-371-0449

TULSA, OK 74135

5345 East Forty First St.
110 The Annex
(918)-664-4564

HOUSTON, TX 77036

5750 Bintliff Drive
(713)-780-8981

RICHMOND, VA 23230

4503 West Broad St.
(804)-335-5773

SPRINGFIELD, VA 22150

6605A Backlick Rd.
(703)-569-1110

CHARLESTON, W. VA 25301

Municipal Parking Building
Suite 5
(304)-345-1360

EAGAN, MN 55122

3938 Beau D'Rue Drive
(612)-452-2567

ANN ARBOR, MI 48104

310 East Washington Street
(313)-995-7616

WINDSOR LOCKS, CT 06096

63 South Main Street
(203)-627-0188

PARK RIDGE, IL 60068

517 Talcott Rd.
(312)-823-2388

ST. LOUIS, MO 63130

8123-25 Page Blvd.
(314)-427-6116

NASHVILLE, TN 37203

1600 Hayes St.
Suite 103
(615)-329-1979

BURLINGTON, MA 01803

120 Cambridge St.
(617)-272-8770

ALBANY, NY 12211

269 Osborne Road
(518)-459-6140

NEW YORK, NY 10018

55 West 39th St.
(212)-221-1404

ATLANTA, GA 30305

3330 Piedmont Road
(404)-231-1691

TAMPA, FL 33614

5405 B Southern Comfort Blvd.
(813)-886-9890



3330 Peachtree Road, Suite 343
Atlanta, Georgia 30326

Have you written Software for your Altair^{T.M.} Computer?

The Altair 8800 computer was the first micro produced for the general public and remains number one in sales, with more than 8,000 mainframes in the field. The wide acceptance of the Altair computer and its rapid adaptation to many diversified applications has truly turned the dream of the affordable computer into a reality.

Yet the machine itself, remarkable as it is, represents only the beginning. The right Software, tailored to meet a user's specific requirements, is a vital part of any computer system. MITS wants to insure that Altair users everywhere have the best applications software available today and in the future. For this reason, a new MITS subsidiary, the ALTAIR SOFTWARE DISTRIBUTION COMPANY, has been formed. Its purpose: to acquire the highest quality software possible and distribute it nationally through Altair Computer Centers.

That's where you come in. The ASDC will pay substantial royalties to the originators of all software accepted into the ASDC library. If you have written business, industrial or commercial use software for the Altair 8800, ASDC wants to hear from you. It is the aim of the ASDC to stimulate and reward creativity in producing useful software that makes those dreams of "computers for everyone" come true. The ASDC will select only software that measures up to its high standards for system design, coding and documentation. The software will then be further documented and distributed through Altair Computer Centers around the country.

For more information on how to submit software to the ASDC, Altair Computer Center for an ASDC Software Packet or contact the ALTAIR SOFTWARE DISTRIBUTION COMPANY.

submit software to ask your Local Computer Center for an Software Submittal or contact the ALTAIR SOFTWARE DISTRIBUTION COMPANY.

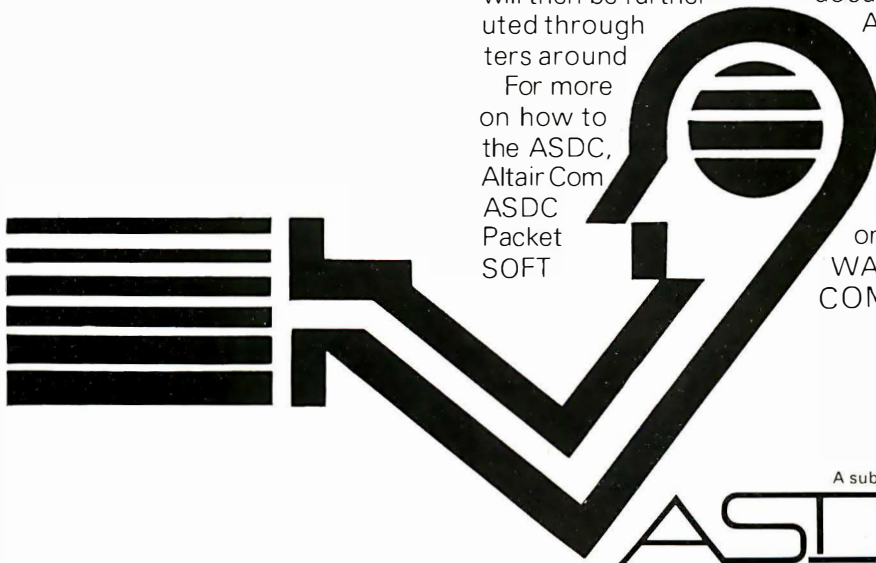

ALTAIR SOFTWARE DISTRIBUTION COMPANY

3330 Peachtree Road, Suite 343 Atlanta, Georgia 30326 404-231-2308

BITS™ Presents:



Please note: Although our ads will change month to month, with few exceptions all previous books advertised are available through BITS. A complete catalog will be sent to you with your order. . . . FWR

— **TV Typewriter Cookbook** by Don Lancaster. A complete guide to low cost television display of alphanumeric data, several chapters of which were published ahead of the book in early issues of BYTE magazine. \$9.95

— **Digital Logic Circuits** by Sol Libes. An invaluable tutorial background volume on digital logic, arithmetic, IO concepts and interfacing to analog devices; written by one of the founders of the Amateur Computer Group of NJ. This book acquaints the reader with much of the terminology and background concepts of digital hardware. \$5.98.

— **Modern Operational Circuit Design** by John L Smith. An absolutely essential introduction to the use and application of operational amplifier systems. The book contains both theoretical background information and practical circuit suggestions which can be used to advantage by the experimenter. \$16.95 (hardbound).

— **Electronic Projects for Musicians** by Craig Anderton. "Even if you know nothing about electronics, you can build preamps, ring modulators, mixers, tone controls, min-jampls, fuzzes and a dozen other inexpensive musical projects." Furthermore, even if you couldn't care less about about musical applications, you can use this book to gain familiarity with electronic parts, circuit diagrams and construction techniques, using the wealth of illustrations and tips found in an extended introductory chapter for the novice electronicker. \$6.95.

— **Active Filter Cookbook** by Don Lancaster. The chief chef of electronics Cookbooks concocts another gourmet appetizer. Run to this book when you need to find a starting point for the design of a filter for use in an electronic application. \$14.95.

— **Altair Design** developed by Ensor Holiday.

— **More Altair Design** developed by Ensor Holiday.

— **Altair Design 3** developed by Ensor Holiday.

Keep the loved ones busy while you use your system . . . give them any one or all of these computer generated **Altair Design** books to start them (or yourself) on endless hours of creative coloring. No other coloring books are quite like these unique books. \$2.50 each.

— **Artist and Computer** edited by Ruth Leavit. A visual treat, as you encounter reproductions of numerous works by computer oriented artists and read about these works in their own words. \$4.95.

— **Linear IC Principles, Experiments, and Projects** by Edward M Noll. From basic principles to complicated systems, from simple amplifier experiments to applications in radio, TV and control systems, this book can improve your knowledge of the way circuitry of the analog world really works. \$8.95.

— **Practical Solid-State Circuit Design** by Jerome E Oleksy. A self study course in the design of semiconductor circuits from the simple transistor to the complex operational amplifier. \$5.95.

— **Boolean Algebra** by Brice Ward. A background tutorial and study guide for the design and simplification of static networks of logic gates. Learn how to combine those ANDs, NANDs, NORs and ORs to evaluate complicated logical conditions of multiple inputs, electronically. \$5.50.

— **Projects in Sight, Sound & Sensation** by Mitchell Waite. Dedicated "to all space cowboys." Detailed theory and practice of seven fascinating amateur electronics projects, along with a complete and detailed appendix on how to make PC boards. \$4.95.

— **Creativity, Invention, & Process** by John A Kuecken. Practical philosophy and history for the inventor. \$3.50.

— **Security Electronics** by John E Cunningham. To catch a thief, apply liberal doses of ingenuity and a modicum of cleverness. Find out what's been tried in conventional alarm systems before you go off computerizing your home security system, though. \$4.95.

— **Introduction to Biomedical Electronics** by Edward J Bukstein. What's been done in robot doctors? Nothing so far. But in terms of electronic aids to physicians and practices of health researchers, consult this background review of the field of biomedical electronics. \$5.50.

— **What to Do After You Hit Return of PCC's First Book of Computer Games.** This is PCC's first book of computer games, a compendium which includes descriptions of numerous games, and listings of 37 selected BASIC games. \$8, new second edition.

Send to:

BITS, Inc
70 Main St
Peterborough NH 03458



Check payment method:

My check is enclosed

Bill my MC No. _____ Exp. date _____

Bill my BAC No. _____ Exp. date _____

Name _____

Address _____

City _____ State _____ Zip _____

Signature _____

Total for all books checked \$ _____

Postage, 25 cents per book

for _____ books \$ _____

Grand Total \$ _____

You may photocopy this page if you wish to leave your BYTE intact. Please allow six weeks for delivery.

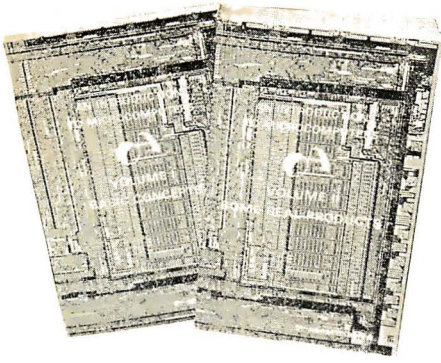

Adam Osborne's books **An Introduction to Microcomputers, Volumes 1 and 2**, are a concise compendium of the technical details of microprocessors at the component (engineering) level. These are the source books for the system designer who plans to employ the microprocessor, or the advanced homebrewer who wants a dash of customization not found in commercial products.

— Volume 1 is subtitled "Basic Concepts." This is the book which presents a framework of ideas concerning the design and use of small computers implemented with LSI. Topics include definitions of the microcomputer, fundamental concepts of logic and numbering characteristics of instruction sets, etc. \$7.50.

— Volume 2 is a much thicker (895

page) detailed volume which complements the information in the first volume. This is the volume which fills in many of the details left out of the conceptual treatment in Volume 1. Here you'll find 19 detailed chapters on the engineering and logical specifications of products made by 16 different manufacturers, including in many cases reprints from the manufacturers' documentation as well as new materials provided by the author. Published in 1976, it even includes such processors as the MicroNOVA by Data General and the Texas Instruments TMS-9900 as well as the older 8 and 16 bit machines. Organization is by design type, and where parts of several manufacturers were intended for a given processor design such as the 8080, these are grouped into a single chapter. \$12.50

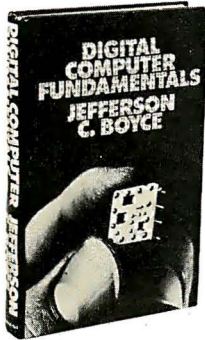

— **Digital Computer Fundamentals** by Jefferson C. Boyce. The way to a world of learning is through books. A great place to start, and to return from time to time, is the classical textbook. This new book from Prentice Hall is intended as just that. Topics covered include digital computer operation, basic computer circuits and concepts, Boolean algebra, implementing computer operations in hardware, communicating with the computer and related issues of coding schemes, detailed discussions of the control section, memory functions, arithmetic and logic functions, input and output functions of a classical computer, a chapter on computer programming and a final summary chapter on the details of a typical minicomputer design interpreted in the light of the more theoretical general concepts in the book. This book is excellent background information for the literate and well read hacker. Order yours today. \$15.95 hardbound.

— **How to Buy and Use Minicomputers and Microcomputers** by William Barden. People have often asked us where to turn to get an introductory book about computers for personal use. One excellent place to start is **How to Buy and Use Minicomputers and Microcomputers**, William Barden Jr.'s instant summary of the small computer revolution, published by Howard Sams in mid-1976. This is one of the first books of the "general introduction to computers" genre to be published with an emphasis towards the small computer and personal computing as it is being practiced these days. The book, written for the novice as well as the expert, surveys the technical details of the field in nine chapters and 10 appendices. This book is light (but essential) reading for the experienced computer person, and worthy of serious, concentrated perusal by the novice. \$9.95.

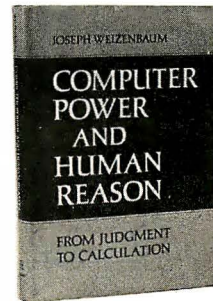

— **Computer Power And Human Reason** by Joseph Weizenbaum. This book is one which should be purchased or read for several reasons. If you're presently a programmer by trade or skill, you'll see a philosophy of computer use and abuse propounded. It's genuinely interesting, and definitely provocative if you reference the storm of letters, counter letters and counter counter letters which this book produced in the Association for Computing Machinery's *SIGART* newsletters during 1976. If you're a novice to the field, the tutorial and explanatory chapters of this book, which are aimed at the layman, will serve as an excellent background source which is also eminently readable. This includes an excellent and low level explanation of what an algorithm is, and how computers go about executing effective algorithms. \$5.95 softbound.

Send to:

BITS, Inc
70 Main St
Peterborough NH 03458

Total for all books checked \$ _____
Postage, 25 cents per book for _____ books \$ _____
Grand Total \$ _____

Check payment method:



___ My check is enclosed
___ Bill my MC No. _____ Exp. date _____
___ Bill my BAC No. _____ Exp. date _____

Name _____
Address _____
City _____ State _____ Zip _____
Signature _____

You may photocopy this page if you wish to leave your BYTE intact. Please allow six weeks for delivery.

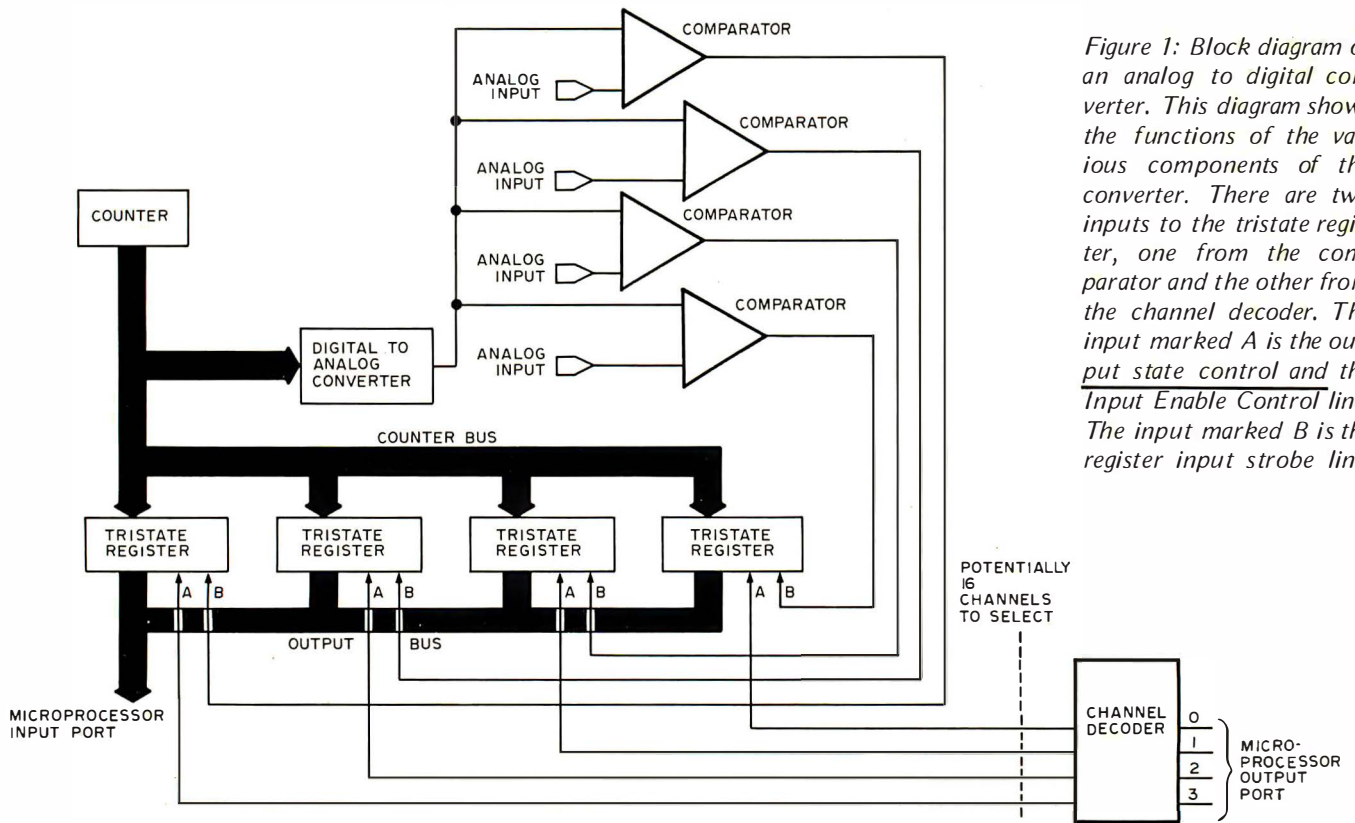

Figure 1: Block diagram of an analog to digital converter. This diagram shows the functions of the various components of the converter. There are two inputs to the tristate register, one from the comparator and the other from the channel decoder. The input marked A is the output state control and the Input Enable Control line. The input marked B is the register input strobe line.

An Inexpensive Joystick Interface

Thomas R Buschbach
12310 Purcell Rd
Manassas VA 22110

In the quest to develop the ultimate in video games, the need arose to interface analog controls to a microprocessor. A common control used in most video games is the joystick. It allows you to control two axes with one device. A joystick usually has potentiometers mounted on two adjacent sides as shown in photo 1. The potentiometers vary their resistance from 0 ohms to

their maximum value as the control stick is moved. The change in resistance is proportional to the displacement along the axis parallel to the surface the potentiometer is mounted on. All that remains is to convert these resistance values into digital values which the microprocessor can manipulate. To develop a full range of two and four player games, I decided four joysticks would be required. To interface four joysticks to the microprocessor would require eight channels of analog to digital conversion. Since the commercial analog to digital converters cost approximately \$50, buying eight of them was prohibitively expensive. Even buying only one and multiplexing its inputs and outputs seemed to be more expensive than necessary.

Being a typical software fanatic, I had no desire to build my own analog to digital (AD) converter. However, after examining all the alternatives, I decided to build Roger Frank's circuit (BYTE, May 1976, page 70),

Listing 1: This 8080 op code will read the digital value for the desired analog to digital channel. The digital value is left in the accumulator. All numbers in this listing and listing 2 are in octal.

octal address	octal code	op	operand	commentary
000	076 XXX	MVI	A,XXX	A:= number of desired channel;
003	323 AAA	OUT	AAA	output channel to unit AAA
005	333 BBB	IN	BBB	read digital value of channel from BBB
007	365	PUSH	PSW	save digital value;
010	227	SUB	A	clear accumulator and flags;
011	323 AAA	OUT	AAA	clear output port to 0;
013	361	POP	PSW	restore saved value;

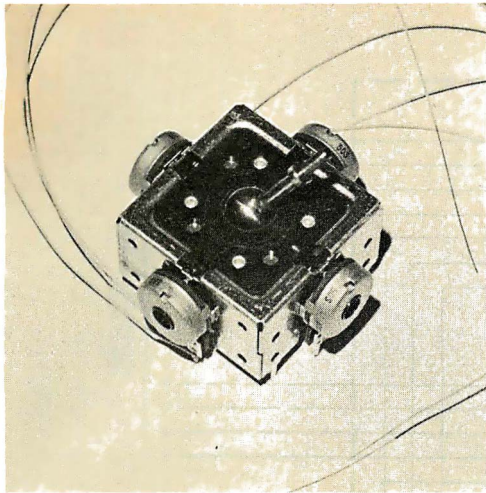

Photo 1: This is a typical joystick showing the potentiometers that are mounted on each side of the device and wired in parallel.

which utilizes a digital to analog converter (DAC) and a software algorithm to do the analog to digital conversion. After ordering the required components I decided that using a software algorithm to do the conversion for eight channels of analog to digital conversion would not leave the processor time to process the game's algorithm. At this point I decided to implement the software conversion algorithm in hardware.

In developing the circuit I had four design goals in mind:

Interface at least four joysticks, eight channels analog to digital.

Use no more than one input and one output port.

Use no processor cycles for the conversion process.

Sample each analog signal at least 1000 times per second.

A block diagram of the circuit is shown in figure 1. The detailed functions of the digital to analog converter and the comparators are explained in Roger Frank's article mentioned earlier. If you are considering constructing this circuit, I would recommend reading that article.

The circuit is controlled by a counter which continually counts down from octal 377 to 0, driving the inputs of a digital to analog converter. The output of the converter is compared to the analog input signal from the joystick. As long as the converter output voltage is higher than the

THE COMPUTER ROOM

SMALL COMPUTER SYSTEMS • SOFTWARE • AMATEUR RADIO EQUIPMENT

1455-A So. 1100 E. Salt Lake City, Utah 84105 Phone: 801-466-7911

"WE TAKE THE
MYSTERY OUT OF THE **MICRO**"



One Of The Nations Largest
Full-Service Computer Stores.

Over 1600 Square Feet Of Sales
And Service Facilities.

WHEN YOU WRITE FOR OUR CATALOG AND ENCLOSE \$1 TO HELP DEFRAY THE COST OF HANDLING AND MAILING, HERE'S WHAT YOU GET:

1. A CERTIFICATE GOOD FOR \$2 ON YOUR NEXT PURCHASE
2. THE **COMPUTER ROOM** EASY TO UNDERSTAND CATALOG COVERING

IMSAI
THE DIGITAL GROUP
POLYMORPHIC SYSTEMS
SOUTHWEST TECHNICAL PRODUCTS CORPORATION
TECHNICAL DESIGN LABS

ETC.

3. THE **COMPUTER ROOM** "EASY GUIDE" TO HELP YOU PICK THE RIGHT SYSTEM, PERIPHERALS, COMPONENTS, AND SOFTWARE FOR

THE BEGINNER
THE ADVANCED
THE EXPERT
THE SMALL BUSINESS

4. A CURRENT LISTING OF PRESENTLY AVAILABLE

SOFTWARE
PUBLICATIONS
PERIPHERALS

5. INFORMATION ON REPAIR SERVICE, LOW COST CUSTOM PROGRAMMING AND OTHER SPECIAL SERVICES.

AT THE **COMPUTER ROOM** YOUR WRITTEN QUESTIONS ARE HAPPILY RECEIVED AND PROMPTLY ANSWERED

WE ALSO STOCK A COMPLETE
LINE OF AMATEUR RADIO EQUIPMENT

BANKAMERICARD MASTERCHARGE

New and Used Electronic Surplus

- CRT Terminals
- Peripherals
- Electronic Assemblies
- Components

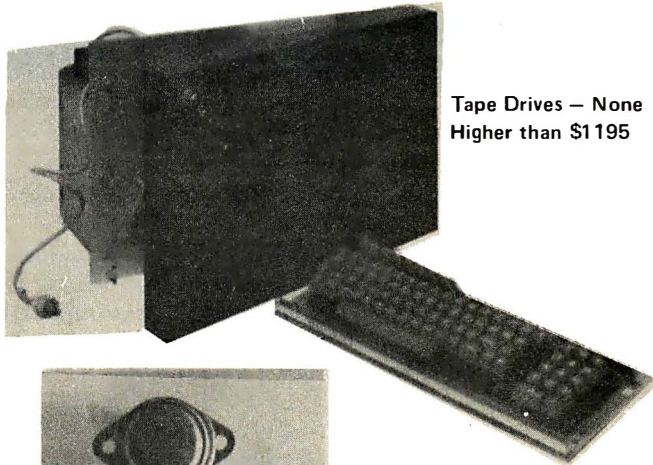

Tape Drives – None
Higher than \$1195

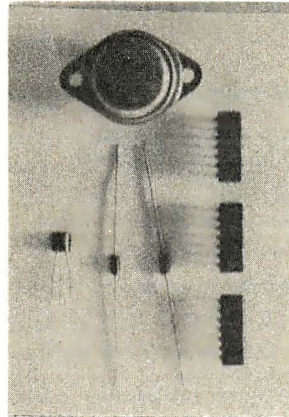

Keyboards

- Components – Power
Transistors, Diodes, Resistors, Capacitors
Integrated Circuits – from
10 Cents
Equipment Cabinets
Transformers

voltage from the joystick, the output of the comparator is 0. When the counter has counted down to a value which causes the converter to output a voltage equal to, or slightly below, the voltage from the joystick, the comparator output goes high. This edge triggers the corresponding tristate register to load the current value of the counters. This occurs asynchronously for each channel.

To access the digital value for the desired channel, you output a number from 1 to 8, corresponding to the desired channel, on an output port. Leaving this value latched in the output port, the digital value may be read from the desired input port. Clearing the output port to 0 completes the operation. This operation is shown in listing 1.

Figure 2 is the schematic to interface one joystick to the microprocessor. The circuit may easily be expanded to handle four joysticks. The 74123, IC1, is used as a multivibrator to generate a pulse waveform. With the resistance and capacitance values shown it will have a frequency of approximately 0.3 MHz. This pulse train drives the count down input of the 74193 counters IC2 and IC3 which form an eight bit binary counter which continually counts from octal 377 (or hexadecimal FF) to 0. The outputs of counters IC2 and IC3 are tied to each tristate register pair (IC5 and IC6, and IC7 and IC8) and to the digital to analog converter, IC4. This latter circuit produces a negative ramp continually going from +5 V to 0 V in 256 steps. The output of IC4 is converted from a current to a voltage signal by IC9. One quarter of IC10 is used to compare the output of IC9 to the voltage from the joystick. The output of each quarter of IC10 is tied to a single tristate register pair. This output remains a logical 0 as long as the voltage from IC9 is greater than the voltage from the joystick. When the voltages are equal the output of the corresponding quarter of IC10 shifts to a 1. This edge triggers the corresponding pair of registers to latch the value of the counters at

Table 1: Power connection table for the circuit of figure 2.

Number	Type	+5 V	GND	-12 V	+12 V
IC1	74123	16	8		
IC2	74193	16	8		
IC3	74193	16	8		
IC4	MC1408L-8	13	2		
IC5	74173	16	8		
IC6	74173	16	8		
IC7	74173	16	8		
IC8	74173	16	8		
IC9	LM301			4	7
IC10	LM339		12		3
IC11	7442	16	8		
IC12	7404	14	7		

Send for a free catalog or
Call toll free 800 258-1036
in NH 603 885-3705
Come to our Showroom

VOLUME AND INSTITUTIONAL DISCOUNTS AVAILABLE

WORLDWIDE ELECTRONICS INC.

10 Flagstone Drive, Hudson, New Hampshire 03051
Send my free catalog to

NAME: _____

ADDRESS: _____

I'm especially interested in:

- | | |
|--------------------------------|--------------------------------------|
| <input type="checkbox"/> NEW | <input type="checkbox"/> TERMINALS |
| <input type="checkbox"/> USED | <input type="checkbox"/> PERIPHERALS |
| <input type="checkbox"/> AS IS | <input type="checkbox"/> COMPONENTS |
| | <input type="checkbox"/> ASSEMBLIES |

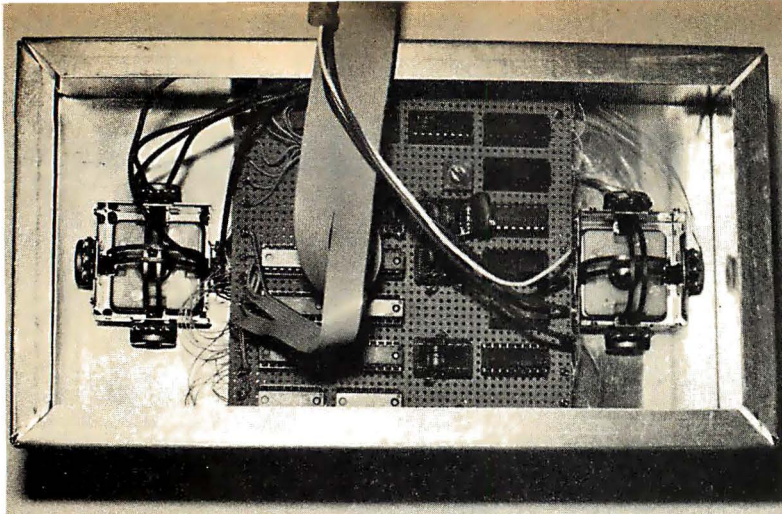

Photo 2: Underside of finished assembly showing wire wrap board and two joysticks.

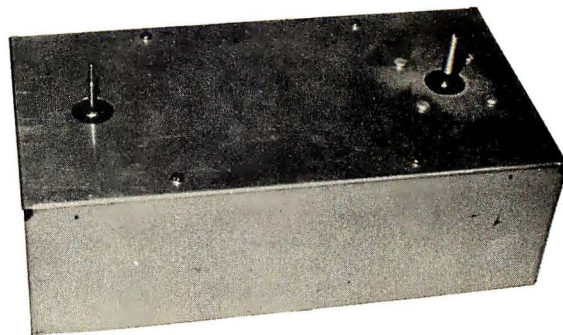

Photo 3: This is the top view of the finished unit showing the two control sticks; the connectors are for input port, output port and power. An identical box with two more joysticks will plug into the side of this box for games requiring four joysticks.

Listing 2: This subroutine will read the digital value from a requested analog to digital conversion channel, set minimum and maximum values, apply a scaling factor, add or subtract an offset value, and then return the resulting value in the accumulator to the calling program. The program can be located at any high order address, symbolized by <x> in the listing.

octal address	octal code	label	op	operands	commentary
000	176		MOV	A,M	A:= channel number;
001	323 002		OUT	2	output channel number;
003	333 002		IN	2	input digital value;
005	043		INX	H	HL:=HL+1;
006	107		MOV	B,A	B:=digital value;
007	227		SUB	A	} clear output port;
010	323 002		OUT	2	
012	176		MOV	A,M	A:=minimum value;
013	270		CMP	B	} if B>A then go to JP1 [not lower limit] ;
014	332 020 <x>		JC	JP1	
017	107		MOV	B,A	else B:=A [set lower limit] ;
020	043	JP1	INX	H	HL:=HL+1;
021	176		MOV	A,M	A:=maximum value;
022	270		CMP	B	} if B<=A then go to JP2 [not upper limit] ;
023	322 027 <x>		JNC	JP2	
026	107		MOV	B,A	else B:=A [set upper limit] ;
027	043	JP2	INX	H	HL:=HL+1;
030	227		SUB	A	clear accumulator and flags;
031	206		ADD	M	A:=A+scale factor;
032	372 054 <x>		JM	JP3	if scale factor negative then go to JP3;
035	312 070 <x>		JZ	JP4	if scale factor zero then go to JP4;
040	127		MOV	D,A	D:=A;
041	170		MOV	A,B	A:=B;
042	027	JP5	RAL		shift left;
043	067		STC		} clear carry;
044	077		CMC		
045	025		DCR	D	D:=D-1;
046	302 042 <x>		JNZ	JP5	if D≠0 go to JP5;
051	303 067 <x>		JMP	JP6	go to JP6;
054	346 177	JP3	ANI	177	mask most significant bit;
056	127		MOV	D,A	D:=A;
057	170		MOV	A,B	A:=B;
060	037	JP7	RAR		shift right;
061	067		STC		} clear carry;
062	077		CMC		
063	025		DCR	D	D:=D-1;
064	302 060 <x>		JNZ	JP7	if D is greater than 0 go to JP7;
067	107	JP6	MOV	B,A	B:=A;
070	043	JP4	INX	H	HL:=HL+1;
071	227		SUB	A	clear accumulator and flags;
072	206		ADD	M	A:=offset value;
073	372 100 <x>		JM	JP8	if most significant bit =1 then go to JP8;
076	200		ADD	B	A:=A+B;
077	311		RET		return;
100	346 177	JP8	ANI	177	mask most significant bit;
102	127		MOV	D,A	D:=A;
103	170		MOV	A,B	A:=B;
104	222		SUB	D	A:=A-D;
105	311		RET		return;

that instant. All tristate register outputs are normally in the high impedance state. To access a register you output the number of the desired channel on an output port. The 7442, IC11, decodes the four least significant bits of the output port to determine which register pair to enable the outputs on; at the same time disabling the inputs of the register pair so that the registers will not be updated while the microprocessor is accessing them. A 0 on the output port places all tristate register outputs in the high impedance state.

Construction Notes

Resistor R4 is used to set the maximum digital value possible. Set all data inputs to the digital to analog converter at +5 V, then set R4 to yield the desired digital value. This sets all analog to digital converter channels simultaneously. If it is required to adjust a single channel's maximum value then a resistor must be added in series with the joystick, such as R15. A value equal to the joystick's internal resistor would cut the full scale digital value in half. Note that the maximum value may also be limited by software as is done in listing 2, but this does not utilize the full displacement of the joystick, as using R15 would.

The +5 V at the joysticks must be regulated and free from noise. Any fluctuations in this voltage will cause fluctuations in the digital value. Depending on your power supply and wiring, it may be necessary to provide a zener diode for on board regulation of the +5 V supply. Also, be sure to use several bypass capacitors.

Software Control

The subroutine of listing 2 will read the digital value from the requested analog to digital conversion channel, set minimum and maximum values, apply a scaling factor, add

or subtract an offset value, and then return the resulting value in the accumulator to the calling program.

A control block must be set up for each analog to digital channel. The address of the control block must be loaded into the HL register pair prior to calling the subroutine. The control block of 5 bytes must be in the following format:

Starting address	Channel number
+1 byte	Minimum value
+2 bytes	Maximum value
+3 bytes	Scale factor
+4 bytes	Offset value

The first byte, channel number, selects the desired pair of tristate registers. It is the binary coded decimal number which when output to the analog to digital converter unit will cause IC11 to enable the desired register pair.

The second byte, minimum value, determines the absolute minimum number that is accepted from the converter. If the value from the converter is smaller than the minimum value it is set equal to the minimum value.

The third byte, maximum value, determines the absolute maximum number that is accepted from the converter. If the value from the converter is larger than the maximum value it is set equal to the maximum value.

The fourth byte, scale factor, determines by what power of two the raw digital data will be scaled. Scaling is accomplished by the new value set equal to the raw data times 2 raised to the power of the scale factor where the scale factor is any value from -127 to +127. This yields the following possible factors (. . . 8, 4, 2, 1, .5, .25, .125, . . .). A one in the most significant bit signifies a negative scale factor.

The fifth byte, offset value, is added to the digital value after the scale factor is applied. It may be any number from -127 to +127. As a two's complement integer, a one in the most significant bit signifies a negative offset.

Conclusions

The final assembly of this circuit, shown in photos 2 and 3, was built into an aluminum housing on a wire wrap board. The circuit can be used to interface any analog voltage signal to a microprocessor. The circuit for interfacing two joysticks to the microprocessor was constructed for about \$35, exclusive of the cost of the joysticks. For an additional \$10 the circuit could be increased to handle four joysticks. ■

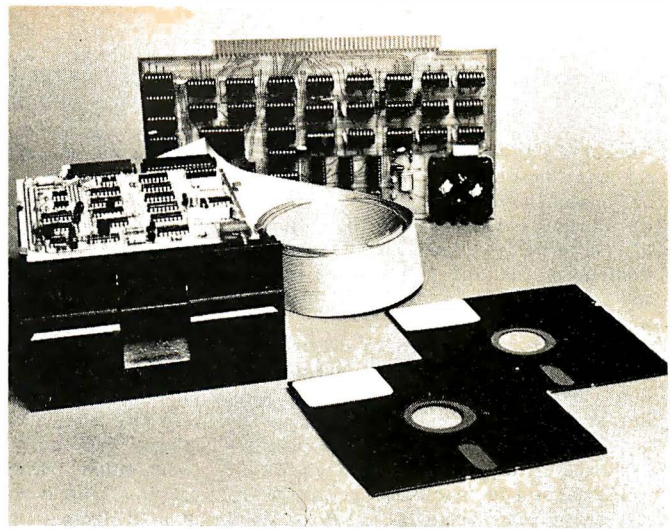

COMPLETE FLOPPY DISK SYSTEM FOR YOUR ALTAIR/IMSAI \$699

That's right, complete.

The North Star MICRO-DISK SYSTEM™ uses the Shugart minifloppy™ disk drive. The controller is an S-100 compatible PC board with on-board PROM for bootstrap load. It can control up to three drives, either with or without interrupts. No DMA is required.

No system is complete without software: we provide the PROM bootstrap, a file-oriented disk operating system (2k bytes), and our powerful extended BASIC with sequential and random disk file accessing (10k bytes).

Each 5" diameter diskette has 90k data byte capacity. BASIC loads in less than 2 seconds. The drive itself can be mounted **inside** your computer, and use your **existing** power supply (.9 amp at 5V and 1.6 amp at 12V max). Or, if you prefer, we offer a power supply (\$39) and enclosure (\$39).

Sound unbelievable? See the North Star MICRO-DISK SYSTEM at your local computer store. For a high-performance BASIC computing system, all you need is an 8080 or Z80 computer, 16k of memory, a terminal, and the North Star MICRO-DISK SYSTEM. For additional performance, obtain up to a factor of ten increase in BASIC execution speed by also ordering the North Star hardware Floating Point Board (FPB-A). Use of the FPB-A also saves about 1k of memory by eliminating software arithmetic routines.

Included: North Star controller kit (highest quality PC board and components, sockets for all IC's, and power regulation for one drive), SA-400 drive (assembled and tested), cabling and connectors, 2 diskettes (one containing file DOS and BASIC), complete hardware and software documentation, and U.S. shipping.

MICRO-DISK SYSTEM . . . \$699
 (ASSEMBLED) \$799
 ADDITIONAL DRIVES . . . \$425 ea.
 DISKETTES \$4.50 ea.
 FPB-A \$359
 (ASSEMBLED) \$499

To place order, send check, money order or BA or MC card # with exp. date and signature. Uncertified checks require 6 weeks processing. Calif. residents add sales tax.

NORTH STAR COMPUTERS, INC.
 2465 Fourth Street
 Berkeley, CA 94710

Popular Electronics Cosmac ELF project, has a possibility of expansion without too much complexity. The processor was obviously designed with the notion that software is cheaper than hardware (sometimes) and the 1802 can be programmed to replace hardware in many ways.

One such way is using a programmable output line as a memory extension address bit. The processor has a Q line output which can be programmed in software to be either high or low. This could be used (properly buffered of course) as an address bit to select a page of memory. This would allow expansion of its address to 17 bits very simply and allow 128 K with very little hardware and also very little software.

I don't intend to be even in the 64 K range for quite some time but those who could use 128 K now can get it easily. Thanks also for the "Beer Budget Graphics" article in the November issue, page 26.

John Pawlicki
6065 Greenwycke Ln
Monroe MI 48161

The same general technique is what is meant by adding bank selection logic to a machine. Several processors have similar opportunities for expansion. For example, the National Semiconductor PACE 16 bit processor has 4 programmable flag outputs - treating those flags as address bits externally results in a total of 20 bits worth of memory address space, or a maximum of 1,048,576 words of memory.

ARE ANY READERS USERS OF SURPLUS DATAPoint MACHINES?

I've been reading BYTE since the August 76 issue and have enjoyed it quite a lot. It is nice to know there are so many computer freaks out there. The reason I'm writing is that I used to work for Datapoint Corp as a technician. I had a Datapoint 2200 Version II to use for test purposes. It is an 8 bit TTL mini-computer and is fairly fast and powerful. It has a built-in 80 character by 12 line CRT display, a keyboard and a dual cassette deck. Although it has only 16 K of programmable memory, I found it more than adequate with the 2 cassettes with 110 K each, and disk operating software is available. There is a large amount of high level software (including timesharing) available including several excellent diagnostic programs (capable of identifying which memory chip is bad, for example).

They have made over 5,000 of these minis since 1973 and they are available in the used market. I have read of amateur use of the PDP-8, but there has been no mention of the Datapoint. Is there anyone else out there interested in this mini?

Bill Doyle

The solution to "Bug of the Month #4," in October 76 BYTE, page 41, overlooks an important point. I think it is logically correct after handling the N=2 case and moving statement K=1 to precede the last RETURN as suggested. However, the program (or any program) does not run in a clean environment. Any computer that a FORTRAN compiler or interpreter runs on has a limited integer range. If the value of N to be tested is prime and near the maximum integer that can be represented, the computation I*I will result in integer overflow. This is particularly a problem in FORTRAN as some versions do not give error indications on integer overflow.

As an example, I checked this problem using a version of WATFIV on an IBM 370. Integer overflows do not give an error. The maximum positive integer is 2,147,483,647 (2**31 - 1). In the program the value of I is increased until I*I is greater than N, assuming N is prime. The largest value of I which will not overflow when squared is SQRT (2147483647) truncated or 46340. Any prime numbers larger than 46340**2 (2,147,395,600), but still within the integer range, will cause an integer overflow of I and improper termination. I consulted a prime number table and found they don't generally go up to 2 billion; however, there are probably plenty of prime numbers in this category.

Even in the case that an error message occurred on overflow, the routine is still not working correctly. While it would not result in potentially erroneous results, neither has an answer been returned to a perfectly reasonable request. For these large values of N, a possible solution is to simply check for the value of I exceeding 46340 following the I increment. If this occurs, N is then prime.

Unfortunately, this requires an extra operation in the loop and depends upon the computer's integer range. I have not been able to think of a better method.

Keep up the good work. "Bug of the Month" is usually interesting.

Richard Altmaier
POB 2061
Stanford CA 94305

CORRECTIONS FROM BOB MARSH

Three factual errors were included in recent issues of BYTE magazine regarding Processor Technology products:

1. Our Software No. 1 Resident Assembler, Editor Monitor package (referred to in the article as "SYS 8") was a joint development effort between Microtec and Processor Technology. Employees of PTC added many neat features to the original Microtec program in order to produce Software Package No. 1. It was first distributed

in July or August of 1975 in the form of well documented source listings. Paper tapes were distributed to many computer clubs free of charge.

Other companies, including IMSAI and Tarbell, have since made use of Software No. 1 adding minor modifications to suit their IO device requirements. To my knowledge at least six other firms have reproduced Software No. 1 in one form or another, all of them giving PTC and Microtec credit for authorship. (All, that is, except one rather well known "surplus" dealer.) Please note that Microtec receives a small but well deserved royalty on each Software No. 1 we distribute. No other manufacturers are paying such royalties.

Software No. 1 is currently available from Processor Technology for \$14.50 including both source listing and hexadecimal object paper tape or CUTS/BYTE standard cassette.

2. A recent review of our VDM-1 Video Display Module stated delivery as 60 days. In fact VDM-1s have been available "off-the-shelf" since October of 1976. There is no excuse for any of our 40 or so retail distributors to be out of stock for more than a few days. With good planning they should always have VDM-1s, as well as our 2KRO, 3P+S, 4KRA and 8KRA modules, in stock.

3. In your review of the Sol computer system you added \$97 for our CUTS audio cassette data interface. The Sol has its own CUTS type interface built in and does not require an additional module for this function. (The CUTS board is primarily used in Altair and IMSAI mainframes.) So the system pricing in your example should be:

Sol-20 kit	\$ 995
SOLOS module	100
TV/monitor	150
Cassette recorder	100
8KRA	295
Software	48
	<hr/>
	\$1688

Bob Marsh
Vice President
Processor Technology
6200 Hollis St
Emeryville CA 94608

COMMENTS ON HOME COMPUTERS: FIND A NEED AND FILL IT

Find a need and fill it! Henry Kaiser built quite a business organization using that phrase as one of his business precepts. And now the development of microcomputers and microprocessors has created a market for home use.

There are many functions in the home that can be carried out by microcomputers because of their unique properties that could not be effectively performed before. They include financial information, inventory of assets, inventory of food and supplies, energy control, recreational games and surveil-

lance for theft and fire. You can probably think of more uses.

A whole new industry is being spawned and it does not detract from other industries because new needs are being created. It can create new job and career opportunities for persons familiar with computer usage.

What should be the marketing effort? Should it be structured like the auto industry with franchisee dealers and new models coming out every year or should it be structured like the radio and television industry with dealers carrying a multiplicity of models? Time will tell.

I would like to see demonstration models placed in places like Newport's Fashion Island or Glendale's Galleria or Los Angeles' Broadway Plaza.

W Donald Pollock
149 S Burlington Apt 2
Los Angeles CA 90057

WANTED: HIGH BANDWIDTH TV MODS

I see many articles and projects on converting televisions to video terminals for use on minis and micros. Unfortunately (for me), these are all set up to generate a 32 character line. I would like to build a terminal using a TV or video monitor that would have 80 or 72 characters per line. Isn't there a kit or some way of bypassing the front end of a TV that will let you get the bandwidth needed? And just how does one figure out the bandwidth that is needed? Does anyone out there have the schematics or logic diagrams for such an adventure? Any help is really welcome.

Joe Heck
12 Enfield St
Jamaica Plain MA 02130

Any authors out there engineering a commercial TV mod which fits this bill? Or is it even possible?

AUTHORS TAKE NOTE: 488 BUS INTERFACE WANTED

I have never written to a magazine, but as I have never enjoyed a publication as much as BYTE, I felt I just had to sit down and let you know how I feel.

I got into programming in a small way a few years ago, with the HP-65 and programming became a new love. I am the Electronics Section Supervisor of the Metrology Laboratory at Puget Sound Naval Shipyard. We have recently acquired an Altair 8800a with 20 K programmable memory, a TTY, 8 K and extended BASIC, and a 4P IO board with 4 ports. We are presently using the Altair for data processing and scientific calculations, but hope to use it in the future as an automatic instrumentation controller.

This brings up a point: I sure would like to see marketed or published a design for an interface from the Altair bus or standard 8 bit parallel ports to the IEEE 488-75 bus. The use of a micro-

What good is a Micro-Computer if you can't make it work?

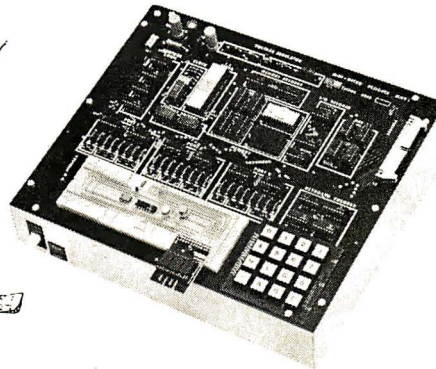

Startup time on micro-computers can be a real problem. We know that. That's why we've developed The Mini-Micro-Designer. The first complete package of hardware, software and educational materials. All with one purpose: to speed microprocessor system design.

How? By providing the only microprocessor test and development system with solderless breadboarding capabilities. At its heart: the 8080A processor chip, providing all signal functions. A

panel that monitors the address and data busses of the micro-processor and allows data I/O with or without an asynchronous terminal. And the Bugbook V, E&L's innovative approach to self-teaching micro-electronics.

So experiment. Design. Test. Because now there's a system that's caught up with imagination. The Mini-Micro-Designer from E&L Instruments. Available now at your local computer store. Suggested resale price \$422.50 (U.S.A.)



E&L INSTRUMENTS, INC.

61 First Street, Derby, Conn. 06418
(203) 735-8774 Telex No. 96 3536



computer and a terminal with this interface would give the calibration instrumentation industry an inexpensive and versatile automatic test system.

Bruce O Ferland

PS: Am very excited about machine readable, printed software (bar codes). Hope to see some hardware marketed in the near future.

FREEDOM OF ENTRY

Wilber and Fylstra's sneers at computer professionals in the article "Homebrewery versus the Software Priesthood," October BYTE #14, page 90, are both unnecessary and unsupported. To believe that the industry, its managers, or its programmers *encourages* the present high cost of designing and maintaining software is stupid. Manufacturers normally lose money on systems software that they must develop to sell their machines and want lower costs and greater flexibility reliability (how much does a new release of an operating system cost?) more than anyone. The wide acceptance of such new techniques as top down structured programming, proofs of program correctness, chief programmer teams, and relational file organization indicates the interests of the profession in improving clarity, reliability and productivity.

The demand for computers and programs is very elastic (total spending for these things increases as prices drop). I and other programmers have *more* work than we need. We are happy to have people learn programming.

For those who did not see the article, Wilber and Fylstra accused the profession:

1. of deliberately surrounding computers with an aura of mystery;
2. of protecting their privileged posi-

tions by keeping their knowledge to themselves;

3. of regarding their knowledge as sacred and beyond the non-specialist;
4. of being high priests and acolytes of the holy alliance of logic.

All of these charges are false.

In its growth and achievements, the computer industry has been the most dynamic enterprise in this country. We, the computer hobbyists, exist *because* of this success, not in spite of it. Both politically and psychologically, the computer industry is remarkably free of barriers to entry. I have no license or certificate. I have no college degree yet. I was able to get a position as a programmer analyst with no previous experience largely because of my experience in home computing.

Wilber and Fylstra are idiots. They get a minus infinity on BOMB from me.

The December 1976 BYTE was one of the best ever. Keep up the (usually) good work.

Martin Buchanan
2040 Lord Fairfax Rd
Vienna VA 22180

See Mike and Dave's comments in their letter replying to HT Gordon's comments in December. They apply equally here. Would anyone else care to comment?

IS THE SOFTWARE PRIESTHOOD CONCEPT CONSIDERED DANGEROUS?

In his letter concerning the evaluation of microprocessor instruction sets, December 1976 BYTE, page 50, HT Gordon misunderstood the main thrust of our article, "Homebrewery versus the Software Priesthood," October 1976 BYTE, page 90: Of course professional

software people *will* always be needed by business executives to help evaluate commercial products — that's not our point! We decry only those software people who, like some priests, seek to protect their knowledge of the programmer's art, as opposed to their product. We were concerned with the personal market, not the very different commercial market, and we fundamentally wish to encourage widespread software literacy and free exchange in this personal computing hobby.

Our recognition that there is room for journeyman programmers in the computer business should be clear from our discussion of their relation to the personal computing user. It is important, however, to carefully distinguish the two worlds. In the business world, the programmer's relationship to the client is typically that of an employee or a contractor. By contrast, the firm supplying software for personal use hopes to have a large number of individual customers. The salient distinction is of accountability: The parties to a software transaction are *much* more closely related in the first case than in the second. A commercial client can reasonably expect the software product to suit its intended application, but any individual user of commercially supplied "personal" software represents only a tiny portion of the supplier's intended market. Point one: Individuals wanting personal computers responsive to their own needs must be prepared to program the computer themselves.

On the other hand, if a lot of people know how to program their own computers, then somebody else stands to lose. That somebody else, though, hardly includes everyone paid to write computer programs. While people won't buy something they could easily do better themselves, they are generally happy to

CASSETTE OR FLOPPY DISK? - PERCOM GIVES YOU A CHOICE!

THE CASSETTE I/O THAT WORKS!

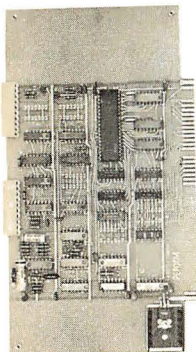

- Complete CASSETTE & TERMINAL I/O
- ALTAIR/IMSAI plug-in compatible SWTP 6800 and others available
- KANSAS CITY/BIPHASE Standard
- Self Clocking-immune to tape spd
- 30-240 bytes/sec Cassette I/O (fastest RELIABLE Cassette!)
- 300-9600 Baud Data Terminal I/O (RS-232 compatible!)
- Works with ANY cassette recorder (even at 120 and 240 bytes/sec)
- Load/Dump Software included
- Provision for remote control
- Run 2 Cassettes Simultaneously
- 25 Page Instruction Manual

\$89.95 KIT \$119.95 ASSEMBLED

Instruction Manual only \$4.00
(refunded with order)

THE NEW LI'L FLOPPY!

"now you can afford a floppy!"

- Compact 3½"x6"x9"
- Uses the compact disk drive and low cost 5¼" diskettes
- Stores 95.2K bytes/diskette
- Load 12K bytes in 2 seconds
- ALTAIR/IMSAI and SWTP 6800 Interfaces (specify w/o)
- Works with existing software
- BASIC ETC and other software available (extra cost)
- Price includes one disk drive enclosure, cables, interface 2 diskettes, driver software

\$695 KIT \$810 ASSEMBLED

Instruction Manual only \$10
(refunded with order)
Delivery is 60 days ARO

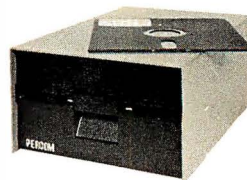

Dealer inquiries invited

PERCOM

Call or write for complete specifications

PERCOM DATA COMPANY • 4021 Windsor • Garland, Texas 75042 • (214) 276-1968

BANKAMERICARD

master charge

pay for quality merchandise. The essential factor here is the quality of the product. If individual users find it easy to produce fairly good programs, they'll only buy the really good stuff; the only losers will be the producers of mediocre goods. On the other hand, if ignorance is rampant, the less competent programmers can flourish in the personal market. Point two: Only the second rate practitioners stand to gain by a lack of wide scale diffusion of software skills.

Now, most hackers learned what they know for free, and they learned it through personal contact with other hackers. This has almost always happened where they were in close proximity. However, hobbyists, who currently represent almost the entire community of people making personal use of computers, are dispersed geographically. A good system of communication is necessary to bridge the distances. Telecommunications, with its very high transmission speed, can do wonders in helping people share consumerist views of the market as well as actual programs. The telephone brings personal telecommunication into a fantastically large proportion of people's homes, but it has the disadvantage of requiring both parties to a communication to be at home and disposed to communication at the same instant. That's why we proposed a network of "Community Information Exchanges" to serve as buffers to communication. Point three: A CIE net can be of immense utility in dispelling ignorance.

To close the circle, we had no intention to put anybody down; the ideas we're pushing are that a lot of people should learn to use computers well. That'll benefit all the good guys; and there's a plausible sounding mechanism by which we can pull it off. We disparage only those who, for whatever reasons, try to prevent it.

Mike Wilber
920 Dennis Dr
Palo Alto CA 94303

David Fylstra
POB 10051
Stanford CA 94305

One point of information, which was not available to Mike or Dave, or Martin or H T Gordon at the time of writing of their respective letters: The results of a recent survey of a random sample of BYTE's 2100 readers out of our list show that they tend to be people with some experience in software with the following numbers:

- 51% indicated prior experience with any large computer system.
- 58% indicated prior experience with a minicomputer.
- 79% indicated that they intend to use (52%), or are using (27%), their personal computer system for software development.

The numbers for various specific professional and business applications goals

such as text editing, accounting, or simulation were typically 30% in the "intend" category with 5 to 10% indicating the "actually using" category.

This tends to indicate a significant overlap between professional people and personal computing users so the issue may be a moot one.

WHAT'S AN APPLE?

I am thinking about purchasing an Apple II minicomputer, but before I purchase it I would like to get as much information as possible about it. I wondered if you have heard about this computer or if you had written a product description about it in a past issue. If you could send me any information on it, I would appreciate it very much.

Andrew McNelly
1176 Berkshire Dr
San Jose CA 95125

I saw the prototype in operation on Saturday November 20 1976 in Palo Alto CA in my hotel room when Steve Jobs and Steve Wozniak, Apple's creators, demonstrated it. It will be an excellent product, completely preassembled, available at computer stores nationally as well as by mail order. A 6502, 6 K ROM BASIC, color graphics, completely

assembled case and keyboard, 4 K program memory, audio interface, monitor program, etc, all for about \$1300. Go to a Homebrew Computer Club meeting and ask people about it. . . CH

HIGH LEVEL DECODING PROBLEM?

Thank you!

As an owner of the SR-52 (and printer), I was delighted to see your articles in the December issue. Programmable calculators, such as the SR-52 and HP-95/97, represent very powerful tools when one must deal with number systems.

I've just about finished a mini Star Trek game. Each time you get a Klingon, the display flashes "BLOOIE" (310078, upside down).

I hope you continue to set aside a small portion of your magazine for these hand held computers.

Meanwhile, my Motorola 6800 evaluation board is waiting in the wings for an RS-232 peripheral.

Tom Handley
New Age Communications
Portland OR

PS: You can reprint this letter if you can decode my terrible writing. (No software provided!) ■

If you want a microcomputer with all of these standard features...

- 8080 MPU (The one with growing software support)
- 1024 Byte ROM (With maximum capacity of 4K Bytes)
- 1024 Byte RAM (With maximum capacity of 2K Bytes)
- TTY Serial I/O
- EIA Serial I/O
- 3 parallel I/O's
- ASCII/Baudot terminal compatibility with TTY machines or video units
- Monitor having load, dump, display, insert and go functions

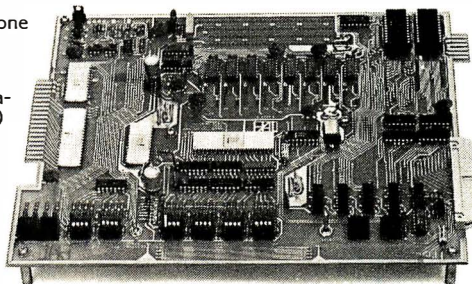

- Complete with card connectors
- Comprehensive User's Manual, plus Intel 8080 User's Manual
- Completely factory assembled and tested—not a kit
- Optional accessories: Keyboard/video display, audio cassette modem

interface, power supply, ROM programmer and attractive cabinetry... plus more options to follow. **The HAL MCEM-8080. \$375**

...then let us send you our card.

HAL Communications Corp. has been a leader in digital communications for over half a decade. The MCEM-8080 microcomputer shows just how far this leadership has taken us...and how far it can take you in your applications. That's why we'd like to send you our card—one PC board that we feel is the best-valued, most complete



microcomputer you can buy. For details on the MCEM-8080, write today. We'll also include comprehensive information on the HAL DS-3000 KSR microprocessor-based terminal, the terminal that gives you multi-code compatibility, flexibility for future changes, editing, and a convenient, large video display format.

HAL Communications Corp.
Box 365, 807 E. Green Street, Urbana, Illinois 61801
Telephone (217) 367-7373

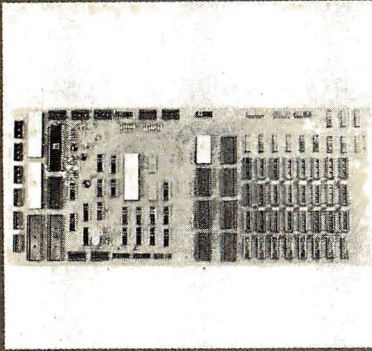

Microprocessor Quay 80MPS. For serious hobbyists.

Quay 80MPS is not designed for the casual hobbyist. Only if you're serious about your personal computing, should you find out about Quay 80MPS's features, capabilities, and options. Only if you want to break free from hobby-class microprocessors and enter a great new world of sophisticated computing experiences, should you get into the Quay 80MPS.

Features

- Single PC board. 16 pin dip connectors (no costly backplane or edge connectors.)
- Z-80 CPU, 158 instructions, 2.5 MHz clock.
- 4K dynamic RAM. Expands to 16K on board (Z-80 refreshes w/o loss of thru-put).
- 1K UVEPROM monitor. Inspect, alter, dump, and load memory; set breakpoints; trace and single-step debugging; handles serial I/O.
- 7 additional UVEPROM sockets.
- 4 8-bit parallel I/O ports. Vectored interrupt (2 Z-80 PIO's, expands to 4).
- 1 socket for Z-80 4 channel counter timer.
- 1 UART, RS232 & 20 ma interface.
- UVEPROM programmer (2708).
- Fully buffered address, data and control.

Quay 80MPS is \$695, assembled and tested. Send for complete details. Or for fast action, Call 201-681-8700.

Mastercharge and BankAmericard accepted. COD with 1/3 deposit. N.J. residents add 5% sales tax. Price does not include shipping and handling.

Dealer inquiries invited.



P.O. Box 386, Freehold, N.J. 07728.
Phone: 201-681-8700

What's New?

At Last! A Phi Deck Tape Mass Storage System for the Altair Bus

Recognizing the need for low cost versatile mass storage for the Altair and compatible 8080 based microcomputers, Micro Designs is offering two new digital cassette mass storage systems with up to one megabyte capacity.

According to the manufacturer, an integral part of these ready to use systems is a complete system of file management software which allows the user to manipulate both symbolic and binary files with high level commands.

The Micro Designs Model 100 is a compact single cassette drive which stores up to one half megabyte of data. The random access format of the data on



the tape allows programmed access to any single 128 byte record. The data transfer rate is 1000 bytes per second, and the tape may be searched at a rate exceeding 120 inches per second. The dual transport Model 200 puts up to one megabyte of peripheral files on line.

Both units come fully assembled, and ready for immediate use. The interface board plugs into the main frame motherboard connector to attach the mass storage unit to the computer. To bring up the operating system, the user loads a cassette, and transfers control to the ROM on the interface board; all further tape operations are automatic. Status lights inform the user of relevant tape conditions, and hardware error detection is provided. These small table top units sell for \$550 (Model 100) and \$825 (Model 200). Delivery is quoted as 30 days after receipt of order. Contact Micro Designs Inc, 1175 Colusa Av Berkeley CA 94707. ■

At Issue, a Table

We received the following item concerning a new products item in the December 1976 BYTE.

I wish to take issue with the comparison chart given in the "State of the Art Disk Technology" on the SA-400 Mini-floppy. Specifically, the specifications on the 3M Minicartridge. When used with the Qantex Model 200 MINIDRIVETM, the 3M Minicartridge has an unformatted capacity of 336 kilobytes. With the high density option, the Model 200 will provide 676 kilobytes on one 3M Minicartridge. These numbers are computed as follows:

$$\begin{aligned} \text{Capacity per track (unformatted)} \\ &= \text{Length of tape (feet)} \cdot 12 \text{ inches} \\ &\quad \text{per foot} \cdot \frac{\text{Packing density (bpi)}}{8 \text{ bits per byte}} \\ &= 140 \cdot 12 \cdot \frac{800}{8} \\ &= 168 \text{ K} \end{aligned}$$

For two tracks

$$\text{Capacity} = 336 \text{ kilobytes}$$

Thus, your figure of 100 kilobytes is completely erroneous.

The Qantex Model 200 is offered with either a 1 or 2 track head.

Next, let's consider transfer rate, which is computed as follows:

$$\text{Transfer rate} = \text{tape speed (inches/seconds)} \cdot \text{packing density (bits/inch)}$$

$$\begin{aligned} \text{Transfer rate} &= 30 \text{ ips} \cdot 800 \text{ bpi} \\ \text{Transfer rate} &= 24 \text{ kilobits per second} \end{aligned}$$

Thus, an order of magnitude error in your chart. The Qantex Model 200 with the high density option provides a transfer rate of 48 kilobits per second.

Average access time is usually computed as one half the time required to traverse the media. The Qantex Model 200 provides a high speed mode wherein tape is moved at 90 ips. Access time is computed as follows:

$$\begin{aligned} \text{Access Time} &= \frac{\text{Tape length (ft)} \cdot 12 \text{ in/ft}}{2 \cdot \text{Tape speed (in/sec)}} \\ \text{Access Time} &= \frac{140 \cdot 12}{2 \cdot 90} \\ \text{Access Time} &= 9.34 \text{ sec.} \end{aligned}$$

The Qantex Model 200 MINIDRIVETM with intimate electronics is significantly smaller than indicated, with a physical size of 4 by 4.125 by 3 inches with a companion PC card of 4.5 by 6.5 inches. When packaged in an optional sheet metal enclosure, the complete drive including all PC cards is 4.75 by 4.75 by 7.5 inches.

Incidentally, the Qantex Model 200 configuration, which is equivalent to the type supplied by the SA-400, also costs \$390, quantity one.

All things considered, I believe the decision to use a cartridge or disk must be founded upon careful analysis of system requirements. If access time is of key importance, the disk is the obvious choice. If capacity is of key importance, then the cartridge is the obvious choice. Other considerations might be the length of time it takes to validate a data block

just recorded. The rotational latency for the disk is 200 ms. Thus, the system has to wait 200 ms to validate a block just recorded. The Qantex Model 200 with a dual gap head will provide verification 5 ms after the last bit has been recorded. For many applications, this is a critical parameter.

Also to be considered is the MTBF of the two devices. The Model 200 MINI-DRIVE™ has only one motor as opposed to two for the floppy. Aside from the one motor, there is virtually no other mechanism for the Minidrive. The floppy, on the other hand, has the indexing mechanics to impart linear motion to the head positioning mechanism. Shugart's method for indexing is very clever; however, it does not appear to be able to operate in an environment of moderate shock and vibration. Qantex experience in producing the "standard" 3M Cartridge peripheral (AN/USH-26(V) for the Naval Electronics Systems has resulted in a cartridge drive which can operate in severe environments.

Joel A Kramer
President
Qantex Division
North Atlantic Industries Inc
200 Terminal Dr
Plainview NY 11803

Moral of the Story:

When putting in a new product item, the information is supplied by the producer of the product. Now, here is an oblique way of providing a new product item on the Qantex Model 200 MINI-DRIVE—in the way of an interesting letter of protest over a table found in December BYTE. As noted in the Shugart feature in December, the information, in the table on page 87, was "supplied by Shugart." A note of qualification concerning the Philips cassette drive was placed in the text because of the availability of the Phi-Deck and similar low cost drives.

Manufacturing and marketing a product, any product, whether it be a computer, or one's personal services, is a very personal and people oriented activity. Products don't spring forth by magic but represent the creativity of the people working on their design and marketing. This letter emphasizes that fact... CH ■

Where to Go to Get Whatever . . .

The following text is taken essentially verbatim from a well written press release. . .

A new directory has just been published that helps radio amateurs, CBers, experimenters and computer hobbyists locate equipment, parts, supplies and services. Over 600 sources of standard and hard to find gear are listed in the handy guide. Many of the 600 sources are mail order firms and many are discounters, too. All are firms that do business with electronics hobbyists.

The first section of the book lists the



firms alphabetically, their complete mailing addresses and phone numbers. Then, a list of the products or services they offer are provided along with key product information, minimum order amounts, shipping charges, etc. You'll find everything from the million dollar mail order firm that handles hundreds of product lines to the weekend garage operation offering a low cost accessory for a microprocessor or Citizen's Band transceiver.

The second section of the book is a breakdown of products and sources in over 200 categories. Under each category is a listing of all firms that sell or manufacture the items cross referenced to the first section. For instance, there are over 25 sources of low voltage (12.6 VDC to 13.8 VDC) power supplies and over 50 sources of digital ICs.

The buying guide contains many prices and sufficient detail that you can make your purchases directly from the book or obtain additional information to make your choice. Catalog prices, if any, are listed.

The last section of the book includes all sources by state so you can buy from the firm nearest you when there are several choices. You'll probably find some local firms that you didn't know existed.

The Underground Buying Guide is available only by direct mail from Peninsula Marketing Services, 12625 Lido Way, Saratoga CA 95070. The price is \$5.95 plus \$.55 postage and handling. Californians add \$.39 sales tax. Money-back guarantee within 10 days if you are not completely satisfied. ■

Attention Commercial and Industrial Users of the 8080

muPro Inc, 424 Oakmead Pky, Sunnyvale CA 94086, has just announced what may be one of the best 8080 oriented assemblers to come to market. This is the BSAL-80 assembler, a "block structured assembly language" which comes with a relocating and linking loader. Finally, someone in the microprocessor world has gotten around

Microcomputer Quay 80AI does much more with the Z-80.

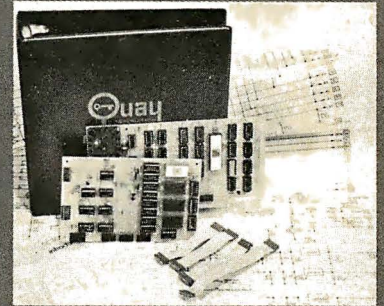

This dynamite new microcomputer system in a kit moves data like nothing else on the market. Run it alone or plug it into an S100 bus Altair/IMSAI. For solo performance, all you need is an unregulated power supply and an I/O device. Plugged in, Quay 80AI is a CPU, ROM, SIO, and RAM board—run any S100 compatible device. BUT MORE THAN THAT. Quay 80AI's Z-80 CPU opens challenging new areas of personal computing.

Features

- S100 bus compatible. Plugs in one slot of your Altair or IMSAI.
- Z-80 w/2.5 MHz clock.
- 1 K static RAM.
- 512 byte (ROM) monitor. Comes up running. Inspect, alter, dump, and load memory; set breakpoint; jump to user program. Handles serial I/O or keyboard input, including setting baud rate.
- 4 UVEPROM (2708) sockets.
- Serial I/O. RS-232 and 20 ma interface.
- Parallel keyboard input. Accepts standard ASCII keyboard.
- UVEPROM programmer. Program 2708 type UVEPROMs.
- 2 phase clock and sync. Run S100 compatible peripherals.
- 158 instructions. All 78 3080 instructions plus 80 new powerful instructions.
- On board voltage regulators.

Quay 80AI in a kit is \$450; factory assembled, \$600. Send for complete details. Or for fast action call 201-681-8700.

Mastercharge and BankAmericard accepted. COD with 1/3 deposit. N.J. residents add 5% sales tax. Price does not include shipping and handling.

Dealer inquiries invited.



P.O. Box 386, Freehold, N.J. 07728
Phone: 201-681-8700

to implementing some of those nice things which systems programmers have grown accustomed to on the bigger minicomputer and large scale computers! This product, according to the press release, "allows the user to write programs in a high level language syntax while retaining the flexibility, program size and execution speed of assembly language. The ability to utilize any of the 8080 machine instructions and to control the use of the architectural features of the 8080 is maintained."

Since the output is truly relocatable and has linkage information, the programmer is able to develop truly modular programs. The company also has available a line number oriented editor program and a loader program to go with

the assembler. The product is definitely aimed at commercial users, since its price is well out of the range of the individual user on a tight budget: The BSAL-80 assembler with BSAL-80 relocating/linking loader are available together for \$975 in 8080 resident form; the BSAL-80 text editor is available for \$350. The text editor, assembler and loader are available as a package for \$1250 and a FORTRAN IV cross assembly version is available for \$1250. The 8080 resident versions are provided free of charge with the purchase of the muPro-80, muPro-80E or muPro-80ED hardware and software development systems manufactured by the firm. Delivery of the software is quoted as immediate. ■

bytes as the 16 general purpose registers and another 32 bytes for the four floating point registers and use the remainder for control registers and pointers within the emulator.)

- Four IO ports implemented to interface external devices. (You'd use these ports to drive the address and data buses of the emulated computer system.)
- System development software in PROM to aid you in utilizing the board.
- 13 bit address bus and 16 bit data bus for the microprogram memory used to drive the 8X300. (This should be more than enough control store to build the aforementioned 360 emulator. For a microprogramming project you'd want to add up to 8 K by 16 bits of dual port programmable memory to this bus.)
- Diagnostic and instructional controls which include a WAIT mode to allow single step operation, oneshot instruction jamming, ability to change or examine internal registers, etc.

Contents of the kit (hardware) include an 8X300 processor, eight 82S116 programmable memories for the data store, two 82S115 512x8 PROMs with the systems software for evaluation use, miscellaneous TTL parts, the printed

Cogitate then Emulate with This Bipolar Controller . . .

The new Signetics 8X300 bipolar microprocessor device is now available in a single board design evaluation kit intended to titillate the fancies of the hardware designer . . . but guaranteed to find its way into a few homebrew experimenters' hands as one of the cheapest, fastest and easiest routes to a high performance microprogrammable emulator for existing or experimental processor architectures. At \$299 it's hard to argue with the features of this kit:

- 250 ns bipolar 8X300 processor. This processor handles 8 bits at a time with a read-modify-write cycle of 250 ns. (Yes, that's four instructions per microsecond!)
- 256 bytes of high speed working data storage. (In the use of this board as a microprogrammed emulator, this becomes the area used for the control data and general registers of the machine you emulate. If you're crazy enough to want to emulate a 360, for example, allocate 64 of these

How to Use the 8X300 Controller as an Emulator

notes by Carl Helmers, Editor

This figure shows the conceptual design of an emulator system built around your present microprocessor and the 8X300KT100SK kit of Signetics. The parallel IO ports of the general purpose microprocessor are used to address and load the programmable control store of the emulator (which you

have to assemble yourself from high speed chips or run the 8X300 at less than its full rated speed). Assuming that you start with a complete computer system which includes assembler or high level language, you write the software of a microassembler in order to create the emulation programs conveniently prior to loading the control store. You use the IO ports of the evaluation card (plus additional ones if necessary) to define the address and data bus structure of the machine you're emulating. If you're clever, you make this output of the 8X300 treat your old microprocessor's memory as its own via the DMA trick, but for initial testing it is probably better to dedicate a small amount of memory (perhaps 4 K bytes) exclusively to the emulated machine to avoid blow-ups due to wild programming of undebugged machine instructions. Through the control and status interfaces you tack onto the evaluation board kit, you make the emulated machine treat the old machine and its peripherals as its main IO devices, so that programs working in the new architecture can at least talk to you. The result of all this cogitation and wiring will be a microprogrammable computer architecture experimental rig which will be the envy of many an industrial laboratory or university computer science department — yet still at a cost within the advanced experimenter's budget. ■

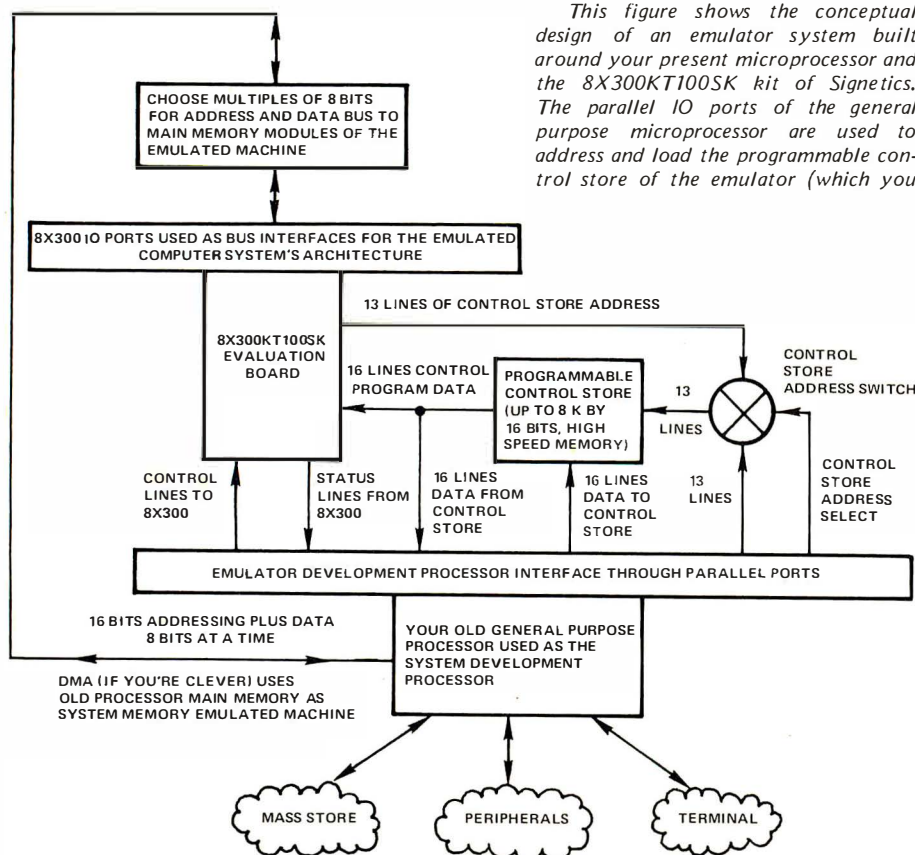

circuit, complete manual and assembly instructions. Signetics is located at 811 East Arques Av, Sunnyvale CA 94086, and the 8X300KT100SK is available from Signetics distributors. ■

What Makes the Z-1 Tick?

Cromemco has forwarded this picture of Harry Garland's Z-80 processor card which is what makes their new Z-1 computer "tick." According to Cromemco, they have an arrangement with Zilog to obtain a selected version of the Z-80 processor which can operate with a 4 MHz clock. Yet the card remains compatible with the Altair bus which is available from numerous manufacturers.

This processor card design has a crystal controlled 4 MHz clock which can drive the processor at either 4 MHz or 2 MHz depending upon a switch selected option. The use of memory wait

states enables the board to operate with mixes of fast and slow memory in the event that an older system is being upgraded to the 4 MHz clock rate.

An interesting feature which will prove most useful to those people who purchase the Cromemco Bytesaver EROM card (or its equivalent) in order to build permanent systems software loads is the new Cromemco Z-80 processor card's power on restart option which allows selection of an automatic restart vector to any 4 K boundary in memory address space. Thus if you put your monitor in EROM up at hexadecimal address F000, this board lets you set up an automatic restart jump to your monitor whenever you turn on the power (or if you're a true hacker, when you simulate power on with your own restart button).

This processor is available either in kit or in assembled form at prices of \$295 and \$395 respectively. Delivery is quoted as 15 to 30 days ARO (after

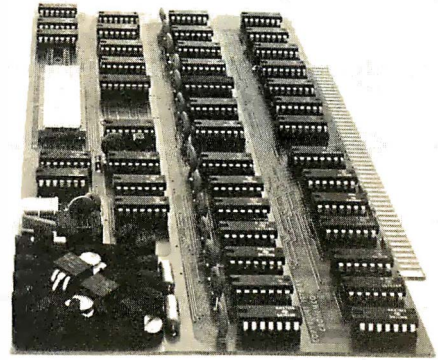

receipt of order). Cromemco also provides a Z-80 monitor, with complete documentation including source code and paper tape object code. Also available according to the press release is a Z-80 assembler and BASIC interpreter. Cromemco is located at 2432 Charleston Rd, Mountain View CA 94043. ■

A Matter of Form

We recently received a pad of coding forms for those who work in assembly or machine language, designed and sold by Walton Electronics. The forms are bound together in pads of 50 sheets and are formatted to accept code for the more popular microprocessors. Columns include: address, code, label, instruction and notes. Code can be written in either octal or hexadecimal with up to 3 bytes per line in regular assembler format. The lines are spaced to permit coding from a pica typewriter.

These forms make hand assembly easier and neater which helps eliminate errors. The pads sell for \$1.95 each postpaid. Quantity discounts are available. Order from Walton Electronics, POB 503, Bethany OK 73008, or check your nearest computer store. ■

Explore the Universe of Color

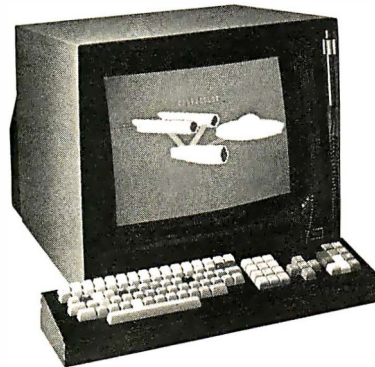

CompuColor Corp, Norcross GA 30071, announced plans in December 1976 to begin marketing a new 8 color

personal computer, the CompuColor 8001, in early December. According to the press release, the CompuColor 8001 is a stand alone CRT and microcomputer with both computation and graphics capabilities.

It is programmed to handle simple or complex tasks, from color graphics and income tax records to checkbook balancing, education instruction, tutoring and a unique variety of computer games. The unit features BASIC language, a 19 inch display screen, keyboard and tape memory. Options are also available.

The CompuColor is being marketed through retail computer stores nationwide, and no price was quoted with the press release. ■

INTERNATIONAL DATA SYSTEMS, INC.

400 North Washington Street, Suite 200
Falls Church, Virginia 22046 USA
Telephone (703) 536-7373

S100 Buss Cards (ALTAIR/IMSAI Compatible)		USES	KIT PRICE
88-SPM	Clock Module	Your computer keeps time of day regardless of what program it is executing. Applications include event logging, data entry, ham radio, etc.	\$96.00
88-UFC	Frequency Counter Module	Measure frequencies up to 600 MHz. Computer can monitor multiple frequencies such as transmit and receive frequency.	\$149.00
88-MODEM	Originate/Answer MODEM	Use your computer to call other computer systems such as large timesharing systems. Also allows other computer terminals to "dial-up" your computer.	\$199.00
GENERAL PURPOSE PERIPHERALS			
MCTK	Morse Code Trainer/Keyer	Hardware/Software package which allows your computer to teach Morse Code, key your transmitter, and send prestored messages.	\$29.00
TSM	Temperature Sensing Module	Use it to measure inside and/or outside temperature for computerized climate control systems, etc.	\$24.00
DAC8	Eight Bit Digital to Analog Converter	Requires one eight bit output port. Use it to produce computer music.	\$19.00

Terms: Payment with order. Shipment prepaid. Delivery is stock to 30 days. Write or call for detailed product brochures.

Comments on a Prototyping Bus

Webb Simmons
1559 Alcala PI
San Diego CA 92111

(See December 1976 BYTE, page 128.)

This concerns the proposal for a universal prototyping bus structure by David Washburn.

Mr Washburn raises some interesting points, none of which raise objections from me; however, when we dream let us dream boldly. It is not boldness to increase the address bus width from 16 bits to 18 bits. It is not boldness to replace the pseudostandard bus with an 88 connection bus.

A truly bold step for the address bus is to immediately go to 24 bits (3 bytes). The processor board can have two 8 bit registers, loaded by IO instructions (but it does not matter how they get loaded), to supply the upper 8 bits of an address. The choice of which upper register to use would be based upon whether it is an instruction fetch. *[Not necessarily possible to determine with any processor chip . . . CH]* In this way instruc-

tions and data can be arbitrarily far apart. The actual loading of the upper address register should be deferred by one instruction time to allow for a jump into the newly selected memory block. Many variations on this theme are possible and none would be binding upon any user. Merely allow 24 bits and let each person do his/her own thing.

Similar reasoning suggests 24 bits for the data bus. *[But why not go all the way to 32 ??? CH]* A person with true 16 bits of data may wish to use a Hamming code for error correction as well as (in lieu of) simple error detection. A 21 bit field is required to correct a one bit error in 16 bits (see the Data General description of their Eclipse computer). Once again a person may either use the extra bits or ignore them.

I rather like the thought of multiple inexpensive connectors, but why stop at two?

Some Comments on the Universal Bus Idea

M Faiman
Associate Professor of Computer Science
University of Illinois at Urbana-Champaign
Urbana IL 61801

David Washburn's comments in the December issue of BYTE on a universal bus structure are well taken. We ran into the problem he describes a couple of years ago when we started to experiment with microprocessors in our department. Every microprocessor, as your readers well know, has its own external signal configuration and protocol which all other devices — memory boards, IO interfaces, etc, must match in order to form a working system. Changing processors, even if they cost a mere \$25, necessitates a costly redesign of all the associated device interfaces. Since there are typically many of the latter for only one of the former, this is

obviously an expensive and, in most instances, impractical business.

Our solution, after studying the characteristics of the popularly available and projected microprocessors, was to design our own Modular Unified Microprocessor System — MUMS (1, 2, 3, 4). This system has undergone two design iterations since its inception, and its chief characteristics may be summarized as follows:

1. The hardware utilizes a fairly simple, uniform bus structure that is processor independent. There is one microprocessor per bus, and it and all other devices intercommunicate via a small set of generic signals (see item 5 below).
2. The bus signal protocol is chosen so that the most numerous modules in a system require only the simplest, ie: least expensive, interfaces.

Use three connectors or even four. When a user has no need for the extra connectors they can be omitted from the mother board. The standard board size might increase somewhat but the extra square inches will not be very expensive.

The 3 bit "speed code" set by each memory board seems to have no advantage over a one bit "data ready" signal from memory. Unless and until the data is truly ready the processor can do nothing sensible anyway. Many computers already allow for asynchronous memory with an indefinite wait for data ready, so this is not new.

Concerning standard peripheral device numbers, why not define them in the range from a low of zero to a high of 255? Then allow anyone to append one or two upper bytes to this low byte of standard assignments. The upper byte (or bytes) could be set with jumpers or dip switches. This will allow the spirit of standard device assignments and still let a user put them where he wishes.

For multiple processors (eg: 2) let us not overlook the possibility of Y shaped memory in which each processor gets its instructions from its own branch of the Y without conflicts with the other processor. For data the processors can share the common branch and most of the time both processors can run at near full speed. ■

16 K STATIC RAM

For ALTAIR / IMSAI / POLY 88

\$459 KIT
ASSEMBLED \$529

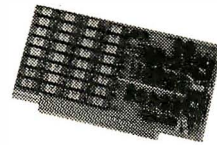

- USES 4K STATIC RAMS - NO REFRESH
- VERY LOW POWER - LESS THAN 1 AMP
- Z80 FAST - 200ns ACCESS TIME
- PROVISION FOR BATTERY BACKUP
- LOW PROFILE SOCKETS FOR ALL CHIPS
- EACH 4K ADDRESSABLE TO ANY 4K SLOT
- HARDWARE/SOFTWARE MEMORY PROTECT FOR EACH 4K
- SPECIAL PAGING OPTION ALLOWS UP TO 1 MEGABYTE ADDRESSABLE MEMORY
- LOW COST

CONSTRUCTION MANUAL \$1.75
 PAGING OPTION \$9.00
 QUANTITY DISCOUNT 5 BOARDS — 5%
 10 OR MORE — 10%

DEALER INQUIRIES INVITED

OMNI SYSTEMS INC.
 P.O. BOX 7536, UNIV. STATION
 PROVO, UTAH 84602

READER SERVICE NO. 198

3. To sidestep the spread in timing requirements of different processors the mode of communication on the bus is asynchronous. A particular advantage of this is that memory boards of differing access/cycle times can be used in the same system. (There is no need for the "speed code" number that Mr Washburn describes.)
4. Multiprocessing is accomplished with the aid of a TIE module and, optionally, a COM-UNIT. The former plugs into any MUMS bus and appears to the processor as a DMA device. From its other end a 4 wire line (10 MHz serial) can talk to a similar module on another bus for dual processor activity, or to the COM-UNIT — in process of design right now — which will handle communication between up to 16 processors.
5. The bus is physically implemented on a 72 pin connector (DEC compatible), as shown in the figure. Of these, the DATA, ADDRESS and POWER lines are self-explanatory. The others have mnemonic names, as follows:

FREE

the new
Heathkit
catalog!

Featuring the
test equipment
and accessories
you've been
looking for in
money-saving,
easy-to-build
kit form.



And our new catalog also lists hi-fi, television, amateur radio products and much more... nearly 400 quality electronic kits for your every interest. You'll find Heathkit building easy and enjoyable with our famous step-by-step assembly manuals. And we won't let you fail. Should you have the slightest problem, an experienced staff of technical advisors awaits your phone call.

Send for your FREE catalog today. You'll see why quality, reliability and serviceability are familiar words to a Heathkit customer.

Heath Company, Dept. 334-27, Benton Harbor, Michigan 49022

HEATH
Schlumberger Heath Company, Dept. 334-27
 Benton Harbor, Michigan 49022

Please send my FREE Heathkit catalog. I am not on your mailing list.

Name _____

Address _____

City _____ State _____

CL-627 Zip _____

Expansion	BD15	- 1A	2A	- BD7	DATA
	BD14	- 1B	2B	- BD6	
	BD13	- 1C	2C	- BD5	
	BD12	- 1D	2D	- BD4	
	BD11	- 1E	2E	- BD3	
	BD10	- 1F	2F	- BD2	
	BD9	- 1H	2H	- BD1	
	BD8	- 1J	2J	- BD0	
		x 1K	2K	x	
		x 1L	2L	x	
Component Side of Card	BA15	- 1M	2M	- BA7	ADDRESS
	BA14	- 1N	2N	- BA6	
	BA13	- 1P	2P	- BA5	
	BA12	- 1R	2R	- BA4	
	BA11	- 1S	2S	- BA3	
	BA10	- 1T	2T	- BA2	
	BA9	- 1U	2U	- BA1	
	BA8	- 1V	2V	- BA0	
Component Side of Card	GND	- 3A	4A	- GND	POWER
	GND	- 3B	4B	- GND	
	+5	- 3C	4C	- +5	
	+12	- 3D	4D	- +12	
	-12	- 3E	4E	- -12	
		x 3F	4F	x	
	$\overline{\text{RST}}$	- 3H	4H	- $\overline{\text{ACK}}$	
		x 3J	4J	x	
	$\overline{\text{RAV}}$	- 3K	4K	- $\overline{\text{WAV}}$	
		x 3L	4L	x	
$\overline{\text{WHD}}$	- 3M	4M	- $\overline{\text{WLD}}$	CONTROL	
$\overline{\text{DGI}}$	- 3N	4N	- $\overline{\text{DGO}}$		
I/O	- 3P	4P	- $\overline{\text{DMR}}$		
ISN	- 3R	4R	- $\overline{\text{IVV}}$		
IGI	- 3S	4S	- IGO		
IA3	- 3T	4T	- $\overline{\text{IR3}}$		
IA2	- 3U	4U	- $\overline{\text{IR2}}$		
IA1	- 3V	4V	- $\overline{\text{IR1}}$		

MUMS Bus - Signal Layout

$\overline{\text{RST}}$	- Power on reset
$\overline{\text{RAV}}$	- Read Address Valid (from processor DMA device to memory or IO device register)
$\overline{\text{WAV}}$	- Write Address Valid (similarly)
$\overline{\text{ACK}}$	- Acknowledge (opposite direction)
$\overline{\text{WLD}}$	- Write Low Data byte
$\overline{\text{WHD}}$	- Write High Data byte

$\overline{\text{DMR}}$	- DMA device Request
DGI/DGO	- DMA Grant In/Out (daisy chained signal)
IO	- Used in conjunction with appropriate memory control signals to access an IO page.
ISN	- Interrupt Sync (processor generated)
$\overline{\text{IRi}}$	- Interrupt Request for level i (i = 1,2,3)
IAi	- Interrupt Acknowledge for level i
IGI/IGO	- Interrupt Grant In/Out (daisy chained signal)
$\overline{\text{IVV}}$	- Interrupt Vector Valid (device to processor)

It is obviously beyond the scope of this letter to describe timing relationships in detail, but the interested reader may find particulars in references 2 and 4 below. ■

REFERENCES

1. Faiman, M: Modular, Unified Microprocessor System (MUMS), ACM Computer Science Conference Abstracts, page 19, February 1976.
2. Catlin, R W: MUMS: A Modular, Unified Microprocessor System, (50 pages, Technical Report UIUCDCS-R-76-809, University of Illinois, Urbana-Champaign), IEEE Computer Society Repository #R76-245.
3. Faiman, M, Catlin, R W and Weaver, A C: A Modular, Unified Microprocessor System (MUMS), Proceedings of the IEEE DISE Workshop on Microprocessors, pages 1-5, Colorado State University, August 1976.
4. Faiman, M, Weaver, A C and Catlin, R W: MUMS - A Reconfigurable Microprocessor Architecture, *Computer*, January 1977.



Computer Power & Light

Gene Morrow, president of Computer Power & Light, a computer store located at 12321 Ventura Blvd, Studio City CA 91604, has sent along a brochure describing his firm's packaged 8080 processor system. The Computer Power & Light COMPAL-80 computer is a fully assembled system for homes and small

businesses, which includes the following main features:

- 8080A processor
- audio tape serial interface port
- Teletype or RS-232 serial port
- 12 K programmable memory
- 16 line by 64 character video display with full ASCII character set and graphics
- 9 inch high resolution monitor
- ASCII keyboard with capacitance switch mechanisms
- case and cabinetry with cooling fan, chassis connectors for interfaces, "turn key" configuration
- PROM monitor to eliminate the need of a costly front panel
- 10 K extended BASIC including formatted PRINT, double precision, all transcendental functions, etc.

The price on the above package of features is quite reasonable - for \$1863

you get a completely assembled system which can be viewed and examined in Gene's store. Gene's press release claims that several systems already have been delivered including one which is in use at Mt St Mary's College in Los Angeles as part of a computer programming curriculum, another which is being used to keep track of inventory in a retail store in Santa Barbara, and another in an industrial laboratory. For more information, contact Gene at the store. ■

A New Version of SC/MP

National Semiconductor has now introduced a new version of the SC/MP processor (see Robert Baker's article in September 1976 BYTE, page 76). This newer version is implemented with a faster NMOS technology with the following essential points of improvement:

- Twice as fast in execution (3.58 or 4.0 MHz on chip crystal)
- One quarter of the power requirements (200 mW versus 800 mW)
- Compatibility with the previous product
- Single power supply

According to the press release, this new version is being sampled from the factory at \$17.76 for single quantities and in 1977 the production quantities of 1000 or more will sell "significantly below \$10 each" when it becomes available in a plastic package. National Semiconductor also plans to have available a retrofit kit for present owners of SC/MP kits, which will allow conversion to the new processor. The price for this product is not yet announced.

This is the kind of processor which rapidly becomes a commodity part, and

can thus be buried into all manner of dedicated application products with appropriate read only memory software designs and special purpose peripheral hardware. For an example of such dedicated products, consider the dedicated electronic music synthesizer module: Hypothesizing a \$2 to \$5 price for a plastic package version of this computer, using perhaps 1 or 2 K of 2708 storage for control programs, and perhaps 1 K or so of programmable memory for parameters, it should be possible to engineer an inexpensive stand-alone music synthesizer module which will sit on a computer table and take orders through a high speed serial port and RS-232 level receivers.

National Semiconductor is located at 2900 Semiconductor Dr Santa Clara CA 95051. National Semiconductor parts and products are available through most nationwide electronic distributors. ■

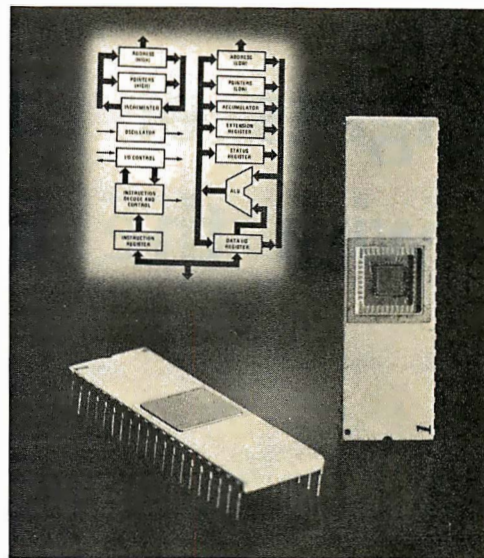

Floppy Disk Controller And a Hint about a Future Article

NEC Microcomputers Inc, Five Militia Dr, Lexington MA 02173, has a pair of the most advanced LSI devices available for peripheral control in microprocessor systems. This pair consists of the uPD372D floppy disk controller chip (now available at \$54 in quantities of 1 to 24) and the uPD371D cassette controller chip (also available, in quantities of 1 to 24 quoted at \$48). Both these items are available from a nationwide network of distributors, which in New England includes Harvey Electronics, Semiconductor Specialists and Sterling Electronics. Tim Schoechle, of the Technical Staff for Microprocessors of NEC, sent along the latest technical manual on

the floppy disk controller chip, for use as a reference in editing a forthcoming article by Ira Rampil which reviews both of these controllers.

When you buy one of these chips, you get a fixed purpose processor which is customized to the job at hand. As described in the 68 page uPD372D disk controller manual (dated December 3 1976, which we understand was written by Tim), the chip takes care of all the housekeeping and formatting requirements at the hardware level needed to create floppy disk records with IBM 3740 format, Shugart Minifloppy format, etc. It also generates and checks cyclic redundancy characters, can be synchronized with address marks or physical indices (so called "hard sec-

tors"), and will handle up to four floppy disk drives through separate select lines. Furthermore, it has the capacity to overlap input and output control of two separate drives. Taking into account differences in hardware, the track to track stepping rate and stepping pulse width outputs are programmable, as is the sector size and data rate. A list of 13 drives with which the chip is compatible is given by manufacturer and model number. More detailed information will have to wait for Ira's article — but for the engineers or homebrewers who can't wait, the information is available from NEC or its representatives: Ask for the "uPD372D LSI Floppy Disk Controller Chip User's Manual." ■

MVM 1024 MICROPROCESSOR VIDEO MODULE

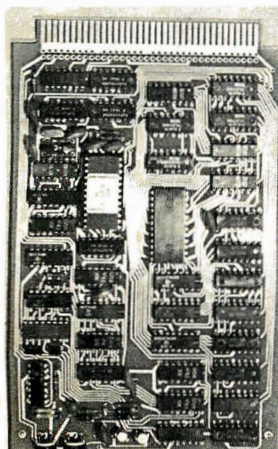

- * Sixteen 64-character lines, upper/lower case 128 character font.
- * Software-controllable reverse video characters.
- * Full read and write capability for both cursor position and character code.
- * Interfaces to any microprocessor: 8080, 6800, 6502, etc.
- * Scrolling, line/character insert/delete, etc. easily done with software.

\$ 225
ASSEMBLED
AND TESTED

THE SOPHISTICATED VIDEO MODULE
FOR THE ADVANCED EXPERIMENTER

Write or call for complete literature.

 **Riverside**
ELECTRONIC DESIGN INC.

1700 NIAGARA STREET
BUFFALO, N.Y. 14207
716 875-7070

Flights of Fancy with the Enterprise

David Price
3901 Victoria Ln
Midlothian VA 23113

Listing 1: The Star Trek program, expressed in BASIC. For notes on conversion to Altair BASIC see the text. This version requires 9382 bytes of work space for the program text, 161 matrix elements, and 46 bytes of character string space. The approximate total size requirement is thus 10 K bytes, plus the size of the BASIC interpreter itself. Using a 12 K extended BASIC interpreter, this program would thus require approximately 22 K of programmable memory in a typical microcomputer system. Hurrah for the 16 K chips!

```

STR
10 REM ***** STAR TREK *****
20 REM ****
30 REM **** STTR: SPACE WAR SIMULATION ****
40 REM ****
50 REM **** PROGRAM BY DAVID PRICE ****
60 REM *****
70 DEF FNA(X)=INT(X*RND()+1)
80 DIM G(8,8),Z$(15),C$(6),X$(24)
90 T0=T=(FNA(20)+20)*100
100 E=3000
110 P=15
120 S=0
130 X$="-----"
140 DEF FND(D)=SQR((K(I,1)-S)2+(K(I,2)-S)2)
150 Q1=Q2=S1=S2=FNA(8)
160 MAT C=CON(9,2)
170 C(2,1)=C(3,1)=C(4,1)=C(4,2)=C(5,2)=C(6,2)=-1
180 C(1,1)=C(3,2)=C(5,1)=C(7,2)=C(9,1)=0
190 MAT D=ZER(6)
200 B9=K9=0
210 FOR I=1 TO 8
220 FOR J=1 TO 8
230 K3=B3=0
240 IF RND(1)<.8 THEN 270
250 K3=FNA(3)
260 K9=K9+K3
270 IF RND(1)<.96 THEN 300
280 B3=1
290 B9=B9+1
300 S3=FNA(5)
310 G(I,J)=K3*100+B3*10+S3
320 NEXT J
330 NEXT I
340 IF K9=0 OR B9=0 THEN 200
350 GOTO 3570
360 IF Q1 >= 1 THEN 380
370 S1=Q1=1
380 IF Q1 <= 8 THEN 400
390 S1=Q1=8
400 IF Q2 >= 1 THEN 420
410 S2=Q2=1
420 IF Q2 <= 8 THEN 440
430 S2=Q2=8
440 X=GC(Q1,Q2)/100
450 K3=INT(X)
460 B3=INT((X-K3)*10)
470 S3=GC(Q1,Q2)-((B3*10)+(K3*100))
480 IF K3=0 THEN 520
490 PRINT "COMBAT AREA," "CONDITION RED"
500 IF S>(K3*100) THEN 520
510 PRINT "SHIELDS DANGEROUSLY LOW"
520 MAT K=ZER(3,3)
530 MAT Q=ZER(8,8)
540 Q(S1,S2)=1
550 FOR I=1 TO K3
560 GOSUB 3500
570 Q(R1,R2)=2
580 K(I,1)=R1
590 K(I,2)=R2
600 K(I,3)=200
610 NEXT I
620 IF B3=0 THEN 650
630 GOSUB 3500
640 Q(R1,R2)=4
650 FOR I=1 TO S3
660 GOSUB 3500
670 Q(R1,R2)=3

```

The main objective of this version of the Star Trek game is to destroy all of the Klingon battle cruisers within 30 stardates. The Klingons and starbases are randomly positioned within a simulated galaxy. To help you better visualize this galaxy we use quadrant sector notation.

The galaxy is divided into a matrix of 8 by 8, or 64, quadrants. Each quadrant is further subdivided into an array of 8 by 8 sectors. The United Space Ship Enterprise, of which you are captain, has been assigned to seek out and destroy all of the Klingon invaders. You have at your disposal a bristling array of sophisticated weaponry including phasers, photon torpedoes, and an onboard computer, which are triggered by

Once upon a time there was Star Trek. During its brief but eventful life as a television series it not only won acclaim from within the science fiction community, but was also hailed by the popular media as one of the first truly intelligent shows on television. It attracted an entirely new type of audience to science fiction including many from the computer crowd. By showing us glimpses of a distant future, it allowed us to take a more objective look at the present. Star Trek now survives only in rerun form and in the games of computer people. Those computer people who happen to be Trekkies have adopted the Star Trek theme as their own. Everybody under the sun has been programming games based loosely on Star Trek. These games have evolved into some of the most complex computer games ever written. Yet, lurking beneath this complexity lies a startling amount of realism.

your direct orders. To utilize the facilities of the Enterprise you enter simple numerical commands. Figure 1 shows the flowchart for the initialization of the variables used in the program and the first quadrant set up. The flowchart also indicates on what lines of the program the various operations take place.

The Command Set

Figure 2 shows the flowchart for entering commands to the program. The commands are numbers which are tested by the program to determine what to do.

Command 0 places you in control of the warp engines which are used to propel the Enterprise from one location to another. You are first asked for the direction in which you wish to travel. The trajectory angles are arranged on a circular vector as shown in figure 3.

Listing 1, continued:

```

680 NEXT I
690 GOSUB 2600
700 PRINT "COMMAND:";
710 INPUT A
720 IF A<1 OR A>5 OR A#INT(A) THEN 780
730 R1=A+1
740 IF DCR1 >= 0 THEN 780
750 GOSUB 3420
760 PRINT Z$;" NOT OPERATIONAL"
770 GOTO 700
780 GOTO (A+1) OF 890,1520,1640,1800,2200,3010,3550
790 PRINT
800 PRINT "0=SET COURSE";TAB(20);"4 3 2"
810 PRINT "1=LONG RANGE SCAN";TAB(21);"\" "/"
820 PRINT "2=PHASER CTRL";TAB(22);"\" "/"
830 PRINT "3=TORPEDO CTRL";TAB(18);"5 ----- 1"
840 PRINT "4=SHIELDS";TAB(22);"\" "/"
850 PRINT "5=LIBRARY COMPUTER";TAB(21);"\" "/"
860 PRINT "6=RESIGNATION";TAB(20);"6 7 8"
870 PRINT
880 GOTO 700
890 PRINT "COURSE (1-9):";
900 INPUT C1
910 IF C1<1 OR C1 >= 9 THEN 700
920 PRINT "WARP FACTOR (0-8):";
930 INPUT W1
940 IF W1 <= 0 OR W1>8 THEN 700
950 IF DCR1 >= 0 OR W1 <= .5 THEN 980
960 PRINT "ENGINES ARE DAMAGED, MAXIMUM SPEED= WARP .5"
970 GOTO 920
980 IF E-(W1*8)>0 THEN 1030
990 IF S<1 THEN 2470
1000 PRINT "YOU ONLY HAVE";E;"UNITS---SUGGEST YOU CROSS-CIRCUIT"
1010 PRINT "FROM SHIELDS, WHICH HAVE";S;"UNITS"
1020 GOTO 700
1030 FOR I=1 TO 6
1040 IF DCR1 >= 0 THEN 1060
1050 DCR1=DCR1+1
1060 NEXT I
1070 IF FNA(10)#5 OR W1<2 THEN 1120
1080 R1=FNA(6)
1090 DCR1=DCR1-FNA(5)
1100 GOSUB 3420
1110 PRINT LIN(1),"DAMAGE CTRL REPORTS ";Z$;" DAMAGED.";LIN(1)
1120 N=INT(W1*8)
1130 Q(S1,S2)=0
1140 X=S1
1150 Y=S2
1160 C2=INT(C1)
1170 X1=C[C2,1]+(C[C2+1,1]-C[C2,1])*(C1-C2)
1180 X2=C[C2,2]+(C[C2+1,2]-C[C2,2])*(C1-C2)
1190 FOR I=1 TO N
1200 S1=S1+X1
1210 S2=S2+X2
1220 IF S1<1 OR S1>8 OR S2<1 OR S2>8 THEN 1360
1230 IF Q(INT(S1),INT(S2))=0 THEN 1270
1240 S1=S1-X1
1250 S2=S2-X2
1260 GOTO 1280
1270 NEXT I
1280 S1=INT(S1)
1290 S2=INT(S2)
1300 Q(S1,S2)=1
1310 E=E-N
1320 IF W1<1 THEN -690
1330 T=T+1
1340 IF T>T0+30 THEN 2500
1350 GOTO 690
1360 X=Q1*8+X+X1*N
1370 Y=Q2*8+Y+X2*N
1380 Q1=INT(X/8)
1390 Q2=INT(Y/8)
1400 S1=INT(X-Q1*8+.5)
1410 S2=INT(Y-Q2*8+.5)
1420 IF S1>0 THEN 1450
1430 Q1=Q1-1
1440 S1=8
1450 IF S2>0 THEN 1480
1460 Q2=Q2-1
1470 S2=8
1480 T=T+1
1490 E=E-N+5
1500 IF T>T0+30 THEN 2500
1510 GOTO 360
1520 PRINT X$(1,17)
1530 FOR I=Q1-1 TO Q1+1
1540 MAT N=ZER(3)
1550 FOR J=Q2-1 TO Q2+1
1560 IF I<1 OR I>8 OR J<1 OR J>8 THEN 1580
1570 N[J-Q2+2]=GCI,J)
1580 NEXT J
1590 PRINT USING 1630;N(1),N(2),N(3)
1600 PRINT X$(1,17)
1610 NEXT I
1620 GOTO 700
1630 IMAGE=" ",3(3D," ");
1640 IF K3=0 THEN 2350
1650 PRINT "ENERGY AVAILABLE=";E
1660 PRINT "NUMBER OF UNITS TO FIRE:";
1670 INPUT X
1680 IF X<1 THEN 700
1690 IF E-X<0 THEN 1660
1700 E=E-X
1710 FOR I=1 TO 3
1720 IF K(I,3)=0 THEN 1780
1730 H=INT(X/K3/(FND(0)))
1740 K(I,3)=K(I,3)-H
1750 PRINT H;"UNIT HIT ON KLINGON"
1760 IF K(I,3)>0 THEN 1780
1770 GOSUB 2050
1780 NEXT I

```

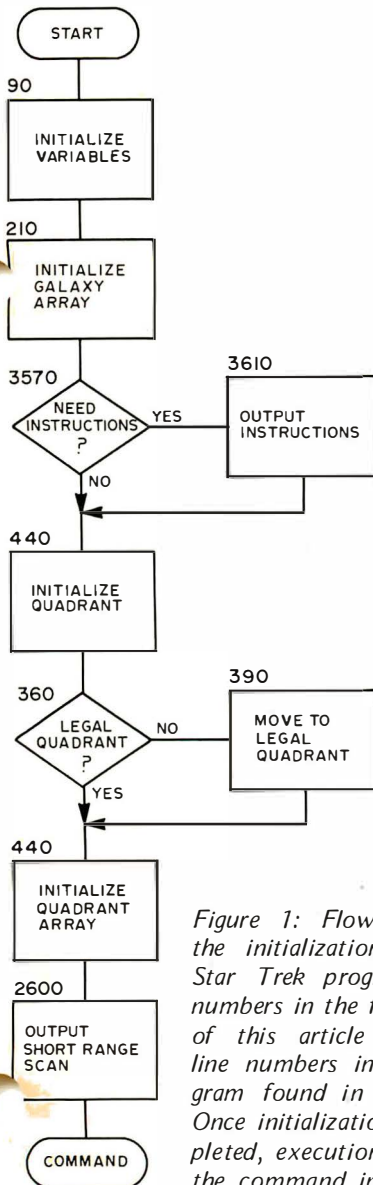

Figure 1: Flowchart for the initialization of the Star Trek program. The numbers in the flowcharts of this article refer to line numbers in the program found in listing 1. Once initialization is completed, execution flows to the command interpreter.

Listing 1, continued:

```

790 GOTO 2030
800 IF P>0 THEN 1830
810 PRINT "ALL PHOTON TORPEDOES EXPENDED"
820 GOTO 700
830 PRINT "TORPEDO COURSE (1-9):";
840 INPUT C1
850 IF C1<1 OR C1 >= 9 THEN 700
860 C2=INT(C1)
870 X1=C(C2,1)+(C(C2+1,1)-C(C2,1))*(C1-C2)
880 X2=C(C2,2)+(C(C2+1,2)-C(C2,2))*(C1-C2)
890 X=S1
900 Y=S2
910 P=P-1
920 PRINT
930 X=X+X1
940 Y=Y+X2
950 IF X<1 OR X>8 OR Y<1 OR Y>8 THEN 2180
960 IF Q(INT(X),INT(Y))=0 AND Q(INT(X+.5),INT(Y+.5))=0 THEN 1930
970 FOR I=1 TO 3
980 IF INT(X)=K(I,1) AND INT(Y)=K(I,2) THEN 2020
990 IF INT(X+.5)=K(I,1) AND INT(Y+.5)=K(I,2) THEN 2020
2000 NEXT I
2010 GOTO 2120
2020 GOSUB 2050
2030 GOSUB 2070
2040 GOTO 700
2050 K(I,3)=Q(K(I,1),K(I,2))=0
2060 PRINT "***KLINGON DESTROYED***"
2070 K3=K3-1
2080 K9=K9-1
2090 IF K9=0 THEN 2550
2100 G(C1,Q2)=G(C1,Q2)-100
2110 RETURN
2120 IF Q(INT(X),INT(Y))#3 THEN 2150
2130 PRINT "YOU CAN'T DESTROY STARS. SILLY!"
2140 GOTO 2180
2150 PRINT "***STARBASE DESTROYED***"
2160 PRINT "YOU ARE HEREBY RELIEVED OF DUTY!! CONGRATULATIONS!"
2170 GOTO 2530
2180 PRINT "TORPEDO MISSED"
2190 GOTO 2030
2200 PRINT "ENERGY AVAILABLE=";E+S
2210 PRINT "NUMBER OF UNITS TO SHIELDS:";
2220 INPUT X
2230 IF X<0 THEN 700
2240 IF E+S-X<0 THEN 2210
2250 E=E+S-X
2260 S=X
2270 GOTO 700
2280 PRINT LIN(1);"DEVICE","STATE OF REPAIR"
2290 FOR R1=1 TO 6
2300 GOSUB 3420
2310 PRINT Z$,DIR1]
2320 NEXT R1
2330 PRINT
2340 GOTO 700
2350 PRINT "SHORT RANGE SENSORS REPORT NO KLINGONS IN THIS QUADRANT"
2360 GOTO 700
2370 IF C$="DOCKED" THEN 2460
2380 IF K3=0 THEN 2460
2390 FOR I=1 TO 3
2400 IF K(I,3)=0 THEN 2450
2410 H=INT(K(I,3)/FND(0)+1)
2420 S=S-H
2430 PRINT H;"UNIT HIT ON ENTERPRISE"
2440 IF S<0 THEN 2520
2450 NEXT I
2460 RETURN
2470 PRINT "***FATAL ERROR***"
2480 PRINT "THE ENTERPRISE IS DEAD IN SPACE, AND MUST BE EVACUATED!!"
2490 GOTO 2530
2500 PRINT LIN(1);"IT IS STARDATE";T
2510 GOTO 2530
2520 PRINT LIN(1);" ***THE ENTERPRISE HAS BEEN DESTROYED***"
2530 PRINT LIN(1);"THE FEDERATION WILL BE CONQUERED!!!"
2540 GOTO 3560
2550 PRINT
2560 PRINT "THE LAST KLINGON BATTLE CRUISER HAS BEEN DESTROYED!!"
2570 PRINT "THE FEDERATION HAS BEEN SAVED !!!"
2580 PRINT
2590 GOTO 3560
2600 FOR I=S1-1 TO S1+1
2610 FOR J=S2-1 TO S2+1
2620 IF I<1 OR I>8 OR J<1 OR J>8 THEN 2640
2630 IF Q(I,J)=4 THEN 2670
2640 NEXT J
2650 NEXT I
2660 GOTO 2730
2670 C$="DOCKED"
2680 E=3000
2690 P=15
2700 MAT D=ZER
2710 S=0
2720 GOTO 2810
2730 PRINT
2740 IF K3>0 THEN 2780
2750 IF E<300 THEN 2800
2760 C$="GREEN"
2770 GOTO 2810
2780 C$="RED"
2790 GOTO 2810
2800 C$="YELLOW"
2810 PRINT X$
2820 Z=0
2830 GOSUB 3330
2840 PRINT
2850 GOSUB 3330
2860 PRINT "STARDATE";SPA(5);T
2870 GOSUB 3330
2880 PRINT "CONDITION";SPA(5);C$
2890 GOSUB 3330
2900 PRINT "ENERGY";SPA(7);E

```

Figure 2: Command interpreter. A very simple interpreter is employed by the program. It requests a command input, tests the command for validity with a computed GO TO at line 780 to activate the appropriate command segment. Invalid commands fall through the GO TO statement and lead to printing of a command list on the output display.

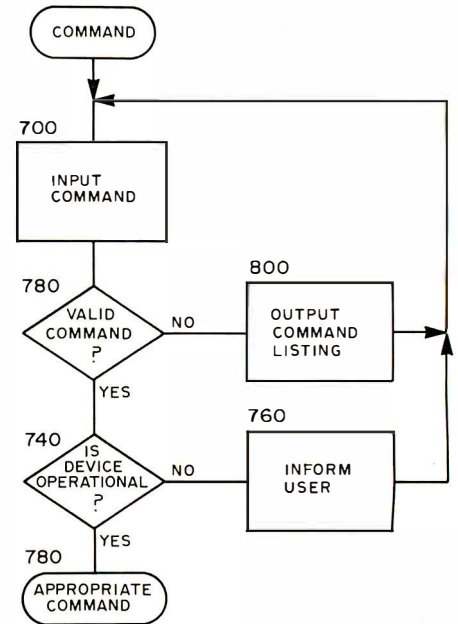

One warp factor represents the length of one quadrant. It is possible to move very short distances by using warp factor values less than one. Every time you move to a new location, you will get what is known as a short range scan which is a printout of the quadrant you are currently in. The symbols used in the short range scan are:

```

Enterprise <*>
star *
Klingon +++
starbase >!<

```

Figure 4 shows the actions which take place during the execution of this command.

Occasionally, after using enough warp factors to get you to who knows where, you will discover that you haven't gotten anywhere. This is because you have run into something, probably a star. Fortunately, your warp engines will always bring you to a screeching halt in time to prevent an accident. This is why it is a good idea to check your short range scan before laying out a

Figure 3: Course vector diagram. Numbers are used to determine the direction in which the Enterprise will move, or a photon torpedo is fired. These numbers are related to the points of a compass as shown here; fractional values are used to generate points in between these major headings.

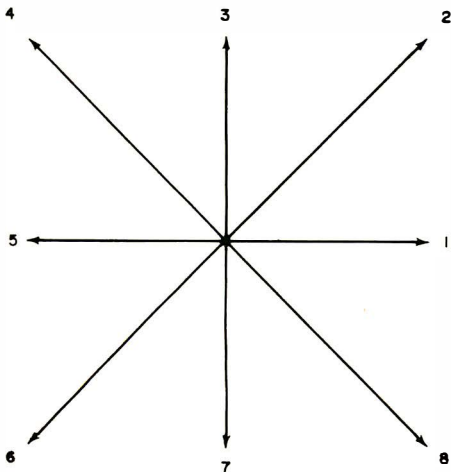

course, to make sure you have a clear path to your destination.

Command 1 will output a long range scan. A long range scan is a table containing information on the quadrants bordering the one you are in. It is arranged on a 3 by 3 grid, with your own quadrant being the one in the center. You are given a three digit number for each quadrant. The hundreds digit of this number is the number of Klingon ships in that quadrant. The tens digit is the number of starbases, and the ones digit is the number of stars. Be sure to remember that leading zeroes will be suppressed on the printout. Sometimes an entire row on the long range scan will be made up of zeroes. This represents the edge of the galaxy, the perimeter of your range. The warp engines will not permit you to enter this area. Instead, you will bounce off the edge.

Command 2 is the phaser firing section. You may destroy a Klingon ship by firing enough units of phaser power to deplete his shields. The question is, how many units are necessary to do this? One factor you must consider is the amount of energy he has in his deflector shields. For every unit of energy you hit him with, his shields drop a corresponding amount. Your distance from the Klingon also matters since the amount of energy that reaches him lessens with distance. Your sensors will tell you how successful you have been in damaging the Klingons. Your phaser fire is evenly divided

Listing 1, continued:

```

2910 GOSUB 3330
2920 PRINT "TORPEDOES";SPA(4);P
2930 GOSUB 3330
2940 PRINT "SHIELDS";SPA(6);S
2950 GOSUB 3330
2960 PRINT "KLINGONS";SPA(5);K9
2970 GOSUB 3330
2980 PRINT
2990 PRINT X$
3000 RETURN
3010 PRINT "COMPUTER ACTIVE AND AWAITING COMMAND";
3020 INPUT A
3030 GOTO (A+1) OF 2280,3100,3310
3040 PRINT "FUNCTIONS AVAILABLE FROM COMPUTER"
3050 PRINT " 0=DAMAGE REPORT"
3060 PRINT " 1=PHOTON TORPEDO DATA"
3070 PRINT " 2=SHORT RANGE SCAN"
3080 PRINT
3090 GOTO 3010
3100 PRINT
3110 FOR I=1 TO 3
3120 IF K[I,3] <= 0 THEN 3200
3130 X=K[I,2]-S2
3140 Y=S1-K[I,1]
3150 IF X=0 THEN 3240
3160 A=INT(((57+3*ATN(Y/X))/45+1)*100)/100
3170 IF X>0 AND Y<0 THEN 3290
3180 IF X<0 THEN 3220
3190 PRINT "DIRECTION=";A
3200 NEXT I
3210 GOTO 700
3220 A=A+4
3230 GOTO 3190
3240 IF Y<0 THEN 3270
3250 A=3
3260 GOTO 3190
3270 A=7
3280 GOTO 3190
3290 A=A+8
3300 GOTO 3190
3310 GOSUB 2600
3320 GOTO 700
3330 REM ***** OUTPUT QUADRANT *****
3340 Z=Z+1
3350 FOR I=1 TO 8
3360 Z$=" <*>+++ * >!<"
3370 PRINT Z$(Q[Z,1]*3+1,Q[Z,1]*3+3);
3380 NEXT I
3390 IF Z=1 OR Z=8 THEN 3410
3400 PRINT SPA(5);
3410 RETURN
3420 REM ***** PRINTS DEVICE NAME *****
3430 RESTORE 3440
3440 DATA "WARP ENGINES","SCANNERS","PHASER BANKS","TORPEDO TUBES"
3450 DATA "SHIELD CTRL","COMPUTER"
3460 FOR X=1 TO 81
3470 READ Z$
3480 NEXT X
3490 RETURN
3500 REM **** PLACEMENT IN QUADRANT ARRAY ****
3510 R1=FNA(8)
3520 R2=FNA(8)
3530 IF Q[R1,R2]#0 THEN 3510
3540 RETURN
3550 PRINT LIN(1),"YOUR RESIGNATION HAS BEEN *ACCEPTED*"
3560 STOP
3570 PRINT "DO YOU NEED INSTRUCTIONS";
3580 INPUT A$
3590 PRINT LIN(5)
3600 IF ASC(1,1)="#Y" THEN 440
3610 PRINT SPA(5);"<*> =ENTERPRISE"
3620 PRINT SPA(5);" * =STAR"
3630 PRINT SPA(5);"+++ =KLINGON"
3640 PRINT SPA(5);">!< =STARBASE"
3650 PRINT LIN(2)
3660 PRINT "COMMAND 0=WARP ENGINES"
3670 PRINT "COURSE IS IN A CIRCULAR VECTOR AS SHOWN.";TAB(50);"4 3 2"

3680 PRINT "REAL VALUES MAY BE USED. FOR EXAMPLE.";TAB(51);"\ ^ /"
3690 PRINT "1.5 WOULD BE HALFWAY BETWEEN 1 AND 2.";TAB(52);"\ ^ /"
3700 PRINT TAB(48);"5 ----- 1"
3710 PRINT "A 'WARP FACTOR' IS THE SIZE OF ONE QUADRANT.";TAB(52);"/ ^ \\"

3720 PRINT TAB(51);"/ ^ \\"
3730 PRINT TAB(50);"6 7 8"
3740 PRINT "COMMAND 1=LONG RANGE SCAN"
3750 PRINT "CODED IN THE FORM XXX, WHERE THE UNITS ARE THE NUMBER"
3760 PRINT "OF STARS, TENS THE NUMBER OF STARBASES, AND HUNDREDS"
3770 PRINT "THE NUMBER OF KLINGONS."
3780 PRINT LIN(2),"COMMAND 2=PHASERS"
3790 PRINT "YOU MAY DESTROY THE KLINGON BY USING ENOUGH PHASER"
3800 PRINT "POWER AS TO DEplete HIS SHIELDS. KEEP IN MIND THAT WHEN"
3810 PRINT "YOU FIRE AT HIM, HE GONNA DO IT TO YOU, TOO!"
3820 PRINT LIN(2),"COMMAND 3=PHOTON TORPEDOES"
3830 PRINT "COURSE IS SAME AS WITH WARP ENGINES. THE LIBRARY"
3840 PRINT "COMPUTER CAN COMPUTE TRAJECTORY FOR YOU (OPTION 1)"
3850 PRINT LIN(2),"COMMAND 4=SHIELDS"
3860 PRINT "DEFINES THE AMOUNT OF ENERGY TO BE ASSIGNED TO SHIELDS."
3870 PRINT LIN(2),"COMMAND 5=LIBRARY COMPUTER"
3880 PRINT " OPTION 0=DAMAGE REPORT"
3890 PRINT " A STATE OF REPAIR LESS THAN ZERO INDICATES THAT"
3900 PRINT " THAT DEVICE IS TEMPORARILY DISABLED."
3910 PRINT " OPTION 1=PHOTON TORPEDO DATA"
3920 PRINT " GIVES DIRECTION TO ALL KLINGONS IN YOUR QUADRANT."
3930 PRINT " OPTION 2=SHORT RANGE SCAN"
3940 PRINT " ALSO GIVEN AUTOMATICALLY AFTER SUCCESSFUL COMPLETION"
3950 PRINT " OF WARP ENGINE MANEUVERS."
3960 PRINT LIN(2),"COMMAND 6=RESIGNATION"
3970 PRINT LIN(6)
3980 GOTO 440
3990 END

```

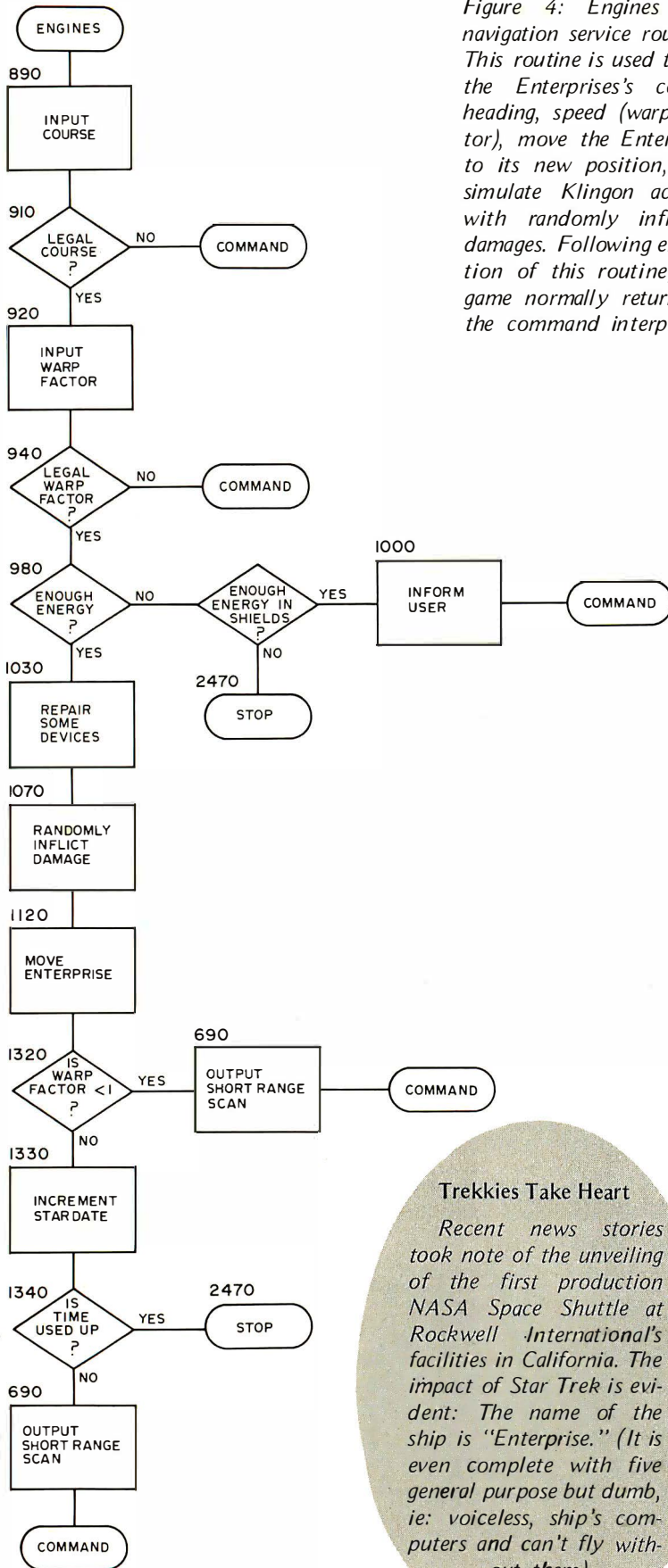
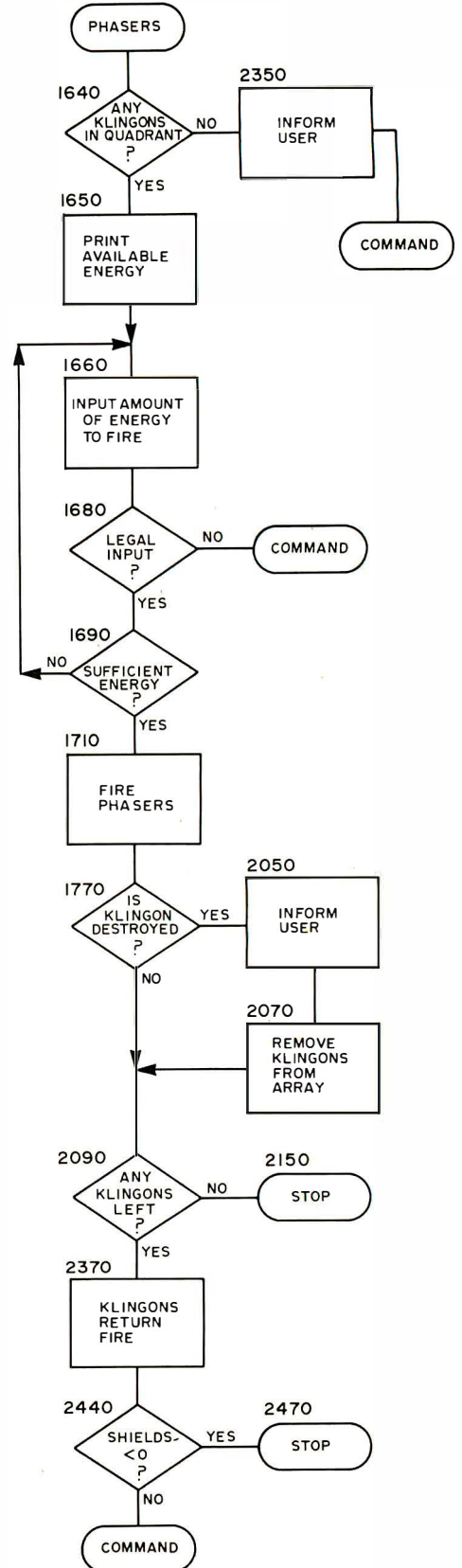

Figure 4: Engines and navigation service routine. This routine is used to set the Enterprises's course heading, speed (warp factor), move the Enterprise to its new position, and simulate Klingon actions with randomly inflicted damages. Following execution of this routine, the game normally returns to the command interpreter.

Figure 5: Phaser firing command service routine. The purpose of this routine is to fire the phaser, calculate damages to the Klingon ship (if any), and give the Klingon a chance to fire back with the effects of damage to the Enterprise computed.



Trekkies Take Heart
 Recent news stories took note of the unveiling of the first production NASA Space Shuttle at Rockwell International's facilities in California. The impact of Star Trek is evident: The name of the ship is "Enterprise." (It is even complete with five general purpose but dumb, ie: voiceless, ship's computers and can't fly without them).

between all of the Klingons in your quadrant. Thus, if you fire 600 units, and there are two Klingon ships, you are in effect firing 300 units at each one. Figure 5 shows the flowchart for the phaser firing sequence.

Command 3 is for firing the photon torpedoes. To fire torpedoes, you must first know the direction to your target. This, like the navigation course, is determined on the circular vector shown in figure 3. The library computer can compute the torpedo trajectory for you.

Often a star may be in your way, thus

Table 1: Some of the variables described by function. These variables have unique uses as described. Not all variables are listed in this table.

B3	=	The number of starbases in the current quadrant.
C\$	=	String containing the current condition: red, green, yellow, or docked.
E	=	Amount of energy remaining.
K3	=	The number of Klingon battle cruisers in the current quadrant.
K9	=	The total number of Klingon ships in the galaxy.
N	=	Three digit number stating number of Klingons, starbases, and stars in quadrant.
P	=	The number of photon torpedoes remaining.
S	=	Units of energy currently assigned to shields.
S3	=	The number of stars in the current quadrant.
T	=	The current stardate.
TO	=	The stardate on which the game began.
Q1,Q2	=	Specifies the X and Y coordinates of the current quadrant within the galaxy.
S1,S2	=	Specifies the location of the Enterprise within the quadrant.
D(1)...D(6)	=	Each element contains the state of repair for its respective device, (ie: D(3) contains data for device No. 3).
G(1,1)...G(8,8)	=	Each element is a three digit number containing data on a single quadrant of the galaxy.
Q(1,1)...Q(8,8)	=	Each element is a number 0 to 4, specifying what type of object is situated in that sector of the current quadrant.
K(1,1)...K(3,3)	=	Contains information on the Klingons in the current quadrant:
K(I,1)	=	The X coordinate of Klingon number I.
K(I,2)	=	The Y coordinate of Klingon number I.
K(I,3)	=	The shield power of Klingon number I.
FNA(X)	=	Returns a random number in a form useful to the program.
FND(O)	=	Returns the distance from the Enterprise to another Klingon.

preventing you from hitting your would-be victim. The only way around this, other than using phasers, which do not follow a pre-determined course and hence are not stopped by stars and other obstacles, is to use a small warp factor and maneuver in on the Klingon. Figure 6 shows the sequence that takes place when the photon torpedo command is initiated.

Command 4 allows you to raise or lower the Enterprise's deflector shields. It is neces-

Figure 6: Photon torpedo command service routine. This routine is entered when a photon torpedo is to be fired. It calculates the trajectory, examines the results for any Klingon hits, allows for Klingon return fire, then returns to the command routine if the Enterprise has survived.

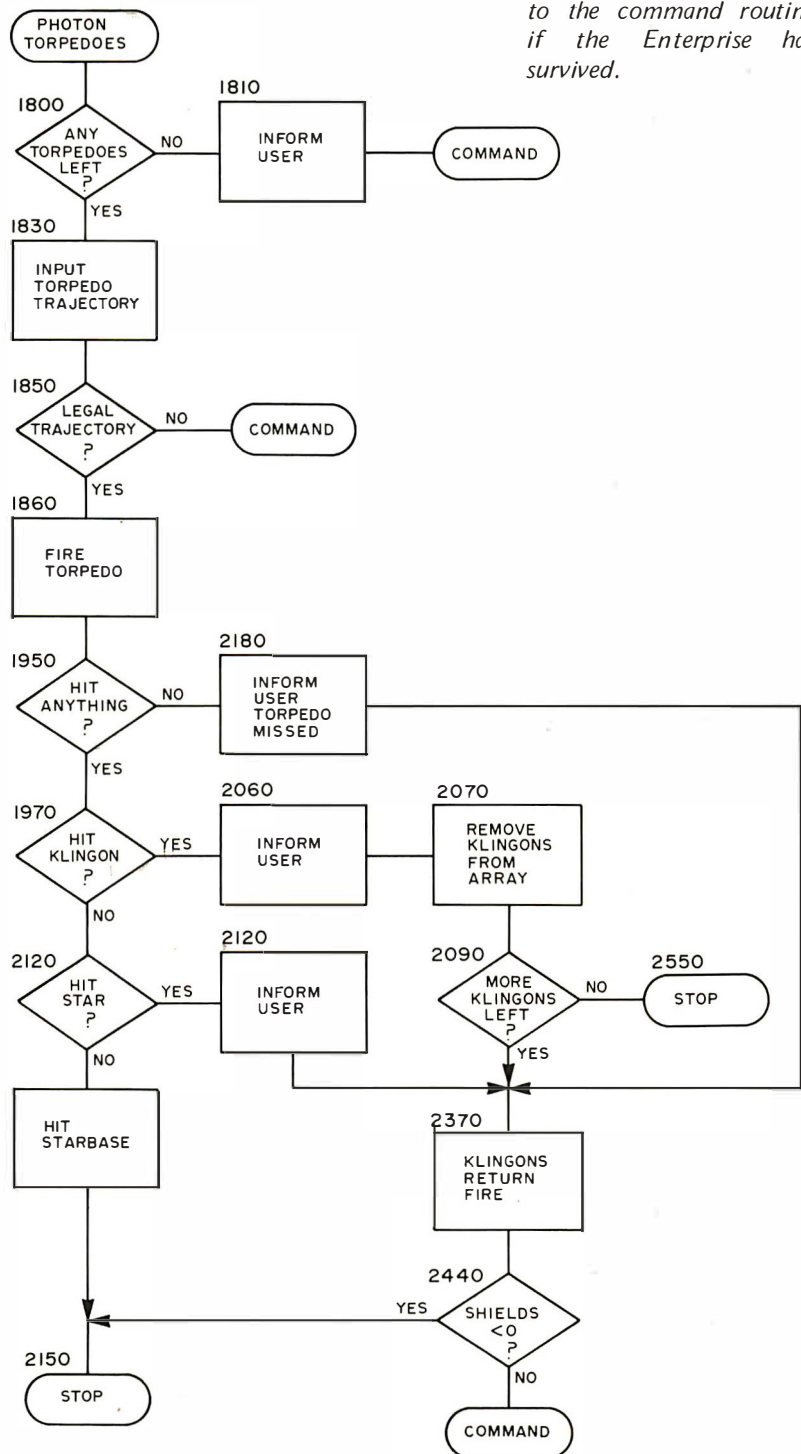

Command 5 allows the user access to the library computer which has three options specified by an integer between zero and two. If you enter an illegal option, such as a negative number, the computer will print a short list of commands.

Option 0 gives a damage report. The Enterprise may get damaged when you warp out at high speeds. When this occurs, you are informed as to which device has been affected. Extensive damage to a device may render it inoperable. In the damage report, each device is listed along with its respective state of repair. A state of repair less than zero indicates that the device is temporarily disabled.

Repairs are made, albeit slowly, by onboard technicians, but a faster way is to dock with a starbase. Not only does this automatically repair your ship, but you are also resupplied with energy and photon torpedoes. An extra bonus: While docked, you are protected from Klingon attack by the starbase's shields.

Option 1 calculates the torpedo trajectory to all Klingons in your quadrant. **Option 2** prints range scan. If you are docked with a starbase, it also replenishes your supplies.

Command 6 indicates that you wish to resign. Other good ways to end the game prematurely are to torpedo a starbase, or allow yourself to run out of energy.

Conversion Notes

As everybody knows, the growth of the personal computing field has been constantly hampered by the problem of standards. This has been particularly bothersome in the software agenda, where there are said to be no fewer than forty different versions of BASIC floating around. Consequently, I thought it would be appropriate to comment on some of the difficulties one might encounter in the conversion process.

Many BASICs have explicit matrix manipulation features. In particular I used MAT...ZER extensively. This statement initializes all the elements of a specified matrix to zero. It also allows the programmer to redimension the matrix.

LIN(X) appears in several places within the program. LIN is an output control function similar to TAB, which generates X number of linefeeds every time it is encountered.

GO TO...OF is replaced by ON...GO TO in many BASICs.

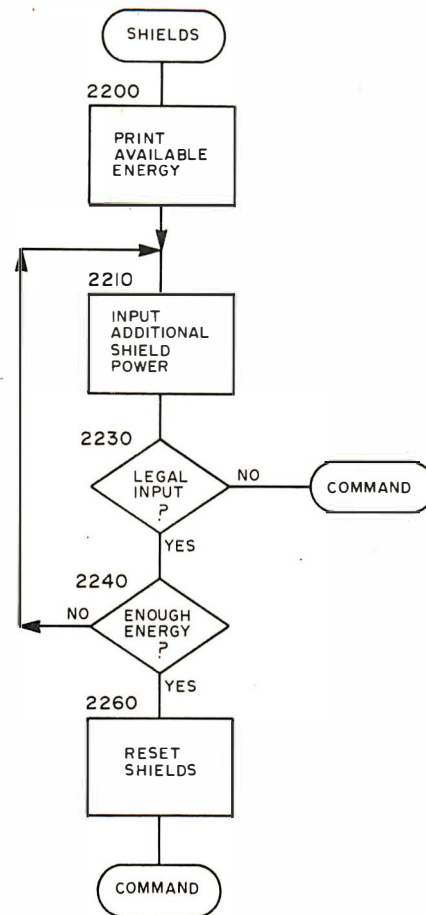

Figure 7: Shields service routine. This routine updates a power level for the Enterprises's shields.

Substrings in the form X\$(1,x) are replaced by the construct LEFT\$(X\$,x) in Altair BASIC. Also, Altair BASIC does not require that strings be dimensioned.

PRINT USING is used to format the long range scan. Output should appear in the following form: :xxx:yyy:zzz: The values of xxx, yyy, and zzz are the status reports concerning the number of Klingons, starbases and stars discussed under command 1.

The symbol # is used to express inequality within IF...THEN statements. Also, matrix subscripts are surrounded by brackets rather than parentheses. Near the beginning of the program, the sequence A=B=C=... is used to initialize many variables to the same value. This may produce unpredictable results on some machines.

The memory requirement of this particular version of Star Trek is 10 K bytes, plus interpreter. The program itself is 9382 bytes long. If your computer has an integer variables option, by all means use it. It can save you over 300 bytes on the matrices alone. If you are cramped you can also delete the instructions from the program. To do this, simply delete statement 350 and lines 3570 through 3980. ■

Positively Baker Street

Here is the solution to the "Baker Street Irregular" which appeared on page 86 of the February 1977 BYTE.

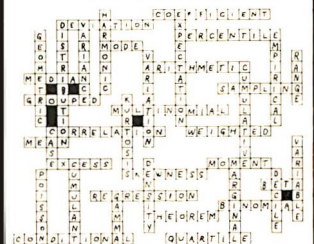

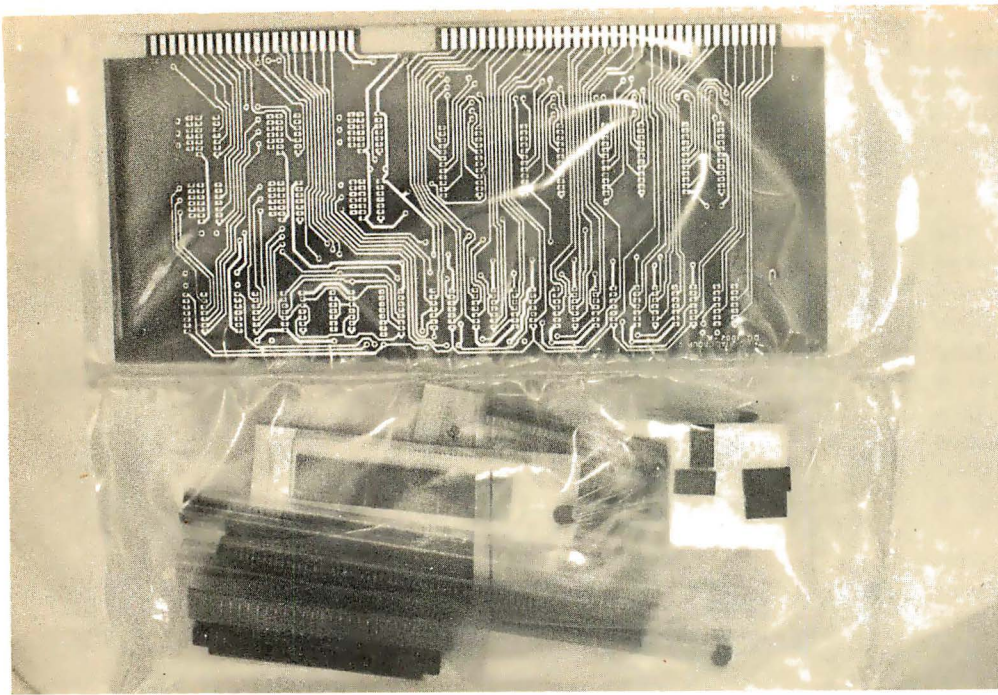

Photo 1: The typical board in a Digital Group kit comes in a sealed plastic bag with two compartments. One compartment contains the board and the second contains the necessary parts.

Steve Ciarcia
Box 582
Glastonbury CT 06033

Try This Computer on for Size

There are a number of fine micro-processor system kits available to the home computer enthusiast. One such system, which I just recently assembled, is the Digital Group 8080A. This microcomputer is marketed by the Digital Group in Denver CO. This concern, with Dr Robert Suding as its resident genius and designer, offers in my opinion the highest price performance of any home computer available. The Digital Group is somewhat unorthodox by not jumping on the bandwagon and being Altair bus compatible but their unit contains enough bells and whistles to placate even the most demanding computer owners.

This system, as is true of most others, has its good and bad points. I am an electrical engineer well versed in digital design and have been closely following the microcomputer scene since the advent of the MARK-8 in 1974. I have a Scelbi 8B and have helped friends build Altairs and IMSAIs from kits and feel that I can be completely objective. It is of course extremely difficult to restrain laudatory comments when one is so well satisfied, but bear with me.

The Digital Group sells a basic computer system which can contain one of four processor chips: the Zilog Z-80; AMD 8080A; MOSTEK 6800; or a MOS Technology 6502. I chose the 8080A because of a combination

of price and software availability. The Digital Group System (DGS) is generally sold as a three board system with mother board. This three board microcomputer has the following functions and specifications.

Processor Board

AMD 9080A
 2 K bytes programmable memory and EROM bootstrap loader.
 Direct Memory Access (DMA) logic.
 8 level hardware vectored interrupt.
 Buffered address and data bus lines.
 16 bit (64 K) addressing capability.

Input Output Board

Four 8 bit parallel input ports.
 Four 8 bit parallel latching output ports.
 Full 16 bit port addressing.

TV Readout and Cassette

Interface Board

Video Readout:
 Software controlled cursor.
 512 characters organized as 16 lines by 32 characters.
 7 by 9 character matrix.
 Full 128 ASCII character set.
 Upper and lower case alphabet.
 Math symbols.
 Special symbols.
 Greek alphabet.

Direct video output.

Cassette Interface:

Uses standard cassette recorder.

FSK recording technique.

Wide shift Teletype frequencies.

Operates at 1100 bps.

Utilizes "software UART."

An additional 8 K programmable memory board is added to the three board set and is sold to make a four board set. The specs on the programmable memory are as follows:

8 K Static RAM Board

Uses 2102-1 parts with
500 ns access time.

No wait states.

Buffered address lines.

Address decoding covers full
64 K range.

Power consumption 2 A at 5 V.

There are many variations of the basic system as described, and this listing is only representative of their total offering. Interested parties should contact the Digital Group at POB 6528, Denver CO 80206.

As I mentioned previously, I had been following the DG since they entered the microcomputer scene. Their first offering was a simple 300 bps "el cheapo" cassette interface which met absolutely nobody's standard. While everyone was arguing Kansas

City and all the rest, I built this for \$6 and had it operational in three hours. I have always been action oriented and all the talking in the world won't put your system on line. I have grown to expect and accept the unorthodox from the Digital Group.

Other manufacturers sell basic bare bones systems for prices starting around \$600. For this price they contain a fancy case and front panel, gigantic overkill power supply, and a processor board with ancillaries. There is no memory, IO, or mass storage capability: These are all extra cost options. Minimum capacity machine language and cassette storage system can approach \$800 to \$900. I affectionately refer to this nickel and diming as an "arm and a leg turnkey system."

The DGS is a profitmaking venture, I assure you; but it appears to have pricing and design philosophies which in my opinion better meet the needs and requirements of the knowledgeable experimenter.

When one buys a DGS three or four board system, you get Digital Group's version of the logically complete product: a system which in its basic price has no case, power supply or front panel. These are available from DG and can be purchased of course by the affluent or built from scratch by the frugal. Add a power supply, a video monitor salvaged from an old TV, a surplus

Photo 2: The author's Digital Group 8080 processor card. The actual processor is an AMD 9080A, one of the second sources of the original Intel 8080 design. The crystal which controls the processor clock is at the lower right, and the 2 K byte section of memory on the card is represented by the two rows of eight sockets at the left edge of the card. A UV erasable ROM chip (marked "80A" with a felt tip pen on the top edge at left of center) contains systems software which eliminates the need for a formal "blinkin' lights" front panel.

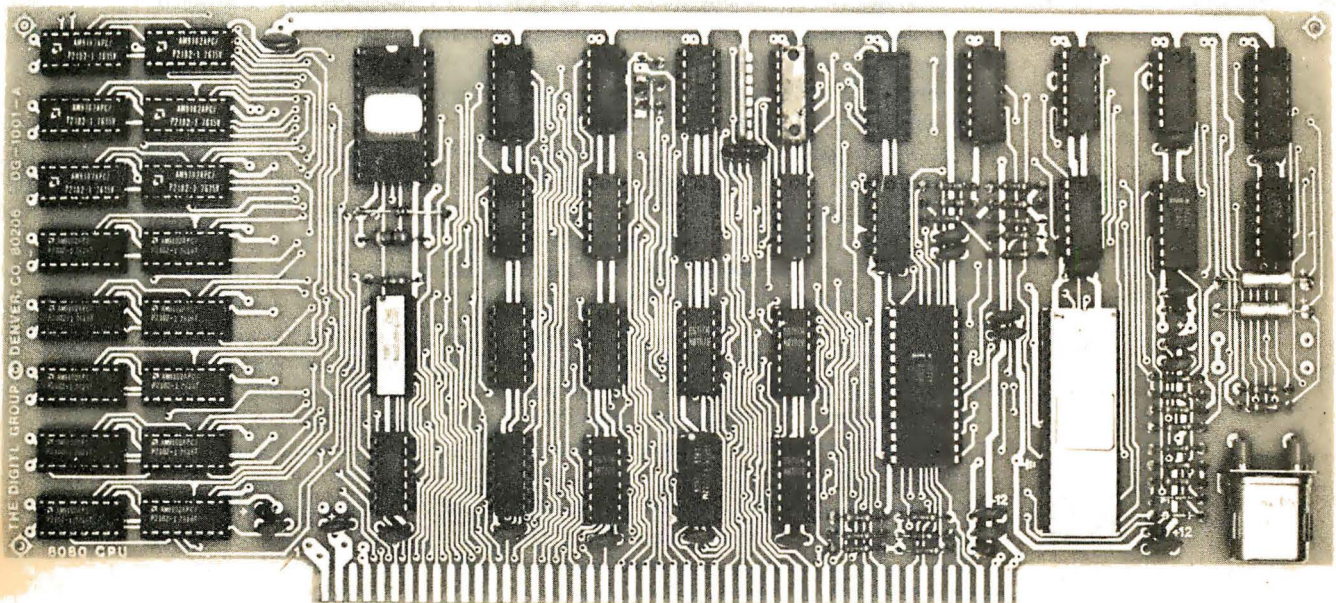

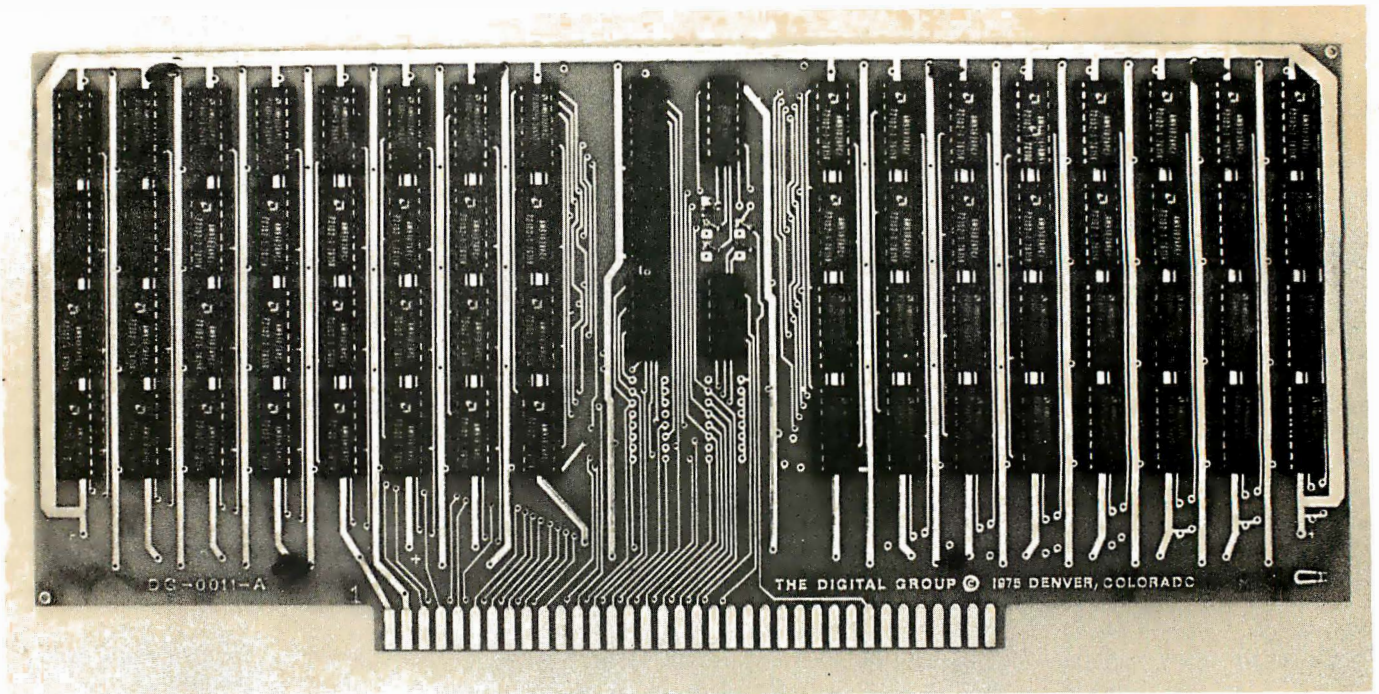

Photo 3: The author's Digital Group System 8 K byte memory card. The card contains 64 memory integrated circuits (in two arrayed segments) and in the center are various miscellaneous circuits used to interface the backplane bus of Digital Group system.

ASCII keyboard, and a decent cassette recorder; and you are in business with a complete functioning microcomputer.

I had been hearing this rhetoric and receiving DGS flyers for a while. Then I decided to take the plunge. I called DGS one morning in mid 1976 and ordered the four board 8080A system with standard mother board. Since this four board set contains 10 K bytes of programmable memory and is capable of supporting an Extended Tiny BASIC, I ordered the TBX software for \$5. The total 10 K system as ordered was \$645. Literature supplied by DGS quoted 30 day delivery but I had resigned myself to the possible two month wait that friends were experiencing with other companies. When the complete package arrived three weeks later I was ecstatic and set out immediately to the task of getting "on line."

The packing material, though sparse, was adequate; and, since there were no heavy components like transformers, its lack was inconsequential. Like any kit builder, I expected the first project would be to separate the pile of parts and boards and to sort components out among the respective boards. Anyone who has ever experienced sifting through a pile of resistors until their eyes cross can appreciate what I am saying. Fortunately this was unnecessary. Each board is packaged in a two compartment sealed plastic bag. One side contains the blank printed circuit board and the other

contains all the integrated circuits, sockets, and other components as seen in photo 1. When unpacking, two things are immediately apparent. The boards are top quality with plated through holes and there are no jumpers.

I searched through the box looking for the usual last minute revision sheets and tackons but there were none. This apparently was a final design with absolutely no "kluge rigging" necessary to make it work. The Digital Group flyers indicate they do not sell interim designs nor advertise anything for sale until it is available "off the shelf." From my experience, this appears to be the truth.

The ease of construction of this system is a function of the particular board being assembled. I'll cover each board separately, but a word of caution first. The Digital Group System is not and should not be considered in the same realm as a Heathkit or similar undertaking. Hardware documentation is adequate and descriptive but is not as detailed pictorially as a Heathkit. This is not a kit but rather an unassembled microcomputer. Its construction should be attempted by the experienced kit builder only. If necessary, build several difficult Heathkits first to gain experience with electronics components and assembly. At the least, difficult assemblies should be purchased as fully assembled and tested units and the other cards carefully constructed.

Building the Processor Board

The processor board is of course the heart of the microcomputer. This card contains the microprocessor itself and supporting components. It is shown (after I assembled it) in photo 2. The Digital Group has sought to learn from the experiences of other manufacturers and builders and has obviously benefited. The most notable addition is the incorporation of integrated circuit sockets throughout. Even with the use of prime components, bad circuits are possible. The average hobbyist may have considerable experience doing the initial soldering, but unsoldering an integrated circuit is quite messy. Using sockets adds the capability of quickly changing a suspected bad component without either destroying the integrated circuit or the printed circuit board.

Significant effort and thought has been put into this microcomputer design as is evident in the system architecture of the processor card. The microprocessor is driven by a crystal controlled clock which exhibits none of the frequency instability of multi-vibrator controlled clocks. Crystals are currently used in most microprocessor systems for their "rock like" stability. In addition, there is 2 K of programmable memory on the board which can be selected to respond to any two consecutive 1 K positions in memory address spaces. For startup and checkout, this memory should be set for 0 to 2 K allowing the user to perform limited machine language programming without additional memory. I'll cover the procedure for checkout a bit later.

There are of course other goodies on this card. Direct Memory Access (DMA) and priority interrupt hardware is provided as a user option. The basic three and four board systems include test procedures for the interrupt request logic but DMA checkout is

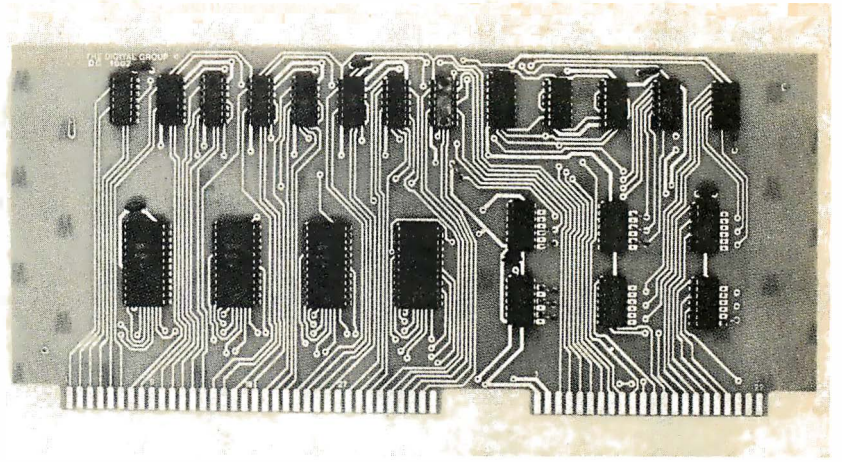

Photo 4: The author's Digital Group System IO card. This card interfaces to the system's bus, providing four parallel output ports and four input ports. These ports are routed to the backplane where they communicate to the video display, keyboard and cassette interfaces.

left for the brave of heart and is not addressed here. In addition to this circuitry, a 1702A EROM containing the tape cassette bootstrap loader is located in Page 0 of memory. When power is turned on, a power on reset signal initializes the system and reads in the operating system cassette. More on this later.

The Digital Group System bus structure is similar but differs in detail from that of the Altair. Robert Suding's publicized philosophy dictates an interchangeable processor capability which hopefully decreases the obsolescence of the total system. As new and more powerful microprocessors such as the Z-80 come on the market, a new processor card should be interchanged with the bus of the older unit while not affecting the rest of the system. To accomplish this goal, the Digital Group system uses unidirectional address and data buses as in the

QUALITY support for HARDWARE BUFFS



LEARN HOW MIXED LOGIC CAN SIMPLIFY THE DESIGN OF GATE CIRCUITS AND MAKE LOGIC DIAGRAMS EASIER TO UNDERSTAND.

SEE HOW FLOW CHART DRIVEN DESIGN CAN HELP YOU DESIGN INTERFACES, CPU'S, AND SPECIAL LOGIC.

LD14 LOGIC DESIGN SUPPORT SYSTEM

\$1095

LOGIC DESIGN, INC.

BOX 3991 UNIVERSITY STATION

LARAMIE, WYO. 82071

307 742-7977

(See Jan Byte or send for brochure)

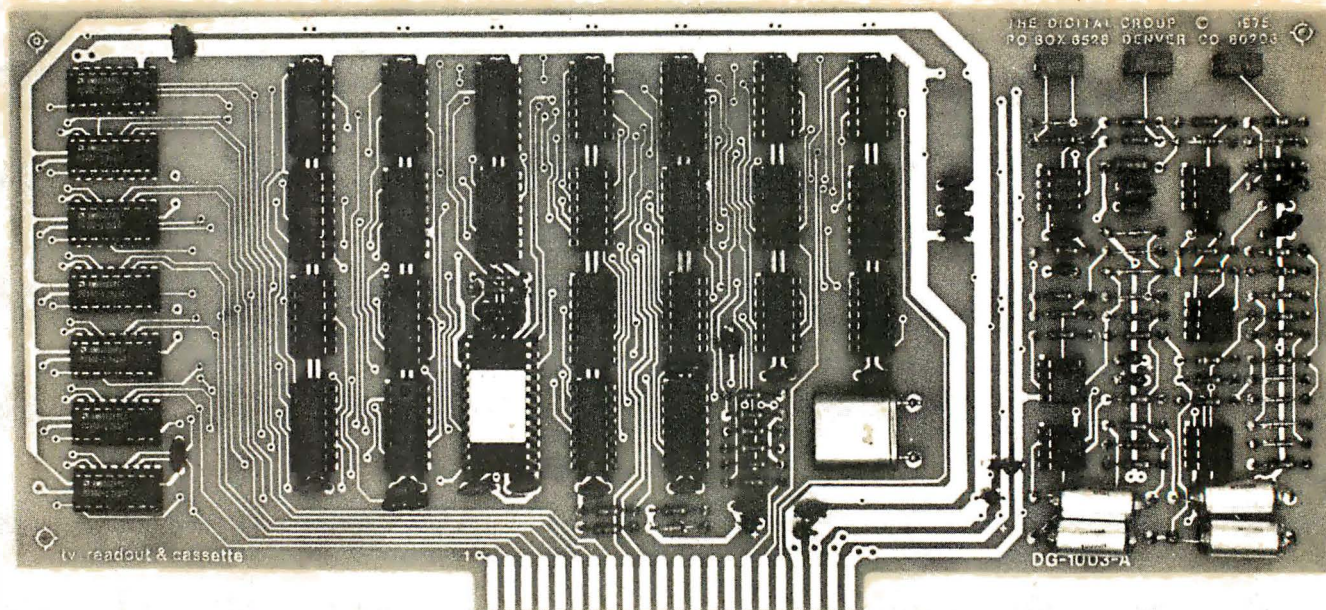

Photo 5: The cassette and CRT interface board. This board contains the video signal generation and audio processing circuits of the Digital Group System. [For more detailed descriptions, see the July and August 1976 issues of BYTE.]

Altair. Such a bus structure, as has often been seen in the marketplace, is easily adapted to any 8 bit processor. There is of course a basic disadvantage to owning a unique backplane pinout, that of having only a single source. Every microprocessor manufacturer knows that few designers will tie themselves to a single source part. That is the reason you see so many different companies producing 8080s. The Altair bus has been widely second sourced, which has led to some fierce competition resulting in modest benefits to the buyer. Obviously the small system owner does not have the same constraints as the high volume manufacturer but he should be aware of the lack of price competition and interchangeability when it comes to memory and IO card expansion. The Digital Group is apparently aware of their unique position and has sought to dispell concern by selling blank IO and 8 K memory boards at a very reasonable price. This allows the user to shop around for the best 2102-1 memory prices.

Since the DGS has no front panel, the processor card cannot be checked out easily by itself. But then no real functional test of a processor system as a whole can be easily performed with a front panel, either. The rest of the system must be constructed to perform the necessary diagnostics.

Assembling the Memory and IO Boards

Both the 8 K memory and parallel IO boards are constructed in a very straightforward manner. Again all integrated circuits are socketed and literature supplied is both

explicit and clear. The memory board (see photo 3) and components supplied to me contained premium grade AMD 2102-1 parts. With these parts no wait states are required and the processor runs at full rated speed.

The IO card which contains four parallel inputs and four latched parallel outputs must be set to the lowest order addresses when only one IO board is in the system. This is because the video display generator, keyboard and cassette interface are directly wired to IO ports on this card through the mother board. The ports are address selectable; but to utilize the DGS operating system software, the addresses must be set as described in the DGS write up. Additional memories or IO can have addresses to suit the user.

Assembling the Cassette and CRT Interface Board

This board is the external communications medium of the Digital Group micro-computer. Since the DGS has no front panel, it is solely dependent upon a video based operating system utilizing the video display generator interface and a television monitor, or modified television. The software for such an operating system is about 1.5 K and cannot be entered except through the cassette interface. I should clarify one thing though. The DGS which I purchased is quite amenable to front panel hookup. The three and four board units sold by the Digital Group do not incorporate front panels but they do provide a design for one. Obviously,

if a user builds a DG system and both his processor and video display sections fail to function properly, he is dead in the water and would have to build the front panel. The design is neat and functional and plugs into any spare memory card slot. If, on the other hand, the user is thoroughly frustrated, suspect boards can be returned to DG for troubleshooting according to a price schedule supplied with the unit.

Now that you know how to get yourself out of the hole if it happens, I'll explain the proper method of digging.

The CRT and cassette interface sections are assembled using the same methodical approach as the other boards. The literature is very good in this respect. The problems come in calibration. The CRT is fairly straightforward, it either works or it doesn't. There are no adjustments. This section, when completed, is plugged into the mother board, attached to a monitor, jumpered as per the testing procedure, and powered up. If it works the screen will be immediately filled with 512 random characters. These characters include upper and lower case alpha symbols, and Greek lettering. When this works you are half done with the check out of the card.

Being half done in this case is not nearly enough. The assembly of the cassette interface is simply a matter of following directions but calibrating it is a bit of a task. There are operating system options which allow the computer to function as a frequency counter, but that is a little further downstream. To properly adjust the cassette interface, a scope, a frequency counter, an accurate DC voltmeter or DVM and a variable frequency oscillator are required. I fortunately have all this equipment, but not everyone's spouse is as understanding as mine. The frequency source is set to 1 V p to p at 2125 Hz and applied to the inter-



Photo 6: When you get this far, you know your Digital Group System has arrived in the land of the living.

face input, simulating the tape recorder output. Using a scope to determine the point of peak response, the active filters are adjusted correspondingly. This procedure is repeated for 2975 Hz. Next the comparator which detects whether the input frequency is at a mark or zero is adjusted to switch cleanly as the frequency source sweeps between the two valves. That takes care of the receiver sections.

The FSK (frequency shift keyed) modulator is a single VCO (voltage controlled oscillator) chip which switches between two frequency values corresponding to TTL one or zero inputs. In initial checkout, a voltage (3.5 V) simulating a TTL level one is applied to the control line of the oscillator and the output is adjusted to 2125 Hz. The control line is then grounded and the output adjusted to 2975 Hz. If this can be accomplished satisfactorily, you're in business.

System Checkout

When all of the cards are assembled, and the solder splashes cleaned off, take one last look at each card. Remember, this is the smoke test.

Attach the power supply to the mother board and with no boards inserted and the power on, check that the proper voltages are present. Shut off the supply and insert the

LET YOUR



COMPUTER SEE!

T.V. CAMERA & DISPLAY INTERFACES FOR ALTAIR/IMSAI

●PLAY GAMES & LET YOUR COMPUTER SEE THE BOARD

●TEACH YOUR COMPUTER TO READ, DO SURVEILLANCE, ETC.

●LET YOUR COMPUTER MAKE DECISIONS BASED ON VISUAL INPUT

	INTERFACE I T.V. Camera to Computer	INTERFACE II Computer to Monitor
Maximum Vertical Resolution	240	120
Maximum Horizontal Resolution	215	107
Grey Scale Resolution	64	16 to 64
Maximum Conversion Time (Sec.)	5	—

Any T.V. Camera with external sync. input can be used. Memory requirements-4K to 64K RAM. **INTERFACE III:** Computer to Oscilloscope - 4096 points are displayable in any programmable array. Includes 4K 450ns static RAM usable by Oscilloscope or Computer.

All equipment fully assembled and documented. Allow up to 90 days for delivery.

Mail checks or money orders to **ENVIRONMENTAL INTERFACES**
3207 Meadowbrook Blvd. Cleveland, Ohio 44118 (216) 371-8482

<input type="checkbox"/> INTERFACE I	\$295
<input type="checkbox"/> INTERFACE I and T.V. Camera	595
<input type="checkbox"/> INTERFACE II (excludes monitor)	245
<input type="checkbox"/> INTERFACE III and RAM	495
<input type="checkbox"/> 12" T.V./MONITOR COMBINATION	150
<input type="checkbox"/> SEND MORE INFO.	

Enclosed is my check/money order for: \$ _____

Name: _____

Address: _____

City: _____ State _____ Zip _____

Ohio residents please add 5.5% sales tax, thank you.

processor, IO and CRT cards. Cross your fingers and turn on the power. If all works correctly, the screen will display: "READ 8080 INITIALIZE CASSETTE". Successfully accomplishing this means that the processor is operating correctly, the CRT board works fine and at least part of the IO board is functioning.

The acid test is loading the operating system via the cassette interface. (To facilitate this endeavor and add more ease of operation, a Reset/Run button should be wired to the mother board as described in the DG literature.) With this message present on the screen, insert the 8080 operating system cassette and hit the play button. Adjust the output level to be about 1 V p to p and soon a leader tone should be heard. No change should appear on the screen. Immediately following the tone will be the asynchronous data at 1100 bps. Proper reception of this data will be evident on the video display. As each byte of data is processed and loaded into memory, it is read from memory to verify that it got there. If it loaded correctly, a number corresponding to the high order digit of the octal page address of this byte location is printed on the screen. With 256 bytes per page, there will be 256 number 1s, 256 number 2s, etc, until the tape is loaded. Should the memory

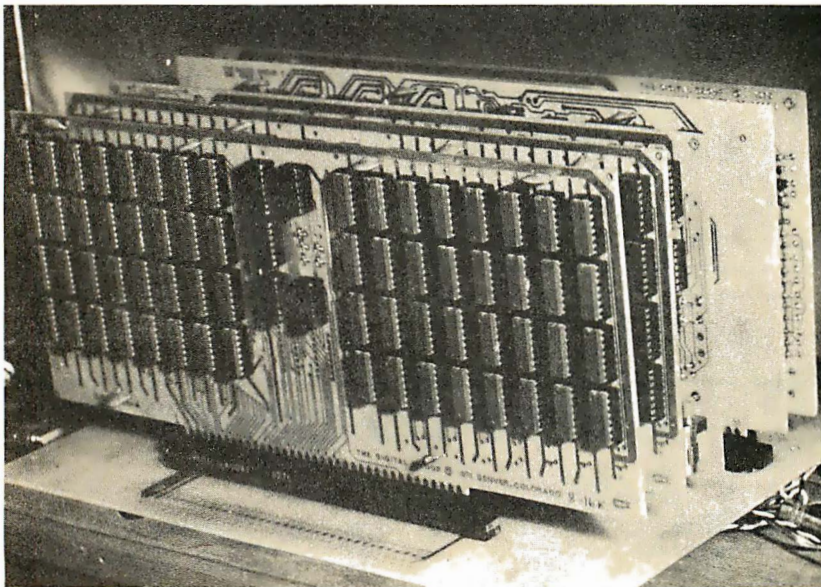

Photo 7: A view of Steve's assembled Digital Group System. [When a party from the BYTE office stopped by at Steve's basement laboratory in Connecticut on the way back from Atlantic City last fall, we found his system up and running as pictured here, with his older Scelbi 8B computer acting as a slave peripheral processor to control the vector graphics output device described on page 78 of the November 1976 BYTE. Steve cooked an excellent Quiche Lorraine for dinner that night while Dan Fylstra and I explored a game of KINGDOM running in Tiny BASIC . . . CH]

check signify a bad byte, a period (".") will be displayed instead of the octal number. It's a good idea to watch the screen while the cassette is being read.

If the cassette was read in properly, the computer will display the operating system options on the screen as in photo 6. If not, try again. Be careful to watch that there are no numbers, signifying received data bytes, on the screen prior to the playback of the actual data on the tape. Should this occur due to a noise glitch, hit the reset, and it will clear this problem.

The DGS operating system requires that alphanumeric information be input on a parallel 8 bit input port in the form of ASCII. All this means is that you need a keyboard. The ASCII is 7 bits of the input port and the eighth bit corresponds to the key pressed or strobe signal. The operating system scans this bit looking for a transition from a zero to a one so therefore it must be a positive going strobe (TTL level) with a minimum duration of 50 μ s. I have a surplus Sanders Associates 720 keyboard which a lot of people have. This keyboard has a 5 μ s negative going strobe though and must be modified by adding a oneshot such as a 74121 to it. Since the whole keyboard runs on 5 V, this is an easy conversion and the keyboard is an exceptional buy. With keyboard and monitor, the system is totally operational. If you were able to get the operating system option list which appears in photo 6, you are ready to go. Hit 3 and the screen displays the contents of all the registers and flags. Hit space and you'll start to page through memory displaying all memory contents. Return to the operating system and hit option 4 and the keyboard can be used to enter octal machine language code anywhere the user desires. The complete explanation is included with operating system tape.

Where the Digital Group System really shines is the cheap software and system simplicity. Add the 8 K memory board, set the address for 0 to 8 K and reset the processor 2 K memory to occupy 8 K to 10 K and we are ready to run Extended Tiny BASIC.

With 10 K of memory installed, turn the system on and start the 10 K Tiny BASIC tape as you would the operating system tape. After a few minutes the tape will have been read and the system will display the Tiny BASIC options:

TINY BASIC

1. READ BASIC PROGRAM
2. WRITE BASIC PROGRAM
3. DISPLAY COMMANDS

4. DISPLAY ERROR CODES
5. CONTINUE PROGRAMMING
6. TINY BASIC

With these options, an Extended Tiny BASIC, created by Dick Whipple and John Arnold and described in the January 1976 issue of *Dr Dobb's Journal of Computer Calisthenics and Orthodontia*, is ready to go. Buy a couple of simple programs such as Blackjack, Bantum and others from the Digital Group Software Systems, and you can utilize the computer immediately to entertain the whole family or bone up on Tiny BASIC and write your own programs.

Observations and Criticisms

As stated earlier, it is my opinion that the Digital Group System is one of the best offerings on the small systems market today. But as previously mentioned, anyone not having the proper equipment should not attempt to assemble the CRT and audio cassette interface. After receiving my system, I was up and running with the 2K processor card memory with two evenings' work. Since I had the equipment and am very receptive to logical well written instructions, I had no troubles. My cassette interface didn't work at first, and I discovered that it was because of insufficient tape recorder bandpass. I had hoped to use the same el cheapo recorder that I used for my previous 300 bps interface, but no way. I rushed out and spent a whopping \$39 for a new one from J C Penney which had been suggested by another Digital Group System owner. The first time I hit play, it worked perfectly. Since that time, I have discovered that the cassette interface is sensitive to both volume and tone settings during playback. This is probably only a function of the tape recorder I own and is not necessarily indicative of a general problem. Using a quality cassette recorder of the type suggested by the Digital Group should eliminate any playback problems.

Recording a program on tape is simply a matter of choosing the correct operating system option but getting accurate mark and zero frequencies may require minor tweeking. There appears to be some shift in the output frequencies from the time of the static calibration and actual dynamic operation. This is obviously due to the fact that 3.5 VDC and 0 V are not the actual TTL levels applied to the voltage controlled oscillator. A VCO is an analog device and not all TTL chips are exactly alike. After reading in the operating system tape I

Continued on page 129

Confused About Printers?

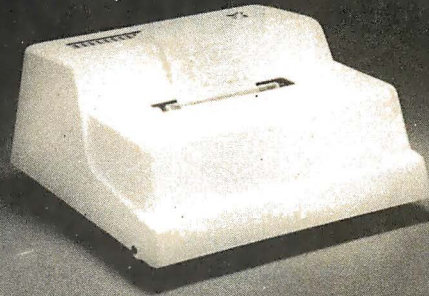

MPI HAS YOUR ANSWER!

TTY REPLACEMENT? THE SSP-40 **\$575**

The SSP-40 contains its own microprocessor for easy connection to your serial port.

LOW COST BUSINESS SYSTEM? THE MP-40 **\$425**

The MP-40 connects to your parallel port for ASC11 data transfer.

MINIMUM COST FOR HOBBYIST? ... THE KP-40 KIT **\$179**

The KP-40 KIT contains mechanism and minimum electronics for connection to your parallel port.

All of our 40 series printers use the same reliable 5x7 impact dot matrix mechanism with up to 40 columns per line on ordinary paper with a print speed of 75 lines/minute.

MASTER CHARGE WELCOME • UTAH RESIDENTS ADD 5% SALES TAX

mpi

SEND FOR FREE LITERATURE

MICROPROCESSOR SYSTEMS AND PERIPHERALS
P.O. BOX 22101/SALT LAKE CITY/UT. 84122
(801) 566-0201

THE PROM SETTER WRITE and READ EPROM

1702A and 2708

- Plugs Directly into your ALTAIR/IMSAI Computer
- Includes Main Module Board and External EPROM Socket Unit
- The EPROM Socket Unit is connected to the Computer through a 25 Pin Connector
- Programming is accomplished by the Computer
- Just Read in the Program to be Written on the EPROM into your Processor and let the Computer do the rest.
- Use Socket Unit to Read EPROM's Contents into your Computer
- Software included
- No External Power Supplies, Your Computer does it all
- Programs and Reads Both 1702A and 2708 EPROMS
- Doubles as an Eight Bit Parallel I/O
- Manual included

INTRODUCTRY OFFER*

Kit Complete — \$135 (Normal Price \$165)

Assembled — \$245 (Normal Price \$275)

*Special Price Good Only Until March 31, 1977

Delivery Less than 90 days

SZERLIP ENTERPRISES

1414 W. 259th St. — Harbor City, California 90710

California residents please add 6% sales tax

Multiplex Your Digital LED Displays

James Hogenson
 Box 295
 Halstad MN 56548

Digital LED displays were once a novelty to the hobbyist, a luxury found in expensive lab equipment. They are now a household word and a useful tool for the digital experimenter. A digital LED display can be used as the readout for almost any test instrument. A programmable LED display can be used as a computer output. A digital

LED display is a handy replacement for the binary lights on a computer control panel. If you have been thinking about using an LED display for any of these or other reasons, this article may save you some time, money, and power.

There are two methods which may be used to drive an LED display. The direct

Figure 1: Circuit diagram of a simple multiplexed 8 digit display for BCD or octal data. The printed circuit layout of this version is depicted in figure 3. Figure 5 shows the printed circuit used to mount the displays.

Integrated Circuit Summary List

	Type	POWER +5 V	PINS GND
IC1	7493	5	10
IC2	74151	16	8
IC3	74151	16	8
IC4	74151	16	8
IC5	74151	16	8
IC6	7448	16	8
IC7	75451	8	4
IC8	75451	8	4
IC9	75451	8	4
IC10	75451	8	4
IC11	74155	16	8
IC12	555	See figure 1	

NOTE: 8 MAN 4 or DL704 seven segment LED displays are required.

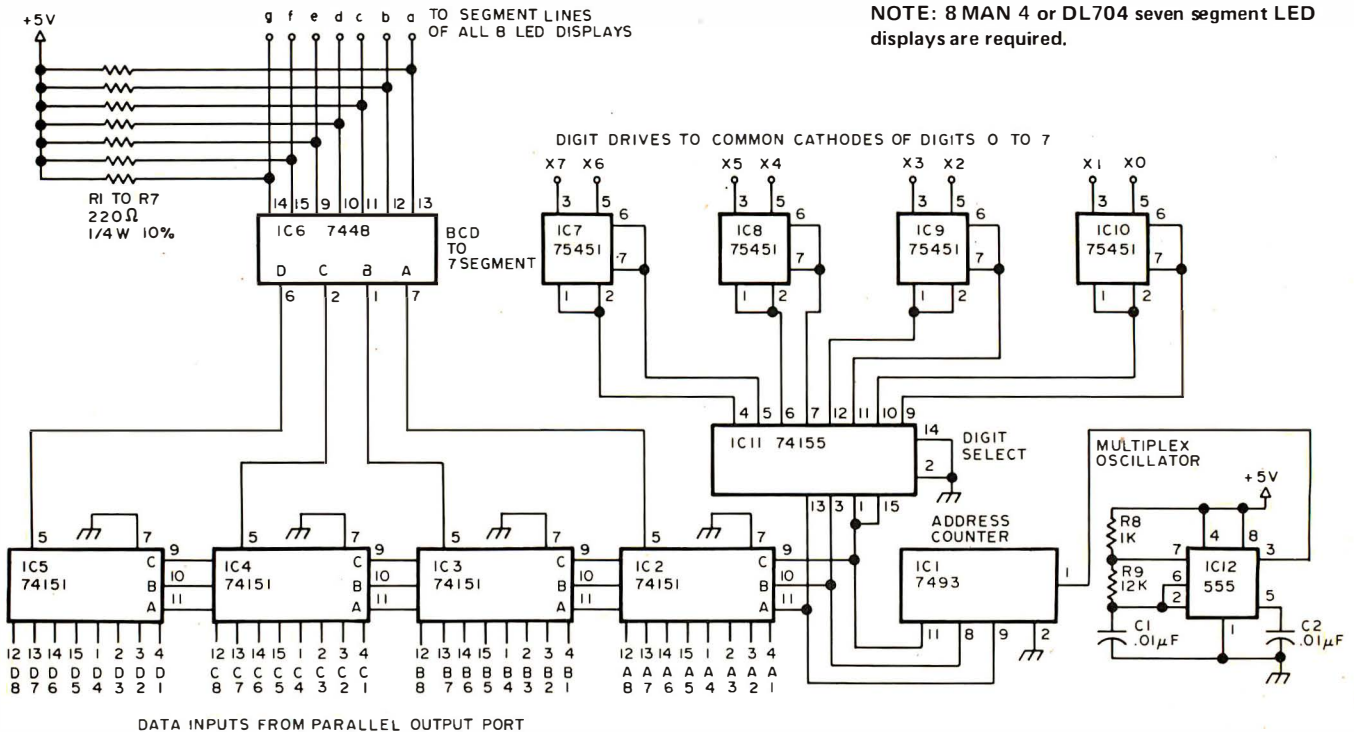

power configuration uses one 7 segment driver for each 7 segment LED in the display. Constant power is supplied to all digits. The multiplexed configuration uses only one 7 segment driver for several digits. Power is supplied to only one digit at a time, but is switched at a high rate so all digits appear to be on constantly. Since only one digit is powered at any given time, a certain amount of power is saved. This principle is widely used in electronic calculators.

The circuit of figure 1 is the driver circuit for an 8 digit multiplexed LED display. This circuit will display 8 digits of parallel BCD

data. All data inputs are connected to a multiplexer. There is one 8 channel multiplexer for each of the 4 data input bits. The least significant bit of each digit is connected to an input of IC2; the most significant bit of each digit is connected to an input of IC5, etc. The multiplexers and demultiplexer are addressed by the 7493 counter which is incremented at approximately 4 kHz by the 555 oscillator. IC11 is connected for 3 to 8 line demultiplexing. When the selected output line of the demultiplexer goes to a low state, one of the peripheral interface gates is enabled. IC7 through IC10 are dual peri-

Integrated Circuit Summary List

Type	POWER +5 V	PINS GND
IC1	555	See figure 2
IC2	74123	16
IC3	74193	16
IC4	7489	16
IC5	7404	14
IC6	7448	16
IC7	75451	8
IC8	75451	8
IC9	75451	8
IC10	75451	8
IC11	75451	8
IC12	75451	8
IC13	75451	8
IC14	75451	8
IC15	74154	24

NOTE: 16 MAN 4 or DL704 seven segment LED displays are required.

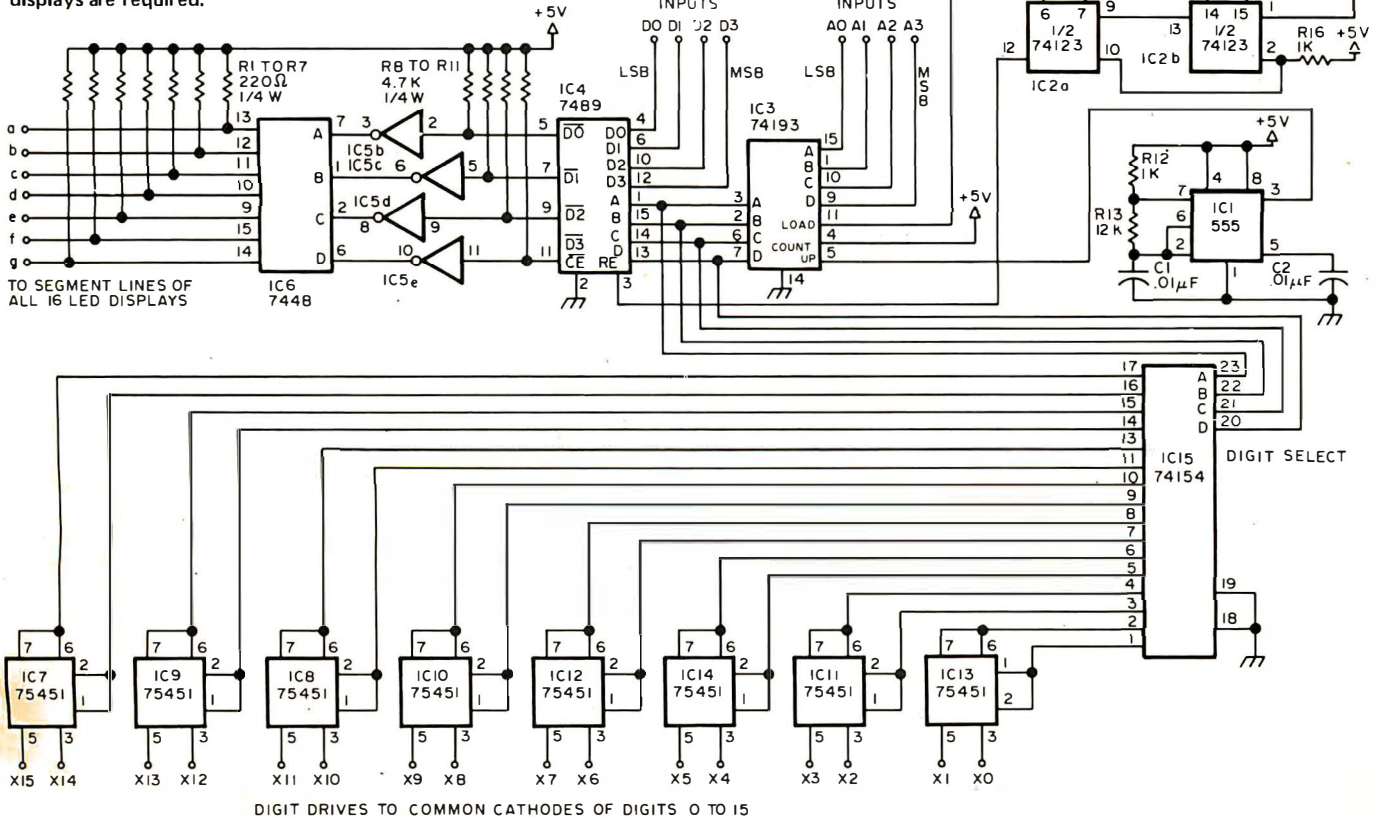
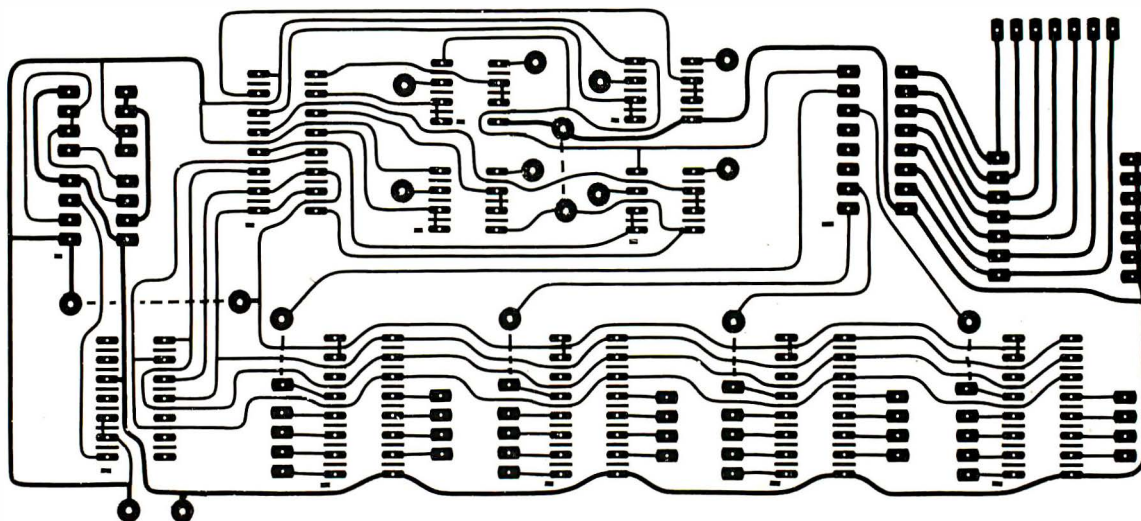

Figure 2: Circuit diagram of a digit-serial multiplexed 16 digit display with memory. The printed circuit layout of this version is depicted in figure 4. Figure 5 shows the printed circuit (two copies required) used to mount the displays.

Figure 3a: Printed circuit pattern (foil side) of the 8 digit display circuit.



peripheral interface gates. Each gate is capable of sinking a current of up to 300 mA. When a digit is selected, the interface gate provides a ground path for the common cathode of the 7 segment LED. Only the LED whose

cathode is grounded will light up. Although the same data will be present at all digits, the data will be displayed by only one digit. By changing the data present and switching the enabled digit, each digit will display its own data. A 7448 decoder/driver converts the BCD data to a 7 segment code and drives the individual segments of the LEDs. The segments of all 8 digits in the display are connected in parallel.

The circuit of figure 2 is a 16 digit programmable display. This circuit will memorize and display the data presented at its inputs one digit at a time. The size of the demultiplexer and the number of peripheral interface gates is doubled, since the programmable display has 16 digits. The input multiplexer is replaced by a memory which is loaded digit by digit. The 7489 TTL RAM, IC4, is very conveniently arranged for a 16 digit BCD memory. The RAM outputs are, however, inverted open collector outputs, so pullup resistors and inverters (IC5b to IC5e) are needed.

The counter used is a 74193 presettable binary counter, IC3. A 555 oscillator (IC1) drives the counter at 4 kHz. A digit is selected for programming by setting the memory address at the inputs of the counter. An external clock pulse at the clock input will program that digit. It is assumed the external clock pulse will be at least 200 ns. When the clock pulse input line goes low,

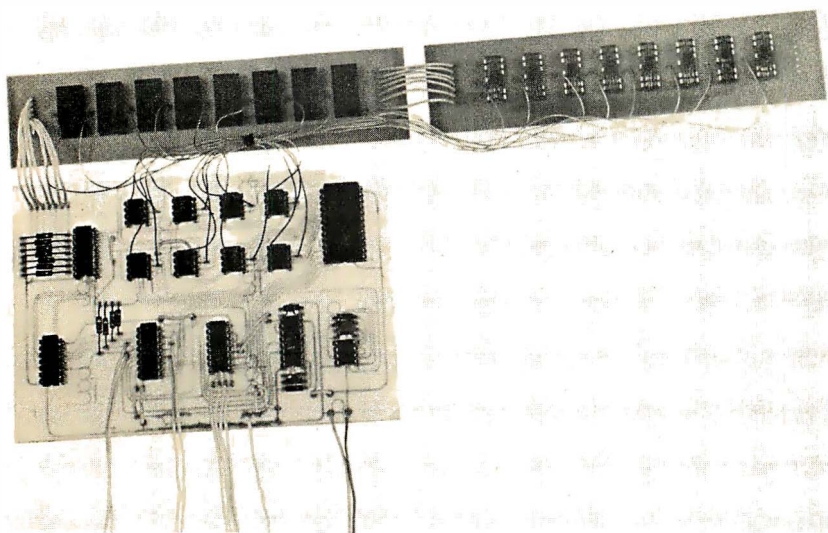
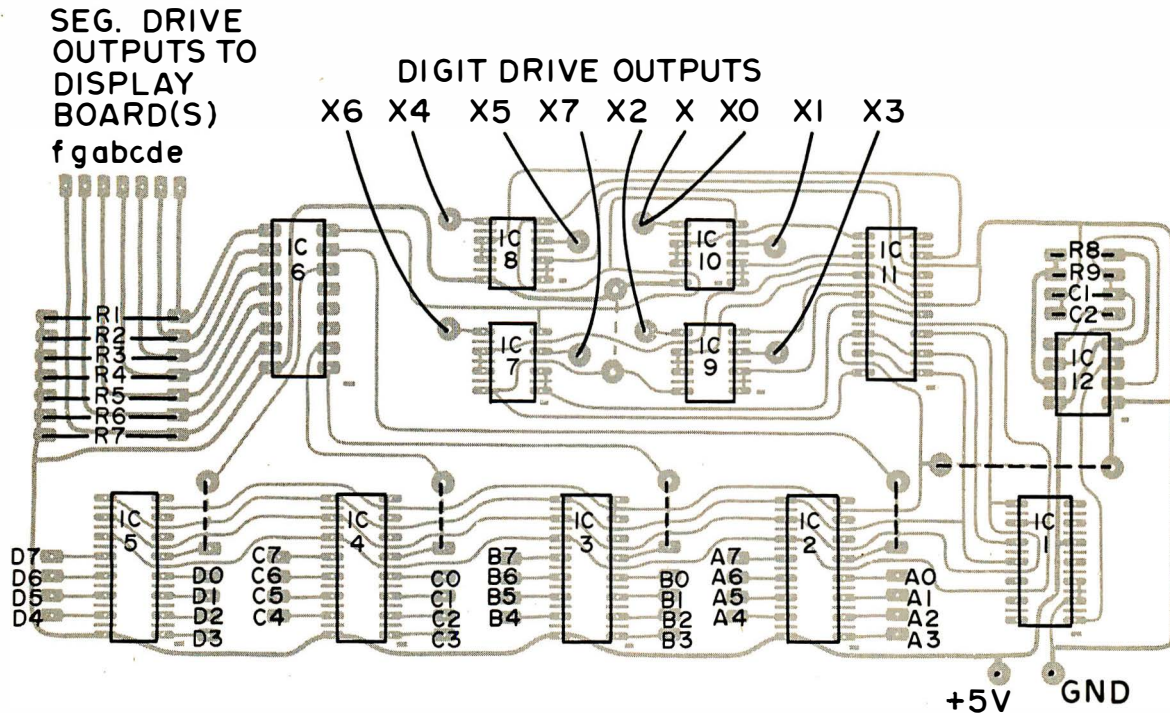

Photo 1: A 16 digit BCD assembly constructed using the circuit of figure 2, with the printed circuit layouts of figures 3 and 5. The 16 digit memory display requires two copies of the LED mounting board, with jumpers connecting the segment lines from one board to the next. Power, data and address inputs are shown trailing away at the bottom.

Figure 3b: Printed circuit component side map of the 8 digit display. See figure 1 for identification of components. Jumper wires are shown as dotted lines in the overlay.



the counter will be disabled and the address on the counter inputs will appear at the outputs addressing the memory. IC2 provides a 60 ns delay, then a 60 ns pulse which writes the data at the memory data inputs into the memory location addressed. When the clock line returns to the high state, the counter will resume counting. The counter sequentially addresses the BCD data stored in the memory while it selects and enables the appropriate digit in the display.

Single layer printed circuit patterns are provided for readers who make their own boards. The inputs on the simple multiplexed driver board (figure 1 schematic, figure 3 printed circuit layout) are connected as follows: Bit 0 of the first digit to input A0, bit 1 to input B0, bit 2 to input C0, bit 3 to input D0, bit 0 of the second digit to input A1, bit 1 to input B1, etc. The segment outputs (a to g) should be connected to the display board (see figure 5b) at the pads provided on either end of the board. The digit (common cathode) driver outputs (X0 to X7) should be connected to pin 4 of their respective digits.

Output connections for the 16 digit programmable display driver board (figure 2 schematic, figure 4 printed circuit layout) are the same as for the self scanning board. Referring to the component placement diagram, connect the BCD data input directly to the D₀, D₁, D₂, and D₃ lines of IC4. The

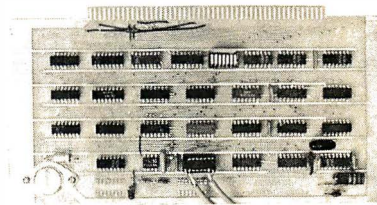

The Tarbell Cassette Interface

- Plugs directly into your IMSAI or ALTAIR
- Fastest transfer rate: 187 (standard) to 540 bytes/second
- Extremely Reliable—Phase encoded (self-clocking)
- 4 Extra Status Lines, 4 Extra Control Lines
- 25-page manual included
- Device Code Selectable by DIP-switch
- Capable of Generating BYTE/LANCASTER tapes also.
- No modification required on audio cassette recorder
- Complete kit \$120, Assembled \$175, Manual \$4

TARBELL ELECTRONICS

144 Miraleste Drive #106, Miraleste, Calif. 90732
(213) 832-0182

California residents please add 6% sales tax

Figure 4a: Printed circuit pattern (foil side) of the 16 digit memory display circuit.

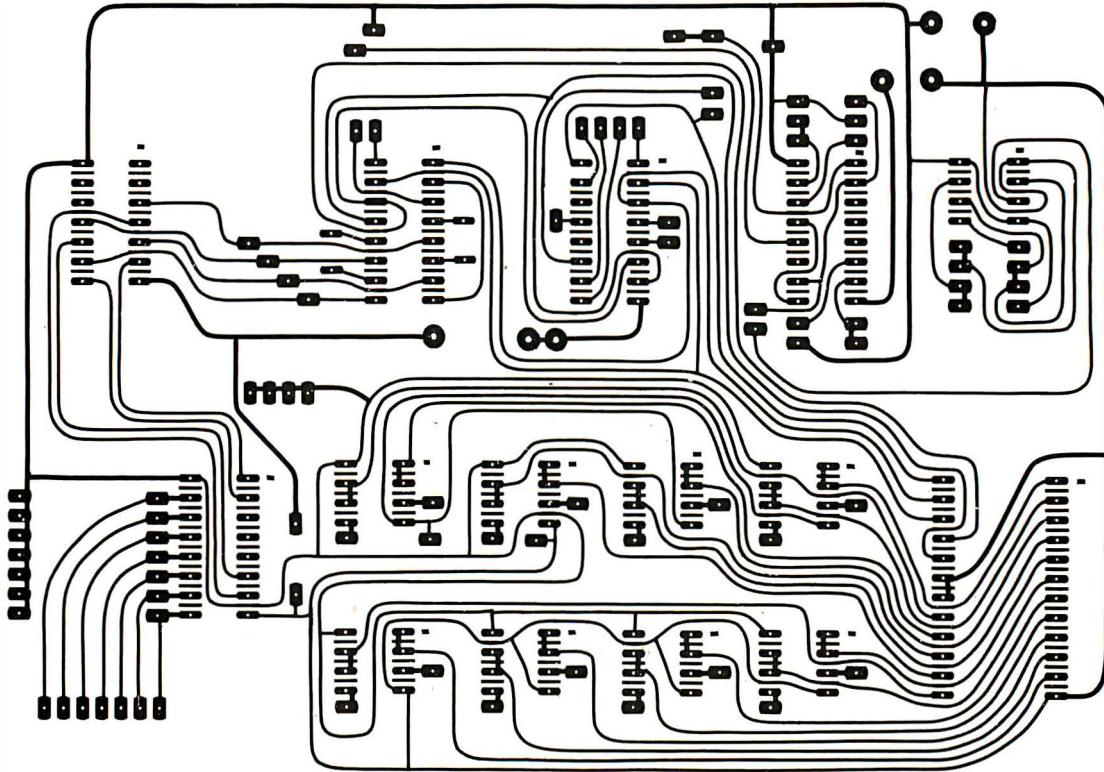

digit address input lines are connected to IC3 inputs A, B, C and D. To program the display, set the desired BCD value at the BCD inputs, select the desired digit with address lines A0 to A3, and bring the clock input to the low state for a minimum of 200 ns. The first digit is selected by setting a binary 0 at the address input; digit number 4 is selected by setting a binary 3 at the address input, etc.

Any 7 segment common cathode LED may be used with this display. MAN 4 or DL 704 LEDs work well, wired up using the display card of figure 5. The use of the peripheral interface gates means that a single 5 volt power supply will be adequate without any extra LED driver circuitry. The entire display (either one) will draw 300 to 400 mA.

The 8 digit multiplexed display may

Figure 5a: Printed circuit pattern (foil side) of an 8 digit 7 segment LED assembly used with the display circuits.

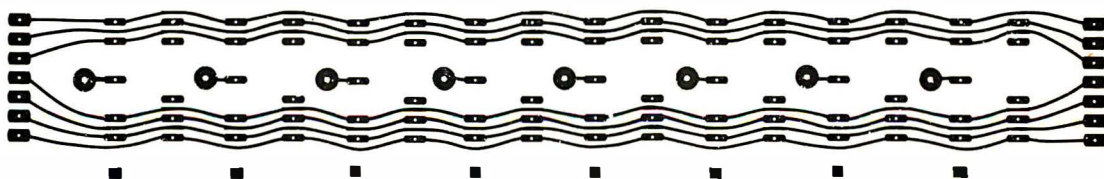

PRIME RADIX

ANNOUNCES
THE

64K™

WE DO IT WITH MIRRORS!

(and some very sophisticated state-of-the-art memory design)

You've probably imagined that someday you'd like to own a computer system with a full complement of memory:

65,536 BYTES

Your dream can be a reality with the Prime Radix Corporation's 64K™ memory system at a very cost-effective price. And because it is a standalone memory system, you've got the advantage of greater flexibility not ordinarily available from add-in memory. Some of the features are:

- The 64K™ is fully buffered, presenting one TTL load to the memory bus.
- The 64K™ is digital group bus and ALTAIR™ bus compatible. **When ordering, you must specify the bus architecture.** A plugcard and cable will be furnished for the particular bus architecture you specify.
- The minimum complement of memory is 40K BYTES, with starting address locations at 0K, 8K, 16K, or 24K.

- The 64K™ comes assembled and tested with its own power supply, attractively housed in an aluminum cabinet, ready to plug into your system.
- Pseudo-static operation: on board refresh clock-generator provides processor independent refresh with no wait states. The 300NS worst case access time enhances high speed operation.
- Power/fail detection circuitry and battery backup will provide non-volatile memory (batteries are optional at extra cost).

LIST PRICE IS AS FOLLOWS:

40K	48K	56K	64K
\$1490.00	\$1580.00	\$1670.00	\$1750.00

We are offering a special introductory ten percent discount off list price on all orders received on or before February 28, 1977. Delivery will be made in the same sequence as orders are received. Please allow 3 to 6 weeks for delivery. Mastercharge and BankAmericard are accepted.

PRIME RADIX • P O Box 11245 • Denver Colorado 80211 • (303) 433-5630 or 573-5942

PRIME RADIX COMPUTER SYNTHESIS

DIGITAL GROUP BUS

ALTAIR™ BUS

64K @ \$1750.00

56K @ \$1670.00

48K @ \$1580.00

40K @ \$1490.00

Check or M.O. enclosed

Charge BAC

Charge MC

(Please No C.O.D.'s or P.O.'s)

Make checks or money orders payable to:

PRIME RADIX, INC.
P.O. Box 11245
Denver, Colorado 80211
(303) 433-5630 or 573-5942

Print Name

Address

City State Zip

Credit Card Number

4 Numbers Above Name (MC) Good Thru

Signature

Figure 4b: Printed circuit component side map of the 16 digit display. See figure 2 for identification of components. Jumper wires are shown as dotted lines in the overlay.

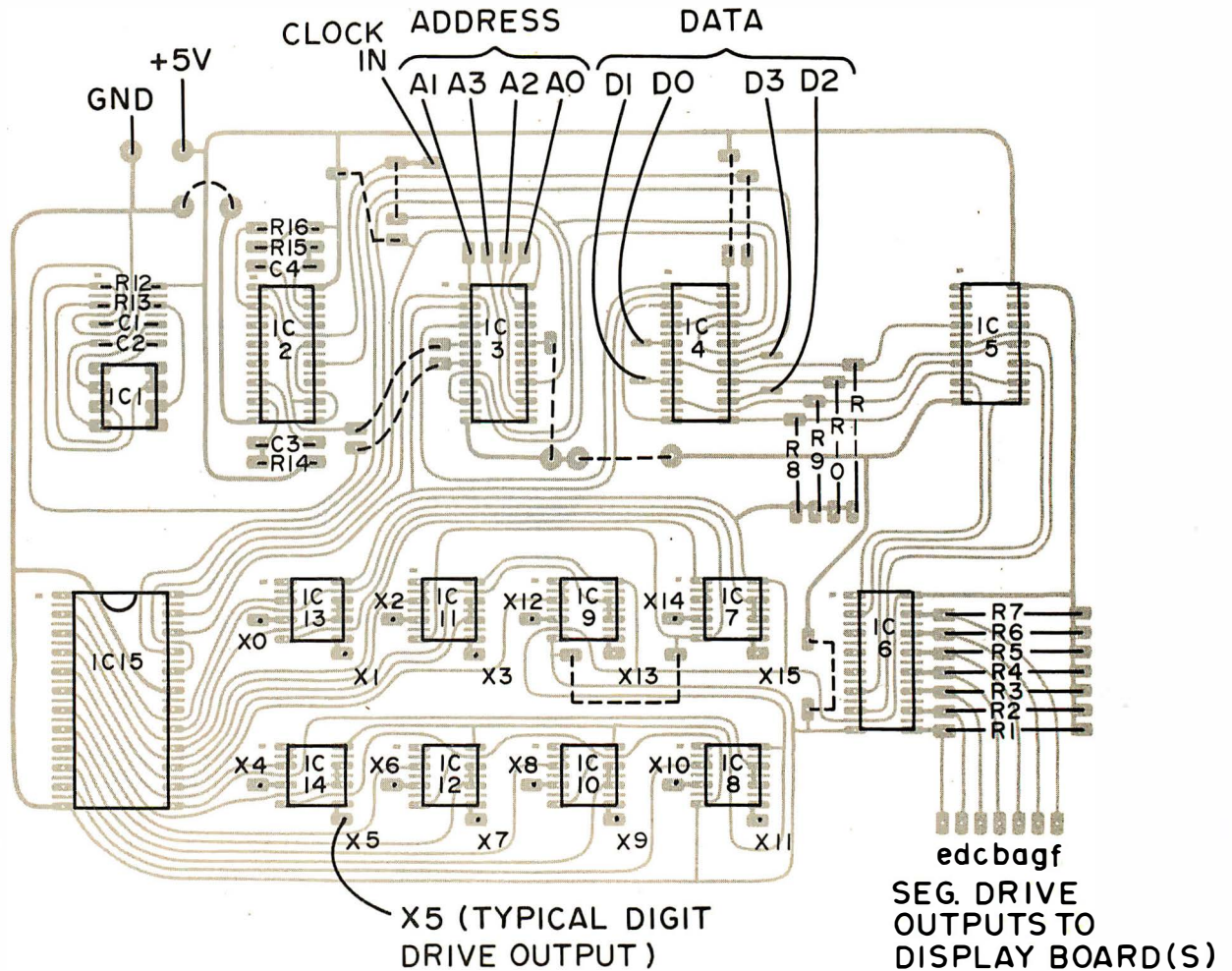

easily be used to replace the binary lights on a computer as an octal display. This display board is also a handy readout for any number of homebrewed instruments.

The programmable display may be used as a computer output. Connect the address and data inputs of the board to the 8 bits of

an output port. Connect the clock pulse input to the computer's output strobe line. Remember to program the computer to include the correct digit address in each data output. For use with hexadecimal data, use a substitute for the 7448 which decodes hexadecimal 7 segment patterns. ■

Figure 5b: Printed circuit component side map of the display matrix. The LED parts are MAN 4 or DL704 seven segment displays or their equivalents.

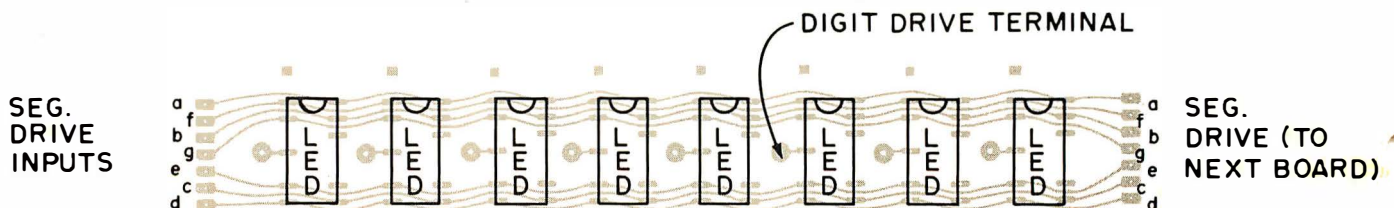

recommend that a short program be written to cycle the cassette output between a one and zero every few seconds. Connect a frequency counter to the output and readjust the mark and space pots to the correct specifications. I also noticed that variations in power supply voltages from one time to the next can adversely shift this frequency. Having an adequate well designed power supply will limit variabilities even as more memory is added. My 10 K system draws approximately 4.4 A at 5 V and with 18 K on it; it now takes 5.7 A.

The last comment is no Digital Group problem, but rather mine. I assembled the 10 K memory board as instructed, plugged it into the system and ran the DGS memory test program for a couple of hours. It all checked out fine, but when I tried to read any program which occupied 10 K of memory (2 K worked fine) it bombed out. Since the memory test program said the memory was fine, I was led to suspect the 10 K BASIC tape. I shipped that tape off to a friend to try it on his DG system and contacted the Digital Group software people for a new tape. Within five days I had both a new tape from DG and confirmation from my friend that I had a problem because the tape was OK. But the memory test said the memory was OK! Well, don't believe it! In the process of removing and checking each 2102 on my 8008 system I found an IC with a pin bent under it. Straightening this pin and reinserting the 2102 was all that was needed, and the Tiny BASIC read and executed perfectly. Be careful of memory test programs.

In conclusion, my experiences with the Digital Group 8080A System have been gratifying. My system worked with no major problems, and any intelligent user either constructing the computer in whole or part should expect the same. The fact that I now have an operational microcomputer has caused a slight problem, though. I never get to use it! I seem to continually have people from my office over in the evenings programming one thing or another. In fact, I had to add another 8 K this week to allow more Tiny BASIC programming space for one guy who is writing a statistical program which he hopes will help him win at jai-alai. I suggest that if you get one of these small computers, just walk around with a pleasant pregnant smile, but for heaven's sake don't tell anyone that it really works! ■

[Watch for Steve's humorous account of jai-alai in April's BYTE.]

\$795



ECONOMY TERMINALS ANNOUNCES:

AN INTRODUCTORY OFFER ON THE ET1 CRT TERMINAL

- 24 x 80 display of the 64 uppercase ASCII characters
- 12" Industrial 15 Mhz monitor with anti-glare screen and filter
- 90-day warranty (parts and labor, F.O.B. factory)
- 96-hour elevated-temperature operating test on each ET1 before shipping
- RS-232 and 20 ma interface
- LF, CR, BS, Local, Rubout, Break, Home Clear, Tab*, Remote Cursor Placement*, and Scroll* functions with special function keys
- Sixteen switchable baud rates to 19,200
- Odd, even and mark parity with one or two stop bits
- Micro-Processor Based, with 63-key keyboard

*These functions vary with model selected.

PLEASE CALL OR WRITE FOR MORE INFORMATION.
THIS OFFER EXPIRES 30 APRIL, 1977.

**ECONOMY
TERMINALS**

Box 12261
Minneapolis, Minn. 55412
(612) 522-1076

MORE POWER TO YOUR ALTAIR*

**12 AMPS @ 8v. (nominal)
2 AMPS @ ± 16v.**

At any line voltage from:

90 to 140 volts.

Installs easily **inside** any Altair* 8800 or 8800a.

Over voltage and over current protected.

Conservatively designed and specified.



only \$90.00

postpaid in the U.S.A.
California residents add
\$5.40 sales tax.



PARASITIC ENGINEERING

PO BOX 6314

ALBANY CA 94706

*Altair is a trademark of MITS Inc.

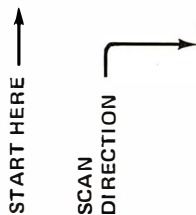

PAPERBYTES™

Test

As noted in last month's BYTE, page 121, we had intended to have an extended text included in the magazine for February. The text got delayed, due to a combination of human, weather and Murphy's Law Factors. This month, it arrives at the printing presses for publication.

This text is an extended set of ASCII encoded English language words. The bit level format is format 3 (compressed ratio recording) as described in previous articles on the subject in BYTE November 1976, page 10, and BYTE December 1976, page 12. In this format, the width of the bars and spaces are encoded as follows: space = 1 unit width; zero bit = 1 unit width bar; one bit = 2 unit width bar. The frame format begins with an ASCII SYN (10010110) character extended to 8 bits with a high order 1 bit. The frame continues with 8 bits of check sum, 8 bits of line identification, and 8 bits of byte count. The byte count sets the number of data bytes which follow the header.

Add Some Zest by Making a Contest

Rather than just print another test, we decided to make this text sufficiently complex to warrant making a small contest out of it. Within the frame format we have encoded the plain text of ASCII upper and lower case characters (plus line control) defining Walter Banks' parody of a famous poem dealing with mythical critters and strife and conquests. Lewis Carroll purists will object to the arbitrary and incomprehensible semantic transformations made on the arbitrary and incomprehensible semantics of the original, but the necessities of making a contest required uniqueness: This version has never been published before and it is completely different at the detail level. All contests have ground rules, and here are the ones which apply to the first (and probably only) PAPERBYTES Contest:

- Entries must be received in our office by March 31 1977. They should be addressed:

BYTE magazine
Attention: PAPERBYTES Contest
70 Main St
Peterborough NH 03458

ACT-I

MICRO-TERM INC.



\$525 complete with high resolution 9" monitor • \$400 without monitor INCLUDED FEATURES:

- Underline Cursor
- RS232C or Current Loop
- All oscillators (horiz., vert., baud rate, and dot size) are crystal controlled
- 64 characters by 16 lines
- Auto Scrolling
- Data Rates of 110, 300, 600, 1200, 2400, 4800, and 9600 baud are jumper selectable

The ACT-I is a complete teletype replacement compatible with any processor which supports a serial I/O port. Completely assembled and dynamically tested.

Prices FOB St. Louis Mastercharge and BankAmericard

THE AFFORDABLE CRT TERMINAL

MICRO-TERM INC. P.O. BOX 9387 ST. LOUIS, MO. 63117
(314) 645-3656

MULLEN COMPUTER BOARDS

BOX 6214 • HAYWARD, CA. 94545

EXTENDER BOARD

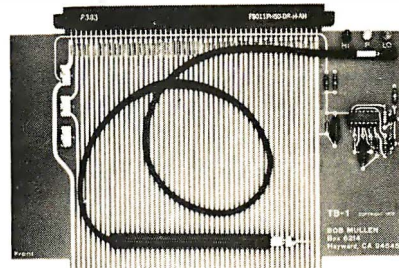

ALTAIR/IMSAI COMPATIBLE

NEW FOR TROUBLESHOOTING AND DEVELOPMENT: A SUPER EXTENDER BOARD FOR THE S-100 BUSS.

- Built in, 3 LED TTL logic probe
- Jumper links in power lines for easy current measurement and fusing
- Edge connector label identifies all pins
- Outstanding instructions
- Full width card; gold connector teeth

• AT YOUR LOCAL COMPUTER STORES, OR ORDER BY MAIL.



RD KIT: \$35

Personal Computing Goes National

**It's happening at the Dallas Convention Center
during the 1977 NCC, June 13-16**

The 1977 National Computer Conference will be the year's largest gathering of data processing users, computer professionals and computer hobbyists. More than 25,000 people are expected to gather in Dallas for a conference program of more than 100 sessions and the year's largest display of computer hardware, software, systems and services – plus the first annual National Programming Contest and a series of outstanding Professional Seminars.

Specially featured will be the first NCC Personal Computing Fair & Exposition, comprising a Personal Computing Fair, papers and panels, club congress, headquarters hotel and product exhibits by leading manufacturers.

Entry Deadline Coming Fast

Personal Computing Fair entries must be non-commercial personal or group-owned small computing systems. They may feature hardware and/or software implementations, games, recreation, music, art, amateur radio, scientific, miscellaneous and general applications. Prizes and awards will be given in all categories.

Working systems are desired, although projects that might not lend themselves to display at the fair might be illustrated audio/visually if the judges believe the project is acceptable otherwise. NCC will provide at no charge the booth space, a sign, coordinated furnishings, power and lighting. Accepted entrants will earn free full conference registration (except for the Proceedings).

For information, write or call Ric Martin, Personal Computing Fair chairman, c/o The Micro Store, 634 S. Central Xwy., Richardson, Tx. 75080, 214/231-1096. To enter, send him a concise, one-page, double-spaced description of your system, with your name and home and business addresses and telephone numbers.

**Entry Deadline Is March 15
Acceptance Announced By April 15**



1977 NATIONAL COMPUTER CONFERENCE

Dallas Convention Center • June 13-16

LET YOUR COMPUTER XPRES ITSELF!

Your computer can control lights, burglar alarms, Hi-Fi's, PHASORS; practically anything if properly interfaced.

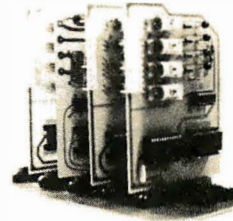

XPRES is a complete interface system. ONE EIGHT BIT PORT CONTROLS 128 SEPARATE DEVICES. Connect to Imsai, Altair, or SWTPC; any processor with an eight bit port.

IMB-01 system mother board, holds five interface boards, complete with connectors.
KIT \$28.00

IFB-01 interface board, controls two 115 VAC 300 watt circuits. Optically isolated.
KIT \$38.00

IFB-04 interface board, controls 4 small signal AC/DC circuits with reed relays.
KIT \$36.00

CRC Engineering

P.O. Box 6263
Bellevue, Wa. 98007
(206) 885-7038

- Each entry should contain a stamped self addressed envelope (as well as redundant identification of the contestant) in the event materials are not used by our office in the publication.
- Each entry must contain the completely decoded text, either as a printed text listing (upper and lower case) or as a hexadecimal absolute data listing with one line per line of bars. Handtyped listings are fine, if you don't have a hard copy device.
- Each entry must be accompanied by a complete and detailed technical description of the system used to decode the text. Hand decoding is not an acceptable method. Brownie points in the judgment of entries will go to the least expensive systems (other things being equal).

While it is not necessary to treat entries as a formal technical article submission, winners and runnersup in the competition may be published with payment at our current rate for highly desired technical materials.

The Prize?

A check for \$100 will be the bonus for the winning entry in this contest, as judged by BYTE's editor Carl Helmers based upon materials submitted.

A Note About Formats,
Coming PAPERBYTES Items, etc.

In this sample text, we do not provide the equivalent human readable form of materials. This is due to the nature of this month's test which is being treated as a contest. The arrow identifies the beginning of the text.

Normal practice when publishing programs in BYTE is expected to include printing of a complete hexadecimal object text for programs as a confirmation of the bar coded machine readable texts. Production problems notwithstanding, the first program we expect to print in this form will appear as bar codes in the May 1977 BYTE in the second part of Jack Emmerichs' article on his "Tiny Assembler" for the Motorola 6800. We've been using Jack's assembler (we = Walter Banks at the University of Waterloo, Carl Helmers at BYTE, Chuck Adams at Texas A&M University) since late in 1976. Also planned for future release in this form are additional

INTEL
The way ~~8080~~
meant it to be...

Intel specification	Parasitic Engineering Clock Fix Kit
60 nsec minimum	$\phi 1$ 80 nsec.
220 " "	$\phi 2$ 265 " "
0 " "	D1 35 " "
70 " "	D2 85 " "

Note: These are the actual clock waveforms at the 8080, as produced by a Parasitic Engineering Clock Fix Kit.

YOUR ALTAIR* 8800
can't run well without
a correct, reliable
C.P.U. clock.

A PARASITIC ENGINEERING
clock fix kit is
guaranteed to
produce $\phi 1$ and $\phi 2$
clock pulses, that
meet Intel's
specifications for the
8080. Installs easily on
your Altair* 8800 or
8800a C.P.U. board.

only \$15
postpaid in the U.S.A.

PARASITIC ENGINEERING
PO BOX 6314 ALBANY CA 94706

*Altair is a trademark of MITS Inc.

Here are 10 reasons why you should subscribe to *CREATIVE COMPUTING* today.

1.

Creative Computing will help you decide which computer is best for you.

Creative's no-nonsense equipment profiles arm you with the facts before you talk to the vendor or dealer. Whether you're interested in a microcomputer kit, a mini, terminal, or programmable calculator, you'll find the evaluative information you need in *Creative*. Indeed, one wise hardware decision could save you the cost of a lifetime subscription!

2.

Creative Computing discusses computer applications in non-technical, understandable language.

Business people who want to know what's going on in the EDP department, students who want to learn about microprocessors, hobbyists looking to make good use of home computers, or anyone concerned about the effect of the computer on society will find these and many, many more mind-expanding topics covered on the pages of *Creative*.

3.

Creative Computing covers computer education in depth.

After all, that's where we got our start and so we continue to present four or five major learning activities every issue. If you're a teacher, *Creative* will save you hours of preparation time. If you're a student, you'll be way ahead of your class with *Creative*. And if you've already graduated, you can bone up on what you missed.

4.

Creative Computing carries outstanding fiction every issue.

One of the best ways of exploring future scenarios of computer usage is through fiction, so *Creative* seeks out material from the best authors — Isaac Asimov, Frederik Pohl, Arthur C. Clarke to name just a few, as well as many others who are destined to be the best of the next generation.

5.

Creative Computing's book reviews are honest and timely.

We're not owned by a big book publisher to whom we owe loyalty, nor do we depend upon advertising for our revenue. Hence, not only do our reviews pull no punches, but we also rank order similar books (like all 34 books on the BASIC language which we reviewed last year). *Creative* reviews virtually every computer book of interest to educators, hobbyists, and general laypeople, even including vendor manuals and government pamphlets.

6.

An extensive resource section will save you time and money.

Every issue of *Creative* carries 40 or more short resource reviews evaluating periodicals, booklets, hardware, terminals, couplers, peripherals, software packages, organizations, dealers, and much more. Every entry has a brief description, evaluation, and the name, address, and phone number of the vendor. You'll save valuable time seeking out this information, much of which you'd possibly never come across.

7.

Creative Computing will provide hours of mind-expanding entertainment, even if you don't have a computer.

Creative Computing carries 10 or 12 pages of games and puzzles every issue. Most of the puzzles don't need a computer or calculator to solve, some do. Naturally, the 4 or 5 new computer games (in Basic, Fortran, and APL) in every issue require access to a computer.

8.

Creative Computing gives you things to actually do with a computer.

Home computer kit, mini, timesharing terminal — whatever your access to computer power, *Creative* provides thoroughly documented programs with complete listings and sample runs that you can use with minimum effort. Games, simulations, CAI, computer art — whether education or recreation is your bag, you'll find programs which you can use in *Creative*.

9.

A no-compromise policy of editorial excellence means every issue is of value to you.

We firmly intend to be around a long time and we believe the way to do that is to publish only material of the very highest quality. We believe our readers are among the most astute, intelligent, and active people in the world. You can't afford to waste time reading imprecise, opinionated, or wordy articles and you won't find any in *Creative*.

10.

The price is right — only \$21 for 3 years.

That same \$21 will buy you a pair of Star Trek walkie talkies, six direct dialed 10 minute calls between New York and Boston, 3 tankfuls of gas, or 10 cocktails at a Hilton hotel. Wouldn't you rather have 18 issues of *Creative Computing* each containing over 85 pages of solid editorial material (including advertising, over 100 pages per issue)? Count the editorial pages in *any other* hobbyist or special interest magazine and compare it to *Creative*. *Any other*, 1 year subscription \$8. Lifetime \$300.

NO RISK GUARANTEE

You may cancel your subscription at any time for any reason and we will refund the balance without question.

David H. Ahl, Publisher

FOR FASTER RESPONSE

You can phone your subscription orders to us at (201) 366-5617. Our lines are open from 9 am to 4:30 pm EST.

SUBSCRIPTION ORDER FORM

Type	Term	USA	Foreign
Individual	1-Year	<input type="checkbox"/> \$ 8	<input type="checkbox"/> \$ 10
	3-Year	<input type="checkbox"/> 21	<input type="checkbox"/> 27
	Lifetime	<input type="checkbox"/> 300	<input type="checkbox"/> 400
Institutional	1-Year	<input type="checkbox"/> 15	<input type="checkbox"/> 15
	3-Year	<input type="checkbox"/> 40	<input type="checkbox"/> 40

New Renewal

Cash, check, or M.O. enclosed

BankAmericard Card No. _____

Master Charge Expiration date _____

Please bill me (\$1.00 billing fee will be added)

Name _____

Address _____

City _____ State _____ Zip _____

Send to: Creative Computing, Department B
P.O. Box 789-M, Morristown, NJ 07960

systems software programs for the popular processors.

What About Source Code?

When publishing object code for extended programs, such as Jack's assembler, or a BASIC interpreter or other software, the length of the source listings preclude reproduction in the magazine. The source code of the Tiny Assembler runs 40 pages for example. To provide the source code for those individuals seriously interested in modification and extension of programs of this form, PAPERBYTES will be making available extended documentation for programs including users manual information, source listings, a reprint of any BYTE articles discussing the programs, and additional documentation depending upon the type of program being published. The PAPERBYTES release of Jack Emmerichs' assembler user's manual is in preparation coincident with preparation of his articles for publication. ■

Attention, Engineers of Bar Code Readers:

On page 320 of the November 20 1976 issue of *EDN* magazine, there is a short note sent in by Wesley Grenlund of Beloit Corporation, Rocton IL, concerning a signal processing circuit for scanners. The circuit combines a Texas Instruments TIL139 source-receiver assembly with the 75140 line receiver to make a TTL level input to the single bit port needed by bar code scanning software. The only additional part probably needed is some slit optics (.01 inch [.0254 cm] wide for our bars) to define a limited active area. The slit would be positioned in front of the intersection point of the source beam and the receiver viewing path, as suggested by Dave LeVine.

We received a similar hint to use the TIL139 in early October from Dave (who is chief engineer of Computer Link, Burlington MA). Dave says he has successfully used the TIL139 together with a single National Semiconductor 74C14 hex Schmitt Trigger integrated circuit as the sole input processing amplifier: This version uses one of the Schmitt triggers in the package as a capacitively coupled amplifier (open loop and saturating), with the remaining five triggers ganged in parallel to drive a TTL unit load from the output of the first trigger. This hint popped out of Dave in the context of the usual "micro session" (would be called "bull sessions" in any other field) which occurred at the October 1976 meeting of the New England Computer Society. ■

comptek Boards DO Something

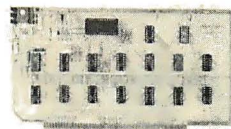

CL2400
Real Time Clock

\$98—Kit \$135—Assembled

If your system needs to know what time it is, our **CL2400** is the board for you. The present time in hours, minutes, and seconds is always available for input, and is continuously updated by the highly accurate 60 Hz power line frequency. Need periodic interrupts? The CL2400 can do that, too, at any of 6 rates. Reference manual with BASIC and assembly language software examples included.

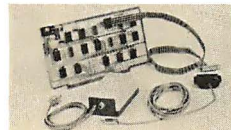

PC3200
Power Control System

PC3232 \$299—Kit \$360—Assm.
PC3216 \$189—Kit \$240—Assm.
PC3202 \$39.50—Kit \$52—Assm.

If your system needs on/off control of lights, motors, appliances, etc., our **PC3200 System** components are for you. Control boards allow one I/O port to control 32 (PC3232) or 16 (PC3216) external Power Control Units, such as the PC3202 which controls 120 VAC loads to 400 Watts. Optically isolated, low voltage, current-limited control lines are standard in this growing product line.

comptek
"Real World Electronics"

P.O. Box 516
La Canada, CA 91011
(213) 790-7957

CONGRATULATIONS

WE DID IT! THE 6800 IS COMPLETE

SWTPC 6800 PLUG COMPATIBLE PRODUCTS —
COMPLETELY ASSEMBLED

- M-16 A 16K single power supply STATIC RAM memory system. The M-16 is fully buffered and requires only half the power of a similar size system using low power 2102's. With the M-16, you can expand your system to 48K and still have room left over. Price \$595.
- P-38 An 8K EPROM board containing room for 8 2708's. Alternately, you may use it to hold up to 7 2708's plus your Motorola MIKBUG, MINIBUG II or MINIBUG III ROM. Using it in this mode at E000 through FFFF you have direct access to the restart and interrupt vectors which are then switch selectable between MIKBUG and your EPROM but still under MIKBUG control. The P-38 addressing is switch selectable to any 8K location. Together the P-38 and M-16 allow various combinations of RAM plus EPROM up to 56K. Price \$179.
- P-38I Contains all the features of the P-38 plus interface capability to the Oliver Paper Tape Reader and our EPROM programmer which will be announced shortly. Price \$229.
- P-38FF Contains all the features of the P-38I plus a plug-in interface to the ICOM Frugal Floppy. Includes one 2708 with the ICOM bootstrap software. Price \$299.
- PS-1 Power Supply Kit. Provides plus and minus 16 volts required for up to 5 P-38 series systems. May be wired to provide a one volt increase in the plus 8 volt supply. Recommended for any system where the 8 volt supply falls below 7.7 volts under normal load. Price \$24.95.
- BFD-68 Basic Floppy Disc System. Complete with controller, cabinet, power supply and one mini-floppy drive. Cabinet, power supply and controller will accommodate up to 3 drives. Includes our nifty Disc File Management software. Assembled and ready to plug into your SWTPC 6800. Price \$795. Additional drive and interface cabling \$429.

ALL OUR PRODUCTS EXCEPT THE PS-1 ARE COMPLETELY ASSEMBLED. AVAILABLE AT MOST SWTPC DEALERS OR FROM US BY MAIL. BANKAMERICARD AND MASTERCHARGE WELCOME.

SMOKE SIGNAL BROADCASTING

P.O. Box 2017, Hollywood, CA. 90028

BYTE BINDERS and FILES

Preserve those precious first 16 issues with either a handsome but rugged library file—or a binder—in flag blue Kivar library fabric stamped in gold leaf.



Files: Made to hold the first 16 issues of BYTE. Price per file \$4.95; three for \$14; six for \$24, postpaid.

Binders: Made to hold the first 16 issues of BYTE. Price per binder \$6.50; three for \$18.75; six for \$36, postpaid.

(Add \$1 each outside USA.)

Send to: **BYTE, POB 5120, Philadelphia PA 19141**

I enclose check or money order for \$ _____

Please send me _____ BYTE _____ Files _____ Binders

Name _____
(please print)

Address _____

City _____

State _____ Zip _____

Satisfaction guaranteed or money refunded. Allow at least four weeks for delivery.

BYTE's Bits

Guinness, Take Note:

The World's First Commercial Personal Computing System Product to Use 16 K Dynamic Programmable Memory Chips . . .

A recent phone call from Steve Jobs (who, with Steve Wozniac, is responsible for the Apple Computer Company) reported what is claimed to be the first shipment of a personal computer systems product built with the new 16 K dynamic memory chip products. The product which used these chips was an Apple I — an MOS Technology 6502 processor board with 32 K 8 bit bytes of memory (16 chips), read only memory systems software, and video interface. The board was delivered to one of the Byte Shops in the San Francisco Bay area on December 17 1976, for sale to a retail customer.

Larger and larger amounts of memory will be the trend in small computer systems for some time, due to the combined factors of its immense desirability as a programming resource and the dropping prices of the new LSI semiconductor technology. The use of the 16 K chips in Apple was made possible by the fact that the manufacturer of these memory parts chose to make the 16 K designs essentially pin compatible with their older 4 K designs by using a change in the logical interpretation of one of the lesser used pins of the package. This pin now serves as the seventh address bit in each of the two 7 bit address segments which form the 14 bit address needed for a 16 K bit array. The Apple product demonstrates the success of this idea since it will take any combination of 4 K and 16 K chips in byte wide groups. Watch very shortly for advertisements of the new Apple II computer, both as a finished product and as a board level computer which looks like it will be an excellent and innovative addition to the marketplace. ■

A HAM Swapfest

The 7th Annual North Florida Swapfest sponsored by the Playground Amateur Radio Club (PARC) will be held in Fort Walton Beach FL at the Okaloosa County Shrine Fairgrounds on Saturday, March 19 and Sunday, March 20 1977. The Swapfest will be a full weekend affair with the display area open from 8:00 AM to 4:00 PM each day. A dinner, featuring a prominent speaker, will be held at the Fort Walton Beach Holiday Inn Saturday evening. The North Florida Swapfest is an annual event, sanctioned by the American Radio Relay League (ARRL), and draws hundreds of Radio Amateurs and electronics experimenters primarily from Louisiana, Mississippi, Alabama, Georgia, and Florida, although

amateurs from many other states attend.

The North Florida Swapfest is a nonprofit function and proceeds are used to finance local Amateur Radio projects, the next year's Swapfest and the Playground Amateur Radio Club Scholarship Fund. Interested in information on booths or attendance? Contact Bill Callanan WB4FTA, Swapfest Chairman, Playground Amateur Radio Club, POB 433, Fort Walton Beach FL 32548. ■

A Mention

MICROCOMP is a new computer store, dealer of OSI products, located at 785 S Main St, Fond du Lac WI 54935. Phone (414) 922-2515, or write Nyles Priest of MICROCOMP. ■

BYTE's Bugs

Why the DACs "Don't Work"

Author Steve Ciarcia sent our way (via his friend Chris Morgan who stopped by one recent Saturday) the following correction to his article "Make Your Next Peripheral a Real Eye Opener" on page 78 of November 1976 BYTE. In the schematic of pages 84 and 85 (figure 2), we (Steve or CH at BYTE? Who knows?) omitted notation of the negative supply pin for the MC1408-L8 digital to analog converters, IC4 and IC5. Pin 3 of each 1408 should be wired to the -15 V supply. ■

Weathering the Storm

Author Mike Firth, whose article "Do It Yourself Weather Predictions" appeared on page 62 of December 1976 BYTE, sends in the following items:

In my article on the weather, a call from Tom Harper in Miami FL has put me on the track of two problems, which I describe below:

On page 66 (BYTE December 76), the simple formula for relative humidity ($H=100\% - T*5$) is said to be for centigrade temperatures, but in fact it is for Fahrenheit, an error caused by an error in my original source. To use the equation for centigrade temperatures, the 5 should be changed to an 8.

In using the more complex formula, three different values of E, the vapor pressure, must be used, but my article made it seem that only two were needed. Two are obtained from a table or by interpolation from the values given at the top of page 66. They are E_w , the vapor pressure of water at the wet bulb temperature, and E_d , the vapor pressure of water at the dry bulb temperature. The third value is E, the actual vapor pressure in the air from the formula. The proper formula for relative humidity is then:

$RH = E/E_d$ (not $RH = E/E_w$ as given in the article). ■

SOFTWARE

8080 PACKAGE

AS PROMISED TSC IS RELEASING THE 8080 ASSEMBLER LANGUAGE GAME PROGRAM PACKAGE. THIS IMPRESSIVE COLLECTION OF SOFTWARE INCLUDES THE POPULAR GAMES ACEY-DUCEY, HANGMAN, MASTERMIND SWITCH, HURKLE AND A TSC RANDOM NUMBER GENERATOR. THE PACKAGE CONTAINS WELL COMMENTED ASSEMBLED SOURCE LISTINGS, SORTED SYMBOL TABLE, HEX DUMP, INSTRUCTIONS AND SAMPLE OUTPUT, ALL IN AN ATTRACTIVE BINDER. NO TAPES AVAILABLE AT THIS TIME. ORDER PD80-1 \$19.95

6502 PACKAGE

A PACKAGE IDENTICAL TO THE ABOVE IS AVAILABLE FOR 6502 BASED SYSTEMS. THESE PROGRAMS ARE JUST WHAT YOU NEED. PD65-1 \$19.95

PROGRAM OF THE MONTH CLUB

PROGRAM OF THE MONTH CLUB IS A UNIQUE SERVICE AVAILABLE TO THE HOBBYIST. FOR \$2.00 YOU WILL RECEIVE A 1 YEAR MEMBERSHIP WHICH INCLUDES A MONTHLY NEWSLETTER DESCRIBING THE NEWEST 6800 6502, AND 8080 SOFTWARE RELEASES FROM TSC. UP TO A 15% DISCOUNT IS OFFERED TO MEMBERS ON FEATURED SELECTIONS. POM \$2.00

ORDERING INFORMATION

PLEASE INCLUDE 3% POSTAGE. INDIANA RESIDENTS ADD 4% TAX (US FUNDS ONLY). CHECK YOUR LOCAL DEALER FOR OUR PRODUCTS. (DEALER INQUIRIES WELCOMED). SEND \$.25 FOR A COMPLETE CATALOG.

TSC

TECHNICAL SYSTEMS CONSULTANTS
BOX 2574 W. LAFFAYETTE INDIANA 47906

TSC

Computer System Engineers

Computer Transceiver Systems, Inc., manufacturer of portable computer terminals, is expanding its R&D facilities. New developmental programs getting under way are specifically directed towards state-of-the-art applications of microprocessors and allied LSI components into the CTSI product line. Positions are open in several areas for knowledgeable, enthusiastic individuals who would like to join a small dynamic company and tackle challenging and rewarding projects.

MICROPROCESSOR SYSTEM ENGINEER

Qualified individual shall have a minimum of 10 years of design experience including 1-2 years of system design and implementation using microprocessors. Knowledge of TTL, MSI, and LSI essential. Ability to develop electro-mechanical interfaces desirable.

Designer shall also be capable of developing test equipment for use by manufacturing and field service.

SENIOR ELECTRONIC ENGINEER

Innovative engineer with a minimum of 5 years of experience with high-speed logic systems, and with hands-on experience with microprocessors. Must be familiar with TTL, MSI, and LSI components. Experience with power supply and analog circuit design desirable but not essential.

SENIOR LAB TECHNICIAN

Qualified applicant shall have a minimum of 5 years of experience assembling and testing prototype electronic systems. Must be familiar with the use of laboratory test equipment and must be capable of layout and breadboard assembly from schematics. Should be familiar with digital logic.



Send resumes to the attention of Mrs. Diane Palmer, Computer Transceiver Systems, Inc., P.O. Box 15, Paramus, N.J. 07652.

How To Make Your Computer Even More Boring...

interface it with a Midwest Scientific Instruments FD-8 Floppy Disk Memory System...with all your disk software on our PROM/RAM Board.

With our FD-8 system and FDOS firmware, your computer is always ready to go. With the disk operating routines on PROMS, all you have to do is load your desired program from disk and start running. Of course you may have to wait 5 or 10 seconds for your program to load if you have lots of memory.

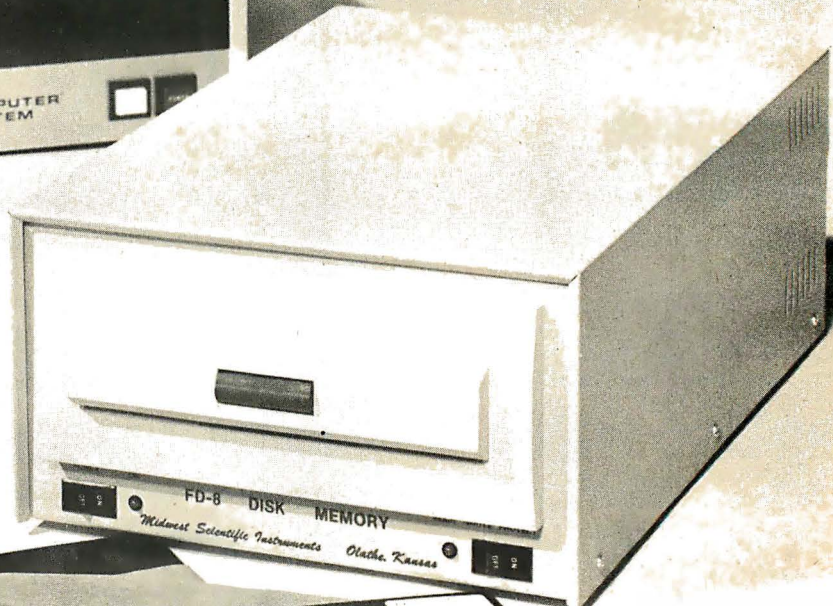

The FD-8 interfaces to any micro-computer system via a single PIA chip... and all of our available software is included at no additional charge.

- MSI FDOS operating system software has many outstanding features...
- Automatic program loading and linkage
 - Auto error recovery
 - Dynamic space allocation and file extension
 - Utilities for file listing, copying, deleting, or renaming

The FD-8 is complete, including cabinet, all power supplies, and cables.

- Prices:
- FD-8 Floppy Disk System Kit \$1,150.00
 - FD-8 System Wired and Tested \$1,395.00
 - PROM/RAM Kit (SwTPC 6800 or 8080)..... \$95.00
 - PROM/RAM Wired & Tested, with FDOS Firmware (specify 6800 or 8800 System)..... \$345.00

PR-1 Programmer & Verification Module

Designed to program 1702A PROMS, the MSI PR-1 interfaces with any microcomputer system via a single PIA chip.

A complete software package is furnished with the system at no additional charge. This gives you the ability to transfer any area of memory to a PROM chip...read the contents of a PROM into memory...calculate checksums for ROMS...and duplicate ROMS. Following PROM programming, the software reads the PROM back into memory and compares each step with the memory content from which it was programmed for verification.

The PR-1 is complete, including cabinet and power supplies.
PR-1 \$325.00

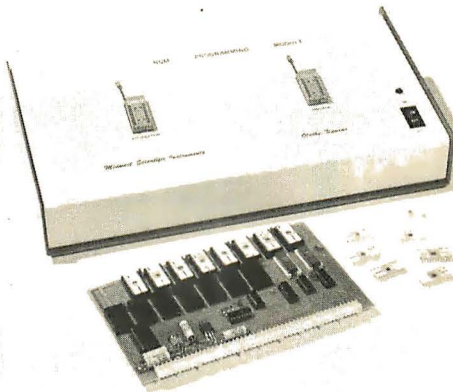
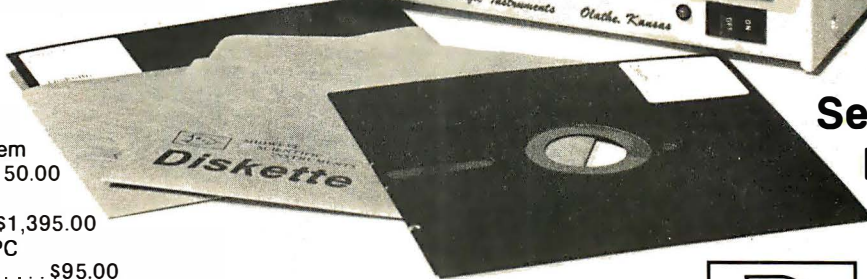

Here are two MSI Dealers who can show you our products in action

Microcomputer Systems, Inc., 144 S. Dale Mabry Ave., Tampa, Florida 33609
813/879-4301

American Microprocessors, Equipment & Supply Corp., Chicagoland Airport, P.O. Box 515, Prairie View, Illinois 60069
312/634-0076

Send for New Free Catalog



Midwest Scientific Instruments

220 West Cedar
Olathe, Kansas 66061
913/764-3273
TWX 910 749 6403 (MSI OLAT)

- Before I forget...send me information
- about the FD-8 Memory System...and
- your new catalog.

Name _____

Address _____

City _____

State _____ Zip _____

BY177

HOUSTON now has a full service outlet for microcomputers and accessories. Microtex, Inc., located in the Southwest section of Houston, Texas carries product lines from the following manufacturers.

- IMSAI • LEAR SIEGLER
- SWTPCO • NATIONAL MULTIPLEX
- TDL • ICOM

For your professional application or your own personal system, we can help furnish all your computer needs.

Microtex, Inc.
9305 - D Harwin Dr.
Houston, Texas 77036
713 - 780 - 7477

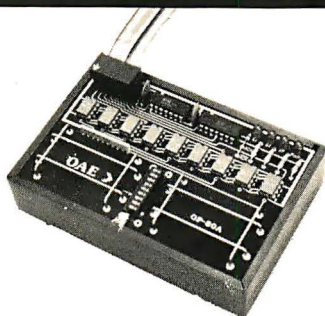

Pictured above is the new OP-80A High Speed Paper Tape Reader from OAE. This unit has no moving parts, will read punched tape as fast as you can pull it through (0-5,000 c.p.s.), and costs **only \$74.50 KIT, \$95.00 ASSEMBLED & TESTED.** It includes a precision optical sensor array, high speed data buffers, and all required handshake logic to interface with any uP parallel I/O port.

To order, send check or money order (include \$2.50 shipping/handling) to Oliver Audio Engineering, 7330 Laurel Canyon Blvd., No. Hollywood, CA 91605, or call our 24 hr. M/C-B/A order line: (213) 874-6463.

8,192 X 8 BIT STATIC MEMORY
EXCEPTIONALLY LOW POWER

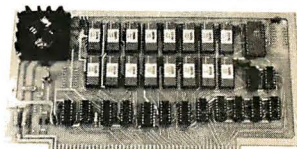

KIT \$295.00

PROTOTYPING BOARD

Z-80 - CPU

16K RAM

EXTENDER CARD

2K RAM / 2K ROM

CARD RACK AND POWER SUPPLY

LOW PROFILE IC SOCKETS

EDGE CONNECTORS

DB25 CONNECTORS

SHIPPING EXTRA, ADD \$2.00

NJ RES. ADD 5% SALES TAX

ELECTRONIC CONTROL TECHNOLOGY
P.O. Box 6, Union, New Jersey 07083

Microcomputer Equipment Survey

Can Help You Find
The Best Equipment
And Save Money

Prices and full specifications for more than 100 products from 30 manufacturers. Describes Systems, CPUs, RAMs, PROMs, Tape and Floppy Disk Drives, Keyboards, Video Displays, D/As, A/Ds and more.

Volume 1 \$5.00 postpaid



Computer Systems Design
1611 E. Central
Wichita, Ks. 67214

JGM DEVELOPMENT LABS

P. O. Box 2345
W. Lafayette, IN 47906
(317) 463-7167

1/4 watt carbon film resistors.....\$0.03
5 percent, 50 per value min.

1/2 watt carbon comp resistors...\$0.02
10 percent, 50 per value min.

No-Nik wire strippers.....\$16.00
10,12,14,16,18,21,23,25,28,31
34,37,44 or 54 thousandths
wire diameter

Carbide PC board drills
wire size: 55 - 65.....\$2.88
66 - 70.....\$2.97
71 - 75.....\$3.06
76 - 78.....\$3.60
79 - 80.....\$3.60

Spec sheets are available.

We would be pleased to send you a 'GOODIES' catalog listing all kinds of hard to find products including: Molex, Bishop Graphics, AMP, CDC manuals and forms, PC drills and mills, electronics tools, PC board manufacturing supplies, resistors, and semiconductors.

µCOMPUTER PROGRAMMING COURSE

Free description and outline of Modu-Learn™ Home Study Course in microcomputer programming. Hundreds of pages of text with examples, problems, and solutions. Prepared by professional design engineers using the best software design techniques from *structured programming* and *practical experience* with microcomputers. Presented in a modular sequence of 10 lessons oriented for the new programmer. Extensive reference material you will use long after you become an accomplished microcomputer software designer. Much of the information in the course has been available only through costly seminars. Now you can purchase this complete home study course for under \$50.00. Send for free descriptive brochure now.

LOGICAL
SERVICES INCORPORATED

711 Stierlin Rd, Mountain View,
CA 94043 (415) 965-8365

Classified Ads

FOR SALE: ASR-33 TTY with adjustment and parts manuals. Very good condition, \$700. With acoustic coupler, \$750. Donald Bailey, 19 Shaker Rd, Concord NH 03301, (603) 224-0486.

FOR SALE: Two MITS 88-MCD 4 K dynamic memory cards for Altair 8800, assembled, completely tested, meet specs for use with disk, \$200 each, including edge connector. Vintage BYTES, issues 1 through 4, \$5 each. David Richards, 6655 Hill St, El Cerrito CA 94530, (415) 529-0759, evenings.

FOR SALE: Attention computer hams: Morse to ASCII decoder. All controls accessible from front panel. Work with TVT 1 or TVT 2. I have helpful documentation on the decoder that I will pass along on request for \$1.50 to handle cost of photo copies and postage. Asking \$75 for the unit. Write Jack S Davis, POB 5, Endwell NY 13760, (607) 754-0309.

FOR SALE: E and L Instruments MMD-1 8080A based microcomputer complete with keyboard, 256 bytes RAM, 256 bytes of PROM programmed for keyboard entry and execution of programs, power supply, interfacing and breadboarding socket, case, and 40 pin edge connector for expansion. Includes modular, self-taught, micro-processor course. Assembled, tested, excellent condition, \$300. Richard Criscuolo, 303 Oak Av, Lindenhurst NY 11757, (516) 884-3882.

SWAP OR SELL: SWTP CT-1024 TVT 2 with serial IO, manual cursor, screen read, P/S. Two Altair 8080 CPU boards, Tarbell interface, HAL ST-6 Teletype converter with all options (can be used as a modem). All in like new condition and guaranteed perfect. Need hard copy printer or ??? Michael Shrayer, 930 S Bonnie Brae St, #331, Los Angeles CA 90006, (213) 380-6509

FOR SALE OR SWAP: Texas Instruments SR-52 card programmable calculator, complete with all standard accessories and manuals. It has a special programming manual with many programming tricks, procedures for accessing 60 data memories, and procedures for reading and writing data onto cards, \$200 or fair trade for S100 bus, Altair-IMSAl, compatible memory or IO. R W Toy, 155-A Duncan, San Francisco CA 94110, (415) 648-6105.

WANTED: November 1975 issue of BYTE. Will consider purchase or trade for this issue only, or possibly, for a set of issues. Chris Bauer, IEMS Dept, Florida Technological University, POB 25000, Orlando FL 32816, (305) 275-2236.

FOR SALE: Friden Flexowriter Baudot Teletype with five level paper tape punch/reader plus card reader. Can be converted to ASCII, \$95. Derek Hendry, 64 The Uplands, Berkeley CA 94705, (415) 654-5583.

Readers who have equipment, software or other items to buy, sell or swap should send in a clearly typed notice to that effect. To be considered for publication, an advertisement should be clearly noncommercial, typed double spaced on plain white paper, and include complete name and address information. These notices are free of charge and will be printed one time only on a space available basis. Insertions should be limited to 100 words or less. Notices can be accepted from individuals or bona fide computer users clubs only. We can engage in no correspondence on these and your confirmation of placement is appearance in an issue of BYTE.

Please note that it may take three or four months for an ad to appear in the magazine. ■

WANTED: Software and hardware schematics for music synthesizers (computer controlled or not). I am especially interested in automated music composition. Bill Struve, 505 Meade Cir, Memphis TN 38122.

WANTED: SCCS Interface issues December 75, February 76 and March 76. Please let me know if you have them for sale. Thomas R Bailey, 279 Gehring Rd, Tolland CT 06084, (203) 872-7084.

FOR SALE: Mostek F-8 evaluator kit fully assembled and working with literature. Two complete Viatron 2100 systems working with the complete literature pack. The first check (certified) or M/O for \$900 takes all. Donald E Scherck, Rt One, Collbran CO 81624.

SITUATION WANTED: Research physicist, with several years practical digital design experience, breadboarding, prototyping, etc; thorough reading knowledge of microprocessors and software. Looking for position with computer store, computer consultants or similar, in which my abilities can be traded for salary and chance to learn micros. Jay Kirschenbaum, 350 E 30th St, Apt 4L, New York NY 10016, (212) 684-5525.

NEED: BYTE issues 1, 2, 3, 8, 9 and 10. Willing to swap money for them, but have surplus copies of other issues of BYTE as well as assorted test equipment and digital hardware and components. How about a handful of 2102s? Hank Irvin, Dept of Physics, Tulane University, New Orleans LA 70118.

WANTED: I will buy your new, used, or dead Altair 8800, working or not, for cash. I am desperate for Altair. Help out a poor college kid. I will also trade for your machine. I have a scope and a Teletype. Call anytime. Jim Webb, POB 5224, Carson CA 90749, (213) 325-4684.

FOR SALE OR TRADE: PDP-8 mini-computer (straight-8), mounted in attractive walnut cabinet (spouse-approved for den). Complete with maintenance manual, drawings, 4 K BASIC, 4 K FOCAL, editor, PAL III assembler, disassembler, TTY interface, games, etc. Perfect condition. Free DECUS membership available for additional software. Presently in use with ASR model 33 Teletype. Can be sold with or without model 33. Sale price W/O Teletype \$800. Rex Engle or Jim Speidel, POB 10498, Charlotte NC 28288, (704) 374-6409.

TERMINALS: BURROUGHS 9350-2, ASCII, 15 cps upper and lower case, \$200. Friden Flexowriter, model SPS with paper tape reader and punch, \$200. Univac DCT500, 30 cps printer, no power supply or interface, \$100. Phil Hughes, POB 2847, Olympia WA 98507.

FOR SALE: Altair 8800 system with 8 K RAM, 88-SIOA, 88-ACR, 8 K BASIC, assembled and running, \$1167. SWTP CT-1024 complete, unassembled, less monitor and case, \$275. Friden ASCII communications terminal from Herbach and Rademan with control unit, \$200. Chris Foreman, POB 127, Reseda CA 91335, (213) 342-8845.

WANTED: BYTE issues for October and November 1975; April, May and June 1976. Please notify the following indicating price desired: Technical Library, Bell Telephone Laboratories, Western Electric Co, 2525 Shadeland Av, Indianapolis, IN 46206.

FOR SALE: Cryptographic program that will baffle the codebreakers of the CIA. Encode and/or decode your private correspondence for maximum security. Documentation of cypher technique, program listing and punch paper tape in BASIC for only \$6. Jon Stedman, 1528 Summit Rd, Berkeley CA 94708.

FOR SALE: Pacer: a 16 bit micro with TTY interface, line assembler in ROM and complete documentation. Assembled and running in cabinet with 32 key control assembly. Call (213) 243-5179 or write POB 430, Glendale CA 91206.

WANTED: Back issues of BYTE. Desire 1 copy each of issues 1 through 14. Will pay \$3 for each complete issue in good condition. Call (313) 323-3574 or write R Parenteau, 11020 Burlington #409, Southgate MI 48195.

WANTED: Back issues of BYTE magazine: issues 2, 3, and 8. Please send price and condition information to Art Leyenberger, 142 Kenilworth Rd, Ridgewood NJ 07450.

WANTED: BYTE magazine issues 7, 8, 9 and 10 in good condition only. Frank E Marfai, 2839 Hermosa Av, La Crescenta CA 91214.

FOR SALE: Brand New ASR-33 Teletype with auto reader. I reconfigured in midstream and will sell this superb \$1,188 value for only \$950. Immediate delivery instead of usual 4 to 6 month wait. J Katz, 1921 Pelham Av, Los Angeles CA 90025, (213) 474-3347.

FOR SALE: Altair 8800 computer, well built and checked out, \$500. Two MITS 4 K RAM boards, \$150 each. One P Tech 4 K RAM board, kit untouched, \$120. One 4 K x 8 EPROM board with assembled monitor, \$150. One MITS RS/232 S10 board, \$100. SWTPC TVT 2 with 510 and PS and keyboard and monitor, \$300. SWTPC cassette interface well built unchecked, \$70. 32R0 TTY new, \$300. Best offer takes any or all. Louis Doctor, BARH D311, RPI, Troy NY 12181, (518) 270-7586.

CHANGING HOBBIES: Want to swap miscellaneous ham gear for computer and/or peripherals. Have Heath SB-303 with optional crystal filter and other items too varied to list. Also have near new Heath stereo mike mixer and miscellaneous test equipment, all in good condition. Also willing to swap professional (First Class Federal License) assembly service or technical assistance for devices. Call or write Mike Hales, Route 1, POB 30W, San Juan TX 78589, (512) 383-7233.

WANTED: Manual or schematics and timing information for IO circuits of IBM model 72 Selectric typewriter/terminal. C G Bothner, POB 153, Landing NJ 07850.

FOR SALE: Tektronix model 611 graphics storage display scope, \$450. Also have Tektronix model 581 oscilloscope with type 82 plug in and scope mobile, \$400. Will trade for Altair 8080. Don Heinlein, 1546 E 215th Pl, Carson CA 90745, (213) 830-4225.

FOR SALE: Altair 8800a, 16 slot memory board, fan; two 4 K dyn, two 4 K static, (16 K total memory); ACR IO; 3P+S IO; TVT II with 64 characters per line; SCM Teletypewriter; software. \$2150. Will separate. Evenings: (312) 328-5610.

FOR SALE: GE core memory 16 K by 40 bits, all power and interface circuitry and documentation - been used with an 8080 processor. Litron Industries drum memory with full read write electronics. Bryant MBM drum memory. By unit or best offer over \$250 for lot. C H Eby, 7101 Mammoth Av, Van Nuys CA 91405, (213) 988-1763.

FOR SALE: Microprocessor system by Control Logic. Contains three basic cards; central processing unit using an 8008 input output control providing clocking and processor control signals, and memory address storage which provides latching registers for memory and output data control and a 256 byte PROM. Also included: 1 K of 2102 RAM, card mounting hardware, and logic diagrams, \$100. K Talen, 10605 Double Spur Loop, Austin TX 78759, (512) 258-4282.

FOR SALE: PolyMorphic VTI 64 video module, 64 characters per line, keyboard input port, Greek control characters, \$200. Morrow's Godbout Cassette Interface (BYTE Standard) fully expanded, with 3 cassette channels, parallel and RS-232 TTY IO ports, and operating system in EROM, \$120. Both boards assembled and working with ICs in sockets, and postpaid in continental US. Shipped within 24 hours of receiving MO or certified check. Tom Burke, 150 Church St, Burlington VT 05401.

MICRODATA REALITY: Are there any other computer hobbyists using this system? If so, I'd like to say hello, swap notes and programs, etc. Would also like to know where to buy a 4 or 8 way video terminal interface card and other peripherals for Microdata Reality (Model 1600 processor). Jack Hardman, 140 Forest Av, Glen Ridge NJ 07028, (201) 429-8880.

ST. LOUIS

COMPUTER FANS
VISIT THE

COMPUTER
SYSTEMS
CENTER

13461 Olive Blvd.
Chesterfield MO 63017

SWTPC - IMSAI - Cromemco
Micro-Term - More to come

Books - IC's - Software
Hardware & Systems
Consultation

(314) 576-5020

Computer Mart New York

LONG ISLAND

Computer leasing available.

IMSAI, SWTPCo, Digital Group
Processor Tech, Apple, OSI
TDL-Z-80, Seals, Cromemco,
Veras, Tarbell, Oliver

Magazines, books, chips,
sockets, connectors, terminals.

IT'S ALL HERE WAITING FOR YOU
FRIENDLY ADVICE TOO

New York City

314 5th Ave.

(32nd St)

New York 10001

212-279-1048

Tues. - Sat.

9:30 - 6:00

Thurs. - 9:00

Long Island

2072 Front St

East Meadow NY

516-794-0510

COMPUTALKER

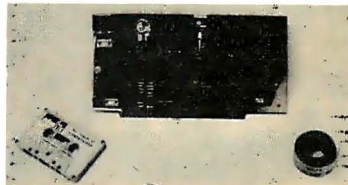

CT-1 SPEECH SYNTHESIZER

High Quality Voice Output
Altair/IMSAI/Polymorphic plug-in
Nine Acoustic Control Parameters
Includes 8080 Interface Software
\$395.00 plus shipping

Order a demonstration cassette
\$2.95 postage paid

Write for informative literature

Calif. residents add 6% sales tax

COMPUTALKER CONSULTANTS

P.O. Box 1951, Dept. B, Santa Monica, CA 90406
circle reader number 140

? CONFUSED ?

Save \$100 - 200
Up to 30% Discount

If you are like most people, you are being overwhelmed by the many computer kits, I/O Boards, peripherals, cables, interfaces, etc., that are flooding the market.

Who has the lowest price? Which is best? What works with what? How do you decipher the ads & specs., and what do you actually get? HELP!!!

We can take the hassle out of getting a system going. Let us know what you need & we will package a workable system for you - no loose ends - either kit or assembled for the lowest price around.

IMSAI, TDL, Processor Tech., Solid State Music, Oliver Audio Eng., Polymorphics, Lear Siegler, Cromemco, Used Equipment, TTY, etc.

With more than 10 years experience in the Mini-Maxi-Micro computer field, we know our way around!

BITS, BYTES & PIECES

6211 Quincewood Circle
Citrus Heights CA 95610
(916) 726-6469

THE BETTER BUG TRAP

The Better Bug Trap is an Altair/IMSAI plug-compatible board that extends system capabilities to facilitate software debugging and real-time processing. Capabilities include interval timer, real-time clock, watchdog timer, processor slowdown, and clock with variable rates. Four hardware breakpoint addresses allow you to stop processing or generate an interrupt at a breakpoint without modifying existing software. The board services its interrupt with a CALL instruction to ANY memory address you choose. All capabilities may be set by software or front panel. Write for free literature.

\$180 assembled, tested, complete documentation, software.

MICRONICS, INC.

PO Box 3514
Greenville, N.C. 27834

CHEAP, INC.

7338 Baltimore Ave., Suite 200
College Park, Maryland 20740

JOINT VENTURE

GROUP OEM BUYS

IMSAI made kits & assembled units 15% OFF LIST
TEC 9900-SS-UF, 16 bit 19900 microP, 32 bit 1/0, hardware mult & div. buffered bus, 20 ma or RS 232, 8 interrupts & sockets \$259.00
TEC 9900-32KB 32K bytes memory \$629.00
TEC 9900-PP power supply \$125.00
SPHERE kits & assembled units 10% OFF LIST
SWTPC kits & assembled units 10% OFF LIST
CROMEMCO kits & Z 1 10% OFF LIST
SANYO TV Monitors 10% OFF LIST
TDL ZPU & Z16K 10% OFF LIST
SEALS 8k bat. backup Mem 10% OFF LIST
PERSCI Dual floppy & intelligent controller #270 & 1070 \$1395.00
SHUGART MINI FLOPPY \$350.00

AMD FACTORY PRIME TESTED for MIL STD 883C
91L02 500ns \$1.90 9102 500 ns \$1.85
91L02 400ns \$1.99 9102 400ns \$1.95
Z-80 microP \$54.00 Z-80-PIO \$15.00
Z-80-CPC \$15.00 1702A EPROM \$8.00
8080A 2.5 MH \$17.00 8080A 3.0 MH \$20.00
8080 PPI \$10.00 8080SCI \$10.00
8212 I/O port \$2.50 8224 Clock Gen \$4.75
8228 Clock Driver \$5.50 8216/26 Driver \$2.50
9555 PPI \$9.50 9551 PCI \$9.50
2708 EProm \$65.00 2102 650 ns \$1.75

ADM-3K CRT & addressable cursor \$925.00 list \$825.00
AXIOM 80 col., 160 char/sec printer, parallel interface \$655.00 list, serial interface \$740.00 list 10% OFF LIST
Nat. Multiplex Digital Tape recorders & kits 10% OFF LIST
MSI floppys & kits 10% OFF LIST
Pennywhistle modem 5% OFF LIST
TI "silent 700" model 743, printer \$1395 list 5% OFF LIST
ASTRAL 2000 kits 10% OFF LIST

Send \$2.00 for newsletter & lists
other chips 2900 series, 4K mems etc.
16 pin socket & cap. for memory chip 25
full payment for discounts, add 4%, min 4.00
for shipping & handling, orders bulked for
lowest discount on OEM Group buys
prices subject to change without notice

Clubs and Newsletters

Conducted by
Peter Travisano

HP-65 Users Club

The HP-65 Users Club is by, of and for those people around the world who use and enjoy Hewlett-Packard calculators. Its newsletter *65 Notes* is a must for anyone stuck on these machines. Volume 3, Number 9, is a special games and programs issue. HP-25 Roulette is a mathematical duplicate of the Monte Carlo original, complete with broken bank. Depending on your imagination or your friends' bank accounts this program could conceivably save airfare to Las Vegas. Another program for your HP-25 is Battleship II, a game which starts with random shooting at your opponent's hidden fleet until a discernible pattern appears; after that, it's a race to sink the enemy's ships as quickly as possible. Number Guesser is a handy way to decide all kinds of distasteful things like whose car do we take or who pays for lunch: sort of an electronic short straw.

There are plenty of other games and ideas. So if you want to get the most out of your Hewlett-Packard calculator, be sure to send for more information from the HP-65 Users Club in care of Richard J Nelson, 2541 W Camden Pl, Santa Ana CA 92704.

Dayton Microcomputer Association Formed

Looks like Dayton OH hackers are off to a fine start with well over 100 hobbyists working together to form a new club.

Meetings take place on a regular basis, 7:30 PM on the last Tuesday of each month. For more information write Dayton Microcomputer Association, in care of Dayton Museum of Natural History, 2629 Ridge Av, Dayton OH 45414.

Montreal Micro 68 – Club des Mordus d'el Ordinateur – Computer Club

The world's first bilingual computer club has been organized in Montreal. Among other projects, Micro 68 plans to exchange computers, hardware applications and software with other clubs in the US. For more information, get in touch with John

Courtney, president, Montreal Micro 68 Computer Club, Case Postale al Succur Sale, Montreal CANADA H4Y 1A2.

Denver Amateur Computer Society – INTERRUPT

There are newsletters and there are newsletters, but DACS' fine publication, *INTERRUPT*, ranks with the superb handful that begin to invade the area of the print media set aside for magazines. There are plenty of interesting and competent features on micros.

Dealing with DACS is a good way to learn more about computers; they'll even help you get a club started in your area, which is probably the best way to share and spread knowledge.

Interested? Get in touch with the Denver Amateur Computer Society, POB 6338, Denver CO 80206.

Analytical Engine – Chesapeake Microcomputer Club Inc

Another newsletter that has helped set the standard in the micro hobbyist field is the *Analytical Engine*, the publication of the Chesapeake Microcomputer Club Inc, 236 St David Ct X-4, Cockeysville MD 21030, (301) 667-9690.

Those still looking for a basic Star Trek program might want to get hold of Volume 1, Number 6. They will also find an elementary article on kit building and another on assembling a five chip interface for those a little further along. The same issue contains a "Bibliography of Microprocessor Sources," as a handy reference of books, software, periodicals and articles. They also list similar bibliographies if this compendium isn't enough.

ON LINE – Hardware and Software Exchange

The *ON LINE* people continue to publish a listing of classifieds geared to the computer hobbyist: everything a hacker could want for sale or swap, you name it. There's also a listing of clubs, with meeting schedules. If you want to place an ad or if you're just looking for a bargain, send a note to *ON LINE*, D H Beetle, publisher, 24695 Santa Cruz Hwy, Los Gatos CA 95030.

Southern New England – Westchester – Fairfield

We often mention NECS, the New England Computer Society, in these pages; but New England is a fairly large area with more than its share of computer buffs, especially in its southern parts. If you're a

**SHORT COURSE
MICROCOMPUTERS:
PRINCIPLES AND APPLICATIONS**

EL PASO — JUAREZ

THE UNIVERSITY OF TEXAS
at EL PASO

MAY 23 — 27, 1977

Four day course plus Monday evening introductory sessions. Course stresses both hardware and software considerations of the design and application of microprocessors to real world problems. The course begins at an introductory level and includes programming considerations, I/O programming and design, memory module architecture, system evaluation, cost analysis, and a general discussion of applications. The lecture topics will be illustrated using laboratory workshops.

TUITION

\$375

WHICH INCLUDES:

**NOTES, CLASS MATERIALS,
AND
TUESDAY EVENING FIESTA**

For additional information
call or write

Dr. Glenn A. Gibson

**Electrical Engineering Department
The University of Texas at El Paso
El Paso, Texas 79968
(915) — 747-5472**

the microcomputer

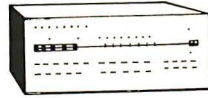

an introduction to
reality
now in canada:

imsai
processor
cromemco
tdl
and more

The Computer Place
186 Queen St. W
Toronto M5V 1Z1
416-598-0262

Focus Scientific
160 Elgin St.
Ottawa K2P 2C4
613-236-7767

OFF LEASE EQUIPMENT

Teletype ASR 33

\$809 each

F.O.B. Your local A J service center.



Modems and Couplers
also available.



521 Charcot Ave, San Jose
California 95131
(408) 263-8520

RF MODULATOR KIT



KIT INCLUDES:

Modulator (Cb3, Cb4) Battery Clip
60Db Switch On/Off Switch
8Ft. RF Cable Instructions
4Ft. Video Cable

• Limited Supply •

\$24.95 + \$1 Postage & Handling
(Calif. Residents add 6 1/2% Tax)



South Florida

Across from the University of Miami

University Shopping Center

1238A South Dixie Highway

Coral Gables, FL 33146

(305) 661-6042



SUNNY COMPUTER STORES, INC.

South Florida's First Computer Store

We Carry:

- IMSAI, COMPUCOLOR, VECTOR, SOUTHWEST, C.S.C., CROMEMCO VECTOR GRAPHIC, SEALS
- Books, Magazines, Newspapers
- Sockets, IC's, Printers
- Digital Cassette Equipment
- Debugging Equipment

We offer Classes, Friendly Advice and Service

Hours: Monday — 12 Noon to 9 P.M.

Tuesday through Saturday —

10 A.M. to 6 P.M.

U. S. ROBOTICS

Makers of fine robots since 1982.
announce the next best thing in 1977
the

**AUTO — ANSWER
MODEM**

* originate/answer switch means your micro can answer calls from other computers or terminals.

Build your own timesharing service.
(make your hobby pay)

Start a software exchange.

Enjoy a new dimension in games:
man/machine teams in battle!

* fully assembled and tested.

* 103 type, runs 0-600 baud.

* interface with RS232, 20ma and TTL.

* digital modem, crystal controlled.

* 90-day full warranty.

* optional \$25/yr maintenance contract.

* 10-day modem-back-money-back guarantee.

Send **\$105** (shipping, handling and Illinois sales tax included) to

U. S. ROBOTICS, INC.

Box 5502

Chicago, IL 60680

Phone: 312-528-9045

Connecticut or Westchester hacker, you might want to drop a line to one of these addresses: Southern New England Computer Society, 257 Willow St, New Haven CT 06511; Connecticut Microists, 8612 Wendy Ln, Westport CT 06800; or Westchester-Fairfield Amateur Computer Society, RR 1, POB 198, Pound Ridge NY 10576.

Japan

Thanks to the Homebrew Computer Club in Mountain View CA, we have a rather exotic address: that of the Japan Micro-computer Club. Those visiting that part of the world may want to stop in at the First Ohkura Building, 4f 2-1 Nihoubashi, Chuo-ku Tokyo JAPAN.

CACHE Register, Chicago

The Chicago Area Computer Hobbyists Exchange continues to publish *CACHE Register*, a newsletter that seems to lean toward abstract information on hardware and software; that is, there is very little editorializing, just the facts.

The people at CACHE are always glad to lend a hand to the hobbyist who needs information of any kind. Write to CACHE, POB 36, Vernon Hills IL 60061.

Minnesota Computer Society

We've had some correspondence from a new group (new at least to BYTE), the Minnesota Computer Society. Those in the Twin Cities area who would like to get together with other hackers should drop a line to MCS, POB 35317, Minneapolis MN 55435.

The Association of Time-Sharing Users

Here's a unique and really useful group for those involved in timesharing. AT/SU is dedicated to organizing and providing information and a forum for the users and industry representatives of remote computing. They publish a newsletter, *Interactive Computing Press Review*, a compilation of pertinent articles from various sources; *Interactive Computing Directory*, a two volume directory of remote computing users and suppliers updated with each newsletter; and *Special Reports*, a consumer's guide to timesharing services. Write the Association of Time-Sharing Users Inc, 75 Manhattan Dr, Boulder CO 80303.

Philadelphia Area Computer Society

PACS is publishing a newsletter called *THE DATA BUS*. Among the features is a reprint of Dr Lance Leventhal's fine series of tutorial articles on microprocessors, begin-

ning in November. Bill Goble is writing a three piece article entitled "Small Computer Bus Structure," which promises to be a fairly comprehensive series on bus signals and receiving and transmitting the bus. For information concerning the Philadelphia Area Computer Society and *THE DATA BUS*, get in touch with Bill McGill, University of Pennsylvania, Moore School Computing Facility D-2, Philadelphia PA 19174.

Mobile, Alabama — Anyone Interested in . . .

. . . SOL-10 Terminal Computers? R Downs is and he's looking for other folks who are, too. Contact Mr Downs at 205 Shelton Beach Rd, #53, Saraland AL 36571.

New York Amateur Computer Club

Hackers in and around "Fun City" might want to look into the advantages of joining the New York Amateur Computer Club in care of R Schwartz, 1E 375 Riverside Dr, New York NY 10025.

Ottawa

The Ottawa Computer Group has grown to substantial proportions in a rather short time. To get in on their doings, stop in at the National Research Council, 100 Sussex Dr, Ottawa, on the first Monday of the month or write POB 13218, Kanata Ontario, CANADA K2K 1X4, (613) 233-9412.

St Louis Area Computer Club

The St Louis Area Computer Club met recently for the first time, attracting hackers from both sides of the Mississippi. Apparently we have a real mix here of ages, vocations and obscure computers. To find out more, contact Lou Elkins, POB 1143, St Louis MO 63188, (314) 427-6116.

Panhandle Computer Society

We've just received word that a new computer club has formed, The Panhandle Computer Society of Amarillo TX. They meet every Friday and boast a membership of more than 30. All inquiries should be addressed to Tex Everett, 2923 S Spring, Amarillo TX 79103, or call (806) 373-8307.

A Note from Sol Libes re a National Personal Computing Society

I have just finished reading "Some Notes on Clubs" in the August 1976 issue, page 4, and must take exception to the statements you attributed to me. I fear there must have been a misunderstanding in our discussions. I certainly did not say, in regard to a national organization: "Who needs it?", etc.

Clubs and Newsletters information should be sent to BYTE, 70 Main St, Peterborough NH 03458, attention Peter Travisano.

BABY! I MICROCOMPUTER

I frankly feel there is a need for a national organization similar to ARRL. There are many reasons for it. Primary among them is the need to develop standards, both for hardware and software. We are currently faced with the problems of many manufacturers going their own way in equipment and program design and hence a great deal of noncompatibility. This causes unnecessary expenses for the amateur user. For example; we currently have more than a dozen different cassette IO systems which are not compatible. This greatly inhibits the exchange of software in cassette form. Adherence to one recording standard would eliminate this problem.

A single club, or regional organization, is not in a position to develop standards and influence their adoption. This can only be done by a national organization.

Sol Libes, President
Amateur Computer Group of NJ
UCT1
1776 Raritan Rd
Scotch Plains NJ 07076

Sorry about the misunderstanding, Sol. I came away with the impressions printed in that issue . . . CH.■

ARE YOU BUYING A SYSTEM?

BEFORE YOU DO

SEND FOR OUR LITERATURE.
COMPARE OUR SPECIFICATIONS WITH OUR COMPETITORS' KITS AND ASSEMBLED SYSTEMS!

YOU WILL SEE

THE BABY! I SYSTEM IS NOT A BABY WHEN IT COMES TO HARDWARE AND PERFORMANCE

BUT IT IS WHEN IT COMES TO

PRICE!

COMPARE TODAY

THEN BUY A

BABY! I MICROCOMPUTER

STM SYSTEMS, INC.

P.O. BOX 248

MONT VERNON, N.H. 03057

603-673-2581



Not just a pretty face:

Morrow's presents a front panel with brains--- \$249.95

Combination front panel and CPU board speeds program development and debugging

Replaces and upgrades ALTAIR/IMSAI front panel and CPU boards, or forms the nucleus of a custom system.

This isn't a toy...or a conversation piece...but a tool for serious program development, rivalling the sophistication of many minicomputer systems. Granted no system can make bugs go away: but this one, finally, makes them manageable.

Two exclusive operating modes give you control over real time, allowing you to work on a program while it's running.

The "Control Halt" mode refuses to let the 8080A CPU go dormant upon executing a HALT instruction; instead, special purpose hardware forces a NO OP instruction then passes control to the front panel program, where you can examine and alter processor registers...memory locations...and I/O ports directly from the front panel.

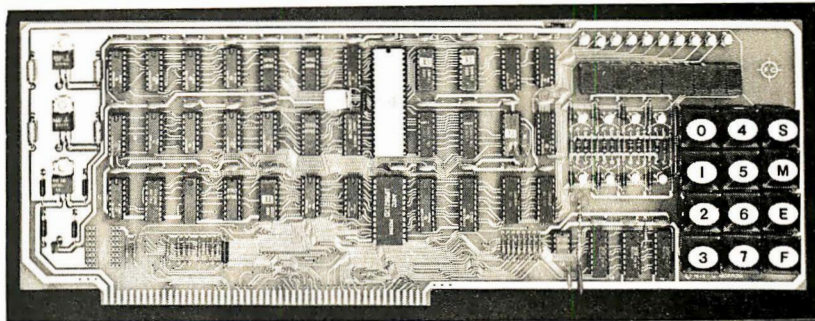

The "Slow Step" mode allows you to run through a program at a variable rate from 1 to 65,000 steps per minute. The display indicates the program counter and a processor register of your choice.

Unambiguous readouts replace blinking LEDs; a 12 pad keyboard replaces time-consuming toggle switches. And because the front panel/CPU is Altair buss compatible, you can build a custom system around this board using Altair compatible peripherals. Also compatible with any software written for an Altair type buss.

We've made some strong claims in this ad--- and given the way some companies advertise, you have a right to be skeptical. In order to dispel any doubts, we've put together a complete documentation packet (schematic, layout, software, assembly instructions), available for \$5.00 postpaid. You may be surprised to find out we've understated our case.

MORROW'S BOX 6194
ALBANY, CA 94706
Micro-STUFF



BYTE's Bits

Jim Warren's Official Rumors About the West Coast Computer Faire . . .

In phone conversation January 5 of this year, Jim Warren mentioned some of the plans for the banquets which will be held during the First West Coast Computer Faire. On Friday and Saturday night of the event, there will be speakers. Each night's offering will represent one speaker about the future world, and one speaker commenting about the real world of today. On Friday April 15, the real world speaker will be John Whitney, the computer animation and graphics artist who provided a fascinating show at the Personal Computing 76 show in Atlantic City last fall. The future world speaker on Friday night will be Frederik Pohl, one of the better known contemporary science fiction writers. On Saturday April 16, the real world speaker is Dr Henry Tropp, who will speak about his recently completed research project on the history of computing, commissioned by the Smithsonian Institution. The future world speaker for Saturday's banquet had not been finalized as of the time this note was written. ■

Want a Used Computer?

Believe it or not, there exists the friendly local used computer broker — and there are enough of these fellows around apparently (13 in 13 different cities) to warrant a somewhat classy service organization run by Arthur F Phinney and called the Computer Multiple Listing Service, located at 3212 Chichester Ln, Fairfax VA 22030. This organization puts out a 16 page pamphlet which describes some of the mechanics of computer brokerage and the ways in which computer purchases can be arranged. We wouldn't expect much traffic in \$2000 personal systems here, but if you want to look into a bargain price for a model X big computer this might be the place to start. ■

Notes on "What Is It?"

In December 1976 BYTE we ran a little query on page 96 concerning a cross section of an unidentified product. The answer appeared in the January 1977 issue of BYTE on page 104. The question elicited several responses, but only one correct response. Floyd Largent, of the Abex Corporation, Engineered Products Division, Mill St, Athens OH 45701 writes: "The product in your "What Is It" photograph is a porous plastic used to hold ink for computer printout devices."

But some of the wrong answers were just as interesting as the picture itself.

Attention Manufacturers

Personal computing equipment manufacturers and suppliers are invited to participate in the 1977 National Computer Conference personal computing exposition to be held in Dallas TX, June 13-16. The NCC, sponsored by the American Federation of Information Processing Societies Inc (AFIPS) and four of its member societies, will be the year's largest gathering of data processing users and computer professionals.

Full information on the Personal Computing Exposition, including brochure, floor plan, and application forms, is available from the AFIPS Exhibit Sales Office, 210 Summit Av, Montvale NJ 07645, (201) 391-9810.

The 77 NCC, recognizing the size and importance of the personal computing market, will feature a commercial exhibition by equipment manufacturers and suppliers of personal computing products and services. The Personal Computing Exposition will be in the North Hall of the Dallas Convention Center one level below the main NCC exhibit hall. Reservations for linear booths (minimum size 10 feet by 10 feet at a cost of \$600) are currently being accepted. As a special service to participating exhibitors, packaged booth displays are being made available as part of the overall cost.

In addition to the Personal Computing Exposition, the NCC will also feature a Personal Computing Fair where individuals and groups will display non-commercial systems and equipment. Personal computing will also be covered in a variety of NCC events including a two day program of sessions, and a computer club congress. ■

Two people identified the item as a scanning electron microscope picture of a printed circuit board. One person identified it as an electron microscope picture of "the actual atomic lattice of a conducting material, copper wire or something . . ." (Only problem: Resolution for typical electron energies is just not that good.) One person opined that it was "an experimental optical read only memory consisting of microencapsulated spheres of a black fluid sandwiched between two transparent planes. A relatively high power beam of light is used to write bits by exploding a sphere containing the fluid, while a low power beam reads the blots created as bits." Another identified it as a cross section of a bubble memory. The most common answer, which actually is not far from the mark, was that the picture was a cross section of the commonly used conductive foam in which integrated circuits come packaged. In appearance, it is probable that a closeup photo of such foam might indeed look very similar to the photomicrograph of the inking matrix.

We extended Floyd's BYTE subscription by one year as an informal prize on this informal contest. ■

Programmers Invited to Participate in 1977 National Computer Conference Programming Contest

This announcement arrived two days after the February BYTE was on the press, but if you hurry, you'll be able to meet the March 1 deadline . . . by writing your own "official entry form" as well as the contest entry.

Programmers who attend the 1977 National Computer Conference, June 13-16, in Dallas TX will have an opportunity to participate in the 1977 NCC National Programming Contest. All contestants will be competing for prizes, trophies, and plaques, as well as the chance to gain the title of "1977 National Champion Programmer."

According to Dr Portia Isaacson of the University of Texas at Dallas, 1977 NCC chairperson, "The 77 NCC special activities committee has organized this 'first' National Programming Contest in an effort to involve computer professionals more directly in conference activities. Approximately 240 applicants will be selected to participate in a test of logic and programming skills."

Directing plans for the contest is Dr C E Rodriguez of East Texas State University. Dr Rodriguez reports that there will be no requirement for a particular programming language. Entrants selected will receive a list of specific languages, terminals, and time-sharing services to be used in the contest. Contestants will be selected based on the quality of their solutions to a sample problem which will be made available on request.

Deadline for all entries is a postmark no later than March 1 1977. Official entry forms and sample problems may be obtained by writing Dr C E Rodriguez, Computer Science Dept, East Texas State University, Commerce TX 75428. ■

A New Virginia Polytechnic Institute Seminar Program

David G Larsen forwards these two notices of a new series of microprocessor related seminars to be held at VPI in June of this year:

Microcomputer Interfacing Workshop, June 9, 10, 11, 1977.

A three day workshop based on the popular microprocessor. Over 20 operating 8080 computers are available for participant use.

Digital Electronics for Automation Workshop, June 7, 8, 1977.

A two day workshop based on the small scale and medium scale TTL integrated circuits. Many hours of laboratory time with individual breadboarding stations will be provided along with indepth lectures.

For more information on these workshops contact Dr Norris Bell, VPI and SU Continuing Education Center, Blacksburg VA 24061, (703) 951-6328. ■

Advanced Microcomputer Products Presents

Prototype Design Equipment



IC SOCKETS AND BUS STRIPS
 Original breakthrough in prototyping. The Q-Tube™ permits fast, easy installation of ICs. The Q-Tube™ is made of a special plastic that is non-conductive, non-flammable, and non-toxic. It is available in a variety of sizes to accommodate all IC packages. The Q-Tube™ is also available in a variety of colors to help you identify your ICs. The Q-Tube™ is the only socket that is designed to be used with a breadboard. The Q-Tube™ is the only socket that is designed to be used with a prototyping board. The Q-Tube™ is the only socket that is designed to be used with a prototyping board.

Q-Tube™	Length	Width	Height	Part No.
Q-Tube™	1.00"	0.50"	0.25"	Q-TUBE-100
Q-Tube™	1.50"	0.50"	0.25"	Q-TUBE-150
Q-Tube™	2.00"	0.50"	0.25"	Q-TUBE-200
Q-Tube™	2.50"	0.50"	0.25"	Q-TUBE-250
Q-Tube™	3.00"	0.50"	0.25"	Q-TUBE-300
Q-Tube™	3.50"	0.50"	0.25"	Q-TUBE-350
Q-Tube™	4.00"	0.50"	0.25"	Q-TUBE-400
Q-Tube™	4.50"	0.50"	0.25"	Q-TUBE-450
Q-Tube™	5.00"	0.50"	0.25"	Q-TUBE-500
Q-Tube™	5.50"	0.50"	0.25"	Q-TUBE-550
Q-Tube™	6.00"	0.50"	0.25"	Q-TUBE-600
Q-Tube™	6.50"	0.50"	0.25"	Q-TUBE-650
Q-Tube™	7.00"	0.50"	0.25"	Q-TUBE-700
Q-Tube™	7.50"	0.50"	0.25"	Q-TUBE-750
Q-Tube™	8.00"	0.50"	0.25"	Q-TUBE-800
Q-Tube™	8.50"	0.50"	0.25"	Q-TUBE-850
Q-Tube™	9.00"	0.50"	0.25"	Q-TUBE-900
Q-Tube™	9.50"	0.50"	0.25"	Q-TUBE-950
Q-Tube™	10.00"	0.50"	0.25"	Q-TUBE-1000

PRO-BOARD™ UNIT
 All the speed and precision of Q-Tube™ sockets and bus strips in one unit. The Pro-Board™ is a complete prototyping system that includes everything you need to get started. The Pro-Board™ is available in a variety of sizes to accommodate all IC packages. The Pro-Board™ is also available in a variety of colors to help you identify your ICs. The Pro-Board™ is the only prototyping system that is designed to be used with a breadboard. The Pro-Board™ is the only prototyping system that is designed to be used with a prototyping board. The Pro-Board™ is the only prototyping system that is designed to be used with a prototyping board.

Pro-Board™	Length	Width	Height	Part No.
Pro-Board™	1.00"	0.50"	0.25"	PRO-BOARD-100
Pro-Board™	1.50"	0.50"	0.25"	PRO-BOARD-150
Pro-Board™	2.00"	0.50"	0.25"	PRO-BOARD-200
Pro-Board™	2.50"	0.50"	0.25"	PRO-BOARD-250
Pro-Board™	3.00"	0.50"	0.25"	PRO-BOARD-300
Pro-Board™	3.50"	0.50"	0.25"	PRO-BOARD-350
Pro-Board™	4.00"	0.50"	0.25"	PRO-BOARD-400
Pro-Board™	4.50"	0.50"	0.25"	PRO-BOARD-450
Pro-Board™	5.00"	0.50"	0.25"	PRO-BOARD-500
Pro-Board™	5.50"	0.50"	0.25"	PRO-BOARD-550
Pro-Board™	6.00"	0.50"	0.25"	PRO-BOARD-600
Pro-Board™	6.50"	0.50"	0.25"	PRO-BOARD-650
Pro-Board™	7.00"	0.50"	0.25"	PRO-BOARD-700
Pro-Board™	7.50"	0.50"	0.25"	PRO-BOARD-750
Pro-Board™	8.00"	0.50"	0.25"	PRO-BOARD-800
Pro-Board™	8.50"	0.50"	0.25"	PRO-BOARD-850
Pro-Board™	9.00"	0.50"	0.25"	PRO-BOARD-900
Pro-Board™	9.50"	0.50"	0.25"	PRO-BOARD-950
Pro-Board™	10.00"	0.50"	0.25"	PRO-BOARD-1000

PRO-BOARD™ UNIT
 Contains ten pre-mounted Q-Tube™ sockets and ten pre-mounted bus strips. The Pro-Board™ is a complete prototyping system that includes everything you need to get started. The Pro-Board™ is available in a variety of sizes to accommodate all IC packages. The Pro-Board™ is also available in a variety of colors to help you identify your ICs. The Pro-Board™ is the only prototyping system that is designed to be used with a breadboard. The Pro-Board™ is the only prototyping system that is designed to be used with a prototyping board. The Pro-Board™ is the only prototyping system that is designed to be used with a prototyping board.

PRO-BOARD™ UNIT
 Contains ten pre-mounted Q-Tube™ sockets and ten pre-mounted bus strips. The Pro-Board™ is a complete prototyping system that includes everything you need to get started. The Pro-Board™ is available in a variety of sizes to accommodate all IC packages. The Pro-Board™ is also available in a variety of colors to help you identify your ICs. The Pro-Board™ is the only prototyping system that is designed to be used with a breadboard. The Pro-Board™ is the only prototyping system that is designed to be used with a prototyping board. The Pro-Board™ is the only prototyping system that is designed to be used with a prototyping board.



LOGIC PROBE LP-1
 A new logic probe with built-in LED indicator. The Logic Probe LP-1 is a complete prototyping system that includes everything you need to get started. The Logic Probe LP-1 is available in a variety of sizes to accommodate all IC packages. The Logic Probe LP-1 is also available in a variety of colors to help you identify your ICs. The Logic Probe LP-1 is the only logic probe that is designed to be used with a breadboard. The Logic Probe LP-1 is the only logic probe that is designed to be used with a prototyping board. The Logic Probe LP-1 is the only logic probe that is designed to be used with a prototyping board.

NEW SOCKETS & BUS STRIPS
 Experiment 600 \$10.95
 Experiment 300 \$9.95
 *Copies of expanded catalog available for \$1.00.

PRO-BOARD™ UNIT
 Experiment 600 \$10.95
 Experiment 300 \$9.95
 *Copies of expanded catalog available for \$1.00.

PRO-BOARD™ UNIT
 Experiment 600 \$10.95
 Experiment 300 \$9.95
 *Copies of expanded catalog available for \$1.00.

WE ARE A FULL LINE CSC DISTRIBUTOR. WE CAN SUPPLY ANY PRODUCT OUT OF THE CSC CATALOGUE. IF YOU NEED THEIR LATEST CATALOGUE WRITE AND WE'LL SEND IT ALONG.

TRANSISTORS

P/N	DESCRIPTION	PKG.	UNIT PRICE	100	1000
2N1818	NPN High Frequency	T0-18	.24	17	16
2N1820	NPN General Purpose	T0-18	.24	17	16
2N2219A	NPN General Purpose	T0-18	.24	17	16
2N2904A	NPN PNP General Purpose	T0-18	.22	20	18
2N2907A	NPN PNP General Purpose	T0-18	.22	17	16
2N3041	NPN Small Signal PNP	T0-18	.24	17	16
2N3043	NPN Small Signal PNP	T0-18	.24	17	16
2N3055	NPN Low Level Power	T0-18	.24	16	14
2N3063	NPN Small Signal PNP	T0-18	.24	16	14
2N3064	NPN Small Signal PNP	T0-18	.24	16	14
2N3065	NPN Small Signal PNP	T0-18	.24	16	14
2N3066	NPN Small Signal PNP	T0-18	.24	16	14
2N3067	NPN Small Signal PNP	T0-18	.24	16	14
2N3068	NPN Small Signal PNP	T0-18	.24	16	14
2N3069	NPN Small Signal PNP	T0-18	.24	16	14
2N3070	NPN Small Signal PNP	T0-18	.24	16	14
2N3071	NPN Small Signal PNP	T0-18	.24	16	14
2N3072	NPN Small Signal PNP	T0-18	.24	16	14
2N3073	NPN Small Signal PNP	T0-18	.24	16	14
2N3074	NPN Small Signal PNP	T0-18	.24	16	14
2N3075	NPN Small Signal PNP	T0-18	.24	16	14
2N3076	NPN Small Signal PNP	T0-18	.24	16	14
2N3077	NPN Small Signal PNP	T0-18	.24	16	14
2N3078	NPN Small Signal PNP	T0-18	.24	16	14
2N3079	NPN Small Signal PNP	T0-18	.24	16	14
2N3080	NPN Small Signal PNP	T0-18	.24	16	14
2N3081	NPN Small Signal PNP	T0-18	.24	16	14
2N3082	NPN Small Signal PNP	T0-18	.24	16	14
2N3083	NPN Small Signal PNP	T0-18	.24	16	14
2N3084	NPN Small Signal PNP	T0-18	.24	16	14
2N3085	NPN Small Signal PNP	T0-18	.24	16	14
2N3086	NPN Small Signal PNP	T0-18	.24	16	14
2N3087	NPN Small Signal PNP	T0-18	.24	16	14
2N3088	NPN Small Signal PNP	T0-18	.24	16	14
2N3089	NPN Small Signal PNP	T0-18	.24	16	14
2N3090	NPN Small Signal PNP	T0-18	.24	16	14
2N3091	NPN Small Signal PNP	T0-18	.24	16	14
2N3092	NPN Small Signal PNP	T0-18	.24	16	14
2N3093	NPN Small Signal PNP	T0-18	.24	16	14
2N3094	NPN Small Signal PNP	T0-18	.24	16	14
2N3095	NPN Small Signal PNP	T0-18	.24	16	14
2N3096	NPN Small Signal PNP	T0-18	.24	16	14
2N3097	NPN Small Signal PNP	T0-18	.24	16	14
2N3098	NPN Small Signal PNP	T0-18	.24	16	14
2N3099	NPN Small Signal PNP	T0-18	.24	16	14
2N3100	NPN Small Signal PNP	T0-18	.24	16	14

BRIDGES

	199	100499	500999
W2M1	75A 200V	74	40
W2M2	75A 50V	70	34
W2M3	75A 100V	70	34
W2M4	75A 200V	70	34
W2M5	75A 500V	70	34
W2M6	75A 1000V	70	34
W2M7	75A 2000V	70	34
W2M8	75A 5000V	70	34
W2M9	75A 10000V	70	34
W2M10	75A 20000V	70	34
W2M11	75A 50000V	70	34
W2M12	75A 100000V	70	34
W2M13	75A 200000V	70	34
W2M14	75A 500000V	70	34
W2M15	75A 1000000V	70	34
W2M16	75A 2000000V	70	34
W2M17	75A 5000000V	70	34
W2M18	75A 10000000V	70	34
W2M19	75A 20000000V	70	34
W2M20	75A 50000000V	70	34
W2M21	75A 100000000V	70	34
W2M22	75A 200000000V	70	34
W2M23	75A 500000000V	70	34
W2M24	75A 1000000000V	70	34
W2M25	75A 2000000000V	70	34
W2M26	75A 5000000000V	70	34
W2M27	75A 10000000000V	70	34
W2M28	75A 20000000000V	70	34
W2M29	75A 50000000000V	70	34
W2M30	75A 100000000000V	70	34
W2M31	75A 200000000000V	70	34
W2M32	75A 500000000000V	70	34
W2M33	75A 1000000000000V	70	34
W2M34	75A 2000000000000V	70	34
W2M35	75A 5000000000000V	70	34
W2M36	75A 10000000000000V	70	34
W2M37	75A 20000000000000V	70	34
W2M38	75A 50000000000000V	70	34
W2M39	75A 100000000000000V	70	34
W2M40	75A 200000000000000V	70	34
W2M41	75A 500000000000000V	70	34
W2M42	75A 1000000000000000V	70	34
W2M43	75A 2000000000000000V	70	34
W2M44	75A 5000000000000000V	70	34
W2M45	75A 10000000000000000V	70	34
W2M46	75A 20000000000000000V	70	34
W2M47	75A 50000000000000000V	70	34
W2M48	75A 100000000000000000V	70	34
W2M49	75A 200000000000000000V	70	34
W2M50	75A 500000000000000000V	70	34
W2M51	75A 1000000000000000000V	70	34
W2M52	75A 2000000000000000000V	70	34
W2M53	75A 5000000000000000000V	70	34
W2M54	75A 10000000000000000000V	70	34
W2M55	75A 20000000000000000000V	70	34
W2M56	75A 50000000000000000000V	70	34
W2M57	75A 100000000000000000000V	70	34
W2M58	75A 200000000000000000000V	70	34
W2M59	75A 500000000000000000000V	70	34
W2M60	75A 1000000000000000000000V	70	34
W2M61	75A 2000000000000000000000V	70	34
W2M62	75A 5000000000000000000000V	70	34
W2M63	75A 10000000000000000000000V	70	34
W2M64	75A 20000000000000000000000V	70	34
W2M65	75A 50000000000000000000000V	70	34
W2M66	75A 100000000000000000000000V	70	34
W2M67	75A 200000000000000000000000V	70	34
W2M68	75A 500000000000000000000000V	70	34
W2M69	75A 1000000000000000000000000V	70	34
W2M70	75A 2000000000000000000000000V	70	34
W2M71	75A 5000000000000000000000000V	70	34
W2M72	75A 10000000000000000000000000V	70	34
W2M73	75A 20000000000000000000000000V	70	34
W2M74	75A 50000000000000000000000000V	70	34
W2M75	75A 100000000000000000000000000V	70	34
W2M76	75A 200000000000000000000000000V	70	34
W2M77	75A 500000000000000000000000000V	70	34
W2M78	75A 1000000000000000000000000000V	70	34
W2M79	75A 2000000000000000000000000000V	70	34
W2M80	75A 5000000000000000000000000000V	70	34
W2M81	75A 10000000000000000000000000000V	70	34
W2M82	75A 20000000000000000000000000000V	70	34
W2M83	75A 50000000000000000000000000000V	70	34
W2M84	75A 100000000000000000000000000000V	70	34
W2M85	75A 200000000000000000000000000000V	70	34

CALIFORNIA INDUSTRIAL

Post Office Box 3097 B • Torrance, California 90503



SPERRY UNIVAC KEYBOARD

The famous Sperry Univac 1710 Hollerith keyboard assembly is now available from California Industrial for only \$24.88. The ideal computer input device for accountants and mathematicians. The numeric keys are placed on the lower three rows to resemble a ten key adding machine. This format allows one handed numeric data entry. Original cost was \$385. Used but guaranteed in excellent condition. Complete with documentation.

\$24.88
Univac

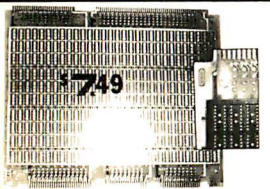

Wire Wrap Project Board
The ideal prototype board for those one of a kind projects. Each board accommodates 300 integrated circuits.

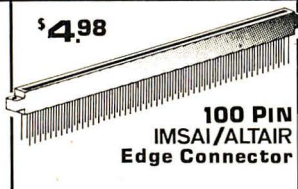

\$4.98
100 PIN IMSAI/ALTAIR Edge Connector
Altair, Imsai compatible gold plated, dual 50 (125 centers) three tier wire wrap edge connector. 3 for \$13.50



\$17.50 **63 key KEYBOARD**
Uncoded computer keyboard. Contains: 63 reliable gold plated SPST switches. ASCII Kit components and printed circuit board. \$35.00 additional.

JOYSTICK \$5.50



This joystick feature four 100K potentiometers, that vary resistance proportional to the angle of the stick. Perfect for television games, quad stereo and radio controlled aircraft.

POWER SUPPLIES

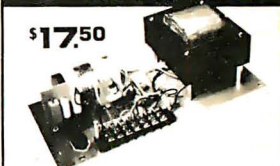

\$17.50
5 volt 2.2 Amp regulated power supply. Also delivers 12 volts at 4 Amps unregulated. Perfect for TTL applications.



Power Transformer
\$4.98
Input 117vac. Output-21v 5A center tapped. Suitable for 12v, 5A, or 5v, 10A power supply. Four other windings at lower currents.



CALCULATOR KEYBOARD
\$2.98
Ideal for keyless entry systems, burglar alarms. Touch Tone or hexadecimal computer input code.



\$3.98 Digital Clock
Manufactured for the Panasonic clock radio. The clock mechanism trips a microswitch upon reaching your preset wake-up time.



DIGITAL Thermometer **\$2.98**
Liquid crystal digital display. Your choice, Fahrenheit or centigrade. Both for \$5.00



BRIDGE RECTIFIER
\$2.50
MOTOROLA 27 Amp. 200v.

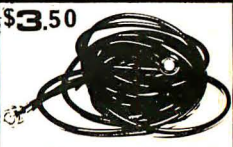

BNC CABLE **\$3.50**
15 feet of RG-58U connector at ends

TTL As Low As \$09*

7400	09	7476	39
7401	19	7479	39
7402	19	7480	79
7403	19	7482	99
7404	19	7483	99
7405	19	7485	99
7406	19	7486	49
7407	25	7488	340
7408	25	7489	279
7409	25	7490	49
7410	25	7491	99
7411	25	7492	49
7412	25	7493	49
7413	25	7494	79
7414	25	7495	79
7415	25	7496	79
7416	25	7497	399
7417	25	7498	119
7420	19	7499	79
7422	49	7500	39
7423	39	7501	49
7425	39	7502	49
7426	39	7503	49
7427	39	7504	49
7428	49	7505	49
7429	39	7506	49
7430	39	7507	49
7431	39	7508	49
7432	39	7509	49
7433	39	7510	49
7434	39	7511	49
7435	39	7512	49
7436	39	7513	49
7437	39	7514	49
7438	39	7515	49
7439	39	7516	49
7440	39	7517	49
7441	39	7518	49
7442	39	7519	49
7443	39	7520	49
7444	39	7521	49
7445	39	7522	49
7446	39	7523	49
7447	39	7524	49
7448	39	7525	49
7449	39	7526	49
7450	39	7527	49
7451	39	7528	49
7452	39	7529	49
7453	39	7530	49
7454	39	7531	49
7455	39	7532	49
7456	39	7533	49
7457	39	7534	49
7458	39	7535	49
7459	39	7536	49
7460	39	7537	49
7461	39	7538	49
7462	39	7539	49
7463	39	7540	49
7464	39	7541	49
7465	39	7542	49
7466	39	7543	49
7467	39	7544	49
7468	39	7545	49
7469	39	7546	49
7470	39	7547	49
7471	39	7548	49
7472	39	7549	49
7473	39	7550	49
7474	39	7551	49
7475	39	7552	49

74164	1.19	4049	79	79	79	MEMORY
74165	1.19	4050	79	79	79	
74166	1.19	4051	1.99	1.99	1.99	
74167	4.99	4052	1.49	1.49	1.49	
74170	2.49	4053	2.19	2.19	2.19	1702 9.95
74171	1.49	4054	3.19	3.19	3.19	82s23 2.95
74172	1.19	4055	1.19	1.19	1.19	2102 1.79
74173	1.19	4056	1.19	1.19	1.19	2102-1 1.89
74174	1.19	4057	1.19	1.19	1.19	2102-2 1.89
74175	99	4058	49	49	49	
74176	99	4059	49	49	49	
74177	99	4060	49	49	49	
74178	99	4061	49	49	49	
74179	99	4062	49	49	49	
74180	99	4063	49	49	49	
74181	2.49	4064	49	49	49	
74182	99	4065	49	49	49	
74183	99	4066	49	49	49	
74184	1.99	4067	49	49	49	
74185	1.99	4068	49	49	49	
74186	4.99	4069	49	49	49	
74187	1.19	4070	49	49	49	
74188	1.19	4071	49	49	49	
74189	1.19	4072	49	49	49	
74190	1.19	4073	49	49	49	
74191	1.19	4074	49	49	49	
74192	99	4075	49	49	49	
74193	99	4076	49	49	49	
74194	99	4077	49	49	49	
74195	99	4078	49	49	49	
74196	1.19	4079	49	49	49	
74197	1.19	4080	49	49	49	
74198	1.19	4081	49	49	49	
74199	1.19	4082	49	49	49	
74200	1.19	4083	49	49	49	
74201	1.19	4084	49	49	49	
74202	1.19	4085	49	49	49	
74203	1.19	4086	49	49	49	
74204	1.19	4087	49	49	49	
74205	1.19	4088	49	49	49	
74206	1.19	4089	49	49	49	
74207	1.19	4090	49	49	49	
74208	1.19	4091	49	49	49	
74209	1.19	4092	49	49	49	
74210	1.19	4093	49	49	49	
74211	1.19	4094	49	49	49	
74212	1.19	4095	49	49	49	
74213	1.19	4096	49	49	49	
74214	1.19	4097	49	49	49	
74215	1.19	4098	49	49	49	
74216	1.19	4099	49	49	49	
74217	1.19	4100	49	49	49	
74218	1.19	4101	49	49	49	
74219	1.19	4102	49	49	49	
74220	1.19	4103	49	49	49	
74221	1.19	4104	49	49	49	
74222	1.19	4105	49	49	49	
74223	1.19	4106	49	49	49	
74224	1.19	4107	49	49	49	
74225	1.19	4108	49	49	49	
74226	1.19	4109	49	49	49	
74227	1.19	4110	49	49	49	
74228	1.19	4111	49	49	49	
74229	1.19	4112	49	49	49	
74230	1.19	4113	49	49	49	
74231	1.19	4114	49	49	49	
74232	1.19	4115	49	49	49	
74233	1.19	4116	49	49	49	
74234	1.19	4117	49	49	49	
74235	1.19	4118	49	49	49	
74236	1.19	4119	49	49	49	
74237	1.19	4120	49	49	49	
74238	1.19	4121	49	49	49	
74239	1.19	4122	49	49	49	
74240	1.19	4123	49	49	49	
74241	1.19	4124	49	49	49	
74242	1.19	4125	49	49	49	
74243	1.19	4126	49	49	49	
74244	1.19	4127	49	49	49	
74245	1.19	4128	49	49	49	
74246	1.19	4129	49	49	49	
74247	1.19	4130	49	49	49	
74248	1.19	4131	49	49	49	
74249	1.19	4132	49	49	49	
74250	1.19	4133	49	49	49	
74251	1.19	4134	49	49	49	
74252	1.19	4135	49	49	49	
74253	1.19	4136	49	49	49	
74254	1.19	4137	49	49	49	
74255	1.19	4138	49	49	49	
74256	1.19	4139	49	49	49	
74257	1.19	4140	49	49	49	
74258	1.19	4141	49	49	49	
74259	1.19	4142	49	49	49	
74260	1.19	4143	49	49	49	
74261	1.19	4144	49	49	49	
74262	1.19	4145	49	49	49	
74263	1.19	4146	49	49	49	
74264	1.19	4147	49	49	49	
74265	1.19	4148	49	49	49	
74266	1.19	4149	49	49	49	
74267	1.19	4150	49	49	49	
74268	1.19	4151	49	49	49	
74269	1.19	4152	49	49	49	
74270	1.19	4153	49	49	49	
74271	1.19	4154	49	49	49	
74272	1.19	4155	49	49	49	
74273	1.19	4156	49	49	49	
74274	1.19	4157	49	49	49	
74275	1.19	4158	49	49	49	
74276	1.19	4159	49	49	49	
74277	1.19	4160	49	49	49	

LM741 \$09*

300H	79	340T-24	1.79
301H	39	350N	99
302CN	39	351CN	85
302H	1.29	370A	1.29
304H	1.29	370N	1.29
305H	1.29	373N	3.19
307H	49	377H	3.99
307CN	39	380N	1.79
308H	69	381N	1.79
308CN	69	382N	1.79
309H	1.09	NE555v	49
310H	1.19	NE555P	39
310CN	1.19	NE555H	1.49
311H	1.19	NE565N	1.79
311CN	1.19	NE565P	1.25
312H	99	703CN	45
312CN	99	709H	39
313H	99	709CN	39
313CN	99	710N	79
314H	1.49	711H	39
314CN	1.49	711CN	39
315H	1.49	712H	39
315CN	1.49	713H	39
316H	1.49	713CN	39
316CN	1.49	714H	99
317H	1.49	714CN	99
317CN	1.49	715H	99
318H	1.49	715CN	99
318CN	1.49	716H	99

COMPUTER WAREHOUSE STORE

DEPT. B, 584 COMMONWEALTH AVE.
BOSTON, MA 02215 617/261-2701

SYKES COMPUCORDER 100

\$950 + \$35 SHIPPING

GREAT CASSETTE RECORDER OFFERS 3.6M BIT STORAGE. TRANSFER RATE OF 500 CH/SEC AT 1000 BPI. READ WRITE SPEED 5 IPS RECORDING BIT SERIAL. BIPHASE ENCODED WITH VARIABLE BLOCK LENGTHS UNDER PROGRAM CONTROL



TECHTRAN 4100 \$595

TAPE CASSETTE DRIVE + \$35 SHIPPING U.S. VERSATILITY PLUS IS YOURS WITH THIS ORIGINAL COST \$3200 DRIVE. JUST PLUG IT IN RS232. CAN RUN DIRECTLY FROM TERMINAL INDEPENDENT OF CPU. FULL EDIT CAPABILITY, ALL FUNCTIONS UNDER SOFTWARE CONTROL. LIMITED QUANTITY AVAILABLE

TALLY T132

7 x 8 DOT MATRIX IMPACT PRINTER HAS A SINGLE LINE DYNAMIC MEMORY AND A UNIVERSAL INTERFACE TO ACCEPT PARALLEL DATA, FORMS TO 14-7/8 IN. SIDE, SIMPLE PRINTING MECHANISM USES 132 SOLENOID HAMMERS AND TWO STEPPER MOTORS FOR 100 LPM, 132 COLUMNS, 64 CHARACTERS



\$950 + SHIPPING 150 lb.

COMPONENTS FOR SYSTEMS

FEATURES OF THE MONTH GREEN PHOSPHOR VIDEO MONITOR



TOP QUALITY CRTS FROM A MAJOR VENDOR ... NOT JUST A REWORKED TV SET. STANDARD 1V P TO P COMPOSITE VIDEO INPUT, 10 MHZ BAND WIDTH, RASTER SCAN 12 x 12 x 13 IN., WITH POWER SUPPLY VIDEO AMPLIFIER, DRIVING CIRCUITRY, VENTILATION MUFFIN FANS, 7 x 9 IN. HORIZONTAL VIEWING AREA UP TO 24 LINES x 80 CHAR., ANTIGLARE 1/4 IN. ETCHED GRADIENT DENSITY FACE PLATE. P39 GREEN PHOSPHOR FOR BETTER VIEWING EASE, ON/OFF BRIGHTNESS CONTROLS, 115VAC, 60 W. (SPOT SIZE .015 IN. NOMINAL) ... TRULY A COMMERCIAL UNIT BUILT TO WORK IN A DEMANDING ENVIRONMENT. WE'VE RUN THREE OF THESE OFF OUR SWTPC TERMINAL KIT AT ONCE FOR DEMONSTRATIONS.

\$150

25 SHIPPING

ALL anASR 33 is and MORE!

WE'VE SOLD OUT 3 TIMES ON THIS HEAVY-DUTY TELETYPEWRITER. THIS SHIPMENT IN GREAT CONDITION OFFERS RS232 INTERFACE, QUIET OPERATION, 10 CPS BUILT-IN PAPER TAPE PRINTER/PUNCH, ELECTRIC TYPEWRITER KEYBOARD WITH ADDITIONAL 10 KEY NUMERIC PAD, YOUR CHOICE OF FRICTION OR SPROCKET FEED, LIGHTED PLATEN AREA FOR EASY READING, STANDARD PAPER AND TAPE, SUPPORTED BY OLIVETTI, IMPACT PRINTER GOES UP TO 6 COPIES, VERTICAL SPACING ADJUSTABLE.

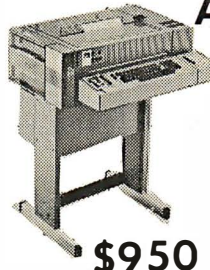

\$950

+ SHIPPING 165 lb

DATAPoint 3300-200 THERMAL PRINTER

SURPRISING LITTLE THERMAL PRINTER USES WELL RESPECTED AND FIELD PROVEN NCR EMT-1-AE PARALLEL PRINTER WITH ADDITIONAL CIRCUIT BOARDS TO PROVIDE SERIAL RS232 INTERFACE, PRINTS UP TO 30 CPS. 110 VAC PS. USES WIDELY AVAILABLE NCR PAPER, 96 CHAR. ASCII, 80 COL., CRT COMPATIBLE 5 x 7 DOT MATRIX, SOLID STATE WITH LESS THAN 25 MOVING PARTS.



\$475

+ \$25 SHIPPING U.S.

DATAPoint CASSETTE

3300-300 \$195 + \$25 SHIPPING U.S.

SMALL STYLIZED CASSETTE RECORDER SERVES AS ADJUNCT BETWEEN CRT TERMINAL AND CPU. ON LINE STORAGE, OFF LINE MESSAGE PREPARATION, 450,000 CHAR. PER CASSETTE, NO POWER SUPPLY, 1/0 UP TO 2400 BPS.



KLEINSCHMIDT 311 \$250

THIS 30 CHAR/SEC DRUM PRINTER SITS IN A SOUND-PROOF ENCLOSURE, 64 CHAR., PARALLEL INPUT, 80 CHAR/LINE. ORIGINAL PRICE \$2100 WITH ENCLOSURE



DIGITRONICS D507

PAPER TAPE TRANSMITTER BEAUTIFUL 5' ENCLOSED CABINET PROVIDES TREMENDOUS SUPPLY OF GOODIES INCLUDING DIGITRONICS 2500 PHOTOELECTRIC PAPER TAPE READER, HEAVY DUTY POWER SUPPLY, 3 MUFFIN FANS, POWER CONTROL PANEL, CIRCUIT BOARDS, RELAYS, CABLES. SOME HAVE PAPER TAPE HANDLERS, ALL ON CASTERS

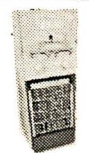

\$95 + SHIPPING 400 lb.

DATAPoint SERVO PRINTER IN DESK CONSOLE

\$395 + SHIPPING 285 lb.

IDEAL UNIT TO BUILD A SYSTEM AROUND. BOTH UNIVAC AND SINGER BUILT THESE PRINTER MECHANISMS WHICH OPERATE AT 30 CPS FROM A ROTATING WHEEL. 65 CHAR. USES STANDARD PRINTOUT OR TYPEWRITER PAPER. PINWHEEL IS INTERCHANGEABLE.

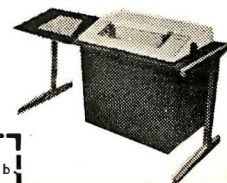

UNIVAC 0769-06 PRINTER MECHANISM ONLY...\$295
INCLUDES MOTOR/PRINT WHEEL + SHIPPING 75lb

1-DAY SHIPMENT KITS, MPUs, CPUs

(FROM OUR STOCK)

LSI...ADM 3 KIT.....\$875	KIM 1..6502.....\$245
UPPER/LOWER CASE OPTION 100	KIM 2..4k.....179
10 KEY NUMERIC PAD.....150	KIM 3..8k.....289
IMSAI..8080A KIT 5 SLOT..\$599	MANUALS PACKAGE.....15
8080A KIT 22 SLOT..651	ICOM FLOPPIES
4K MEMORY KIT.....139	FF36-1.....\$1195
VIKING 100 PIN CONNECTOR..	FF36-2.....1895
HEAVY DUTY.....\$5	360-58.....300
SERIAL I/O KIT.....125	\$171 H.....250
PROM 4-512 KIT.....165	TARBELL AUDIO
UCRI-1 KIT.....59	CASSETTE KIT.....\$120
CABLE A KIT.....18	INTERSL INTERCEPT JR.....\$281
SWTPC..6800 KIT.....\$399	12K RAM.....145
MPA.....145 MPB.....40	ROM/PROM BOARD.....74.65
MPC.....40 MPD.....35	YOU ADD MEM CHIPS
MPE.....15 MPF.....30	SERIAL I/O.....81.50
MPM.....80 MPN.....45	AUDIO VISUAL BOARD.....125
MPP.....35 MPL.....35	NATIONAL SEMICONDUCTOR
MPS.....35 MPAb..14.50	SC/MP KIT.....\$99
MPMb..14.50 MP8b..30	KEYBOARD KIT.....95
MPCb,MPsb,MPLb ea. 9.50	SHOKE 16 K MEMORY.....\$595
CONN. SETS MPU/MEM 2.50	
CONN. SETS INTERFC 2	shipping on kits
4KBA.....5 GT61...99	under \$100...\$5
AC30 AUDIO INTRFC 79.50	over \$100...\$10
PP40...PRINTER...250	WRITE FOR OUR COMPLETE
CT 1024 TERM. KIT..275	CATALOG
CT1.....175 KBD 49.95	covering kits, used equipment
CTP...15.50 CTS...39.95	and our wide range of
CTCA.....15.50	available books
ALL SWTPC UNITS ARE KITS	\$1.00

TO ORDER:

1. ENCLOSE CHECK FOR FULL PRICE PLUS SHIPPING CHARGES (IN MASS, ADD 5% SALES TAX)
 2. CLEARLY IDENTIFY SHIPPING ADDRESS.
 3. DESCRIBE ITEM BY MODEL #
- 1 DAY SHIPMENT IF BANK CHECK OR MONEY ORDER



VISIT OUR STORE: 9 TO 9 WEEKDAYS; 9 TO 6 SATURDAY

THE SC/MP AT \$95.00

SC/MP, the Microprocessor kit from National Semiconductor includes everything you need to build a completely functional microprocessor system — featuring the National SC/MP microprocessor — the low cost microprocessor for every application: Text Systems and Instrument Control; Machine Tool Control; Small Business Machines; Word Processing Systems; Educational Systems; Multiprocessor Systems; Process Controllers; Terminal Control; Laboratory Instrumentation; Sophisticated Games; Automotive Controller and Appliance Controllers.

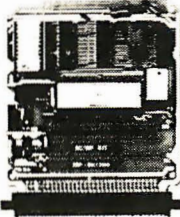

The kit, neatly packaged with all the components and literature you need, in a looseleaf binder, includes: The SC/MP Microprocessor — a single-chip Central Processing Unit in a 40-pin, dual in-line package. Features static operations, forty-six instruction types; single-byte and double-byte, software controlled interrupt structure, built in serial input/output ports; bidirectional 8-bit TRI-STATE^R bus, parallel data/port and latched 12-bit TRI-STATE^R address port. ROM — 512 bytes (8-bits/byte) of pre-programmed Read-Only-Memory containing KITBUG—a monitor and debugging program to assist in the development of your application programs, KITBUG provides teletypewriter input/output routines and allows examination, modification, and controlled execution of your programs. RAM-256 bytes of static read/write memory for storage of your application programs. Transfers of data to and from RAM are controlled by SC/MP and KITBUG. Teletypewriter Interface including buffer and drive capability for a 20 MA current loop interface. Voltage Regulator. Data Buffer—providing interface between memory and bidirectional data lines. All the literature you need, including schematics and programming manuals. Timing Crystal—providing 1.000 MHz timing signal. Plus all the passive components and circuit board with 72 pin edge connector required to build and interconnect your microprocessor system with external hardware.

SC/MP KEYBOARD KIT

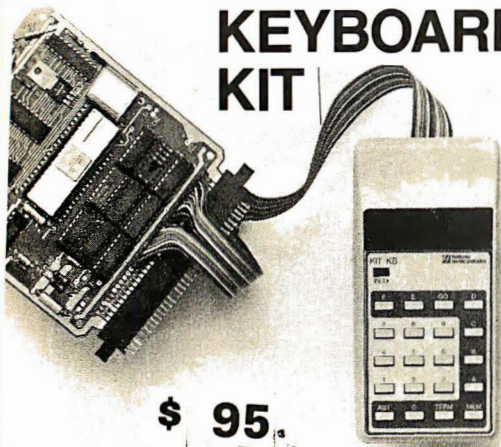

\$ 95.

This is a great kit for engineers and companies who don't have access to a Teletype. It is a low-cost teaching, learning, and developing tool for hobbyists, professors, students, and electronics entrepreneurs of all levels.

National's new Keyboard Kit now gives SC/MP Kit users a low-cost input/output capability. This new kit replaces the Teletype* normally required by the SC/MP Kit and allows users to evaluate the SC/MP CPU and to develop a variety of application software.

The heart of SC/MP Keyboard Kit is a ROM firmware package (512 bytes) called SCMPKB. The SCMPKB ROM replaces the "Kit Bug" ROM originally supplied with the SC/MP Kit and allows the effective use of the hexadecimal keyboard, to execute programs, to examine or modify the contents of memory and the SC/MP registers, and to monitor program performance.

ASC II KEYBOARD

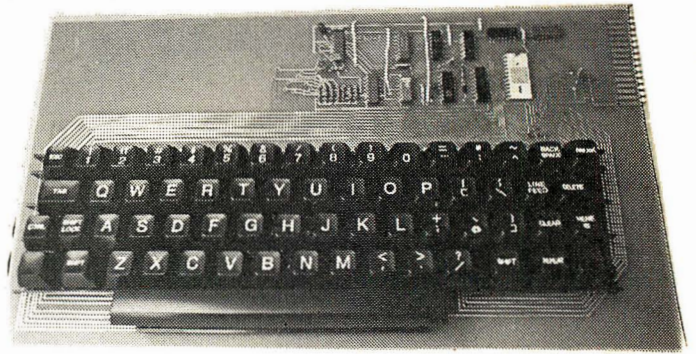

(Reg. \$58.85) **\$53.00**

This 63 key ASC II Encoded Keyboard kit was designed and manufactured by Electronics Warehouse Inc. Features: single 5 volt D.C. supply, utilizing only TTL logic elements (no MOS devices to blow), TTL drive capability (each of the eight bits of ASC II output will drive the equivalent of ten standard TTL inputs without external buffer drivers), de-bouncing, upper and lower case fully ASC II, 8 bit parallel output. In addition to the alpha-numeric and symbol keys available on a regular keyboard, the following keys are utilized: escape, back-space, tab, line-feed, delete, control, shift-lock, shift-(2 keys), here-is, control-release.

Kit includes: 63 key keyboard, P.C. board, all required components and assembly manual with ASC II code list.

Optional: 1. Parity bit - add \$1.00 Aluminum enclosure **\$39.-**
2. Serial output - add \$2.00

Note: If you already have this teletype keyboard you can have the kit without it for **\$36.00 (reg. \$39.85)**. Dealer inquires invited.

There is a hole pattern for additional integrated circuits on the SC/MP Kit PC card. By following the simple instructions in the SC/MP Keyboard Kit users manual, one can add buffers, decoders, drivers, multiplexers, etc. Simply replace the Kit Bug ROM (supplied in the SC/MP Kit) with the new SCMPKB ROM, connect the pre-assembled Keyboard cable connector to the kit card, and you are ready to go!

National's Keyboard Kit comes complete with manual, all required integrated circuits, resistors, keyboard display cable connector assembly, wire wrap connectors, precut wires—even a hand-held wire wrap tool.

SWITCHES

10 Position rotary switch
by oak manuf. \$1.00 per 4



8 position, 1 off switch in TO5 can

\$.69 2 for \$1.00

ROCKER SWITCH

SPST normally open contact rating 6A 250VAC
solder \$.50 ea \$2.00 per 6



MINIATURE TOGGLE SWITCH
SPST P.C. MOUNT **\$.99**



MINIMUM ORDER \$5.00

Shipping & Handling:

KEYBOARD or SC/MP - \$3.00 + \$.50 Insurance
all others - \$1.00

California residents add 6% sales tax.

ELECTRONICS WAREHOUSE Inc.

1603 AVIATION BLVD.
REDONDO BEACH, CA. 90278
TEL. (213) 376-8005

WRITE FOR FREE CATALOG

You are invited to visit our store at the above address

World's Lowest IC Prices

* SPECIAL PRICES *

MEMORIES						
<u>Rams</u>						
2102	1.50*	74152	.90	HIGH SPEED	4007	.16
<u>Proms</u>		74155	.60	74H00	4008	.70
82S23/S123	1.95*	74157	.60	74H01	4011	.16*
TTL		74160	.75	74H04	4012	.16*
7400	.12*	74161	.75*	74H10	4013	.30*
7402	.14			74H11	4015	.80
7403	.14*	74163	.75*	74H40	4016	.35*
7404	.16*	74165	.80	74H51	4019	.70
7407	.20	74173	1.25	74H52	4020	.90
7410	.12*	74174	.75	74H74	4021	.95
7420	.12*	74175	.75*	74H103	4023	.16*
7427	.25	74177	.70	74H106	4024	.75
		74180	.80		4025	.20*
		74181	1.50	LOW POWER	4027	.40
				SCHOTTKY	4028	.60
				74LS00	4030	.35
		74192	.70*	74LS02	4040	.95
		74193	.70*	74LS08	4042	.60
7438	.20*	74194	.85	74LS10	4043	.75
7440	.12*	74198	1.25	74LS27	4044	.70
7441	.65*	9602	.50*	74LS73	4049	.35*
		9300	.75	74LS75	4050	.35*
7445	.45	9312	.70	74LS151	4066	.65
7447	.75			74LS153	4068	.35
7450	.14	SCHOTTKY		74LS157	4069	.16
7451	.14*	74S01	.25	74LS161	4071	.16
7473	.22	74S02	.25	74LS163	4073	.16
7474	.23	74S37	.40	74LS164	4075	.16
		74S38	.60	74LS174	4516	.85
7480	.40*	74S85	2.00	74LS175	4528	.75
		74S113	.80	74LS193	4585	.85
7493	.50	74S139	1.50	74LS221	LINEARS	
7495	.49	74S140	.50	74LS251	NE536T	2.75
74107	.29	74S153	2.50	74LS253	NE555V	.43
74109	.30	74S172	4.50	74LS257	NE556A	.90
74116	1.50	74S174	2.05	74LS258	1456V	.75
74123	.45*	74S175	2.05*	CMOS	1458V	.52
74141	.80*	74S181	4.50	4001	566V	1.25
74145	.75	74S197	2.20	4002	567V	1.35
74150	.60*	74S257	1.50	4006	540L	2.00
74151	.60					

Order Minimum \$10.00. Add \$1.00 shipping and handling charge per order. California residents add 6% sales tax. All orders shipped First Class within 24 hours.

Order the famous Iasis 6 volume Programmed Learning Course "Microcomputer Design is a Snap" for \$99.50 and receive a special \$10.00 credit on any group of IC's.

Satisfaction 100% guaranteed.

C.O.D. Orders: Phone (day or night) 408/354-1448

ELTRON

PO BOX 2542B
Sunnyvale, CA 94087

Free monthly catalog—Just send us your name and address

For more information circle 102.

from Parts to Peripherals...



YOUR ONE STOP, MAIL-ORDER COMPUTER STORE.

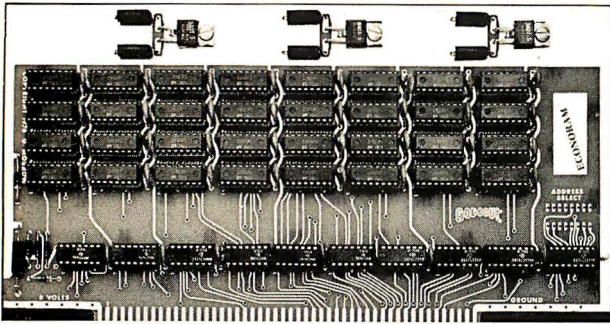

ECONOROM™

\$99.95

OVER TWO YEARS OF EXPERIENCE SELLING 4K X 8 BOARDS HAS SHOWN US EXACTLY WHAT YOU WANT IN A MEMORY BOARD KIT.

- YOU WANT LOW POWER TO STRETCH YOUR POWER SUPPLY. ANY COMPANY CAN CLAIM LOW POWER; NOT EVERY COMPANY OFFERS A SPEC TO BACK IT UP. WE GUARANTEE CURRENT CONSUMPTION UNDER 750 MA, WITH THE AVERAGE BOARD FALLING BETWEEN 600 AND 650 MA.
- YOU WANT S-100 BUSS COMPATIBILITY...AND ECONOROM IS FULLY COMPATIBLE.
- YOU WANT CLEAN AND UNAMBIGUOUS DATA TRANSFER...WHICH IS WHY WE BUFFERED OUR ADDRESSES, DATA LINES, AND OUTPUTS LONG BEFORE THE OTHER GUYS CAUGHT ON.
- YOU WANT A FAST BOARD. BY USING MEMORIES GUARANTEED AT 450 NS WORST CASE OVER THE FULL TEMP RANGE, WE CAN GUARANTEE THIS BOARD TO RUN AT ZERO WAIT STATES (500 NS OR BETTER). A 450 NS MEMORY ALSO ALLOWS FOR ANY PROPAGATION DELAYS IN SUPPORT CIRCUITRY.
- YOU WANT QUALITY, AND WE DELIVER IT: FROM THE EPOXY GLASS, DOUBLE SIDED, PLATE THROUGH BOARD...TO THE LOW PROFILE SOCKETS...THE OPTIMIZED THERMAL DESIGN...THE DIPSWITCH ADDRESS SELECTOR...THE LOW POWER SCHOTTKY SUPPORT ICs...THE GUARANTEE WE OFFER ON ALL PARTS USED IN ECONOROM...AND MORE.
- YOU WANT LOW COST. BECAUSE OF OUR PURCHASING POLICIES AND QUANTITY BUYING, WE CAN STILL DELIVER A BOARD OF THIS QUALITY FOR UNDER \$100. YOU CAN PAY LESS, AND YOU CAN GET LESS. BUT IF YOU WANT THE BEST COMBINATION OF VALUE AND ECONOMY...ECONOROM GIVES YOU BOTH.

ALSO AVAILABLE ASSEMBLED, TESTED, AND WARRANTED FOR ONE YEAR FOR \$129.95. DISCOUNTS ON ALL KITS AVAILABLE FOR GROUP PURCHASES.

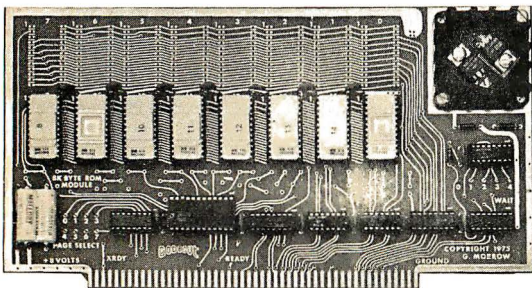

ECONOROM™

GIVE YOUR CPU A FRIEND: A HOME FOR PROGRAMS AND ROUTINES!

OUR BASIC ECONOROM BOARD IS 4K X 8 WORTH OF ERASEABLE ROM, WHICH YOU CAN PROGRAM WITH ANY PROGRAM OR ROUTINE YOU WANT (OR HAVE US PROGRAM IT FOR YOU). SIMILAR FEATURES AND SAME QUALITY AS OUR ECONOROM--AND ALSO VERY LOW POWER: 5V @ 1/2A, -12V @ 150 MA. WE OFFER SEVERAL OPTIONS:

- BASIC ECONOROM BOARD (4K X 8).....\$179.95
- SMALLER ECONOROM BOARD (2K X 8).....\$135.00
- BIGGER ECONOROM BOARD (8K X 8; HOLDS 8K BASIC).....\$269.95
- 8080 SOFTWARE BOARD (THIS IS OUR 4K BOARD, PROGRAMMED WITH EDITOR, ASSEMBLER, AND MONITOR ROUTINES FOR THE 8080...A VALUABLE FIRST STEP IF YOU'RE TRYING TO GET AWAY FROM MACHINE LANGUAGE PROGRAMMING. INFO PACKAGE AVAILABLE THAT DESCRIBES THE FUNCTION OF ALL SOFTWARE FOR \$2.95 (REFUNDABLE WITH ORDER).....\$189.95

Low Power Schottky

74LS00	\$0.36
74LS01	0.36
74LS02	0.36
74LS04	0.42
74LS08	0.38
74LS10	0.36
74LS11	0.38
74LS14	1.38
74LS20	0.36
74LS21	0.38
74LS22	0.38
74LS27	0.38
74LS30	0.36
74LS32	0.38
74LS37	0.53
74LS38	0.53
74LS42	1.25
74LS74	0.56
74LS75	0.85
74LS109	0.60
74LS124	2.50
74LS125	0.75
74LS126	0.75
74LS132	1.50
74LS138	1.38
74LS139	1.38
74LS155	1.38
74LS157	1.25
74LS160	1.85
74LS161	1.85
74LS162	1.85
74LS163	1.85
74LS168	1.87
74LS169	1.87
74LS174	1.38
74LS175	1.35
74LS221	1.38
74LS240	1.88
74LS257	1.25
74LS258	1.38
74LS273	2.25
74LS283	1.20
74LS367	1.00
74LS368	1.00
74LS377	1.88
74LS378	1.38
81LS95	1.13
81LS96	1.13
81LS97	1.13
81LS98	1.13

We Now Distribute Knowledge!

We are happy to carry the Adam Osborne & Associates series of books on microcomputers, as lucid and complete a treatment of the subject as we've seen to date. All books postpaid in the USA; set of all three books available for only \$25.00.

- VOL 1 "An Introduction to Microcomputers"** Order book #2001. Gives the basics of uP based systems.....\$7.00
- VOL 2** This recent addition gives up-to-date information on microprocessors---equivalent to hundreds of pages of data sheets. Order book #3001.....\$12.50
- VOL 3 "8080 Programming for Logic Design"** #4001 \$7.50

LOOKING FOR A GOOD CONNECTION?

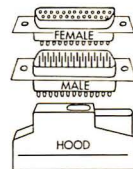

25 PIN RS-232 CONNECTORS: sub-mini D type.

Male plug with plastic hood, part #DB25P\$3.95

Female jack, part #DB25S\$3.95

309K.....+5V, 1A...	\$1.25
320/12T...-12V, 3A...	1.25
340/5K...+5V, 1A...	1.25
340/5T...+5V, 1A...	1.75
340/6T...+6V, 1A...	1.75
340/8K...+8V, 1A...	1.75
340/8T...+8V, 1A...	1.75
340/12T...+12V, 1A...	1.75
340/15K...+15V, 1A...	1.85
340/15T...+15V, 1A...	1.75
340/18K...+18V, 1A...	1.75
340/24K...+24V, 1A...	1.75
340/24T...+24V, 1A...	1.75

REGULATORS

Now you have a choice--specify wire wrap pins (illustrated) or solder-tail with .250" row spacing. For IMSAI and Altair peripherals.

Wire wrap part # S-100NW. Solder-tail part # S-100ST.

#S-100ST is ideal for the IMSAI motherboard.

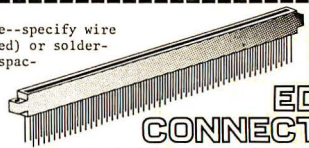

100 PIN EDGE CONNECTOR

\$5 EACH--\$22 FOR 5

LOW PROFILE sockets WIRE WRAP

Soldertail, tin plated	3 level, gold plated
14 pin.....10/\$1.95	14 pin.....10/\$3.70
16 pin.....10/\$2.15	16 pin.....10/\$3.85
18 pin.....10/\$2.75	18 pin.....10/\$0.75
20 pin.....10/\$3.10	22 pin.....10/\$1.50
22 pin.....10/\$3.50	24 pin.....10/\$1.00
24 pin.....10/\$3.60	28 pin.....10/\$1.25
36 pin.....10/\$5.50	36 pin.....10/\$1.35
40 pin.....10/\$6.15	40 pin.....10/\$1.75

CRYSTALS

WE OFFER TWO DIFFERENT TYPES OF CRYSTALS---

STATEK XTALS: .01% accuracy in a T0-5 can. Excellent for fixed frequency applications, or use with binary dividers to generate more frequencies. Choose from (in KHz): 10,000, 12,800, 15,360, 16,000, 16,384, 18,641, 19,200, 20,480, 30,720, 31,500, 32,768, 38,400, 40,960, 60,000, 76,800, 100,000, 153,600, and 240,000.

SENTRY XTALS: Series mode, fundamental, wire leads. Choose from 4, 5, 8, 9, 10, 12, 15, 18, and 20 MHz. (Note: 18 MHz = 8080 clock, 4 MHz = PACE clock freq.)

AN OFFER YOU CAN'T REFUSE!

2102-1Is.....10/\$15!

Not retests...full spec (450 ns full temp range), ultra-low power prime units. We mean it when we say you get the best for less...find out for yourself. Orders must be postmarked before 3/31/77

The tip of the iceberg:

This page is just a sampling of what you'll find in our latest flyer...we also carry Vector products, like their 8800V prototyping board, their beautiful new Vector-Pak enclosures, and helpful tools like the Slit-N-Wrap and Wiring Pencil...not to mention Vectorboard and all their useful little terminals. Then there are our chip sets...other kits...power supplies...components...the latest TTL...CMOS...if you want to get plugged into a great source of parts that delivers from stock, send for our flyer.



TERMS

TERMS: No COOs; Cal res add tax. Add 50c to orders under \$10; over \$10 add 5¢ handling/shipping. Call (415) 562-0636, 24 hrs, to place BankAmericard® or Mastercharge® credit card orders.

BILL GODBOUT ELECTRONICS
BOX 2355, OAKLAND AIRPORT, CA 94614

7400N TTL

SN7400N	16	SN7459A	25	SN74154N	1.00
SN7401N	21	SN7460N	22	SN74155N	1.00
SN7403N	16	SN7472N	39	SN74156N	99
SN7404N	18	SN7473N	37	SN74157N	99
SN7405N	24	SN7474N	32	SN74160N	1.25
SN7406N	20	SN7475N	50	SN74161N	99
SN7407N	29	SN7476N	39	SN74163N	99
SN7408N	25	SN7479N	5.00	SN74164N	1.10
SN7409N	25	SN7480N	5.00	SN74165N	1.10
SN7410N	30	SN7482N	98	SN74166N	1.25
SN7411N	30	SN74167N	7.00	SN74167N	2.10
SN7412N	33	SN7485N	89	SN74170N	2.10
SN7413N	45	SN7486N	39	SN74172N	8.50
SN7414N	40	SN7488N	3.50	SN74173N	1.95
SN7416N	35	SN7489N	2.49	SN74174N	1.25
SN7417N	35	SN7490N	45	SN74175N	1.95
SN7420N	21	SN7491N	7.50	SN74176N	9.00
SN7421N	33	SN7492N	49	SN74177N	9.00
SN7422N	49	SN7493N	49	SN74180N	99
SN7423N	37	SN7494N	7.50	SN74181N	2.49
SN7425N	29	SN7495N	7.50	SN74182N	95
SN7426N	29	SN7496N	89	SN74184N	1.95
SN7427N	37	SN7497N	4.00	SN74185N	2.20
SN7429N	42	SN7498N	1.00	SN74186N	15.00
SN7430N	27	SN7499N	3.30	SN74187N	6.00
SN7432N	31	SN74120N	39	SN74188N	3.15
SN7437N	26	SN74122N	39	SN74190N	1.19
SN7438N	27	SN74123N	50	SN74191N	1.25
SN7439N	25	SN74125N	60	SN74192N	89
SN7440N	15	SN74126N	50	SN74193N	99
SN7441N	89	SN74127N	1.09	SN74194N	1.25
SN7442N	59	SN74136N	95	SN74195N	7.50
SN7443N	75	SN74141N	1.15	SN74196N	1.25
SN7444N	75	SN74142N	4.00	SN74197N	7.50
SN7445N	75	SN74143N	7.50	SN74198N	1.75
SN7446N	81	SN74144N	4.50	SN74199N	1.75
SN7447N	69	SN74145N	1.15	SN74200N	5.95
SN7448N	79	SN74147N	2.35	SN74201N	9.00
SN7450N	26	SN74148N	2.00	SN74202N	1.79
SN7451N	27	SN74149N	2.00	SN74203N	1.79
SN7453N	27	SN74151N	7.90	SN74204N	6.00
SN7454N	20	SN74153N	89	SN74205N	7.50

FAIRCHILD TECHNOLOGY KITS FAIRCHILD

- Complete Specifications on back of each kit
- Packaged for WALL DISPLAY APPEARANCE
- Dealer's Inquires Invited — Price List Available

7205 - Stop Watch Chip \$19.95

DIGITS		PHOTO ARRAYS	
FKTK001	0.5" High Common Cathode Digit	FKTK040	9-Element Tape Reader Array
FKTK002	0.5" High Common Cathode Digit	FKTK041	12-Element Card Reader Array
FKTK003	357" High Common Cathode Digit	FKTK042	Reflective Opto Coupler
FKTK005	0.8" High Common Cathode Digit		
0.8" HIGH DISPLAY ARRAYS		COUPLERS	
FKTK010	12 Hour, 3 1/2 Digit Clock Display	FKTK050	3 General Purpose Opto Couplers
FKTK011	24 Hour, 4 Digit Clock Display	FKTK051	Darlington Opto Coupler
LED LAMPS		MOS CLOCK CIRCUITS	
FKTK020	10 Red LED Lamps	FKTK040	Digital Clock/Calendar Circuit (FCM7001)
FKTK022	10 Mixed Colored LED Lamps	FKTK041	Digital Clock/Calendar with BCD Outputs (FCM7002)
FKTK023	5 Three Piece LED Mounting Adapters	FKTK043	Direct Drive Digital Clock Circuit with AC Output (FCM3817A)
		FKTK045	Direct Drive Digital Clock Circuit with DC Output (FCM3817D)
PHOTO TRANSISTORS		KITS	
FKTK030	5 Flat Lens Photo Transistors	FKTK016	Automobile Clock Kit
FKTK032	3 Flat Lens Photo Darlington		
FKTK033	3 Round Lens Photo Darlington		

DISCRETE LEOS

125" dia.		185" dia.		200" dia.		280" dia.		90" dia.	
XC209	Red 10S1	XC22	Red 10S1	XC22	Red 10S1	XC22	Red 10S1	XC111	Red 10S1
XC209	Green 4S1	XC22	Green 4S1	XC22	Green 4S1	XC22	Green 4S1	XC111	Green 4S1
XC209	Orange 4S1	XC22	Orange 4S1	XC22	Orange 4S1	XC22	Orange 4S1	XC111	Orange 4S1

SPECIAL * — XC556 Red 100/\$8.00 1000/\$60.00 — SPECIAL *

DISPLAY LEOS

TYPE	POLARITY	HT	TYPE	POLARITY	HT
MAN 1	Common Anode	270 2.95	MAN 3620	Common Anode-orange	300 1.75
MAN 2	5 x 7 Dot Matrix	300 4.95	MAN 3640	Common Cathode-orange	300 1.75
MAN 3	Common Cathode	125 3.99	MAN 4710	Common Anode-Red	400 1.95
MAN 4	Common Cathode	187 1.95	DL701	Common Anode-Red	300 99
MAN 7	Common Anode	300 2.25	DL704	Common Cathode	300 99
MAN 7G	Common Anode-green	300 1.95	DL707	Common Anode	300 99
MAN 7Y	Common Anode-yellow	300 1.95	DL 728	Common Cathode	500 1.95
MAN 52	Common Anode-green	300 1.75	DL 747	Common Anode	600 2.25
MAN 64	Common Anode-Red	400 1.75	DL 750	Common Cathode	600 2.49
MAN 72	Common Anode	300 1.25	DL 788	Common Cathode	110 5.00
MAN 74	Common Cathode	300 1.50	FN707	Common Cathode	250 7.50
M&N 82	Common Anode-yellow	300 1.75	FN803	Common Cathode	500 1.00
MAN 84	Common Cathode-yellow	300 1.75	FN507	Common Anode	500 1.00

IC SOLDERTAIL — LOW PROFILE (TIN) SOCKETS

Pin	1-14	15-49	50-100	Pin	1-24	25-49	50-100
8 pin	5	17	19	24 pin	5	28	37
14 pin	20	19	20	24 pin	28	45	44
16 pin	22	21	20	36 pin	60	59	58
18 pin	29	28	27	40 pin	63	62	61
22 pin	37	36	35				

SOLDERTAIL STANDARD (TIN)

14 pin	5	27	25	24	28 pin	5	99	90	81
16 pin	30	27	25	25	36 pin	1	139	126	115
18 pin	35	32	30	40 pin	1	159	145	130	
24 pin	49	45	42						

SOLDERTAIL STANDARD (GOLD)

8 pin	5	30	27	24	24 pin	5	70	63	57
14 pin	35	32	29	28 pin	1	110	100	90	80
16 pin	38	35	32	36 pin	1	125	115	105	95
18 pin	52	47	43	40 pin	1	175	159	145	130

WIRE WRAP SOCKETS (GOLD) LEVEL #3

10 pin	5	45	41	37	24 pin	5	105	95	85
14 pin	39	38	37	37	28 pin	1	140	125	110
16 pin	43	42	41	41	36 pin	1	159	145	130
18 pin	75	65	62	40 pin	1	175	155	140	

Plastic Push Button Switch

* 18 AWG Solid Wire - 3/4" Long
* 50 (wide) X 60 (high) 3/27 Thread
* 8 AMP @ 14 Volt - 1 AMP @ 110 Volt

MINIATURE TOGGLE SWITCH

JMT-221	DPDT on/off/on	\$1.95
JMT-223	SPDT on/none/on	\$1.75
JMT-121	SPDT on/off/on	\$1.50
JMT-123	SPDT on/none/on	\$1.25

CLIPLITE NEW LED MOUNTING SYSTEM — to be used with XC56 LEOS — SPECIFY COLORS — 8/\$1.49

SPECIAL RED — GREEN — AMBER — YELLOW

50 PCS. RESISTOR ASSORTMENTS \$1.75 PER ASST.

ASST.	Resistor Values	Quantity
ASST. 1	10 OHM 12 OHM 15 OHM 18 OHM 22 OHM 27 OHM 33 OHM 39 OHM 47 OHM 56 OHM	1/4 WATT 5% — 50PCS.
ASST. 2	68 OHM 82 OHM 100 OHM 120 OHM 150 OHM 180 OHM 220 OHM 270 OHM 330 OHM 390 OHM	1/4 WATT 5% — 50 PCS.
ASST. 3	470 OHM 560 OHM 680 OHM 820 OHM 1K	1/4 WATT 5% — 50 PCS.
ASST. 4	3.3K 3.9K 4.7K 5.6K 6.8K 8.2K 10K 12K 15K 18K	1/4 WATT 5% — 50 PCS.
ASST. 5	22K 27K 33K 39K 47K 56K 68K 82K 100K 120K	1/4 WATT 5% — 50 PCS.
ASST. 6	150K 180K 220K 270K 330K 390K 470K 560K 680K 820K	1/4 WATT 5% — 50 PCS.
ASST. 7	1M 1.2M 1.5M 1.8M 2.2M 2.7M 3.3M 3.9M 4.7M 5.6M	1/4 WATT 5% — 50PCS.

ASST. 8R Includes Resistor Assortments 1-7 (350 PCS.) \$10.95 ea.

\$5.00 Minimum Order — U.S. Funds Only
California Residents — Add 6% Sales Tax
Spec Sheets - 25¢ — Send 24¢ Stamp for 1977 Catalog
Dealer Discount Available — Request Pricing

WIRE WRAP CENTER

HOBBY-WRAP TOOL-BW-630

- Battery Operated (Size C)
- Weights ONLY 11 Ounces
- Wraps 30 AWG Wire onto Standard DIP Sockets (0.25 inch)
- Complete with built-in bit and sleeve

\$34.95 (batteries not included)

WIRE-WRAP KIT — WK-2-W

WRAP • STRIP • UNWRAP

- Tool for 30 AWG Wire
- Roll of 500 ft. White 30 AWG Wire
- 50 pcs. each 1", 2", 3" & 4" lengths — pre-stripped wire, wire

\$11.95

WIRE WRAP TOOL WSU-30

WRAP • STRIP • UNWRAP — \$5.95

WIRE WRAP WIRE — 30 AWG

25 ft. min. \$1.25 50 ft. \$1.95 100 ft. \$2.95 1000 ft. \$15.00
SPECIFY COLOR — White - Yellow - Red - Green - Blue - Black

THUMBWHEEL SWITCHES

THUMBWHEEL SWITCH ONLY
Part No. Description Price
SF 12 12 Position 3.00
SF 12 12 Position BCD only 3.00
SF 21 12 Position 4.00
SF 21 12 Position BCD only 4.00

Ordering: Order desired switch or switches and add necessary accessories for your particular application

Series 21 Front Mount Assembly SF - Front Mount SR - Rear Mount

ACCESSORIES

Part No.	Description	Price	Part No.	Description	Price
SF EP	End Plate (each)	50	SR EP	End Plate (each)	50
SF DP	Divider Plate (each)	40	SR DP	Divider Plate (each)	40
SF RB	Blank Body (each)	40	SR RB	Blank Body (each)	40
SF HB	Hall Body (each)	40	SR HB	Hall Body (each)	40

Permacel Electrical Tape

* 3/4" wide X 6 ft (long) A1 weather • Not limited!
\$1.49 per roll — \$12.50 per 10 roll package

ZENERS — DIODES — RECTIFIERS

TYPE	VOLTS	V	PRICE	TYPE	VOLTS	V	PRICE
1N4745	3.3	400mm	4/100	1N4005	600 PIV 1 AMP	10	10.00
1N751A	5.1	400mm	4/100	1N4006	800 PIV 1 AMP	10	10.00
1N752	5.6	400mm	4/100	1N4007	1000 PIV 1 AMP	10	10.00
1N753	6.2	400mm	4/100	1N6300	50 200mm	6	6.00
1N754	6.8	400mm	4/100	1N4148	75 10mm	15	15.00
1N555	8.2	400mm	8/100	1N1154	35 10mm	12	12.00
1N659	15	400mm	4/100	1N4305	75 25mm	20	20.00
1N5232	5.6	500mm	28	1N4734	5.6 1w	28	28
1N5234	6.2	500mm	28	1N4735	6.2 1w	28	28
1N5235	6.8	500mm	28	1N4736	6.8 1w	28	28
1N5236	7.5	500mm	28	1N4738	8.2 1w	28	28
1N458	25	40mm	6/100	1N4742	12 1w	28	28
1N458	150	7mm	6/100	1N4743	15 1w	28	28
1N485A	180	10mm	6/100	1N1183	50 PIV 35AMP	1.60	1.60
1N4001	50 PIV 1 AMP	12/100	12/100	1N1183	100 PIV 35AMP	1.70	1.70
1N4002	400 PIV 1 AMP	12/100	12/100	1N1185	150 PIV 35 AMP	1.60	1.60
1N4003	200 PIV 1 AMP	12/100	12/100	1N1166	200 PIV 35 AMP	1.80	1.80
1N4004	400 PIV 1 AMP	12/100	12/100	1N1166	400 PIV 35 AMP	3.00	3.00

SCR AND FW BRIDGE RECTIFIERS

C36D	15A @ 400V	SCR	\$1.95
C36M	35A @ 200V	SCR	1.95
M2A328	1.6A @ 200V	SCR	1.95
MDA 800-1	12A @ 50V	FW BRIDGE REC.	1.95
MDA800-3	12A @ 20V	FW BRIDGE REC.	1.95

TRANSISTORS

MPS A05	\$5.00	PN1249	\$4.00
MPSA06	\$5.00	PN2430	\$4.00
2N2222A	\$5.00	PN3568	\$4.00
2N2222A	\$5.00	PN3569	\$4.00
2N2907	\$5.00	2N4001	\$5.00
2N2907A	\$5.00	2N4002	\$5.00
2N2907B	\$5.00	2N4003	\$5.00
2N424	\$5.00	2N4205	\$5.00
2N424	\$5.00	2N4206	\$5.00
2N424	\$5.00	2N4207	\$5.00
2N424	\$5.00	2N4208	\$5.00
2N424	\$5.00	2N4209	\$5.00
2N424	\$5.00	2N4210	\$5.00
2N424	\$5.00	2N4211	\$5.00
2N424	\$5.00	2N4212	\$5.00
2N424	\$5.00	2N4213	\$5.00
2N424	\$5.00	2N4214	\$5.00
2N424	\$5.00	2N4215	\$5.00
2N424	\$5.00	2N4216	\$5.00
2N424	\$5.00	2N4217	\$5.00
2N424	\$5.00	2N4218	\$5.00
2N424	\$5.00	2N4219	\$5.00
2N424	\$5.00	2N4220	\$5.00
2N424	\$5.00	2N4221	\$5.00
2N424	\$5.00	2N4222	\$5.00
2N424	\$5.00	2N4223	\$5.00
2N424	\$5.00	2N4224	\$5.00
2N424	\$5.00	2N4225	\$5.00
2N424	\$5.00	2N4226	\$5.00
2N424	\$5.00	2N4227	\$5.00
2N424	\$5.00	2N4228	\$5.00
2N424	\$5.00	2N4229	\$5.00
2N424	\$5.00	2N4230	\$5.00
2N424	\$5.00	2N4231	\$5.00
2N424	\$5.00	2N4232	\$5.00
2N424	\$5.00	2N4233	\$5.00
2N424	\$5.00	2N4234	\$5.00
2N424	\$5.00	2N4235	\$5.00
2N424	\$5.00	2N4236	\$5.00
2N424	\$5.00	2N4237	\$5.00
2N424	\$5.00	2N4238	\$5.00
2N424	\$5.00	2N4239	\$5.00
2N424	\$5.00	2N4240	\$5.00

CRYSTALS

THESE FREQUENCIES ONLY

Part #	Frequency	Case/Style	Price
CY1A	1.000 MHz	HC33/U	\$5.95
CY2A	2.000 MHz	HC33/U	\$5.95
CY3A	4.000 MHz	HC18/U	\$4.95
CY7A	5.000 MHz	HC18/U	\$4.95
CY12A	10.000 MHz	HC18/U	\$4.95
CY14A	14.31819 MHz	HC18/U	\$4.95
CY19A	18.000 MHz	HC18/U	\$4.95
CY22A	20.000 MHz	HC18/U	\$4.95
CY30B	32.000 MHz	HC18/U	\$4.95

XR-2260KB Kit	XR-2206KA Kit
\$27.95	\$17.95

EXAR

WAVEFORM GENERATORS

Model	Price
XR-205	\$8.40
XR-2206CP	4.49
XR-2207CP	3.85

MISCELLANEOUS

Model	Price
XR-2211CP	\$6.70
XR-2240CP	3.25
XR-2556CP	1.55
XR-2566CP	1.85
XR-2566CP	3.20
XR-2240CP	3.25

STEREO DECODERS

Model	Price
XR-1310CP	\$3.20
XR-1310EP	3.70
XR-1800P	3.70
XR-2567	2.90

PHASE LOCKED LOOPS

Model	Price
XR-4136	99
XR-1468	3.85
XR-1488	5.80
XR-210	5.20
XR-215	6.60
XR-367CP	1.95
XR-357CT	1.70

MICROPROCESSOR COMPONENTS

Part #	Description	Price
8080A	CPU	\$19.95
8212	8 Bit Input/Output	4.95
8216	Bi-Directional Bus Driver	6.95
8224	Clock Generator/Driver	10.95
8228	System Controller - Bus Driver	10.95

Part #	Description	Price
8008	8 BIT CPU	\$19.95
8080	Super 8008	24.95
8080A	Super 8008	19.95

Part #	Description	Price
2504	1024 Dynamic	\$ 3.95
2518	Hex 32 Bit	7.00
2519	Hex 40 Bit	7.00
2524	512 Dynamic	2.49
2525	1024 Dynamic	6.00
2527	Dual 256 Bit	3.95
2529	Dual 512 Bit	4.00
2532	Quad 256 Bit	3.95
2533	1024 Static	7.95
3341	Fifo	6.95
74LS570	16 x 4 Reg	3.95

Part #	Description	Price
AV-5-1013	30K Baud	\$5.95
2513	Char Gen	\$ 9.95
2516	Char Gen	10.95
74LS387	1024-Bit Programmable	1.95

Part #	Description	Price
1101	256 x 1 Static	\$ 2.25
1103	1024 x 1 Static	1.00
2101	256 x 4 Static	5.95
2102	1024 x 1 Static	1.75
2107	4096 x 1 Dynamic	9.95
2111	256 x 4 Static	6.95
2116	1024 x 1 Static	29.95
7040	1024 x 1 NMOS	2.49
7489	16 x 4 Static	2.49
8101	256 x 4 Static	6.95
8111	256 x 4 Static	6.95
8599	16 x 4 Static	3.99
9102	1024 x 1 Static	19.95
9320	256 x 1 Static	6.95
9341	256 x 1 Static	2.95
MM5262	2K x 4 Dynamic	.99

Part #	Description	Price
1702A	2048 Bit	\$12.95
5203	2048	14.95
82523	32 x 8	5.00
825123	32 x 8	5.00
74LS287	1024	1.95
3601	256 x 4	3.95

DIP SWITCH

These switches feature seven SPST slide switches in a molded dip. They are ideally suited for microprocessor applications.

\$1.95

Timeband

A trademark of Fairchild Camera and Instrument Corporation

DIGITAL ALARM CLOCK \$16.95

- 24-Hour Alarm
- "DOZE" Button
- 100% Solid State
- Large Red Led Display (.8" high)
- AM/PM Indicator
- Seconds Display at touch of button
- SPECIFY BLACK OR IVORY

DIGITAL WATCHES

Model	Price
Ladies Watch	\$59.95
EXELER Mens Watch	\$25.00

CONNECTORS

PRINTED CIRCUIT EDGE-CARD

156 Spacing-Tin-Double Read-Out
Bifurcated Contacts - Fits .054 to .070 P.C. Cards

Part #	Description	Price
15/30	PINS (Solder Eyelet)	\$1.95
18/36	PINS (Solder Eyelet)	\$2.49
22/44	PINS (Solder Eyelet)	\$2.95
50/100	(.100 Spacing) PINS (Solder Eyelet)	\$6.95

25 PIN-D SUBMINATURE

Part #	Description	Price
DB25	PLUG	\$3.25
DB25	SOCKET	\$4.95

IMC

3 1/2 DIGIT DVM KIT

This 0-2VDC .05 percent digital voltmeter features the Motorola 3 1/2 digit DVM chip set. It has a 4" LED display and operates from a single +5V power supply. The unit is provided complete with an injection molded black plastic case complete with bezel. An optional power supply is available which fits into the same case as the 0-2V DVM allowing 117 VAC operation.

A. 0-2V DVM with Case \$49.95
B. 5V Power Supply \$14.95

Special Programming Available - BI-POLAR FROM SPECIAL - Write or Call for Pricing

Part #	Description	Price
6330-1	256 Bit (32 x 8) Open Collector	2.95
6331-1	256 Bit (32 x 8) Three State	2.95
6330-1	1024 Bit (256 x 4) Open Collector	3.49
6331-1	1024 Bit (256 x 4) Three State	3.49
6330-1	2048 Bit (512 x 4) Open Collector	9.95
6331-1	2048 Bit (512 x 4) Three State	9.95
6340-1	2048 Bit (512 x 8) Open Collector	19.95
6341-1	2048 Bit (512 x 8) Three State	19.95
6352-1	4096 Bit (1024 x 4) Open Collector	19.95
6353-1	4096 Bit (1024 x 4) Three State	19.95

Continental Specialties

Proto Board 100 \$19.95

Here's a low cost, big 100 pin DIP board. It's the only board that fits all the variety of DIP packages and is the only board that fits all the variety of DIP packages. It's the only board that fits all the variety of DIP packages.

Proto Board 104 \$79.95

Here's a low cost, big 104 pin DIP board. It's the only board that fits all the variety of DIP packages and is the only board that fits all the variety of DIP packages.

Proto Board 103 \$39.95

Here's a low cost, big 103 pin DIP board. It's the only board that fits all the variety of DIP packages and is the only board that fits all the variety of DIP packages.

Proto Board 6 \$15.95

Here's a low cost, big 6 pin DIP board. It's the only board that fits all the variety of DIP packages and is the only board that fits all the variety of DIP packages.

5 FUNCTION ELECTRONIC CALCULATOR

RADOFIN MODEL 8P \$8.95

FEATURES:

- 6 Digit Display
- 5 Functions: Addition, subtraction, multiplication, division, percentage with constant on all functions, with full floating decimal point
- Power source: 6 piece 9V DC Battery 006P, pack for AC adapter
- Black superfine grained finish plastic cabinet

DIGITAL STOPWATCH

Bright 6 Digit LED Display
Times 10.9 minutes 59.99 seconds
Crystal Controlled Time Base
Three Stopwatches in One
Times Single Event - Split & Taylor
Size 4.5" x 2.15" x .90" (14% ounces)
Uses 3 Pennell Cells

Kit - \$39.95
Assembled - \$49.95
Heavy Duty Carry Case \$5.95

VECTOR WIRING PENCIL

Vector Wiring Pencil P173 consists of a handheld leather-wrapped (various one ounce) tool which is used to guide and wrap insulated wire. For use on standard replaceable bobbin, onto component leads or terminals installed on pre-punched "P" Pattern Vectorboard. Connections between the wrapped wire and pre-punched leads onto terminals are made by soldering. Complete with 250 FT of red wire.

\$9.95

REPLACEMENT WIRE - BOBBINS FOR WIRING PENCIL

Part #	Description	Price
W36-3-A-Pkg 3	250 Ft. 36 AWG GREEN	\$2.40
W36-3-B-Pkg 3	250 Ft. 36 AWG RED	\$2.40
W36-3-C-Pkg 3	250 Ft. 36 AWG CLEAR	\$2.40
W36-3-D-Pkg 3	250 Ft. 36 AWG BLUE	\$2.40

1/16 VECTOR BOARD

Material	Part No.	L	W	P	Price
PHENOLIC	64P-11 052XXXP	4.50	6.50	1.72	1.54
	169P-11 02XXXP	4.50	17.00	3.69	3.32
EPOXY	64P-11 062	4.50	6.50	2.07	1.86
	8P-11 062	4.50	6.50	2.56	2.31
GLASS	169P-11 062	4.50	17.00	5.04	4.53
	169P-11 062	4.50	17.00	9.23	8.26
EPOXY GLASS COPPER CLAD	169P-11 062C1	4.50	17.00	6.80	6.12

GEMINI-68 The Unique Microprocessing System

MIKBUG ROM
6810 RAM
6820 PIA
6800P CPU
1MHz Crystal
500ns Cycle-Stealing DMA
Low-Power RAMs
8K RAM Board
8K EPROM Board

STAND ALONE CPU BOARD - Has 384 bytes of RAM on board, serial I/O (RS-232 and 20 ma current loop, cycle stealing direct memory access (DMA), built in software - selectable echo-back capability. Part # SA-CPU Board **\$279.95**

CPU BOARD - Same as above but only has 128 bytes of RAM on board-used with 8K RAM board listed below. Part # Gemini 68 CPU Board **\$259.95**

8K RAM BOARD - Uses low power static RAMs, 500ns cycle time, 1.5 Amps Max. Part # Gemini 68 RAM Board **\$269.95**

8K EPROM BOARD - Uses 5204 EPROMs by AMI or NATIONAL. Shipped with all decode and miscellaneous IC's, except the 5204 EPROMs. Part # Gemini 68 EPROM Board **\$ 89.95**

NOT A KIT - ALL BOARDS ARE COMPLETELY ASSEMBLED, BURNED-IN AND TESTED. COMES WITH COMPLETE DOCUMENTATION.

Allow approximately 4 weeks for delivery

\$5.00 Minimum Order - U.S. Funds Only
California Residents - Add 6% Sales Tax
Spec Sheets - 25c - Send 24c Stamp for 1977 Catalog
Dealer Discount Available - Request Pricing

DIGITAL QUARTZ CAR CLOCK

Complete kit from mounting bracket of the injection molded case down to the three conductive power cord and all components including MM5314 clock chip. Features Quartz accuracy of 0.1%, six digit, 3 1/2" high LED display, and P.C. Boards. Works on any 12 volt system - motorcycles, boats, vans, motorhomes autos and trucks.

Kit: \$29.95
Assembled: \$39.95

CASE ONLY (includes hardware, mounting bracket and bezel) \$5.95

JE700 CLOCK

The JE700 is a low cost digital clock, but is a very high quality unit. The unit features a simulated walnut case with dimensions of 6" x 2 1/2" x 1". It utilizes a MAN72 high brightness readout, and the MM5314 clock chip.

\$17.95

JE500 KIT - ALL COMPONENTS & CASE \$34.95

WIRED & ASSEMBLED \$39.95

HEAT SINKS

Part #	Description	Price
205-CB	Beryllium Copper Heat Sink with Black Finish for TO-5	\$ 25
291-36H	Aluminum Heat Sink for TO-220 Transistors & Regulators	\$ 25
680-75A	Black Anodized Aluminum	\$1.60

HEXADECIMAL ENCODER 1 9-KEY PAD

1 - 0
A B C D E F
Return Key
Optional Key (Period)
Key

\$10.95 each

63 KEY KEYBOARD

This keyboard features 63 unenclosed SPST keys, unattached to any kind of P.C.B. A very solid molded plastic 13" x 4" base suits most applications.

\$19.95

HDD165 16 LINE TO FOUR BIT PARALLEL KEYBOARD ENCODER **\$7.95**

JOYSTICK

These joysticks feature four potentiometers, that vary resistance proportional to the angle of the stick. Sturdy metal construction with plastic components only at the movable joint. Perfect for electronic games and instrumentation.

***5K Pots \$6.95**
***100K Pots \$7.95**

James ELECTRONICS

1021-A HOWARD AVE., SAN CARLOS, CA. 94070
PHONE ORDERS WELCOME - (415) 592-8097
All Advertised Prices Good Thru March

NOW OPEN SATURDAYS

DIGITAL CLOCK KIT - 3 1/2 INCH DIGITS

4 DIGIT KIT \$49.95
6 DIGIT KIT \$69.95

4 DIGIT ASSEMBLED \$59.95
6 DIGIT ASSEMBLED \$79.95

This clock features big 3 1/2" high digits for viewing in offices, auditoriums, etc. Each digit is formed by 31 bright 0.2" LED's. The clock operates from 117 VAC, has either 12 or 24 hr. operation. The 6 digit version is 27" x 3 1/2" x 1 1/2", and the 4 digit is 18" x 3 1/2" x 1 1/2". Kits come complete with all components, case and transformer.

Specify 12 or 24 Hour When Ordering

JE803 PROBE

The Logic Probe is a unit which is for the most part indispensable in trouble shooting logic families TTL DTL CMOS. It derives the power it needs to operate directly off of the circuit under test, drawing a scant 10 mA max. It uses a MAN3 readout to indicate any of the following states by these symbols: (H) - 1 (LOW) - 0 (PULSE) - P. The Probe can detect high frequency pulses to 45 MHz. It can't be used at MOS levels or circuit damage will result.

\$9.95 Per Kit
printed circuit board

T-PL 5V 1A Supply

This is a standard T-PL power supply using the well known LM309K regulator IC to provide a solid 1 AMP current at 5 volts. We try to make things easy for you by providing everything you need in one package, including the hardware for any.

\$9.95 Per Kit

SPECTRA FLAT TWIST

50 conductor, 28 gauge, 7 strands/conductor made by Spectra. Two conductors are paired & twisted and the flat ribbon made up of 25 pairs to give total of 50 conductors. May be peeled off in pairs if desired. Made twisted to cut down on "cross talk." Ideal for sandwiching PC boards allowing flexibility and working on both sides of the boards. Cost originally \$12.00/ft.

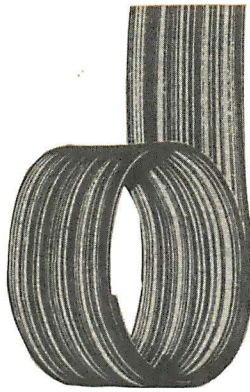

SP-234-A \$1.00 ft 50 cond. 10 ft/\$9.00
 SP-234-B .90 ft 32 cond. 10 ft/\$8.00

WIRE WRAP WIRE

TEFZEL blue #30 Reg. price \$13.28/100 ft. Our price 100 ft. \$2.00; 500 ft. \$7.50.

MULTI COLORED SPECTRA WIRE

Footage		10'	50'	100'
8 Cond.	#24	\$2.50	9.00	15.00
12 "	22	3.00	11.00	18.00
14 "	22	3.50	13.00	21.00
29 "	22	7.50	28.00	45.00

Great savings as these are about 1/4 book prices. All fresh & new.

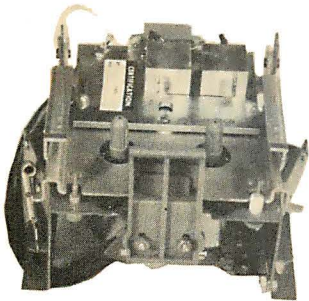

VIASTRON cassette tape deck as shown \$35.00
 Set of 2 read/write, amplifiers & servo control boards for deck \$40.00
 VIASTRON full spare set of 11 microprocessor boards, checked out \$200.00
 COM ADAPTER kit RS-232C will run any baud rate 110-1200 BPS. TTL logic and UART w/diagram, control panel for Viatron & cable \$90.00
 COM ADAPTER as above fully assembled & tested, panel, cables \$150.00
 VIASTRON large tape deck, 7 bit ascii, 9 track, 800 BPI w/power supply cables, control panel, tape, instructions \$375.00

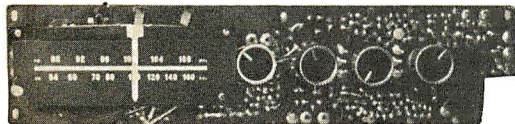

AM-FM solid state w/power supply for 115 volts AC. Has mike input, stereo tape or record player input, built-in loop stick. Ready to use, just add speakers \$10.00



CREDIT VALIDATOR

Made for feeding into a computer terminal to query the credit balance of a customer with push-button entry and audio response. Power supply in separate case attached to base may be removed to use for other projects should you wish to scrap. Regular 115 volt input and output of plus 5 volts and plus & minus 12 V both DC & regulated. The phone is touch pad style, automatic electric pad. All sold "as is" 2 PC boards inside jammed with various parts & ICs including memory. Uses buffers ICs to accelerate & decelerate call traffic. Inquiry from Validier emerge as short bursts of Binary data signals. Normally used over leased phone lines at 200 times the capacity of messages. All appear to be excellent & complete. A Computer gadgeteers SPECTACULAR. And at a crazy price of only \$18.00. 2 for \$35.00
 Ship. wgt. 10 lb. #SP-153-AL ea \$18.00

PARITY DETECTOR

New packaged, made for RCA, detects even or odd parity, baud rate 110, 150 or 134.46. Built-in logic supply for the ICs, operates from standard 115 Vac. Control panel allows manual or automatic reset mode of operation. Aluminum enclosure (not shown) covers the electronics. TTY compatible. Ship wt 10 lbs.\$12.50

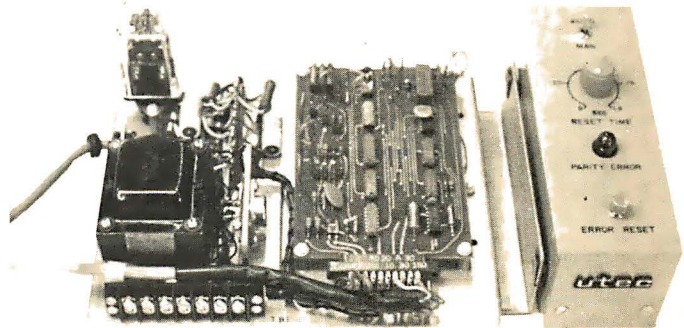

Meshna

Please add shipping cost on above.
 FREE CATALOG SP-9 NOW READY
 P.O. Box 62, E. Lynn, Massachusetts 01904

The prokoboard
from BIM...

\$14
2/\$25

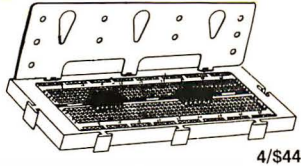

4/\$44

TOP QUALITY \$28

HEAVY
DUTY
POWER
TRANSFORMER
FOR
IMSAI/ALTAIR

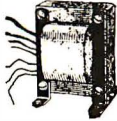

5VDC
@ 22A

#18 VDC
40V
(Prom programming)

INCLUDE APPROX SHIPPING

the proko
electronics shoppe

439marsh st.
san luis obispo, ca. 93401
805/544-5441

Check or money order
only. Calif. residents 6%
tax. All orders postpaid
in the U.S. \$10 Min.
order. Prices subject to
change without notice.

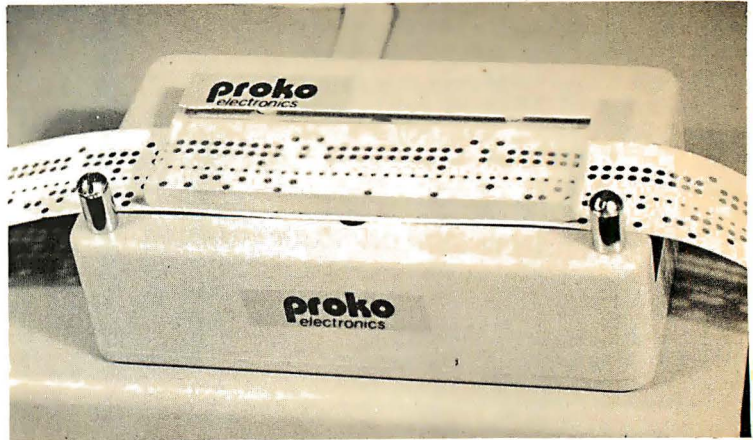

The Proko Paper Tape Reader: A manually operated reader, reads 9-level paper tape into any parallel input port. Just supply a light source, grab the tape and pull!

KIT \$42 Assem. \$55

KITS BY CYBERCOM A DIVISION OF SOLID STATE MUSIC

EDGE CONNECTORS

80 Pin WW .125" used \$1.50 ea. 10/12.50
86 Pin Solder tail .156" \$3.75 ea. 10/\$32
100 Pin spec WW or Solder tail both fit IMSAI or SSM
Mother Bd \$5.00 ea 10/\$44

82S06	2.00	82S126	3.50	74C200	5.50
82S07	2.00	82S129	3.50	8573	4.50
82S11	2.00	82S130	3.95	8574	5.50
82S12	2.00	82S131	3.95	8575	4.50
82S17	2.00	74S206	2.10	8576	4.50
82S23	2.50	74S412	4.00	8577	3.50
82S123	3.00	74S301	3.50	8578	4.00

7400	.16	7473	.35	74164	1.10
7401	.16	7474	.35	74165	1.10
7402	.21	7475	.50	74166	1.25
7403	.16	7476	.30	74170	2.10
7404	.18	7480	.50	74173	1.50
7405	.24	7483	.70	74174	1.95
7406	.20	7485	.90	74175	.95
7407	.29	7486	.40	74176	.90
7408	.25	7489	2.00	74177	.90
7409	.25	7490	.45	74179	.90
7410	.18	7491	.75	74180	.95
7411	.30	7492	.50	74181	2.50
7413	.45	7493	.50	74182	.95
7414	.70	7494	.80	74184	1.95
7416	.35	7495	.75	74185	2.20
7417	.35	7496	.90	74190	1.15
7420	.20	74100	1.00	74191	1.25
7423	.37	74107	.40	74192	.90
7425	.30	74109	.90	74193	.90
7426	.30	74121	.40	74194	1.25
7427	.35	74122	.50	74195	.75
7430	.25	74123	.70	74196	1.25
7432	.30	74125	.60	74197	.90
7437	.27	74126	.60	74198	1.75
7438	.27	74132	1.00	74199	1.75
7440	.15	74141	1.15	74200	4.95
7441	.85	74145	1.15	74251	1.75
7442	.60	74147	2.35	74284	4.95
7443	.75	74148	2.00	74285	4.95
7444	.75	74150	1.00	74365	.90
7445	.75	74151	.80	74367	.75
7446	.80	74153	.90	74368	.90
7447	.70	74154	1.00	MH0025	2.50
7448	.80	74155	1.00	MH0026	2.95
7450	.25	74156	1.00	95H90	9.95
7451	.25	74157	1.00	2102-1	1.65
7453	.25	74160	1.25	32	50.00
7454	.20	74161	1.00	64	96.00
7460	.20	74162	1.50	1488	1.50
7470	.45	74163	1.00	1489	1.50
7472	.40				

90 Day Guarantee on SSM Products. Kits MB-2, MB-3 (2K OR 4K), MB-4, MB-6, 10-2 video board and mother board with connectors may be combined for a discount of 10% in quantities of 10 or more. This supercedes the flier of 13 Sept. 1976.

4Kx8 Static Memories
MB-1 MK-8 board, 1 usec 2102 or eq. PC Board..... \$22
Kit.....\$83
MB-2 Altair 8800 or IMSAI compatible Switched address and wait cycles. PC Board.....\$25
Kit (91L02A .5 usec).... \$129.95

MB-4 Improved MB-2 designed for 8K "piggy-back" without cutting traces. PC Board \$30
Kit 4K .5 usec.....\$129.95 Kit 8K .5 usec.....\$199

MB-3 1702A's Eroms, Altair 8800 & Imsai 8080 compatible Switched address & wait cycles. 2K may be expanded to 4K. Kit less Proms.....\$65 2K Kit.....\$145
4K Kit.....\$225

MB-6A 8Kx8 Switched address and wait assignments
Memory protection is switchable for 256, 512, 1K, 2K, 4K and 8K. 91L02A .5 usec rams, Altair 8800 & IMSAI compatible. With battery power option
Kit.....\$250 Assembled & tested.....\$290

I/O Boards
I/O-2 I/O for 8800, 2 ports, committed pads for 3 more, other pads for EROMS UART, etc.
Kit.....\$47.50 PC Board only.....\$25

MM1402A	1.90	2501B	\$1.25	1101	1.25	74LS00	.40	74L00	.25	74L78	.90
MM1404A	1.90	2503V	2.00	1103	1.25	74LS01	.50	74L01	.25	74L85	1.40
MMS006A	1.50	2504V	2.00	2101	4.50	74LS02	.40	74L02	.25	74L86	.75
MMS013	2.50	2505K	2.00	2102-1	1.65	74LS03	.40	74L03	.25	74L89	3.50
MMS015A	1.50	2507V	1.25	2111-1	4.50	74LS04	.45	74L04	.30	74L90	1.50
MM5016	1.50	2509A	2.00	2112	4.50	74LS05	.45	74L05	.40	74L91	1.50
MM5017	1.90	2510A	2.00	2602	1.60	74LS10	.40	74L06	.30	74L93	1.70
MM5025	2.50	2511A	2.80	4002-1	7.50	74LS11	.50	74L08	.40	74L95	1.70
MM5026	2.50	2517V	1.25	4002-2	7.50	74LS12	.55	74L09	.40	74L98	2.80
MM5027	2.80	2518B	1.50	MM5260	1.00	74LS20	.40	74L10	.30	74L123	1.50
MM5053	1.50	2519B	2.80	MM5261	1.00	74LS22	.45	74L20	.35	74L154	2.00
MM5054	1.90	2521V	1.50	MM5262	1.00	74LS27	.45	74L26	.40	74L164	2.50
MM5055	1.90	2522V	2.00	7489	2.00	74LS30	.40	74L30	.40	74L165	2.50
MM5056	2.80	2525V	2.80	74200	4.95	74LS42	1.50	74L32	.45	74L192	1.25
MM5057	2.80	2527V	2.80	74S89	3.50	74LS55	.40	74L42	1.50	74L193	1.20
MM5058	3.50	2528V	2.80	74C89	3.50	74LS73	.65	74L51	.35	MC4044	2.25
MMS314	4.00	2529V	2.80	74L89	3.50	74LS74	.65	74L54	.45	N8264	3.50
MM5316	4.50	2532B	2.80	8223	2.50	74LS76	.65	74L55	.35	N8263	3.50
MM5320	5.95	2533V	2.80	F4702	17.00	74LS151	1.55	74L71	.30	N8826	2.50
MM5554	1.90	91L02APC	2.55	(baud rate gen)		74LS174	2.20	74L73	.55	DM8131	2.50
MM5555	2.50	32 each	2.40	2.4576 MHZ		74LS175	1.95	74L74	.55	8T37	2.50
MM5556	2.50	64 each	2.25	Crystal	8.95	74LS192	2.85	74L75	1.20	8T10	2.00

64 x 16 VIDEO BOARD Altair plug compatible display
32 x 16 or 64 x 16 switch selectable. Composite and parallel video ports, upper and lower case with software.
Kit\$179.95

Misc
Altair compatible mother board. Room for 15 connectors 11" x 11 1/2" (w/o connectors).....\$45
With 15 connectors.....\$111.00
Altair extender board (w/o connectors).....\$9
With w/w connector.....\$13.50

MODEMS \$85.00
1702A* EROM \$10.00
1702A* 2 usec "programming sendhexlist" 8.00
AY5-1013UART 5.00
2513 prime spec. upper or lowercase \$6.95
8080A prime CPU 11.00
8212 prime latch buffer 25.00
8224 prime clock gen 4.00
8228 prime sys controller 5.00
8.90

For large orders please send money order or cashiers check to avoid delays in waiting for checks to clear.

Check or money order only. Calif. resident 6% tax. All orders postpaid in U.S. All devices tested prior to sale. Money back 30 day guarantee. Sorry we can not accept returned IC's that have been soldered to. \$10 min. order. Prices subject to change without notice.

MIKOS

419 Portofino Dr.
San Carlos, Ca. 94070

Please send for xistor, IC & kit list

S.D. SALES CO.

P.O. BOX 28810 - B
DALLAS, TEXAS 75228

Z-80 CPU CARD KIT
FOR IMSAI/ALTAIR

\$149.^{KIT}

From the same people who brought you the \$89.95 4K RAM kit. We were not the first to introduce an IMSAI/ALTAIR compatible Z-80 card, but we do feel that ours has the best design and quality at the lowest price.

The advanced features of the Z-80 such as an expanded set of 158 Instructions, 8080A software compatibility, and operation from a single 5VDC supply, are all well known. What makes our card different is the extra care we took in the hardware design. The CPU card will always stop on an M1 state. We also generate TRUE SYNC on card, to insure that the rest of your system functions properly. Dynamic memory refresh and NMI are brought out for your use. Believe it or not, not all of our competitors have gone to the extra trouble of doing this.

As always, this kit includes all parts, all sockets, and complete instructions for ease of assembly. Because of our past experience with our 4K kit we suggest that you order early. All orders will be shipped on a strict first come basis. Dealers inquiries welcome on this item.

Kit shipped with 2 MHZ crystals for existing 500NS memory. Easily modified for faster RAM chips when the prices come down. Z-80 Manual - \$7.50 Separately.

Kit includes Zilog Manual and all parts.

JUMBO
LED
CAR
CLOCK

\$16.95
KIT

You requested it! Our first DC operated clock kit. Professionally engineered from scratch to be a DC operated clock. Not a makeshift kluge as sold by others. Features: Bowmar 4 digit .5 inch LED array, Mostek 50252 super clock chip, on board precision time base, 12 or 24 hour real time format, perfect for cars, boats, vans, etc. Kit contains PC Board and all other parts needed (except case). 50,000 satisfied clock kit customers cannot be wrong!

FOR ALARM OPTION ADD \$1.50
FOR XFMR FOR AC OPERATION ADD \$1.50

60 HZ CRYSTAL TIME BASE FOR DIGITAL CLOCKS
S.D. SALES EXCLUSIVE!

KIT FEATURES:

- A. 60HZ output with accuracy comparable to a digital watch.
- B. Directly interfaces with all MOS Clock Chips.
- C. Super low power consumption. (1.5 ma typ.) **\$5.95 or 2/\$10.**
- D. Uses latest MOS 17 stage divider IC.
- E. Eliminates forever the problem of AC line glitches.
- F. Perfect for cars, boats, campers, or even for portable clocks at ham field days.
- G. Small Size, can be used in existing enclosures.

KIT INCLUDES CRYSTAL, DIVIDER IC, PC BOARD
PLUS ALL OTHER NECESSARY PARTS & SPECS

50HZ CRYSTAL TIME BASE KIT - \$6.95

All the features of our 60HZ kit but has 50HZ output. For use with clock chips like the 50252 that require 50HZ to give 24 hour time format.

THIS MONTH'S SPECIALS!

- 300.00 KHZ CRYSTAL - \$1.50
- 8080A - CPU CHIP by AMD - \$19.95
- 82S129 - 256 x 4 PROM - \$2.50
- N.S. 8865 OCTAL DARLINGTON DRIVERS
3 for \$1.00
- Z-80 - CPU by ZILOG - \$69.95
- MM5204 - 4K EPROM - \$7.95

Prices in effect this month ONLY!

SPECIAL

SPECIAL

4K LOW POWER RAM BOARD KIT
THE WHOLE WORKS - \$89.95

Imsai and Altair 8080 plug in compatible. Uses low power static 21L02-1 500ns. RAM's, which are included. Fully buffered, drastically reduced power consumption, on board regulated, all sockets and parts included. Premium quality plated thru PC Board.

7400-19c	7411-29c	7451-19c	7490-65c	74153-75c
74LS00-49c	7413-50c	7453-19c	74LS90-95c	74154-1.00
7402-19c	7416-69c	7473-39c	7492-75c	74157-75c
74LS02-49c	7420-19c	7474-35c	7493-69c	74161-95c
7404-19c	7430-19c	74LS74-59c	7495-75c	74164-1.10
74L04-29c	7432-34c	7475-69c	7496-89c	74165-1.10
74S04-44c	7437-39c	7476-35c	74121-38c	74174-95c
74LS04-49c	7438-39c	7480-49c	741265c	7481-2.50
7406-29c	7440-19c	7483-95c	74132-1.70	74191-1.25
7408-19c	7447-85c	7485-95c	74S138-1.95	74192-1.25
7410-19c	7448-85c	7486-45c	74141-75c	74193-1.00
TTL INTEGRATED CIRCUITS				

STICK IT!
in your clock
in your DVM, etc.!

Huge Special Purchase
Not Factory Seconds
As sold by others!

\$3.95

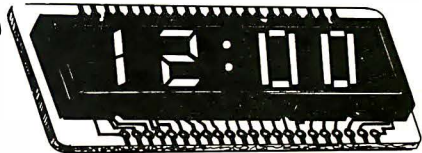

4 JUMBO .50"
DIGITS ON
ONE STICK!
(with colons and
AM/PM Indicator)

BUY 3 for \$10.

BOWMAR 4 DIGIT LED READOUT ARRAY

The Bowmar Opto-Stick. The best readout bargain we have ever offered. Has four common cathode jumbo digits with all segments and cathodes brought out. Increased versatility since any of the digits may be used independently to fit your applications. Perfect for any clock chip, especially direct drive units like 50380 or 7010. Also use in freq. counters, DVM's, etc. For 12 or 24 hour format.

UP YOUR COMPUTER!
21L02-1 1K LOW POWER 500 NS STATIC RAM
TIME IS OF THE ESSENCE!

And so is power. Not only are our RAM'S faster than a speeding bullet but they are now very low power. We are pleased to offer prime new 21L02-1 low power and super fast RAM's. Allows you to STRETCH your power supply farther and at the same time keep the wait light off. **8 for \$12.95**

\$12.95 S.D. SALES EXCLUSIVE! **\$12.95**
MOS 6 DIGIT UP-DOWN COUNTER

40 PIN DIP. Everything you ever wanted in a counter chip. Features: Direct LED segment drive, single power supply (12 VDC TYP.), six decades up/down, pre-loadable counter, separate pre-loadable compare register with compare output, BCD AND seven segment outputs, internal scan oscillator, CMOS compatible, leading zero blanking, 1MHZ. count input frequency. Very limited qty. WITH DATA SHEET

WESTERN DIGITAL UART

No. TR1602B. 40 pin DIP
This is a very powerful and popular part.
NEW-\$6.95 with data
LIMITED QUANTITY

SLIDE SWITCH
ASSORTMENT

Our best seller. Includes miniature and standard sizes, single and multi-position units. All new, first quality, name brand. Try one package and you'll reorder more. **SPECIAL 12/\$1.**

RESISTOR
ASSORTMENT

¼ W 5% and 10%
PC leads. A good mix of values. **200/\$2.**



1702A 2K ERASABLE
PROM'S - \$6.95

We tell it like it is. We could have said these were factory new, but here is the straight scoop. We bought a load of new computer gear that contained a quantity of 1702 A's in sockets. We carefully removed the parts, verified their quality, and are offering them on one heck of a deal. First come, first served. Satisfaction guaranteed! U.V. Eraseable. **\$6.95 each 4 for \$25**

MOTOROLA POWER
DARLINGTON
Back in Stock!

Like MJ3001. NPN 80V. 10A. HFE 6000 TYP. TO-3 case. We include a free 723C volt reg. with schematic for power supply. **SPECIAL-\$1.99**

CALL YOUR BANK
AMERICARD OR MASTER
CHARGE ORDER IN ON
OUR CONTINENTAL
UNITED STATES TOLL
FREE WATTS:

1-800-527-3460

Texas Residents Call Collect

214/271-0022

S.D. SALES CO.
P.O. BOX 28810 B
Dallas, Texas 75228

TERMS:

Money Back Guarantee. No COD. Texas Residents add 5% tax. Add 5% of order for postage and handling. Orders under \$10. add 75c. Foreign orders: US Funds ONLY!

For orders over \$15.00 Choose \$1.00 FREE mdse.

F8 EVALUATION BOARD KIT WITH EXPANSION CAPABILITIES

A fantastic bargain for only

with the following features:

- 20 ma of RS 232 interface
- 64K addressing range
- Program control timers
- 1K off on board static memory

\$99⁰⁰

- Built in clock generator
- 64 Byte register
- Built-in priority interrupts
- Documentation

GENERAL PURPOSE COMPUTER POWER SUPPLY KIT

This power supply kit features a high frequency torroid transformer with switching transistors in order to save space and weight. 115V 60 cycle primary. The outputs with local regulators are +5V at 10A, -5V at 1A, ±12V at 1A.

\$79⁰⁰

UNIVERSAL 4K x 8 MEMORY BOARD KIT

This memoryboard kit can be used with most microcomputers.

\$74⁵⁰

Some of the outstanding features are:

32-2102-1 static RAM's, 16 address lines, 8 data lines in, 8 data lines out, all buffered. On board decoding for any 4 of 64 pages.

4K F8 Basic \$25.00

2708-PROM	\$55.00
2522 STATIC SHIFT REG.	\$1.95
2518-HEX 32 BIT SR	\$3.50
2102-1 1024 BIT RAM	\$1.80
5280-4K DYNAMIC RAM	\$10.50
5202A UV PROM	\$10.50
MM5203 UV PROM	\$10.50
1702A UV PROM	\$10.75
5204-4K PROM	\$18.95
MINIATURE MULTI-TURN TRIM POTS 100, 500, 2K, 10K, 100K, 200K, 1 Meg. \$.75 each	3/\$2.00
MULTI-TURN TRIM POTS similar to Bourns 3010 style 3/16"x5/8"x1-1/4"; 50, 100, 1K, 10K, 50K ohms	3/\$4.00
LIGHT ACTIVATED SCR's TO-18, 200V 1A.	\$ 1.75

TRANSISTOR SPECIALS	
2N3585 NPN Si TO-66	\$.95
2N3772 NPN Si TO-3	\$ 1.60
2N4908 PNP Si TO-3	\$ 1.00
2N6056 NPN Si TO-3 Darlington	\$ 1.70
2N6086 PNP Si TO-92	4/\$ 1.00
2N4988 PNP TO-66	\$.60
2N404 PNP GE TO-5	5/\$ 1.00
2N3919 NPN Si TO-3 RF	\$ 1.50
MPSA 13 NPN Si TO-92	3/\$ 1.00
2N3767 NPN Si TO-66	\$.70
2N2222 NPN Si TO-18	5/\$ 1.00
2N3055 NPN Si TO-3	\$.80
2N3904 NPN Si TO-92	5/\$ 1.00
2N3906 PNP Si TO-92	5/\$ 1.00
2J5296 NPN Si TO-220	\$.50
2N6109 PNP Si TO-220	\$.55
2N3638 PNP Si TO-5	5/\$ 1.00
2N6517 NPN TO-92 Si	3/\$ 1.00

C/MOS (DIODE CLAMPED)	
74C02 -22	4015 -95 4035 -110
74C10 -22	4016 -40 4042 -78
74C193-150	4017 -105 4047 -200
4001 -22	4018 -100 4049 -40
4002 -22	4019 -25 4050 -40
4006 -120	4022 -35 4055 -150
4007 -40	4024 -75 4060 -30
4008 -42	4027 -40 4071 -22
4010 -42	4028 -88 4076 -70
4011 -22	4029 -110 4081 -22
4012 -22	4030 -22 4082 -115
4013 -40	

MCA-81 OPTICAL LIMIT SWITCH \$1.50	
LED READOUTS	
FND 500-.5" C.C.	\$1.75
HP 7740-.3" C.C.	\$1.40
MAN-7-.3" C.A.	\$1.25
NS 33-3 dig. array	\$1.25
DL 747	\$2.50

Send 25¢ for our catalog featuring Transistors and Rectifiers.
145 Hampshire St., Cambridge, Mass.

PRINTED CIRCUIT BOARD	
4-1/2"x6-1/2" SINGLE SIDED EPOXY BOARD 1/16" thick, unetched	\$5.00 ea.
5/\$2.20	

7 WATT LD-65 LASER DIODE, IR \$8.95	
2N 3820 P FET	\$.45
2N 5457 N FET	\$.45
TIS 43 UJT	\$.35
ER 900 TRIGGER DIODES	4/\$1.00
2N 6028 PROC. UJT	\$.65
8 PIN DIP SOCKETS	\$.24
14 PIN DIP SOCKETS	\$.25
16 PIN DIP SOCKETS	\$.28
18 PIN DIP SOCKETS	\$.30
24 PIN DIP SOCKETS	\$.40
40 PIN DIP SOCKETS	\$.60

VERIPAX PC BOARD	
This board is a 1/16" single sided paper epoxy board, 4"x6"; DRILLED and ETCHED which will hold up to 21 single 14 pin IC's or 8, 16, or LSI DIP IC's with buses for power supply connector. \$4.00	
MV 5691 YELLOW GREEN BIPOLAR LED	\$1.25
FP 100 PHOTO TRANS	\$.50
RED, YELLOW GREEN OR AMBER LARGE LED's	ea. \$.20
MOLEX PINS	100/\$1.50 1000/\$7.50
10 WATT ZENERS 3.9, 4.7, 5.6, 8.2, 12, 15, 18, 22, 100, 150 or 200V	ea. \$.60
1 WATT ZENERS 4.7, 5.6, 10, 12, 15, 18 OR 22V	ea. \$.25
MC6880 MODEM CHIP	\$13.00

Silicon Power Rectifiers	
PRV 1A 3A 12A 50A 125A	
100 .06 .14 .30 .80 3.70	
200 .07 .20 .35 1.15 4.25	
400 .09 .25 .50 1.40 6.50	
600 .11 .30 .70 1.80 8.50	
800 .15 .35 .90 2.30 10.50	
1000 .20 .45 1.10 2.75 12.50	

SILICON SOLAR CELLS	
2 1/2" diameter	
.4V at 500 ma. . . \$4.00 ea., 6/\$22.50	

REGULATED MODULAR POWER SUPPLIES	
±15 VDC AT 100ma	
115VAC INPUT	\$29.95
5VDC AT 1A, 115VAC INPUT	\$24.95
12 VDC AT .5 AMP	\$24.95
IN 414B (IN914)	15/\$100

TANTULUM CAPACITORS	
22UF 35V 5/\$1.00	4.7UF 35V 4/\$1.00
47UF 35V 5/\$1.00	6.8UF 35V 3/\$1.00
68UF 35V 5/\$1.00	22UF 35V \$.40
1UF 35V 5/\$1.00	33UF 35V \$.40
2.2UF 20V 5/\$1.00	30UF 6V 5/\$1.00
3.3UF 35V 4/\$1.00	100UF 35V \$.50
	150UF 15V \$.50
M7001 ALARM CLOCK CHIP	\$5.75

NATIONAL MOS DEVICES	
MM1402-1.75	MM5057-2.25
MM1403-1.75	MM5058-2.75
MM1404-1.75	MM5060-2.75
MM5013-2.50	MM5061-2.50
MM5016-2.50	MM5555-4.75
MM5017-2.70	MM5556-4.75
MM5055-2.25	MM5210-1.95
MM5056-2.25	MM5260-1.75

TTL IC SERIES		
7400 -15	7442 -52	74126 -40
7401 -15	7445 -70	74151 -70
7402 -15	7446 -70	74153 -65
7403 -15	7447 -70	74154 -110
7404 -20	7448 -70	74155 -70
7405 -20	7450 -20	74157 -70
7406 -25	7472 -33	74161 -85
7407 -25	7473 -35	74164 -95
7408 -25	7474 -35	74165 -105
7409 -21	7475 -49	74173 -140
7410 -15	7476 -35	74174 -95
7411 -20	7480 -35	74175 -92
7412 -20	7483 -70	74177 -79
7413 -45	7485 -88	74180 -70
7414 -70	7486 -30	74181 -210
7416 -25	7489 -185	74190 -120
7417 -25	7490 -45	74191 -120
7420 -20	7491 -70	74192 -85
7425 -28	7492 -50	74193 -85
7426 -25	7493 -45	74194 -85
7427 -30	7494 -70	74195 -75
7430 -20	7495 -70	74196 -88
7432 -25	7496 -70	74257 -125
7437 -25	74107 -32	74279 -90
7438 -25	74121 -38	75324 -1.75
7440 -16	74123 -65	75491 -65
7441 -85	74125 -40	75492 -65

MINIATURE DIP SWITCHES	
CTS-206-4 Four SPST switches in one minidip package.	\$1.75
CTS-206-8 Eight SPST switches in a 16 pin DIP package.	\$1.95

AV-5-1013-A30K ser./par., uni-versal UART.	\$6.95
--	--------

ALCO MINIATURE TOGGLE SWITCHES	
MTA 106 SPDT	\$1.20
MTA 206 DPDT	\$1.70

Full Wave Bridges	
PRV 2A 6A 25A	
200 .75	1.25 2.00
400 .95	1.50 3.00
600 1.20	1.75 4.00

SANKEN AUDIO POWER AMPS	
Si 1010 G 10 WATTS	\$ 7.95
Si 1020 G 20 WATTS	\$15.95
Si 1050 G 50 WATTS	\$27.95

CCD 110 LINEAR 256 XI BIT SELF SCANNING CHARGED COUPLED DEVICE	
CCD 201 . . . 100 x 100 CHARGE COUPLED DEVICE	\$135.00

LINEAR CIRCUITS	
LM307 - Op. Amp.	\$.30
LM309K 5V 1A REGULATOR	\$.95
723 - 40 + 40V V. REGULATOR	\$.50
301/748-Hi Per. Op. Amp.	\$.31
3207 5, 12, 15, or 24V NEG REG.	\$1.25
709C - Op. Amp.	\$.31
741A or 741C OP AMP.	\$.31
710 COMPARATOR	\$.35
CA 3047 Hi Per. Op. Amp.	\$.95
3407 5, 6, 8, 12, 15, 18, 24V POS REG. TO-220	\$1.10
101 OPER. AMP. HI PERFORM.	\$.75
LM308 Oper. Amp., Low Power	\$.95
747 - DUAL 741	\$.65
556 - DUAL TIMER	\$1.00
537 - PRECISION OP. AMP.	\$1.70
LM3900 - QUAD OP. AMP.	\$.49
LM324 - QUAD 741	\$1.50
550 - PHASE LOCK LOOP	\$2.00
561 - PHASE LOCK LOOP	\$2.00
565 - PHASE LOCK LOOP	\$1.25
566 FUNCTION GEN.	\$1.65
567 - TONE DECODER	\$1.50
LM1301N FM STEREO DEMOD.	\$2.75
8038 IC VOLTAGE CONT. OSC.	\$3.90
LM370 - AGC SQUELCH AMP.	\$1.15
555 - 2's - 2 HR. TIMER	\$.85
553 AUDIO TIMER	\$2.50
FCD 810 OPTO-ISOLATOR	\$.80
1458 DUAL OP. AMP.	\$.60
LM380 - 2W AUDIO AMP.	\$.95
LM377 - 2W Stereo Audio Amp.	\$2.50
LM381 - STEREO PREAMP.	\$1.50
LM382 - DUAL AUDIO PREAMP	\$1.50
LM311 - HI PER. COMPARATOR	\$.90
LM319 - Quad/Hi Speed Comp.	\$1.25
LM339 - DUAL COMP. COMP.	\$1.50

TRIACS	
PRV 1A 10A 25A 1.5A 6A 35A	
100 .40	.70 1.30 .40 .50 1.20
200 .70	1.10 1.75 .60 .70 1.60
400 1.10	1.60 2.60 1.00 1.20 2.20
600 1.70	2.30 3.60 1.50 3.00

SCR'S	
PRV 1A 10A 25A 1.5A 6A 35A	
100 .40	.70 1.30 .40 .50 1.20
200 .70	1.10 1.75 .60 .70 1.60
400 1.10	1.60 2.60 1.00 1.20 2.20
600 1.70	2.30 3.60 1.50 3.00

Terms: FOB Cambridge, Mass. Send Check or Money Order. Include Postage, Minimum Order \$5.00, COD'S \$20.00



SOLID STATE SALES

P.O. BOX 74B
SOMERVILLE, MASS. 02143 TEL. (617) 547-4005

WESHUP OVER 95% OF OUR ORDERS THE DAY WE RECEIVE THEM

- Accuracy: $\pm 0.05\%$ of Reading ± 1 Count
- Two Voltage Ranges: 1.999 V and 199.9 mV
- Up to 25 Conversions/s
- $Z_{in} > 1000$ M ohm
- Auto Polarity and Auto-Zero
- Single Positive Voltage Reference
- Standard B-Series CMOS Outputs—Drives One Low Power Schottky Load
- Uses On-Chip System Clock, or External Clock
- Low Power Consumption: 8.0 mW typical @ ± 5.0 V
- Wide Supply Range: e.g. ± 4.5 V to ± 8.0 V

MC14433 SINGLE CHIP $3\frac{1}{2}$ DIGIT A/D

Single chip combines linear and CMOS digital to bring you the simplest yet DVM approach. Requiring only 4 external passive parts, this subsystem gives you: Auto polarity, auto zero, single voltage reference, 8 mW operation, overrange, under-range signals, 25 conversions per second and $.05\% \pm 1$ count accuracy! 100 uV resolution. 24 Pin DIP.
MC14433P.....with specs.....\$19.55

MC14412 UNIVERSAL MODEM CHIP

MC14412 contains a complete FSK modulator and de-modulator compatible with foreign and USA communications. (0-600 BPS)

FEATURES:

- On chip crystal oscillator
- Echo suppressor disable tone generator
- Originate and answer modes
- Simplex, half-duplex, and full duplex operation
- On chip sine wave
- Modem self test mode
- Selectable data rates: 0-200
0-300
0-600

- Single supply
VDD=4.75 to 15VDC - FL suffix
VDD=4.75 to 6 VDC - VL suffix

TYPICAL APPLICATIONS:

- Stand alone - low speed modems
- Built - in low speed modems
- Remote terminals, acoustic couplers

MC14412FL.....	\$28.99
MC14412VL.....	\$21.74
6 pages of data.....	.60
Crystal for the above.....	\$4.95

MC14411 BIT RATE GENERATOR.

Single chip for generating selectable frequencies for equipment in data communications such as TTY, printers, CRT's or microprocessors. Generates 14 different standard bit rates which are multiplied under external control to 1X, 8X, 16X or 64X initial value. Operates from single ± 5 volt supply. MC14411.....\$11.98
4 pages of data.....\$4.00
Crystal for the above.....\$4.95

REMOTE CONTROL TRANSMITTER. MC14422P is a 22 channel ultra-sonic remote control transmitter I.C. CMOS uses little power and only a few external passive components. Applications include TV receivers, security controls, toys, industrial controls and locks. 16 pin DIP plastic pkg.
MC14422P..... with specs.....\$11.10



MC6525 REMOTE CONTROL RECEIVER

The MC6525 is a 22-channel remote control receiver circuit designed for use in television receivers, industrial remote controls, remote security controls, radio receivers, electronic games and similar applications. The circuit is intended for use with the MC14422 remote control transmitter. Comes in 28 pin DIP plastic package.
MC6525P.....with 6 pages of specs.....\$18.38

3 DECADE (BCD) COUNTER CHIP

MC14553BCP consists of 3 negative edge triggered synchronous counters, 3 quad latches and self scan multiplexed, TTL compatible outputs.
MC14553BCP.....\$8.72
Spec sheets.....\$6.00

LM1889 TV VIDEO MODULATOR

The LM1889 is designed to interface audio, color difference, and luminance signals to the antenna terminals of a TV receiver. It consists of a sound subcarrier oscillator, chroma subcarrier oscillator, quadrature chroma modulators, and R-F oscillators and modulators for two low-VHF channels. The LM1889 allows video information from VTR's, games, test equipment, or similar sources to be displayed on black and white or color TV receivers.
LM1889 with 16 pages of data \$9.95, data only, \$1.00



AMP LANNY

Says

IF YOUR PROJECT TIME AND MONEY ARE BEING BLOWN AWAY BY DELAYS AND HIGH PRICES---
***** MARCH ON DOWN TO TRI-TEK! *****

OK MACHINE AND TOOL CORPORATION

HOBBY-WRAP TOOL

HOBBY-WRAP TOOL

Battery operated with built-in 30 ga bit and sleeve. Uses standard C batteries (not included). Light weight, only 11 oz. Wraps standard DIP sockets. Has built in device to prevent overwrapping. Pistol grip, positive indexing. Quality construction assures exceptional performance. BW-630.....\$34.95
FREE, a 50' roll of wire wrap wire with each tool!!!

HOBBY-WRAP-30 Handy little tool to strip, wrap and unwrap 30 gauge wire.....\$5.95

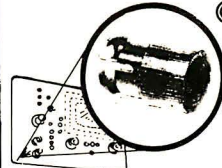

CLIPLITE™
COMBINATION LENS AND MOUNTING DEVICE FOR T 1-3/4 LED

REQUIRES NO TOOLS

SNAP CLIPLITE

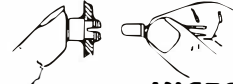

INSERT LED

AVAILABLE IN TRANSPARENT RED - GREEN - AMBER - CLEAR & YELLOW

CLIPLITE

Combination lens and mounting device for T 1-3/4 LED. The CLIPLITE combines the benefits of the present LED display panel mounting methods and eliminates their deficiencies. Requires no special tools and installs in 6 seconds in .250" hole. Simple two-step installation. Just snap CLIPLITE, insert LED. Available in transparent red, green, amber, clear and yellow. Specify colors, any mix.
5/\$1.00, 10/\$1.90, 20/\$3.50, 50/\$7.50, 100/\$13.50

78H12 HIGH CURRENT REGULATOR

Now, a 12V, 5A regulator in a single TO-3 package!! Internal short circuit limit and thermal overload protection. Some ease of application as the popular 309K
78H12.....with specs.....\$14.25

SN75450 DUAL PERIPHERAL DRIVER

Two identical NAND gates and two 30V, 300mA unconnected NPN transistors in a 14 pin DIP package. Use for lamp and LED drivers, cable drivers, relays-----etc.
SN75450N.....45c, 10/\$3.90

5V, 3Amp O.E.M. Power Supply. Adjustable current limit. Super good specs.....\$29.95

FIXED VOLTAGE 1 AMP REGULATORS

+5V in TO-3.....	.98c
+5V in TO-220 Power Tab.....	.95c
+12V in TO-3.....	\$1.19
+12V in TO-220 Power Tab.....	\$1.09
+15 in TO-3.....	\$1.19
+15V in TO-220 Power Tab.....	\$1.09

TL430CLP PROGRAMMABLE ZENER

Brand new device type allows you to make your own zener by external programming. Turn those cheap fixed voltage regulators into rock solid adjustable by adding this little feller, 1 resistor and a pot. Use for min/max indicators, settable crowbar, shunt regulator, clamp. Be the first one on your block to use this new and interesting part.
TL430CLP.....\$1.00
Specs and applications......30c

93S41 SUPER FAST 4-BIT ALU

All 16 possible logic operations on two variables plus arithmetic. Schottky diodes on input for high speed. Same as 74S181.
93S41.....\$1.98, 4/\$6.00



DATA BOOKS BY NATIONAL SEMICONDUCTOR

DIGITAL. Covers TTL, DTL, Tri-State, etc.....\$3.95
LINEAR. Covers amplifiers, pre-amps, op-amps... \$4.25
LINEAR APPLICATIONS VOLUME I. Dozens of application notes and technical briefs covering the use of op-amps, regulators, phase locked loops and audio amps..... \$3.25
LINEAR APPLICATIONS VOLUME II. Takes up where Volume I left you--All the latest linear devices. Along with Vol I you have a great source of application data on the most widely used devices as well as new types just appearing.....\$3.25
CMOS. Gates, Flip Flops, registers, etc.....\$3.00
VOLTAGE REGULATORS. A must for anyone making a power supply. Complete theory including transformers, filters, heat sinks, regulators etc..... \$3.00
MEMORY. Info on MOS and Bipolar memories, RAMS, ROMS, PROMS and decoder/encoders..... \$3.95
INTERFACE. Covers peripheral drivers, level translators, line driver/receivers, memory and clock drivers, sense amps, display driver and opto-couplers.... \$3.95
SPECIAL FUNCTIONS DATA BOOK. Contains detailed information for specifying and applying special amplifiers, buffers, clock drivers, analog switches and D/A-A/D converter products..... \$3.25
AUDIO HANDBOOK Contains detailed discussions, including complete design particulars, covering many areas of audio with real world design examples... \$3.25
-----SPECIAL-----
DATA BOOKSHELF. Buy all ten of the National Data books at one time and save \$5.10!!!!.....\$30.00 (All books shipped ppd in US only. Foreign orders please add shipping for 1.5 lbs per book)



TRI-tek, inc.

6522 NORTH 43RD AVENUE.
GLENDALE, ARIZONA 85301
phone 602 - 931-6949

We pay surface shipping on all orders over \$10 US, \$15 foreign in US funds. Please add extra for first class or air mail. Excess will be refunded. Orders under \$10, odd \$1 handling. Please add 50c insurance. Master charge and Bank America cards welcome, (\$20 minimum). Telephone orders may be placed 10AM to 5:30PM daily, Mon thru Fri. Call 602-931-4528. Check reader service card or send stamp for our latest flyers packed with new and surplus electronic components.

Reader Service

*Reader service inquiries not solicited.
Correspond directly with company.

To get further information on the products advertised in BYTE, fill out the reader service card with your name and address. Then circle the appropriate numbers for the advertisers you select from this list. Add a 9 cent stamp to the card, then drop it in the mail. Not only do you gain information, but our advertisers are encouraged to use the marketplace provided by BYTE. This helps us bring you a bigger BYTE.

Reader Service Number	Page Number	Reader Service Number	Page Number	Reader Service Number	Page Number
75	Advanced Microcomputer Prods 147	56	E&L Instruments 95	64	Oliver Audio Engineering 139
173	Anderson Jacobson 143	102	Eltron 151	198	Omni 103
4	BITS Inc 86, 87	9	Godbout 152	63	Parasitic Engineering 129, 133
153	Bits, Bytes and Pieces 141	69	HAL Communications 97	*	PerCom Data 96
*	BYTE's Binders 136	55	Heath Co 103	194	Peripheral Vision 81
200	California Industrial 148	109	iCOM 61	*	Polymorphic Systems 25
126	Cheap Inc 141	12	IMSAI 15	213	Prime Radix 127
127	Comptek 135	204	International Data Systems 101	24	Processor Technology 5, 6, 7, 8, 9, 63
140	Computalker 141	15	James 153, 154	167	Quay 98, 99
*	Computer Faire 68, 69	130	JGM Development Labs 139	201	Riverside Electronics 105
83	Computer Mart NY LI 141	90	Logical Services 139	26	Scelbi 29
156	Computer Place 143	209	Logic Designs Inc 117	*	Scientific Research 65
141	Computer Room 89	124	McGraw-Hill 27	27	SD Sales 157
208	Computer Shack 83	18	Meshna 155	169	Smoke Signal Broadcasting 135
206	Computer System Design 139	196	Micronics 141	59	Solid State Sales 158
203	Computer Systems 66	77	Micro-Term 131	29	Southwest Tech CII
197	Computer Systems Center SL 141	174	Microtex 139	99	STM 145
199	Computer Transceivers 137	119	Midwestern Sci Inst 138	164	Sunny Computer Stores 143
138	Computer Warehouse 149	57	Mikos 156	96	Synchro-Sound Enterprises 79
202	CRC Engineering 133	112	MiniTerm 67	205	Szerlip Enterprises 121
87	Creative Computing 134	*	MITS CIV, 84, 85	121	Tarbell Electronics 125
41	Cromemco 1, 2	62	Morrow 145	82	Technical Design Labs 49
178	Cybercom 11	71	mpi 121	136	Technical Systems Consultants 137
185	DAJEN Electronics 66	132	M&R Enterprises 143	192	Tec Mar 119
78	Digital Group 17	171	Mullen 131	32	Tri Tek 159
210	M W Dunton 66	*	National Computer Conf 132	212	University of Texas 143
170	ECD CIII	22	National Multiplex 37	193	US Robotics 143
211	Economy Terminal 129	155	North Star Computers 93	137	Vector Graphic 12, 13, 35
47	Electronic Control Tech 139	40	Ohio Scientific Instr 33	154	Worldwide Electronics 91
157	Electronic Warehouse 150				

BOMB— BYTE's Ongoing Monitor Box

On BOMB Card,
Article No.

ARTICLE

PAGE

1	Grappel: Give Your Micro Some Muscles	9
2	Kay: PR-40 Alphanumeric Printer Review	18
3	Freeman: Cassette Transports for "Roll Your Own"	26
4	Bremer-Rampil: Digital Cassette Subsystem, Part 2	38
5	Frenzel: What's Involved in Kit Building?	50
6	Burhans: Simplified Omega Receiver Details	70
7	Buschbach: Inexpensive Joystick Interfaces	88
8	Price: Flights of Fancy with the Enterprise	106
9	Ciarcia: Try This Computer on for Size	114
10	Hogenson: Multiplex Your Digital LED Displays	122

BOMB's Best Liked for December:
Cybernetic Crayon, Weather Predicting

Thomas A Dwyer and Leon Sweer of the Soloworks Lab at the University of Pittsburgh will share the \$100 bonus for the readers' most favored article in December 1976 BYTE, "The Cybernetic Crayon." Michael R Firth takes a \$50 prize for "Do It Yourself Weather Predictions," the runner-up. December's contest was the last of the "old fashioned" BOMBs, with voting done by photocopying or tearing out part of the last page. Now you can vote for your favorite articles by using the BOMB card inside this BYTE; just get it in before April 10 1977, the deadline for March entries. ■

BOMB: BYTE's Ongoing Monitor Box

Article No. Couldn't Care Less My Personal Rating Liked Somewhat Wow!

1	0	1	2	3	4	5	6	7	8	9	10
2	0	1	2	3	4	5	6	7	8	9	10
3	0	1	2	3	4	5	6	7	8	9	10
4	0	1	2	3	4	5	6	7	8	9	10
5	0	1	2	3	4	5	6	7	8	9	10
6	0	1	2	3	4	5	6	7	8	9	10
7	0	1	2	3	4	5	6	7	8	9	10
8	0	1	2	3	4	5	6	7	8	9	10
9	0	1	2	3	4	5	6	7	8	9	10
10	0	1	2	3	4	5	6	7	8	9	10
11	0	1	2	3	4	5	6	7	8	9	10
12	0	1	2	3	4	5	6	7	8	9	10
13	0	1	2	3	4	5	6	7	8	9	10
14	0	1	2	3	4	5	6	7	8	9	10
15	0	1	2	3	4	5	6	7	8	9	10
16	0	1	2	3	4	5	6	7	8	9	10
17	0	1	2	3	4	5	6	7	8	9	10
18	0	1	2	3	4	5	6	7	8	9	10
19	0	1	2	3	4	5	6	7	8	9	10
20	0	1	2	3	4	5	6	7	8	9	10
21	0	1	2	3	4	5	6	7	8	9	10
22	0	1	2	3	4	5	6	7	8	9	10
23	0	1	2	3	4	5	6	7	8	9	10
24	0	1	2	3	4	5	6	7	8	9	10
25	0	1	2	3	4	5	6	7	8	9	10

..... Comments

Please allow eight weeks for processing.

BYTE SUBSCRIPTIONS

For a subscription to BYTE, please complete this form.

Name _____
 (Title, optional) _____
 (Company, optional) _____
 Address _____
 City _____ State _____ Zip _____

Please check:

- 1 year \$12
- 2 years \$22
- 3 years \$30
- Lifetime \$150
- Check enclosed
- Bill me
- Bill BAC # _____
- Bill MC # _____

Thank You



BYTE READER SERVICE

For fastest service transfer mailer label from wrapper to space provided below. Requests cannot be honored unless zip code is given.

Name _____
 (Title) _____
 (Company) _____
 Address _____
 City _____ State _____ Zip _____

NOTE—If label is missing or defaced fill out carefully—PLEASE PRINT—this is only way to get requested material to you.

1	31	61	91	121	151	181	211	241	271	301	331	361	391	421	451	481	511	541	571	601	631
2	32	62	92	122	152	182	212	242	272	302	332	362	392	422	452	482	512	542	572	602	632
3	33	63	93	123	153	183	213	243	273	303	333	363	393	423	453	483	513	543	573	603	633
4	34	64	94	124	154	184	214	244	274	304	334	364	394	424	454	484	514	544	574	604	634
5	35	65	95	125	155	185	215	245	275	305	335	365	395	425	455	485	515	545	575	605	635
6	36	66	96	126	156	186	216	246	276	306	336	366	396	426	456	486	516	546	576	606	636
7	37	67	97	127	157	187	217	247	277	307	337	367	397	427	457	487	517	547	577	607	637
8	38	68	98	128	158	188	218	248	278	308	338	368	398	428	458	488	518	548	578	608	638
9	39	69	99	129	159	189	219	249	279	309	339	369	399	429	459	489	519	549	579	609	639
10	40	70	100	130	160	190	220	250	280	310	340	370	400	430	460	490	520	550	580	610	640
11	41	71	101	131	161	191	221	251	281	311	341	371	401	431	461	491	521	551	581	611	641
12	42	72	102	132	162	192	222	252	282	312	342	372	402	432	462	492	522	552	582	612	642
13	43	73	103	133	163	193	223	253	283	313	343	373	403	433	463	493	523	553	583	613	643
14	44	74	104	134	164	194	224	254	284	314	344	374	404	434	464	494	524	554	584	614	644
15	45	75	105	135	165	195	225	255	285	315	345	375	405	435	465	495	525	555	585	615	645
16	46	76	106	136	166	196	226	256	286	316	346	376	406	436	466	496	526	556	586	616	646
17	47	77	107	137	167	197	227	257	287	317	347	377	407	437	467	497	527	557	587	617	647
18	48	78	108	138	168	198	228	258	288	318	348	378	408	438	468	498	528	558	588	618	648
19	49	79	109	139	169	199	229	259	289	319	349	379	409	439	469	499	529	559	589	619	649
20	50	80	110	140	170	200	230	260	290	320	350	380	410	440	470	500	530	560	590	620	650
21	51	81	111	141	171	201	231	261	291	321	351	381	411	441	471	501	531	561	591	621	651
22	52	82	112	142	172	202	232	262	292	322	352	382	412	442	472	502	532	562	592	622	652
23	53	83	113	143	173	203	233	263	293	323	353	383	413	443	473	503	533	563	593	623	653
24	54	84	114	144	174	204	234	264	294	324	354	384	414	444	474	504	534	564	594	624	654
25	55	85	115	145	175	205	235	265	295	325	355	385	415	445	475	505	535	565	595	625	655
26	56	86	116	146	176	206	236	266	296	326	356	386	416	446	476	506	536	566	596	626	656
27	57	87	117	147	177	207	237	267	297	327	357	387	417	447	477	507	537	567	597	627	657
28	58	88	118	148	178	208	238	268	298	328	358	388	418	448	478	508	538	568	598	628	658
29	59	89	119	149	179	209	239	269	299	329	359	389	419	449	479	509	539	569	599	629	659
30	60	90	120	150	180	210	240	270	300	330	360	390	420	450	480	510	540	570	600	630	670

MENTION **BYTE** WHEN WRITING TO ADVERTISERS

PLACE
STAMP
HERE

BYTE READER SERVICE
Publications Inc
70 Main St
Peterborough NH 03458

PLACE
STAMP
HERE

BYTE SUBSCRIPTIONS
Publications Inc
70 Main St
Peterborough NH 03458

PLACE
STAMP
HERE

BCME -
BYTE's Ongoing Monitor. Etc.

BYTE Publications Inc
70 Main St
Peterborough NH 03458

Now you can buy an Altair™ 8800b or an Altair 680b computer right off the shelf. Altair plug-in boards, peripherals, software and manuals are also available. Check the list below for the MITS dealer in your area.



off the shelf.

ALTAIR COMPUTER CENTER
8105 SW Nimbus Ave.
BEAVERTON, OR 97005

COMPUTER KITS (S.F. area)
1044 University Ave.
BERKELEY, CA 94710
(415)-845-5300

THE COMPUTER STORE
(Arrowhead Computer Co.)
820 Broadway
SANTA MONICA, CA 90401
(213)-451-0713

GATEWAY ELECTRONICS, INC.
OF COLORADO
2839 W. 44th Ave.
DENVER, CO 80211
(303)-458-5444

COMPUTER SHACK
3120 San Mateo N.E.
ALBUQUERQUE, NM 87110
(505)-883-8282; 883-8283

ALTAIR COMPUTER CENTER
4941 East 29th St.
TUCSON, AZ 85711
(602)-748-7363

ALTAIR COMPUTER CENTER
611 N. 27th St. Suite 9
LINCOLN, NB 68503
(402) 474-2800

COMPUTER PRODUCTS UNLIMITED
2412 Broadway
LITTLE ROCK, AR 72206
(501)-371-0449

ALTAIR COMPUTER CENTER
110 The Annex
5345 East Forty First St.
TULSA, OK 74135
(918)-684-4564

ALTAIR COMPUTER CENTER
5750 Bintliff Drive
HOUSTON, TX 77038
(713)-780-8981

COMPUTERS-TO-GO
4503 West Broad St.
RICHMOND, VA 23230
(804)-335-5773

MICROSYSTEMS (Washington, D.C.)
6605A Backlick Rd.
SPRINGFIELD, VA 22150
(703)-569-1110

THE COMPUTER STORE
Suite 5
Municipal Parking Building
CHARLESTON, W. VA. 25301
(304)-345-1360

THE COMPUTER ROOM
3938 Beau D'Rue Drive
EAGAN, MN 55122
(612)-452-2567

THE COMPUTER STORE
OF ANN ARBOR
310 East Washington Street
ANN ARBOR, MI 48104
(313)-995-7616

THE COMPUTER STORE, INC.
(Hartford area)
63 South Main Street
WINDSOR LOCKS, CT 06096
(203)-627-0188

CHICAGO COMPUTER STORE
517 Telcott Rd.
PARK RIDGE, IL 60066
(312)-823-2388

GATEWAY ELECTRONICS, INC.
8123-25 Page Blvd.
ST. LOUIS, MO 63130
(314)-427-6116

BYTE'TRONICS
Suite 103
1600 Hayes St.
NASHVILLE, TN 37203
(615)-329-1979

THE COMPUTER STORE, INC.
120 Cambridge St.
BURLINGTON, MA 01803
(617)-272-8770

ALTAIR COMPUTER CENTER
269 Osborne Road
ALBANY, NY 12211
(518)-459-6140

THE COMPUTER STORE
OF NEW YORK
55 West 39th St.
NEW YORK, NY 10018
(212)-221-1404

THE COMPUTER SYSTEMCENTER
3330 Piedmont Road
ATLANTA, GA 30305
(404)-231-1691

MARSH DATA SYSTEMS
5405 B Southern Comfort Blvd.
TAMPA, FL 33614
(813)-886-9890

